

NOAA
FISHERIES

Alaska Fisheries Science Center
Fisheries Monitoring and Analysis Division

North Pacific Observer Program

October 27, 2023



2024 OBSERVER SAMPLING MANUAL

**Observers: Keep this manual throughout the 2024 Fishing year
Cover photo by Brendan Moyer**

PAPERWORK REDUCTION ACT STATEMENT:

Information collected through the observer program will be used to: (1) monitor catch and bycatch; (2) understand the population status and trends of fish stocks and protected species, as well as the interactions between them; (3) determine the quantity and distribution of net benefits derived from living marine resources; (4) predict the biological, ecological, and economic impacts of existing management actions and proposed management options; and (5) ensure that the observer programs can safely and efficiently collect the information required for the previous four uses. In particular, the observer program provides information that is used in analyses that support the conservation and management of living marine resources and that are required under the Magnuson-Stevens Fishery Conservation and Management Act (MSA), the Endangered Species Act (ESA), the Marine Mammal Protection Act (MMPA), the National Environmental Policy Act (NEPA), the Regulatory Flexibility Act (RFA), Executive Order 12866 (EO 12866), and other applicable law. Most of the information collected by observers is obtained through “direct observation by an employee or agent of the sponsoring agency or through non standardized oral communication in connection with such direct observations.” Under the Paperwork Reduction Act (PRA) regulations at 5 C.F.R. 1320.3(h)(3), facts or opinions obtained through such observations and communications are not considered to be “information” subject to the PRA. The public reporting burden for responding to the questions that observers ask and that are subject to the PRA is estimated to average 60 minutes per trip, including the time for hearing and understanding the questions, searching existing data sources, gathering and maintaining the data needed, and completing and reviewing the collection of information. Send comments regarding this burden estimate or any other aspect of this collection of information, including suggestions for reducing this burden, to: National Marine Fisheries Service, Alaska Fisheries Science Center, Fisheries Monitoring and Analysis Division, 7600 Sandpoint Way NE, Seattle, WA 98115. Providing the requested safety information is mandatory under regulations at 50 C.F.R. 600.746; however, providing the other requested information is voluntary. All information collected by observers will be kept confidential as required under Section 402(b) of the MSA (18 U.S.C. 1881a(b)) and regulations at 50 C.F.R. Part 600, Subpart E. Notwithstanding any other provision of the law, no person is required to respond to, nor shall any person be subject to a penalty for failure to comply with a collection of information subject to the requirements of the Paperwork Reduction Act, unless that collection of information displays a currently valid OMB Control Number.

This document should be cited as follows:

(AFSC) Alaska Fisheries Science Center. 2024 Observer Sampling Manual. Fisheries Monitoring and Analysis Division, North Pacific Groundfish Observer Program. AFSC, 7600 Sand Point Way N.E., Seattle, Washington, 98115.

Reference in this document to trade names does not imply endorsement by the National Marine Fisheries Service, NOAA.

INTRODUCTION

Table of Contents

| | |
|--|------|
| The Observer Program | 1-1 |
| The Magnuson-Stevens Act | 1-2 |
| Vessel and Plant Descriptions | 1-3 |
| Management Plans | 1-3 |
| Time-Area Closures | 1-4 |
| Limited Access Privilege Programs | 1-4 |
| Other Management Agencies | 1-4 |
| Certification and Endorsements | 1-4 |
| Initial Training | 1-4 |
| Briefings | 1-5 |
| Additional Trainings and Briefings | 1-5 |
| Deployment | 1-6 |
| Personal Equipment | 1-6 |
| Sampling Equipment | 1-6 |
| Mid-cruise and Field Support | 1-9 |
| Debriefing | 1-10 |

THE OBSERVER PROGRAM

The Fisheries Monitoring and Analysis Division’s (FMA) North Pacific Observer Program (Observer Program) collects, maintains, and distributes data for scientific, management, and regulation compliance purposes in the Gulf of Alaska (GOA) and the Bering Sea/Aleutian Islands (BSAI). The FMA division is a component of the Alaska Fisheries Science Center (AFSC) of the National Marine Fisheries Service (NMFS). The parent agency for NMFS is the National Oceanic and Atmospheric Administration (NOAA), and NMFS is often referred to as NOAA Fisheries.

The Observer Program deploys over 400 certified groundfish observers each year on a variety of commercial fishing vessels. These observers, in turn, provide the Observer Program with over 46,000 data collection days annually. All covered vessels and processors in the groundfish and halibut fisheries off Alaska are placed into a full coverage sector and a partial coverage sector.

An observer’s job is unique, challenging and constantly changing. This manual is an indispensable tool both for trainees and experienced observers. It should be used as both a text book for trainees and a field reference manual for observers at sea. It contains the background, procedures, and protocols on how to collect the wide

variety of information requested; and some ideas on how to cope with specific situations. The methods described in this manual have been tested and modified throughout the North Pacific Observer Program’s existence, and will continue to be refined using observer feedback and suggestions. For additional information about observer resources, go to the North Pacific Observer Program website located at <https://www.fisheries.noaa.gov/alaska/fisheries-observers/north-pacific-observer-program>.



THE MAGNUSON-STEVENSONS ACT

With the passage of the Magnuson Fishery Conservation and Management Act in 1976, the U.S. declared management authority over fish resources within 200 nautical miles from their shores - the Exclusive Economic Zone (EEZ). The goals of the Magnuson Act were to

Americanize the fishery, implement fishery management plans, and to maintain optimum yield (OY) of the resource while rebuilding depleted groundfish stocks. This act was re-authorized in 1996 as the Magnuson-Stevens Fishery Conservation and Management Act; the Act was reauthorized again in 2006.

| Acronyms | Acronyms |
|--|--|
| ABC- Acceptable Biological Catch | LOA - Length Overall |
| ADF&G- Alaska Department of Fish and Game | MARPOL- Marine Pollution |
| AFA- American Fisheries Act | MRA- Maximum Retainable Amounts (was Maximum Retainable Bycatch) |
| AFSC- Alaska Fisheries Science Center | MSFCMA- Magnuson-Stevens Fishery Conservation and Management Act |
| ALT- Alaska Local Time | MSY- Maximum Sustainable Yield |
| BBL- The Bird Banding Laboratory of the U.S. Geological Survey | NMFS- National Marine Fisheries Service |
| BSAI- Bering Sea & Aleutian Islands | MML- Marine Mammal Laboratory |
| CA - Catch Accounting | NOAA- National Oceanic and Atmospheric Administration |
| CDP- Community Development Plan | NORPAC- North Pacific database (Observer Program database) |
| CDQ- Community Development Quota | NPFMC- North Pacific Fishery Management Council |
| CFR- Code of Federal Regulations | NSR- Non-Specific Reserve |
| CP- Catcher/Processor | OFL- Over Fishing Limit |
| CPR- Cardiopulmonary Resuscitation | OHF- Observer Haul Form |
| CPUE- Catch Per Unit Effort | OY- Optimum Yield |
| CV- Catcher Vessel | PCTC - Pacific Cod Trawl Cooperative |
| DCPL- Daily Cumulative Production Logbook | PFD- Personal Flotation Device |
| EEZ- Exclusive Economic Zone | PLT- Pacific Local Time |
| EPIRB- Emergency Position Indicating Radio Beacon | PRR- Product Recovery Rate |
| FCC- Federal Communications Commission | PSC- Prohibited Species Catch |
| FMA - Fisheries Monitoring and Analysis Division | PSQ- Prohibited Species Quota (for CDQ) |
| FMP- Fishery Management Plan | RBT- Random Break Table |
| FUS- Fully Utilized Species | RKCSA- Red King Crab Savings Area |
| GOA- Gulf of Alaska | RST- Random Sample Table |
| GPS- Global Positioning System | RSW- Refrigerated Sea Water |
| IFQ- Individual Fishing Quota | SSB- Single Side Band radio |
| IPHC- International Pacific Halibut Commission | TAC- Total Allowable Catch |
| IR/IU- Improved Retention/Improved Utilization | USCG- United States Coast Guard |
| IRCS- International Radio Call Sign | VHF- Vessel Haul Form (or Very High Frequency radio) |

Figure 1-1: Commonly Used Abbreviations and Acronyms

Additionally, the Magnuson Act established eight regional councils to manage the nation's fisheries. The North Pacific Fishery Management Council (the Council) has jurisdiction over the 900,000 square mile EEZ off the coast of Alaska.

By 1991, all foreign commercial fishing within the 200 mile EEZ was terminated, leaving an entirely domestic fishery. As the fisheries changed, so did the Observer Program. The Council implemented the domestic North Pacific Observer Program to gather data needed to manage the wide variety of fisheries off the coast of Alaska.

VESSEL AND PLANT DESCRIPTIONS

The North Pacific groundfish fishery is harvested by a variety of gear types, but most observer trips occur on one of three types: pot, longline, or trawl. Within these three gear types, there are two vessel types: catcher vessels (CVs) and catcher processors (CPs). Catcher vessels are boats that do not process their catch. Fish are caught, brought aboard, and stored in tanks until the vessel delivers to a processing plant. The majority of catcher boats use refrigerated sea water (RSW) to keep their catch fresh until delivery, but a few use ice. Catcher processors have factories and freezers aboard. They make a preliminary or finished product, and store it in large freezer holds. It is the ability to freeze fish that differentiates CPs from catcher boats, and a vessel which freezes whole fish is still considered a CP.

Pot Vessels

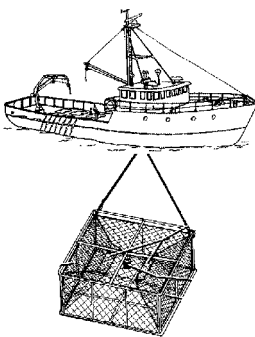

Pot vessels fish with fixed steel or collapsible traps called pots. Fish enter the pot in search of bait, and become trapped inside. Most pot vessels are catcher boats, but there are a few CPs, producing mainly headed-and-gutted product. Pot boats are used to harvest Pacific Cod, Sablefish, and Pacific Halibut.

Longline Vessels

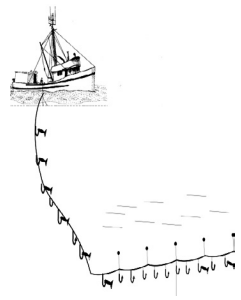

Longline vessels fish with hooks strung along a groundline. The groundline can be several miles long and can have thousands of baited hooks attached. The longline fleet is composed of both catcher boats and CPs. Longliners target Pacific Cod, Pacific Halibut, Sablefish, Greenland Turbot, and some rockfish species.

Trawl Vessels

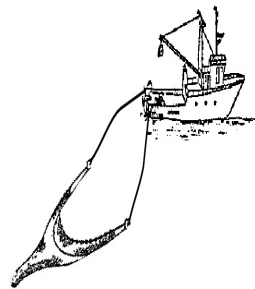

Trawlers fish with a net towed behind the boat. The net is shaped like a large funnel. At the end of this funnel is a bag, called the codend, which collects fish caught by the net. Trawlers make up the largest portion of vessels which carry observers and include both CPs and CVs.

Processing Plants

Processing plants accept fish from CVs, and make preliminary or final products. Catch is transferred from boats to the plant using a large pump. There are two types of processing plants, shoreside and floating. Shoreside processors are on land and floating processors, or "floaters," are anchored vessels which do not fish for themselves, but rather accept deliveries of pumped fish from CVs.

MANAGEMENT PLANS

Management programs have been implemented to allocate quotas among areas, seasons, gear types, vessel types, cooperatives, and even individual fishers. Observer data are used in part for assessing, allocating and monitoring these fish stocks and quotas. This information is used by the Council to write fishery

INTRODUCTION: OTHER MANAGEMENT AGENCIES

management plans (FMPs) for each of the commercially important species it manages. FMPs must comply with standards laid out in the Magnuson-Stevens Act in that they must:

- prevent over fishing,
- achieve optimum yield,
- achieve efficiency and utilization of the resource,
- base management decisions on the best scientific data available,
- manage the fishery throughout its range,
- be fair to all fishers,
- minimize by catch and by catch mortality,
- promote safety of human life at sea.

Time-Area Closures

Time and area closures are used in all ground fish FMPs. These are closures which pertain to specific management areas over specific dates. A time and area closure may be used to protect a different resource, or to stop directed fishing in an area. FMPs call for an annual total allowable catch (TAC) to be set for each species, and parts of the TAC are often allocated to particular management areas or user groups. Once an allocation is reached, the area or a specific group's access to this area closes, while the fishery may remain open in other areas. Once the entire TAC has been harvested, the fishery closes. In open access fisheries, harvested amounts for each statistical area are calculated using mostly observer data.

Area closures can be mandated by other management measures, such as the Marine Mammal Protection Act (MMPA), which closes areas surrounding critical sea lion and walrus habitat at certain times of the year, and the Red King Crab Savings Area (RKCSA), which closes this area to bottom trawling when female Red King crab are gravid. Observer data are used to determine the catch rates for each vessel. Each vessel's bycatch affects the fishery, so those with bycatch rates beyond established limits risk prosecution for exceeding them.



The data you send to NMFS in season are immediately used by the Alaska Regional Office in Juneau for fishery management purposes.

Limited Access Privilege Programs

Limited Access Privilege Programs (LAPPs) are limited access systems whereby permits are issued to individuals or communities to harvest a quantity of fish representing a portion of the TAC. LAPPs can be given to individuals, partnerships, corporations, cooperatives, and fishers' organizations. The Magnuson Act provides specific requirements for implementation of LAPPs. Examples of LAPPs in the North Pacific fisheries are Individual Fishing Quotas (IFQ) and Community Development Quotas (CDQ).

OTHER MANAGEMENT AGENCIES

The FMPs for some species delegate the management to other agencies. The commercial king and tanner crab fisheries are managed by the Alaska Department of Fish and Game (ADF&G), with federal oversight. The ADF&G has a Shellfish Observer Program which collects catch and bycatch data from these fisheries. The fishery for Pacific Halibut is managed by the International Pacific Halibut Commission (IPHC), although the Council has also developed regulations to manage this fishery.

CERTIFICATION AND ENDORSEMENT

To be deployed as an observer in the North Pacific Observer Program, an initial certification and all applicable endorsements must be earned. These certifications and endorsements are earned by the successful attendance and completion of the following training and/or briefings.

Initial Training

A 3-week training is required for all new observer candidates, and for prior observers who have not been deployed in more than 18 months since their most recent debriefing. In some instances, additional training may be required before new observers can work in certain deployment areas, fisheries and gear types.



Trainees must be sponsored by an observer provider. A list of these companies can be found on page A-67.

The 3-week job training is extremely rigorous and intense. This training prepares trainees to successfully collect fishery dependent data according to Observer Program protocols outlined in this manual. Through a variety of lectures, hands on in-class exercises, and

homework, trainees learn the proper techniques of data collection and submission. Most importantly, they learn how to work safely and efficiently under the strenuous conditions encountered in the commercial fishing industry. Observer trainees should expect to spend at least 12 hours a day, including weekends, in the classroom and/or completing assigned material.

Specific requirements for the successful completion of the training course are provided at the start of training. Upon successful completion of the 3-week training, observers receive a certification training endorsement and can be deployed into the majority of fisheries covered by the program.

In order to receive the certification training endorsement, trainees must attend and participate in every training session, complete all assigned homework, and pass all exams. Trainees must also pass a series of safety tests and demonstrate that they know how to respond to an emergency at sea. Additionally, trainees must be able to demonstrate that they can perform a difficult job independently and act professionally in stressful situations.

Briefings

Prior to each subsequent deployment, certified observers must attend a briefing to fulfill additional endorsement requirements. Briefings are designed to provide observers with a review of priorities and duties on different vessel types. Briefing attendance, performance, and conduct standards, as defined by the Observer Program, must be met at the completion of every briefing. All briefings provide an opportunity to ask questions, familiarize yourself with the manual, and review recommendations from your last evaluation. The three most common briefings offered by the Observer Program are:

- **Annual Briefing:** Each certified observer must attend an Annual Briefing prior to their first deployment of each calendar year in order to obtain their annual general endorsement. The duration of this briefing is determined annually and is 2-4 days in duration. This briefing covers changes in sampling protocols, regulations, and any other changes that might impact data collection. Time is allocated for reviewing safety material, enforcement issues, bird identification, and sampling techniques on different vessel types. In some instances, you might be recommended to attend an Annual Briefing to address performance issues, even if you have already completed your Annual Briefing

requirement previously that year. This class is offered throughout the year.

- **Fish and Crab ID Briefing:** Each certified observer must attend a Fish and Crab ID briefing in a 12 month period to remain eligible for deployment. This briefing is offered throughout the year and includes a Fish and Crab ID exam that must be passed with a minimum score of 80%. Successful completion of this briefing is also required to maintain the annual general endorsement. This briefing may also be required before future deployments if you show a deficiency in species identification. This class is offered throughout the year.
- **1-Day Briefing:** Each certified observer who has completed an initial deployment and after the 3-week training or annual briefing, must attend a 1-day briefing to obtain their deployment endorsement for that calendar year. These briefings are designed for observers who have shown no conceptual errors or difficulties in species identification. The 1-day briefing covers recent changes in sampling protocols and regulations, reviews sampling priorities, provides the opportunity for observers to ask vessel and/or fishery specific questions and is the opportunity to refresh written materials pertinent to the upcoming deployment. This class is offered throughout the year.

Additional Trainings and Briefings

In addition to the 3-week initial training and briefing types noted previously, there are other trainings and briefings available to observers to earn additional deployment endorsements or to supplement other class types. Briefing attendance, performance, and conduct standards, as defined by the Observer Program, must be met at the completion of these briefings.

- **Focused Training:** This training is for observers who would benefit from one-on-one tutoring addressing conceptual errors that were identified during their last debriefing. This briefing is tailored to the observer's individual needs and focuses on deficiencies identified in the performance evaluation from the most recent debriefing. This briefing is offered in conjunction with a 1-day or annual briefing on an as needed basis.
- **Safety Refresher Briefing:** This briefing is offered every 3 years in conjunction with that year's Annual Briefing and must be completed prior to the first deployment of that calendar year in order to obtain an annual general

endorsement. This class entails hands-on practice of the safety skills covered in the initial 3-week training. This includes, but is not limited to demonstrating the ability to safely enter the water while wearing an immersion suit, swimming independently and in a group while wearing an immersion suit, boarding a life raft from the water while wearing and immersion suit, and climbing a Jacobs's ladder from the water in an immersion suit.

- **Non-Trawl Lead Level II training:** This training is intended to prepare observers for deployment onto non-trawl vessels that are required by regulation to carry an experienced observer that has earned a non-trawl lead level II endorsement. This 2-day training is available to observers that have earned their trawl lead level II endorsement by completing at least 2 deployments of 10 days or more, successfully sampled at least 100 hauls on a trawl vessel, and have at least 60 data collection days. This training is offered upon request and in coordination with the observer providers.

DEPLOYMENT

Observers are deployed to vessels and processing plants in either the full coverage sector or the partial coverage sector. Your employer will determine the category for your deployment.

The logistical arrangements of your travel, assignments, and debriefing appointments are made by your employer. Often, you will receive your assignment prior to leaving your training location and you may be deployed directly after passing the training class. During one of your last days of training, you will be issued some of the equipment needed to complete your sampling tasks. You are responsible for providing your personal equipment while NMFS will supply your sampling equipment. For additional information regarding your employer's responsibilities regarding your deployment, see "Observer Provider Responsibilities §679.52" on page 20-11.

Personal Equipment

Observers are responsible for providing their own raingear. This is your first and most important protection from wind, spray, inclement weather, and fish slime. Your raingear should be heavy, brightly colored PVC, lined with cotton for strength and warmth. Grundens, Cofish International, Helly-Hansen, and Eriksens are brands

that are frequently used by fisherman and observers. You will need a hooded jacket and "bibs." Dark colors should be avoided since they are difficult to see on deck, especially at night. You will also need several pairs of gloves and glove liners. Fishing supply stores stock a variety of gloves of different weights and materials. You should choose a pair that are heavy enough to withstand harsh conditions, but flexible enough to allow you to write. Waterproof boots should be warm and sturdy, with a non-slip sole. The Xtra-tuff brand is the standard boot for Alaskan fisherman, processors, and observers.

A list of clothes and belongings you may want to bring to sea is provided in Figure 1-2 on page 1-8. If you have questions on what to bring to sea talk to your employer. Generally, first time observers bring too much with them. In one deployment you are likely to be on four airplanes, multiple vessels, and in any number of cabs and hotel rooms. Throughout this you will need to carry both your personal gear and sampling equipment! Rather than taking a lot of clothes, focus on bringing items which can be layered. Working on deck or in the factory of a vessel in Alaska is cold and wet and layering will help protect you from the elements. Synthetic or wool materials are recommended and will keep you warmer than cotton. Inexpensive clothes are also recommended, since the smell of fish is difficult to remove from fabric. While you are at sea, you may store a minimal amount of belongings at NMFS in Seattle. Please note that this service is only for observers while they are at sea, and cannot be used between contracts.

Sampling Equipment

All required sampling and safety equipment is supplied by NMFS. You are required to have access to either a paper or digital observer sampling manual at all times. If you elect to not receive a current paper manual, you must assure you have the most recent digital version. Failure to reference and have access to, the most recent version is not an excuse for noncompliance of observer duties as specified. The equipment you receive may not be new, but it will be in good working order. It is your responsibility to maintain your equipment and return it in the best condition possible. You may be held responsible for misuse or neglect of sampling equipment. It is best to make cleaning and maintaining your equipment part of your everyday routine, since you will rely on this equipment to complete your duties. Some suggestions on how to care for your equipment are:

1. Keep your equipment in a secure place aboard the vessel. Avoid leaving equipment on the vessel's deck. If there is no alternative to leaving it out on deck, be sure that it is well secured. Keep only weather proof equipment on deck!
2. Keep forms, books, pencils, pens, and unused equipment in a dry safe place, such as your room or other secure area. Leave only what you regularly use in the factory.
3. Never leave unsecured equipment on an open deck.
4. Keep all equipment as clean as possible. This will make it much easier for you to clean your equipment when returning it. Use deck hoses to rinse slime, scales, and blood off your baskets, Deck Forms, length boards, clipboards, and knife after each use. Most CPs and shoreside plants have high pressure hoses which are excellent for cleaning equipment.
5. Keep metal parts clean and well oiled. The NMFS-issued lubricant oil is food-grade and can be kept in the factory or out on deck. Do not store wet weighing scales, scalpels, knives, thumb counters, measuring tapes, or other metal objects in plastic bags or containers as this will cause them to rust.
6. If something does happen to your issued equipment, document what happened and notify NMFS staff and your employer. Obtain replacement equipment as soon as possible.
7. Keep your equipment centralized; you will be less likely to forget something when disembarking.



Treat your equipment like the important asset it is! Without it, you cannot complete your duties!

NMFS will issue you safety equipment, including an immersion suit with a strobe light, a Personal Locator Beacon, a life vest with a strobe light and a whistle, a hard hat, ear plugs, eye protection, and a copy of *Beating the Odds: A Guide to Commercial Fishing Safety*. These are provided in order to reduce your reliance on vessel equipment. Keep your immersion suit in a safe, readily accessible location. Both your immersion suit and life vest have zippers on them which need to be waxed regularly to prevent sticking.

The majority of your equipment will be issued to you at your training or briefing location. Additional equipment may be obtained from the NMFS field offices in Dutch Harbor, Kodiak, and Anchorage. Even if you are deployed from these ports, you may be in town for a very short

period of time and it is best to take all the equipment you will need from the NMFS office where you train or brief. If your vessel assignment changes at the last minute, you may need to pick up additional thumb counters, baskets, a Mustang suit or a flatbed scale from the field offices. Let your employer know your needs so they can arrange the logistics with the vessel.

Assignments

Typically observers are deployed for up to 90 days for each cruise. Deployments extending over 90 days must be approved by NMFS. Observers are generally assigned to no more than four vessels and/or plants during a single cruise, and they are usually not deployed on the same vessel for more than 90 days in any 365 day period. With NMFS approval, these conditional limitations may be extended on a case by case basis. Your employer is responsible for the logistics of your deployments and any questions or concerns should be discussed directly with them. Observers may work less than 90 contiguous days because of fishery closures, weather, and erratic vessel schedules.

Observers working in either the full coverage or the partial coverage sectors should have a written understanding of payment and reimbursement agreements prior to leaving, since traveling in Alaska can be unpredictable and expensive. If you need to complete a deployment by a specific date tell your employer's logistics coordinator and get this date written into your contract.

Workload

Working as an observer is a very rewarding opportunity but the workload can be physically and mentally demanding. Many vessels operate 24 hours a day resulting in variable work periods and irregular sleeping schedules. Observers should expect to work about 12 hours a day, 7 days a week throughout their deployment. The 12 hour workday generally consists of approximately 9 hours of data collection activities, and about 3 hours of paperwork and data entry. Work shifts are more consistent when working with multiple observers. When you are the sole observer, your schedule will be less predictable and more variable.

Beginning a New Assignment

Observers are informed of their vessel assignments and all travel logistics directly by their employer. If you are

INTRODUCTION: DEPLOYMENT

This list of items is approximately what you will need for a 90 day deployment. The amount and type of heavy clothing will depend on your personal preferences, the vessel type you are assigned to, and time of year you are working. Items you bring should be old, or inexpensive, since the smell of diesel and fish is difficult to remove. Delicate hand wash items should be avoided. Instead bring items that can be washed together on any washer cycle.

Work Clothes

Raingear - brightly colored bib overalls and jacket with hood (1 set)

Boots- Xtra-Tuff brand highly recommended (1 pair)

Boot insoles- wool or felt insoles made for Xtra-Tuffs (2 pairs)

Gloves- heavy rubber gloves- strong enough for work, but flexible enough to write (6-8 pairs)

Glove liners- polypropylene, wool, or poly/cotton blend (3-5 pairs)

T-shirts- cotton, polypropylene, or light wool (3 shirts)

Sweatshirts- cotton or polypropylene fleece (3- two for work, one for inside)

Pants- cotton or polypropylene sweatpants, or wool work pants (2 pairs)

Shorts- to sleep in (1 pair)

Jeans- a pair of pants for wearing in town (1 pair)

Sandals/Crocs- flip-flops for shower use (1 pair)

Hiking boots- lightweight but waterproof boots for town (1 pair)

Teva/Birkenstock type sandals or Crocs- for wearing inside on the vessel (1 pair)

Long underwear- polypropylene or other thermal (2 pairs)

Socks- wool, polypropylene, or blend (5 pairs)

Neck gaiter- Fleece or smart wool for wearing on deck (2 gaiters)

Ball cap/bandanna- Tie long hair up/keeps slime out of your hair

Hat- wool or polypropylene cap that will fit under a hood (2 hats)

Gloves and hat for town - also fleece ear and neck bands are useful (1 each)

Jacket- any warm jacket for town that will resist rain and heavy winds (1 jacket)

If you are purchasing a jacket to wear at sea, Stormy Seas, Mustang or another brand of float coat is suggested.

Other Items

Personal Survival Kit

Sleeping bag- lightweight, but warm

Pillowcase- some observers carry a flat sheet with them as well

Towel- medium sized terry cloth towel (1-2 towels)

Toiletry articles- these are available in port or in ship stores but are often expensive

Laundry bag- to keep dirty clothes

Seabag- an old or bag (a full length zipper helps). Some observers use Army surplus duffles

Padlock- for your duffel bag, also useful if there is a locker on the vessel

Backpack- suitable as an airline carry-on bag for fragile items and useful as a day-pack in town

Glasses or contacts- bring an extra pair/bring enough pairs of contact lenses to last your entire contract

Cash- some ports do not have an ATMs

Credit card - for purchasing things

Sewing kit- needle, thread, and safety pins. Duct tape is also useful, and common on vessels.

Watch - and /or travel alarm clock

Seasickness medication- Bonine and Dramamine are common brands used by observers

First Aid kit- small, you may want some cold medicine, pain reliever, band aids, etc., and any prescription medications

Vitamins and/or nutritional supplements- especially if you have a restricted diet (i.e., vegetarian)

Books - for reading

Music and headphones- for entertainment

Water bottle - for keeping water near your bunk

Figure 1-2: List of Personal Equipment

deployed in the full coverage sector, you are considered assigned when you arrive at the vessel.

If you are deployed in the partial coverage sector, you are considered assigned to a vessel once you have made contact with the captain and are bound or restricted to that vessel. Your employer will instruct you to contact the captain of your assigned vessel. You may complete the safety checklist, drop off gear, or discuss departure time with vessel personnel, but may not board the vessel until the day of departure. The following scenarios provide further guidance as to what is meant by bound or restricted to the vessel.

- The observer arrives in port on July 1 and contacts the vessel. The captain indicates that the vessel will not leave port until July 3. The observer is considered assigned on July 3.
- The observer arrives in port on July 1 and contacts the vessel. The captain indicates that the weather is looking bad and that the vessel will likely not leave port until July 3. The captain asks the observer to check-in with the vessel every morning to see if the situation has changed. The observer is considered assigned on July 1.

When you begin a new assignment, take time to adjust to your surroundings before the vessel leaves the dock. Present the “Letter of Introduction” to the vessel operator (see page 2-3). Make yourself available to answer any questions the vessel may have. Familiarize yourself with the safety equipment using the Vessel Safety Checklist on page 19-4. You may not remain on board the vessel if you circled “N” for any of the blue “no go” items. Read “Sample Station Requirements” on page 2-32 for information regarding what to look for in a basic sample station. Ask the captain how many hauls are expected each day to determine your sampling schedule.

If you know your first assignment prior to leaving your training location, you may get specific information about the vessel or plant from a NMFS staff member.

Communications

You will be communicating with the Observer Program daily, weekly, or on a trip by trip basis depending on your vessel or shoreside plant assignment. Vessels and plants in the full coverage sector are equipped with ATLAS. This computer software is designed to allow you to enter your data electronically and transmit directly to NMFS. If your vessel or plant has at-sea transmission capabilities, you will be able to send messages to Observer Program

staff via ATLAS. If you are deployed in the partial coverage sector you will be able to send messages via ATLAS each time you are in port and have a wifi signal. Some PC sector vessels have at-sea transmission abilities. Work with the captain to determine if you can transmit at sea. The messages you send via ATLAS are reviewed by Observer Program staff. They will also be able to look at your data and troubleshoot problems while you are still at sea. For more details refer to “Sending Data” on page 2-39.

If you have an illness or injury that prevents you from completing your assigned duties, you must inform NMFS and your contractor immediately. If communications are not readily available on your vessel or if you need immediate assistance, notify your captain. You are expected to provide daily updates to NMFS staff and your contractor regarding the status of your situation. If your condition does not improve and continues to affect your work, your assignment may need to be changed to protect your health and well-being. If you are not able to communicate on a daily basis, keep your captain informed of any changes and contact NMFS and your contractor as soon as you arrive in port.



You must contact NMFS each day an illness or injury prevents you from sampling.

Vessel operators are required by law to allow observers free access to communication systems for work purposes. Their communication systems are not usually for unapproved personal use. Vessel computers and networks are for business use only and should not be used to download or install programs without permission. Any other use, including the use of program approved spreadsheets or documents, must be in compliance with the vessels computer use policy. If they allow you to use the phone or fax for personal use, you may be responsible for the charges incurred.

Mid-cruise and Field Support

The Observer Program has field stations in Anchorage, Dutch Harbor, and Kodiak which provide staff support for observers in the field. When you are in these ports, you should meet with a staff member for a “mid-cruise” debriefing. The mid-cruise allows NMFS staff to review your sampling procedures, calculations and paperwork, and ensure that all is going well. It is an opportunity for you to ask questions and receive suggestions on how to solve any problems you may have encountered.

INTRODUCTION: DEBRIEFING

All observers must complete a mid-cruise during each deployment, until they receive an exemption. Although it is termed a mid-cruise, this debriefing does not necessarily have to take place during the middle of your cruise. It should be completed early enough to allow you to incorporate suggestions and make improvements on your data collection efforts.

When coming into a field station for any reason, calling ahead will help ensure that a staff member will be available to work with you at a specific time. More information on mid-cruises can be found on page 21-7.



In-person mid-cruises can be done in any Observer Program office.

Observer Provider Responsibility

Federal regulations stipulate that observers working in the full coverage sector must have a signed contract with an employer prior to deployment. The contract must contain the provision that each "...observer completes in-person mid-deployment data reviews, unless: (i)... specifically exempted by the Observer Program, or (ii) the observer does not at any time during his or her deployment travel through a location where Observer Program staff are available for an in- person data review". The contract must require that an observer who is not able to complete an in-person review complete a mid-deployment review as described on page 21-8.

DEBRIEFING

When you complete your deployment, you will debrief with an Observer Program staff member. The main components of debriefing are:

- complete a survey for each assignment
- describe the methods used to collect your data
- inform Observer Program staff of problems you encountered
- make corrections or changes to your data
- get recommendations for future cruises
- receive a written performance evaluation
- complete sampling gear check-in

Your debriefing is a vital part of your observer responsibilities because it allows the NMFS to get

feedback from you. It is an opportunity for you to discuss your methods and ask for suggestions if you encountered problems in the field. The debriefing process is your chance to demonstrate your understanding of the methods you learned in training and your proficiency at applying them in the field. At the end of your debriefing you will be given a performance score for each vessel, a written evaluation for your entire cruise, and a briefing recommendation. Your briefing recommendation is the level of training you will need prior to your next cruise to assure you are able to collect high quality data. The recommendation could be for either a 3-day briefing, Fish and Crab ID briefing, 2-day tutorial, 1-day briefing, or 3-week training. For detailed descriptions of these briefings see page 1-5.

The last step in the debriefing process is the exit survey. This is an anonymous questionnaire about your training, deployment, and debriefing experiences. The exit survey allows you to provide feedback to the Observer Program. Your feedback is essential to help program staff identify areas needing improvement and to continue providing observers with the all the tools necessary to successfully do their job.

ESSENTIAL INFORMATION



Table of Contents

| | |
|---|------|
| Responsibilities and Priorities | 2-2 |
| Deployment Responsibilities | 2-2 |
| Data Collection Priorities | 2-2 |
| Managing Your Time | 2-3 |
| Boarding Your Vessel | 2-3 |
| Safety Checklist and Safety Orientation | 2-3 |
| Becoming Familiar with Your Vessel | 2-4 |
| Standards of Observer Behavior | 2-7 |
| Limitations on Conflict of Interest | 2-8 |
| Confidentiality | 2-8 |
| Photos and Videos | 2-9 |
| Consuming Organisms Caught by the Vessel | 2-9 |
| Personal Gain | 2-9 |
| Signing Statements | 2-10 |
| Completing and Organizing Forms | 2-10 |
| Legibility | 2-11 |
| Organization of Data | 2-11 |
| Raw Data Deck Forms | 2-12 |
| Recording Time | 2-12 |
| Species Identification | 2-13 |
| Species Identification Forms | 2-13 |
| Sturgeon | 2-14 |
| Bag and Tag Specimen Collection Label | 2-15 |
| Dropping Off Specimens | 2-15 |
| Transfers of Gear in the Field | 2-16 |
| Observer Logbook Entries | 2-16 |
| Daily Notes Section | 2-17 |
| The Logbook as Evidence | 2-17 |
| Calculations | 2-17 |
| Rounding Rules | 2-18 |
| Selecting Hauls to Sample | 2-18 |
| When to Use the Random Sample Table | 2-18 |
| How to Use the RST | 2-19 |
| Vessel Responsibility and the RST | 2-19 |
| How to Use the RBT | 2-19 |
| If Your Sampling Schedule is Too Rigorous | 2-20 |
| Introduction to Sampling Theory | 2-21 |
| Populations | 2-22 |
| Sample Units and Sample Frame | 2-22 |
| Sampling Steps: The Basics | 2-22 |
| Sample Unit Type for Species Composition | 2-24 |
| Sample Designs for Species Composition | 2-25 |
| Documenting Sample Design Constraints or Problems | 2-26 |
| How to Use the Random Number Table | 2-26 |
| Subset Sampling | 2-27 |
| Subset Sample for Number and Weight | 2-27 |
| Subset Sampling for Species Identification | 2-27 |
| Using Your Scales | 2-28 |
| Taring Your Scales | 2-28 |
| Electronic Scales | 2-29 |

| | |
|--|------|
| Flow Scale Testing | 2-31 |
| Sample Station Requirements | 2-32 |
| Working With Multiple Observers | 2-35 |
| Pre-Offload Meetings with Industry for Bering Sea Pollock Deliveries | 2-37 |
| Inseason Advisors and Inseason Messages | 2-38 |
| Sending Data | 2-39 |
| Non-Fishing Days | 2-39 |
| Sending Data via ATLAS | 2-39 |

INTRODUCTION

You will need to refer to this manual frequently to complete your duties. For many topics, you can refer directly to the chapter that addresses a task or vessel type. Some topics pertain to all observers on all vessel types. *This chapter contains information essential to all observers.*

RESPONSIBILITIES AND PRIORITIES

Deployment Responsibilities

As an observer, you have specific responsibilities that must be met throughout your deployment. These responsibilities are important and all must be met during each deployment. Contact the Observer Program if you are having problems or if you have any questions.

- Safety is always your first responsibility! You must receive a safety orientation and complete your Vessel Safety Check list before the vessel leaves the dock. For instructions on recording safety drills in your logbook see “Emergency Drills and Date(s) Conducted” on page 19-7.
- Monitor for and document compliance infractions and suspected violations in your log book.
- Maintain your logbook. This includes, but is not limited to, recording your sampling techniques, all calculations and formulas, documentation of scale tests, sample area diagrams, and an entry for every day in your Daily Notes.
- Maintain your sampling equipment to ensure your data are collected according to program standards. See “Using Your Scales” on page 2-28 for specific information regarding scales.
- Complete species identification forms.
- Complete your mid-cruise and final debriefing requirements.

- Communicate with your employer on a regular basis. Discuss the details regarding your travel arrangements. Review your employers expectations while you are deployed and while in port between trips. Your employer is responsible for arranging your travel, and housing during your contract period. Review your contract with your employer and ensure you understand the duration of your deployment and how you will be compensated. See “Observer Provider Responsibilities §679.52” on page 20-11 for additional information regarding your provider’s federal regulatory requirements.

Data Collection Priorities

Observer data collection duties are listed below in order of priority. Use this list to remind yourself of the different tasks that need to be accomplished for each haul. Tasks are listed in order of priority from highest to lowest. There will be times when you cannot accomplish all that you should do in a day. Lower priority duties should be reduced first. If you find that you cannot complete all the duties listed, concentrate on those of higher priority. Many of the data collections listed bellow will require you to cut open, and collect specimens from, living organisms. It is not acceptable to forgo required duties to avoid working with live fish.

1. Record takes of marine mammals. Collect snouts and deep tissue samples from all freshly dead pinnipeds (except walrus), and collect deep tissue samples from all dead cetaceans that are in good condition.
2. Record takes of ESA-listed species (Short-tailed Albatross, Spectacled Eiders, and Steller’s Eiders). Collect specimens from ESA-listed species. Rehabilitate injured ESA-Listed species if possible.
3. Record fishing effort and catch information. Make an independent estimate for as many hauls as possible. Record all calculations for your independent catch estimates in your log book.
4. Collect and report salmon data in the pollock fishery

- Salmon Retention Count
 - Salmon Genetics
5. Sample for species composition per protocols in this manual.
 6. Send your data to the Observer Program in Seattle.
 7. Collect additional biological data on prohibited species.
 8. From hauls sampled for species composition, collect otoliths from the appropriate species.
 9. From hauls sampled for species composition, collect sexed length frequency samples from the appropriate species.
 10. From hauls sampled for species composition, record seabird specimen and tag information.
 11. Stomach Collection.
 12. Record sightings of marine mammals.
 13. Complete research projects as assigned.
 14. Record interactions and collect Non-ESA listed seabird species.

Contact the Observer Program if you are having problems or if you have any questions.

Managing Your Time

Your time and effort given to each task should be proportional to its priority. For example, if your vessel catches a killer whale, you should spend as much time as required to gather all the pertinent information and collect a tissue sample, as that is your highest priority. A few suggestions on how to reduce the time and effort you spend on lower priority tasks are:

- Write sightings of seabirds and mammals on your Deck Form. This information can be transcribed onto the appropriate forms during a non-fishing period.
- Collect otoliths and record all necessary data while taking lengths. Avoid measuring a fish twice!
- Write notes regarding potential violations on your Deck Form as you witness them. This information can later be transferred to your log book.
- Prepare paperwork at least daily and maintain your

logbook at the same time. This will allow you to be ready to send your latest information to NMFS when needed.

- If the vessel has ATLAS, send a test message soon after you board to ensure it is functioning properly. Doing this early will save you time later if there are any problems.

BOARDING YOUR VESSEL

Before boarding your vessel ensure the embarkation point is safe, free of obstacles, and that someone is around to watch you. Always wear a PFD when embarking and disembarking a vessel.

Safety Checklist and Safety Orientation

The very first thing you will need to do upon boarding a new vessel is to ensure the US Coast Guard Commercial Fishing Vessel Safety Examination Decal (see page 19-2) is valid and complete the Safety Checklist. *You may not remain on board a vessel that does not have a current decal or has any “no-go” item not in compliance.* If the vessel does not have a current decal or if any “no-go” items are out of compliance, inform the captain that you are not able to remain on board the vessel and immediately inform your employer and NMFS. Document the decal and “no-go” information in your logbook daily notes and the Vessel Safety Checklist.



It is your responsibility to make sure the safety decal and all the blue no-go items are in compliance for the entire time you are deployed on the vessel.

Before leaving the dock you must be given a safety orientation by a qualified crew member. Once the safety orientation is complete, talk to the captain if you have questions or concerns that have not been addressed. Notify your employer, NMFS and document in your logbook any unresolved safety problems.

Vessel Introduction and Operations

Upon boarding the vessel, introducing yourself to the captain should be a priority. Provide the captain with the “Letter of Introduction” and use it as a tool to answer any questions they may have. It’s important at this meeting to set the tone for a friendly but professional working relationship. Remember, while the vessel is in port, the captain is usually busy and may not be receptive at this

time. Do not be discouraged. Ample opportunity should be available to discuss your issues and concerns with the captain while steaming to the fishing grounds.

If the captain is receptive, take this opportunity to mention the following points:

- Tell the captain that it is important for you to routinely see the ship's fishing logs.
- Ask to be informed, in advance, of changes in the fishing schedule so that you may adjust your schedule accordingly.
- Ask to be notified if any marine mammals or short-tailed albatross are found in the catch, regardless of time of day. You should also ask to be notified if any spectacled eiders or Steller's eiders are found anywhere on the vessel or are found inside the catch. Request that all these animals be held for your examination. Ask to be notified, if possible, of marine mammal and short-tailed albatross sightings.
- Ask how you will be notified of haul backs. Devise a plan with the captain and/or mate. Observers are to be notified at least 15 minutes before fish are brought on board. See "Prior Notification" on page 20-13 of the Regulations section for additional information.

If assigned to a catcher vessel, discuss with the captain that you may need notification before the offload begins in order to complete offload duties. (Observers are to be notified at least 15 minutes prior to fish and fish products being transferred from the vessel, e.g. pollock catcher vessel offloads, unless the observer specifically requests not to be notified.)

Vessel Accommodations

Vessels are required to provide observers with accommodations equivalent to those provided for officers or other management level personnel of the vessel.

Becoming Familiar with Your Vessel

As soon as possible, begin adapting to the new surroundings by familiarizing yourself with the layout of the vessel and by meeting the people you will be working with. If the previous observer is available, ask that person to give you a tour of the vessel. Note key areas such as observer quarters, galley, wheel house, factory, and sampling area. If the previous observer is not available,

vessel personnel are frequently assigned to assist new observers with the familiarization process.

Before the vessel leaves port, make sure you have all of your personal items and sampling equipment on board. Check your equipment before leaving port for lost or forgotten items. If the vessel is equipped with ATLAS and the vessel has the ability to transmit from sea, send a test message to ensure it is functioning properly. Contact the field offices if you require additional sampling equipment and forms. If you are prone to sea sickness, get as much critical, pre-sampling work done before leaving port.

A vessel is required to provide observers with a safe work area adjacent to the sample collection site.

It is important that the observer sampling station on board facilitates your objectives and goals. Ask yourself the following questions as you assess the sampling station:

- Is there access to unsorted catch?
- Is the collection site near the sampling station?
- Are there any tripping hazards?
- Is your sample station in a high traffic area?
- Is there adequate room for storing your gear and samples?
- Is there a location where you can secure a hanging scale; if not, do you need a flatbed scale from the field office?
- Is there a work table or a comparable setup available for your use?
- Is there equipment nearby to adequately clean your gear and samples?

If you have the opportunity, you should view the vessel profile prior to deployment in Seattle or Anchorage, or visit one of the field offices.

Pre-cruise meetings

Pre-cruise meetings are opportunities for observers, vessel crew, and NMFS staff to meet prior to the start of fishing operations. Non-pollock trawl catcher processors and motherships and longline catcher processors are required to request a pre-cruise meeting when an observer will be assigned to the vessel for the first time within a twelve month period but any vessel

may voluntarily make a request. Upon receiving these requests, NMFS may elect to conduct a pre-cruise meeting. These meetings help to establish a professional working relationship between the crew and the observer early on in the deployment. NMFS staff can also clarify what is expected of each participant according to regulations. Pre-cruise meetings provide the vessel crew and the observer the opportunity to discuss specific issues and help resolve potential conflicts before they become problems.

Catcher Processor Trawler

Familiarize yourself with life on board and initiate your work with the following:

- If your vessel will be using a flow scale, talk to the captain to determine who will be responsible for testing the scale and how you can obtain haul by haul scale weights.
- Determine the best location for observing the cod end retrieval. Remember that the location needs to be in a place that will ensure your safety and allow a full view of the deck activities. Speak with the deck boss for assistance in determining where the best area is with your objectives and goals in mind. Watch how and where the cod ends are opened and how thick and fast the fish are dumped. Look to see if the crew does any sorting on deck.
- Observe the factory operations. Be aware of all possible hazards. Note where the catch is sorted and what species and sizes are retained. Follow the fish from the deck to the freezer. This is a good opportunity to determine what method would be suitable for obtaining information on the amount of catch that is discarded. Note what products are being made.
- Get started with the most obvious methods for obtaining catch weight estimates, obtaining species composition data and for collecting other biological samples. As time progresses, and you become comfortable with your duties, consider other methods or implement variations in your methods to improve your sampling and data quality.
- If you are assigned to a non-pollock trawl CP or mothership conducting halibut deck sorting review the Deck Safety Plan. Also, review the Halibut Deck Sorting Sample Station Certification Letter and determine what the halibut deck sorting time limit is for the vessel.

- If you are assigned to a CP in the Gulf of Alaska, you may have to make volumetric estimates. Watch the net retrieval and handling. At this time, you can easily decide when and where you will need to take additional measurements. Also, use this time to improve methods for obtaining dimension measurements for codends and bins. Determine whether you require assistance from vessel personnel and enlist their aid.
- When the deck is inactive, perhaps when the vessel is in port or steaming to the fishing grounds, make measurements which will aid you in estimating codend dimensions and bin volumes.

Catcher-Only Trawler

Fishing operations are much simpler aboard a catcher-only vessel but an observer has less opportunity to get oriented as only a few tows may be made each trip.

- When the deck is inactive, typically when the vessel is in port or steaming to the fishing grounds, make measurements which will aid you in estimating codend dimensions or collecting data for bin volume estimates. This would be a good time to measure the trawl alley. Trawl alley measurements may also aid in obtaining codend dimensions.
- Determine the best location for observing the codend retrieval. Remember that the location needs to be in a place that will ensure your safety and allow a full view of the deck activities. Take special note of hazardous or potentially hazardous areas. The captain or crew members may also have some advice on where possible hazardous situations exist.
- Make a note of checker bins or other equipment that will be useful for collecting and storing samples. Space is limited on the smaller vessels so making use of all available resources is a necessity. You may realize at this point that you require an extra basket or two. You can obtain extra baskets from the field offices.
- For the first retrieval, be prepared with sampling equipment ready and in hand. Use this time to observe the retrieval of the net and determine the most appropriate area and method for obtaining a catch estimate, depending on the fishery. Make the effort to measure the codend or collect bin volumetric dimensions of the catch. Watch how and where the codend is opened and how thick and fast the fish are

dumped. Look to see if the crew does any sorting on deck. Observe what is retained and discarded. Observe where and how sorting occurs. By being aware of these situations, you will be able to determine the best method for obtaining discard information and avoiding sample bias.

- During the first retrieval you can decide when and where you may need to take additional deck measurements. Also, use this time to improve methods for obtaining dimension measurements for codends. Depending on the fishery, you may be using the trawl alley as a bin for volumetric estimates. Determine whether you require assistance from vessel personnel and enlist their help.
- If you are required to assist with sampling at a processing plant, you should locate the plant observer before or immediately after your first trip. They can provide an overview on the plant sampling protocol.
- If you are required to monitor your offload and there is not a plant observer, have your sample gear ready upon arrival for offload. Find out where you'll be observing and sorting salmon before your offload begins.

Trawler Operating as a Tender Vessel

If your catcher-only trawl vessel decides to act as a tender vessel (one that receives fish from other catcher vessels and delivers it to a processing plant), your duties will include:

- completing the Trip Form
- recording non-fishing days only on the VHF/OHF form
- recording marine mammal interactions and sightings
- recording bird observations

Longline Vessel

The fishing operations on longline vessels are different from trawl vessels. There are other considerations that should be addressed in the first day(s) of your assignment.

- It is important to be familiar with the units of gear, gear handling, and average number of sets per day. This information will assist you in setting up a routine to complete your duties. Speak with the captain or deck boss to obtain this information. This is also an excellent time to determine the best method of verifying gear,

and number of hooks per segment.

- Sampling for species composition requires an area for observing the gear retrieval and everything that is caught on the gear. Location of this station is dependent on the vessel configuration. This is most likely to be on deck. You will also need to locate an area where you can collect, store, and weigh by catch and target species. This means that you may have more than one sampling station. Remember, working on a longliner imposes many hazards. You need to be aware of all possible dangers and work accordingly.
- During the first gear retrieval, locate an area where you can observe the retrieval of the line and all organisms coming up on the line. You should be near enough to identify most fish to species, family, or to special species groups. Determine what species are retained and discarded both at the roller and in the factory. This is a good time to observe the rollerman and determine what type of control you will have over the collection of by catch. Take into account the retrieval rate of the gear and the amount of gear set in order to conceive a sampling frame. Monitor the quality of gear repairation as this affects overall gear performance.

Pot Vessel

The fishing operations on pot vessels are similar to those on longline vessels with few minor differences.

- It's important to be familiar with the units of gear, gear handling, and average number of hauls per day. This information will assist you in setting up a routine to complete your duties.
- Determine hazardous work areas. Speak with the captain or deck boss to obtain this information. Determine the best method to verify the number of pots set per haul.
- Sampling for species composition can be quite arduous due to the many hazards you need to be aware of as you are working. Pot vessels are small vessels with constant activity. You will need to set up your sampling station away from the gear retrieval area and all of the potential hazards that may occur in that area. Ask the vessel personnel where observers have historically sampled.
- Locate an area where you can observe the retrieval of the pots, yet remain safe of deck activity. Let the deck crew know what your objectives and goals are so

they can work with you. Determine what species are retained and discarded. Take into account the retrieval rate of the gear and the amount of gear set in order to create a sampling frame.

The First Haul

By the time the first haul comes aboard you should have some idea of how you would like to sample. The first catch on board is your first opportunity to test the routine for collecting, sorting, weighing and counting fish that you worked out before fishing began. Determine what methods and techniques you will apply to collect species composition samples. Collect biological data from the predominant species and other species as required. Determine if and what extra assistance will be required to obtain biological data such as sexed length frequencies from the predominant species and halibut assessments. Familiarize yourself with the species caught by using the species identification keys and field guides. Complete species identification forms for all species seen.

Inexperienced observers should be especially careful until they are familiar with the way catch is handled. You may need to reduce your sampling effort for the first few hauls (fewer and/or smaller samples). Document your methods and the reasons for the reduced sampling effort in your Daily Notes. If you are unable to sample a haul for any reason, you must document the circumstances in your logbook. After only a few hauls you will be familiar with the catch handling process and able to decide on a sampling design that is right for that vessel and fishery.

These guidelines are general and are written for observers going to sea for the first time. These guidelines will also assist prior observers who are beginning a cruise on board a vessel, gear type or fishery with which they are not familiar.

STANDARDS OF OBSERVER CONDUCT

As an observer, you are placed in a unique situation of responsibility. The image you present and your integrity in the field affects the views of the industry towards you as an individual and towards the Observer Program in its entirety. The data you collect is critical to the effective management of the marine resources in the North Pacific.

Standards of Observer Behavior

As an observer you must adhere to the following rules:

1. You must perform your assigned duties as described in the Observer Manual or other written instructions from the Observer Program Office.
2. You must accurately record your sampling data, write complete reports, and report accurately any observations of suspected violations of regulations relevant to conservation of marine resources or their environment.
3. You must not disclose collected data and observations made on board the vessel or in the processing facility to any person except the owner or operator of the observed vessel or processing facility, an authorized officer, or NMFS. See “Observer Responsibilities” on 20-10.

Any behavior contrary to these standards, or the intent of these standards, is grounds for decertification. Falsification of data is grounds for decertification and may be a basis for prosecution.

You must follow your employer’s conduct and behavior policy. Your behavior must be in accordance with these standards from the moment you enter a briefing until you have completed your debriefing.

Your behavior when deployed as a North Pacific Observer Program observer not only affects you, but also the observers that follow you in the future and the image of the Observer Program as a whole. It is the expectation of the Observer Program that you will conduct yourself in a professional manner and that you refrain from actions that could negatively affect your image as a professional and/or the image of the Observer Program.

Health Mandates

To assist local communities, the public and industry members, with the prevention and spread of infectious disease, health mandates that outline required actions and/or procedures may be in place at any time during your training, briefing, and deployment. A few examples include restricted access to certain areas, being required to remain on your vessel while in port, not boarding vessels to which you are unassigned, wearing a mask or face covering when interacting with others, and quarantining for a period of time.

Observers must follow all health mandates related to their area of deployment including, but not limited to, mandates communicated to the observer by the observer provider, vessel, shoreside processors and/or the observer program.

Prior to traveling to your port of embarkation, observers should check with their employer regarding any known health mandates associated with the planned deployment.

Working on Vessels and in Processing Facilities

During many of your assignments you will be delivering to and working at shoreside plants, or will be aboard at-sea processors. These are food processing facilities that have strict standards for safety, dress, and hygiene within the factory. Inquire about these rules during your orientation. The vessel or plant will inform you of their specific rules for working in their factory. These rules may include but are not limited to: removal of jewelry, wearing a hair/beard net, wearing a hard hat, prohibiting the use of head phones or not allowing food (gum, beverages, chewing tobacco, etc.) while working in the factory. Observers are required to adhere to all vessel and processor policies while working in processing facilities.

In addition, many assignments will require you to work on the deck of a vessel. While on deck, observers are required to follow all rules and procedures outlined by the vessel, the observer's employer and the observer program. This may include but is not limited to wearing a PFD and hard hat on deck, prohibitions on the use of headphones, and avoiding certain areas of the deck environment.

If there are conflicting guidelines, the observer must follow the most stringent rule. For example, a vessel operator may not require the use of a PFD while on deck, but the observer program does, so a PFD must be worn at all times while on deck.

Limitations on Conflict of Interest

In addition to the standards of conduct, the following limitations on conflict of interest apply to all North Pacific Observer Program observers. Observers:

1. Must not have a direct financial interest, other than the provision of observer services, in a North Pacific fishery, including, but not limited to:
 - any ownership, mortgage holder, or other secured interest in a vessel, shoreside or floating stationary processor facility involved in the catching, taking, harvesting or processing of fish.
 - any business involved with the selling supplies or services to (“...or any business involved with purchasing raw or processed products from...”) any

vessel, shoreside or floating stationary processing facility participating in a North Pacific fishery.

2. May not solicit or accept, directly or indirectly, any gratuity, gift, favor, entertainment, loan, or anything of monetary value from anyone who conducts activities that are regulated by NMFS, or who has interests that may be substantially affected by the performance or non-performance of the observer's official duties.



Note that this standard restricts observers from accepting home-packed fish without purchase.

3. May not serve as observers on any vessel or at any shoreside or floating stationary processing facility owned or operated by a person who previously employed the observer.
4. May not solicit or accept employment as a crew member or an employee of a vessel, shoreside processor, or stationary floating processor in a North Pacific fishery while employed by an observer provider.

Confidentiality

Only the vessel/plant owner or operator, NMFS staff, and you are allowed to see the data you collect. *Never allow crew from one vessel/plant to see any data from another vessel/plant.* Sharing another vessel/plant's data, even inadvertently, can be grounds for decertification. Be particularly discreet when discussing problems, “fishing stories,” or assignments in public places, on other vessels, or through email. You may inadvertently give more information than you mean to. Keep all of your data, including “goldenrod” copies from a vessel logbook, vessel Electronic Logbook printouts, paper forms, deck forms, specimens, fish tickets, photos, and thumb drives, in a safe and secure place for every boat and plant at all times. See page 20-10 for more information regarding observer information.

Providing Data to the Vessel/Plant

You may share your species composition, haul, and biological data with the vessel/plant owner or operator *when it is convenient for you and only at their request.* All the information in your logbook must be kept confidential with the exception of the Vessel Safety Checklist which you may provide the vessel owner or

operator with one of the logbook's black and white copies or make a copy yourself.

It may be easiest to give the vessel/plant owner or operator the data when you are sending it to NMFS. This will allow you to give them completed data on a regular schedule. You are not expected to provide data to the vessel more frequently than your daily data transmission requirements. If the vessel has other expectations regarding the availability of your data, you should inform your inseason adviser and direct the vessel to contact the Observer Program. Providing data to the vessel/plant owner should not interfere with your regular duties.

ADF&G Fish Ticket and Landing Report Information

The information on the ADF&G Fish Ticket and NMFS Landing Report is confidential and cannot be shared with anyone except the delivering vessel's observer. Fax (do not e-mail) fish tickets for vessel observers only to an Observer Program office. Do not fax fish tickets to contractors or to other processing plants!



Vessel/plant owners or operators are often intensely secretive of their operations. They count on you to be discrete when discussing their vessel/plant.

Photos and Videos

Photos and videos are considered observer data. Observers should only take work related photos using a NMFS issued camera. Observers are provided with a NMFS issued camera and are encouraged to use it for any required data collections. Photos and videos provide valuable and supplemental information to a variety of data collection. These data may include but it is not limited to:

- Marine Mammal Interactions
- Species ID Forms
- Fish that are difficult to identify
- Safety deficiencies
- Marine Mammal Sightings

It is important to acknowledge that any photos or videos taken by an observer while assigned to a vessel or plant are the property of the National Marine Fisheries Service as defined by the Magnuson- Stevens Fishery

Conservation and Management Act. You are required to sign a nondisclosure agreement upon completion of every training and briefing. *Personal cameras should not be used to take any photos or videos while on board a vessel or at a processing plant.* The use of a personal camera to take pictures or videos may be considered a violation of this nondisclosure agreement.



All observer information must be kept confidential. Observers must not post observer information on the internet including, but not limited to, social networking sites and other file sharing sites. See page 20-10.

Use of Vessel/Plant Equipment

The vessel/plant is required to allow their assigned observer access to equipment (e.g., computer, phone, radio, fax machine) for official work purposes only (see page 20-12). If you wish access to this equipment for personal use you must seek permission from the vessel/plant operator.

Using the Vessel's Email System

Some vessels may grant you permission to use the onboard email system for personal communication. *The messages you send and receive on these systems are not secure nor confidential!* Communications through vessel email are not private even if you are accessing your own email account! Do not discuss catch, vessel design or any other "shop talk" that could be considered a breach of confidentiality.

Consuming Organisms Caught by the Vessel

Many organisms caught by a vessel during their fishing operations and/or delivered to a shoreside plant, can be retained for personal consumption at the discretion of the vessel/plant operator. Prohibited species, and species that are declared prohibited during the fishing season, that are caught by the vessel and/or delivered to a plant, should not be retained or consumed by anyone on board the vessel or at the plant. This includes prohibited species that are retained under a prohibited species donation program. Observers should never consume an organism caught by the vessel or delivered to a plant, without first obtaining permission from the vessel/plant operator.

Personal Gain

The limitations on conflict of interest and the confidentiality requirements restrict observers from

using specimens or data collected while deployed as a North Pacific Groundfish Observer for personal gain. This includes, but is not limited to, conducting personal research projects, publishing articles, or the sale of jewelry made from fish or fish parts.

Signing Statements

The Vessel Safety Checklist in the observer logbook is the only form that observers are expected to sign. Vessel or processing personnel will occasionally request that observers make written statements, or sign prepared documents or forms regarding observer duties which may include safety issues, validity of their data and compliance issues. *It is critical that you do not sign any document related to your data collection or duties.* You may also be asked to sign documents or forms not related to your data collection or duties which may include safety or compliance issues, housing agreements, or video release forms. Contact your employer and NMFS for advice on how to proceed if this happens. Additionally, written statements should be prepared only for NMFS staff. If vessel personnel want more information, please have them contact the Observer Program Office (see “Contact Addresses and Numbers” on page A-61).

COMPLETING AND ORGANIZING FORMS

During an average day on a vessel, you will fill out at least four different forms. If you are entering your data into ATLAS, you are required to maintain some paper forms; see Figure 21-1 on page 21-3. The following is a list of data form types available with a synopsis of each form’s use:

- **Trip Form:** All vessel observers fill out this form. It captures additional information not provided by the vessel and observer haul forms. The paper version of this form must be completed by all observers, even if they are using ATLAS.
- **Vessel Haul Form:** All vessel observers, whether entering data into ATLAS or faxing it, must complete this paper form. It captures position data at the haul level.
- **Observer Haul Form:** All vessel observers, whether entering data into ATLAS or faxing it, must complete this paper form. It captures haul specific weight data and other haul specific data critical to management.
- **Hook Count and Spacing Form:** Vessel observers faxing their data must complete the paper Hook Count and Spacing Form. It contains the same information as the Deck Form, but must be completed for vessels without ATLAS because the Deck Forms do not fax well.
- **Plant/Vessel Offload Form:** All plant observers and all observers on catcher vessels delivering to a shoreside processor or floating processor must fill out an Offload Form. The paper version of this form must be completed by these observers, even if they are using ATLAS. The Offload Form captures delivery weight information in addition to other data useful to management.
- **Salmon Retention Data:** Raw data is recorded on a Deck Form and is entered directly into ATLAS. There is not a paper version of this form.
 1. Bering Sea: Observers assigned to CP trawlers, motherships, or processing plants, that are targeting or receiving Bering Sea pollock enter Salmon Retention Data into ATLAS.
 2. Gulf of Alaska: Observers assigned to CV trawlers targeting pollock enter Salmon Retention Data into ATLAS.
- **Raw Data Deck Forms:**
 1. **Deck Form:** *The Deck Form is used to capture raw data.* All observers, whether entering data into ATLAS or faxing it, use this form. It is used to capture species composition data, specimen collection data, and all other sample specific information. The only exception to this is halibut deck sort data.
 2. **Halibut Deck Sort Data Form:** This form is used to capture all raw data for halibut deck sort species composition samples and viability assessments. Only observers on non-pollock trawl catcher processors and mothership that are conducting halibut deck sorting use this form.
- **Species Composition Form:** Only vessel observers faxing their data must complete the paper Species Composition Form. It contains the same information as the Deck Form, but must be completed for vessels without ATLAS because the Deck Forms do not fax well.

- **Length and Specimen Form:** Only vessel observers faxing their data must complete the paper Length and Specimen Form. It contains the same information as the Deck Form, but must be completed for vessels without ATLAS because the Deck Forms do not fax well.
- **Marine Mammal Interaction and Specimen Form:** Only vessel observers faxing their data must complete the Marine Mammal Interaction and Specimen Form. This form captures single event information for marine mammal interactions and specimens. Observers on ATLAS vessels enter mammal interaction and specimen data and send it electronically.
- **Bird Interaction, Activity, And Species Form:** Only vessel observers faxing their data must complete the Bird Interaction, Activity, and Species Form. Observers on ATLAS equipped vessels enter bird data into ATLAS; however interactions with Short-tailed Albatross must be entered into ATLAS and recorded on the paper forms.
- **Bird Specimen and Tag Information Form:** Only vessel observers faxing their data must complete the Bird Specimen and Tag Information Form. Observers on ATLAS equipped vessels enter bird data into ATLAS; however interactions with Short-tailed Albatross must be entered into ATLAS and recorded on the paper forms (both the Bird Interaction and Specimen Form and the Bird Specimen and Tag Information Form).
- **Marine Mammal Sighting Form:** All observers complete Marine Mammal Sighting Forms. These forms capture information regarding the species seen (if known), behavior of the mammal, and location sighted. The form is turned in at debriefing. These data are not entered into ATLAS and the form is not faxed.
- **Species Identification Form:** All observers must fill out Species Identification Forms for each new species they see. The form captures characteristics of the fish in-hand and is used to verify observers' species identification skills.

Specific directions on how to fill out each form can be found in the following chapters. Always have your manual with you when you are filling out paperwork. Refer to the instructions for the form type you are working with when filling out that form. This will save you time by allowing you to complete the form correctly and completely the first time, rather than returning to

it much later to fix errors or complete entries that were missed.

Legibility

Your data and logbook entries must be clear and legible. If your writing is unclear, incorrect data may be entered into the inseason database used to manage the fishery. During debriefing, these errors need to be fixed, and if the debriefer is unsure of a number, he or she will need to have you present to interpret your data. This will lengthen time spent debriefing, and if questions cannot be resolved data may be lost.

To ensure that your data are legible:

- Write carefully in clear, dark writing.
- Do not erase any raw data on the Deck Forms.
- Record the data in an organized manner.



Pay particular attention to your hand writing when preparing paper forms for faxing. Faxing degrades the legibility. Illegible data cannot be entered into the inseason database!

Cruise Numbers

The Observer Program refers to the time between training and debriefing as a “cruise”. A unique numerical cruise number is used as the identifier of the data you collect during this time. Your cruise number will remain the same throughout your cruise and will be provided at the end of your training or briefing.

Organization of Data

Keep a separate set of data for each vessel or plant assignment. Fill in the header information on every page of every form type for every assignment. If the header information changes, then a new form must be started. *If trip or haul data on the form straddles the end of one year and the beginning of the next, a new form should be used to capture all the data for that haul or trip.*

Observers using ATLAS need to keep data backed up and/or archived on their observer issued flash drive for each vessel or plant. These flash drives should be kept with the paper forms and they should be brought to the mid-cruise and final debriefing. *Individuals on assignments with ATLAS must also keep paper copies of specific forms; see “Forms Required by Assignment” on page 21-3.*

Page Numbering

Data forms are numbered separately by form type. One exception is Halibut Deck Sort Data Forms which are grouped and numbered with all other Deck Forms for each vessel. Page numbers must be entered at the top of each form type in the “page_ of_” fields. Put the number of the page in the first blank as you complete the forms at sea. At the end of your deployment, put the total number of pages in the second space. For example, “Page 3 of 40,” indicates that this is the third page of forty for this form type.

Vessel Haul Forms and Observer Haul Forms

Haul Forms and Observer Haul Forms are two different form types, so they must be numbered separately. To keep these forms orderly, you must have one Vessel Haul Form for each Observer Haul Form and you must be consistent with haul documentation between forms. For example, if you record hauls 1-9 on page number 1 of your Vessel Haul Form, record only these haul numbers on page number 1 of your Observer Haul Form even if more space is available.

Raw Data Deck Forms

Raw data collected on deck or in the factory are recorded on waterproof Deck Forms or Halibut Deck Sort Data Forms. Halibut Deck Sort Data Forms are issued to observers deployed on non-pollock trawl catcher processors or motherships that will be conducting halibut deck sorting and are used to record halibut deck sort data. Observers deployed on non-pollock trawl catcher processors or motherships that will be conducting halibut deck sorting will be issued Halibut Deck Sort Data Forms that are used to record halibut deck sort data. *Do not erase any raw data on your Deck Forms or Halibut Deck Sort Data Forms.* If a correction needs to be made, cross it out and write the correct value next to it. Erasing raw data can be grounds for deleting the data.



Deck Forms and Halibut Deck Sort Data Forms must be used to record raw data. All of your original raw data must be submitted at debriefing.

Following these tips will help you organize your data on the Deck Form or Halibut Deck Sort Data Form.

- All data entered into ATLAS or transcribed onto paper forms must be entered line by line to match the raw data recorded on the Deck Form or Halibut Deck Sort Data

Form. There is one exception to this rule. When you enter salmon and crab species that have an associated sex, sum the lines of data on your Deck Form to enter these as a single line of data by sex into ATLAS or the paper form (see Figure 18-27 on page 18-13).

- All header information must be completed. *This includes blank forms that may be used for additional information.*
- Use the open space on the Deck Form to record bin measurements, codend measurements, trawl alley heights, hook counts, specimen collection notes, marine mammal and seabird notes, etc.
- Write as large as needed to be able to read your data.
- Rinse the forms often while you are sampling. If you write on top of scales and blood your writing will rinse away with them!
- Write as dark as possible with a pencil. With rinsing, your writing will fade.

When there are two or more observers on a boat, *each must write their initials on the Deck Forms and/or Halibut Deck Sort Data Forms for samples they collect. When entering composition data into ATLAS, enter the cruise number of the observer who collected the sample in the “sampled by” field.*



Do not enter “place-holder” data in ATLAS in an effort to allow lower tiered data to be entered. If the completion of your forms and data entry is being significantly delayed by the vessel not reporting data in a timely manner, document the circumstances and contact your inseason advisor. For more information about a vessel’s Record Keeping and Reporting requirements see page 20-13.

Recording Time

Record time on your forms using Alaska Local Time (ALT), which observes the time in the Alaska Time Zone. Here are some additional guidelines to follow when recording time:

- The western Aleutian Islands are in the Hawaii-Aleutian Time Zone. *Regardless of where your vessel is in Alaska, continue using Alaska Local Time.*
- Use the 24-hour clock (0000-2359) to record time and do not include colons. Most digital watches can be set to a 24-hour clock. This makes tracking and recording

time easier.



The Alaska Time Zone also follows the same Daylight Saving Time (DST) schedule as the rest of the United States. Make sure you follow this as well when recording time.

SPECIES IDENTIFICATION

Observers should only identify organisms to the level provided in the Rockfish Guide and Species Identification Manual issued by NMFS. Only those species or families identified in the observer ID guide should be reported by the observer in the species composition data. Those organisms that require a verification specimen are noted in the manual via an asterisk. Observers should bring back specimens for which the ID is questionable, along with specimens found outside of their known geographic range. Identification of unusual or rare species or families not found in the dichotomous keys provided will not be accepted without a specimen. Use only those species codes listed in the appendix on A-3.

Example: You may know from experience that the fish in front of you is a Kelp Greenling. The ID Manual identifies this to the level of greenling, so you will record “Greenling” on the Deck Form and enter “code 390 - Greenling unidentified” into the Species Composition Form (paper or ATLAS).

Species Identification Forms

Species ID Forms are used to verify that species seen during a deployment were correctly identified. ***Complete, detailed, and correct species identification forms are required for all fish, crab, and dead seabird species that are new to you.*** Each time you encounter an ESA-listed seabird species, an unidentified fish or seabird, you are required to complete a Species ID form. First time observers are required to complete Species ID Forms for the first sighting of all fish, crab and dead seabird species. Prior observers need to complete ID Forms for species that have not had an acceptable form in the past, and continue to complete ID forms for any other species they have not seen before. Prior observers who demonstrate deficiencies with species identification may be required to complete ID forms for each species seen during their next deployment. The rules for filling out these forms are:

- Only forms successfully completed while deployed as a NPOP observer will apply to your future Alaska

deployments.

- Species ID Forms ***must be filled out with the fish in-hand!***
- Species ID Forms must be complete and detailed. Incomplete ID Forms (e.g., length or weight missing, lack of defining characteristics, no drawing) will not be accepted and will have to be redone.
- Each species ID form must include a drawing illustrating the characteristics that are referenced in the ID guide to identify the organism. Drawings may be done on the ID form or on a separate Deck Form if needed. Photos taken with the NMFS issued camera should accompany each ID form when possible. ***Forms that do not have an associated drawing will not be accepted.***
- Gill raker counts can differ from the eyed side to the blind side in flatfish. Always count gill rakers on both sides and identify the flatfish according to the higher count (e.g., a rock sole in hand has 6 gill rakers on the lower part of the first arch on the eyed side. On the blind side it has 7 gill rakers. It is identified as a Northern Rock Sole because it has 7 gill rakers on the blindside).
- Head spine counts can differ from side to side in rockfish. Always check both sides and record the higher number of head spines present on the ID Form
- Use your NMFS issued camera to take photos of as many fish specimens as possible. These photos can be submitted with your Species ID Form. The photo must be an image of the same individual that is described on your form for it to be accepted. Include the ID Form in one of the fish photos so that the species name, haul and sample numbers are visible. If you record species ID data on a Deck Form and transcribe the information to a Species ID Form, the form with the original raw data must be submitted along with the Species ID Form. ***The Species ID Form will not be accepted without the original raw data.***
- Sharks must be identified to species using the Family Key in the Species ID Manual.
- Species ID Forms must describe in detail what you observed from your specimen. ***Do not copy information from the key.***

ESSENTIAL INFORMATION : COMPLETING AND ORGANIZING FORMS

- Complete a Seabird Species Identification Form for all dead non-endangered seabird species encountered for the first time.
- Species ID Forms are not needed for invertebrates other than crab species.

During debriefing, you may be asked to provide a verbal description of a fish. If you are not able to provide an accurate description of a species recorded in your samples, NMFS may require you to attend a Fish and Crab ID Briefing and pass a fish/crab ID test. It is advisable that you complete ID forms on rarely encountered species, so that your debriefer may review it during your debriefing interview.

Failure to complete Species ID Forms is considered not meeting the expectations of the Observer Program and will be reflected in your final evaluation.

| | | | |
|---|-------------------|----------------------------|--|
| Vessel name: <u>Fishin' Impossible</u> | | Vessel permit: <u>5123</u> | |
| Species common name: <u>Mystery fish #5</u> | | | |
| Observer: <u>John Doe</u> | | Cruise: <u>8800</u> | |
| Haul #: <u>164</u> | Photo: <u>Yes</u> | Fork length: <u>40 cm</u> | |
| Specimen collected?: <u>Yes</u> | | Weight: <u>0.6 kg</u> | |

FISHES:

How many dorsal fins does the fish have? ① 2 3

Is an adipose fin present? YES NO

Pelvic fins? Present very small Absent

Pelvic fin position: abdominal thoracic jugular

Describe the caudal peduncle (if present) and caudal fin shape:
Short caudal peduncle w/ medium sized fin.
Caudal fin is truncate.

Describe the lateral line(s) if present:
Several lateral lines present - (4 counted)

Draw the fish here:

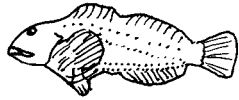

Field characteristics important in recognizing this species:
Long dorsal fin with a slight notch posterior of pectoral fin.

Figure 2-1: Example of Species ID Form for an Unidentified Fish

WANTED! Fish

Please refer to the WANTED! poster included in your Species ID Guide for the list of species that

when encountered, a whole specimen is required for confirmation.

Sturgeon

If you encounter a Sturgeon, you are asked to collect additional biological data. For data collection guidelines, see “Sturgeon” on page 13-15.

Collection of whole fish, crab, and invertebrates

Whole fish, crab, and invertebrates are collected for various reasons such as, but not limited to, verification of species identification, range extensions, and fish collections for training. These specimen data are entered into ATLAS with a barcode.

Bagging and Tagging the Organism

Follow these steps when collecting specimens:

- Rinse the specimen to remove any extra scales, blood, and slime.
- Place the specimen in a plastic bag, making sure it lays flat, along with a completed Bag and Tag Specimen Label. Ensure the information on the label can be viewed through the bag. Each plastic bag should only contain one organism in order to prevent the individuals from freezing together and damaging the collection.
- Place a barcode sticker onto the waterproof label. This barcode number will be recorded on the Bag and Tag Specimen Collection Label.

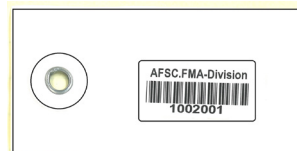

Figure 2-2: Barcode Label with Barcode Sticker for Whole Fish, Crab, and Invertebrate Collections

- Affix the waterproof label with barcode sticker to the plastic bag using a zip tie
- Complete the Fish/Crab/Invert. Tracking Form in Atlas. For instructions on completing this form see page 18-22.
- Freeze the organism and return it to a NMFS field office.
- Always check with the captain/plant manager for

the best place to store your specimens. If additional wrapping is needed to avoid contamination with food products be as accommodating as possible.

- Notify your inseason advisor any time you collect a whole fish, crab, or invertebrate, seabird, or marine mammal specimen to bring back to NMFS.
- Bring specimens to a NMFS office as soon as possible.



Barcodes are ONLY used for whole fish, crab, and inverts. They are NEVER used for They are NEVER used for bird or mammal specimen collections.

Dropping Off Specimens

The specimens you collect are very important and care must be taken to ensure they are stored and transported to a NMFS office properly. Follow these protocols to store and transport your specimens:

- Keep specimens frozen or salted (salmon snouts and skate vertebrae)!
- Utilize your inseason advisor and/or observer provider to notify the field office of your pending arrival to drop off specimens.
- Record all specimens dropped off at a field office in the “Specimen Collection Effort” page in your logbook.

Frequently Asked Questions

- **Q:** What do I do if the field office is not open when I am in port?
- **A:** Find a place to store the specimens until the field office is open. Freezer space may be available on your vessel or in your bunk house. Contact your provider and inform them of your need to drop off your specimens. Once the field office is open follow the steps outlined above.
- **Q:** What do I do if I disembark in a port without a field office?
- **A:** Do your best to keep your specimens frozen. You can wrap them in paper or other insulating material to slow the thawing process. Once you arrive in a port with a NMFS office follow the steps outlined above.
- **Q:** What if I have to board another vessel immediately?

- **A:** Be sure you have informed your provider that you have specimens needing to be dropped off from your previous assignment. Visit the field office and follow the steps outlined above at the next available opportunity.

Bag and Tag Specimen Collection Label Instructions

The Bag and Tag Specimen Collection Label is designed to ensure sufficient information is provided with specimens that are collected, frozen, and returned to NMFS offices and to label salmon snouts. Follow these instructions when completing the label.

Cruise: Record the cruise number of the lead or sole observer.

Permit: Record the permit number for the vessel or processor you are deployed to.

Trip: If the specimen is not associated with a specific haul or offload record the trip number.

Haul: Record the haul number from which the specimen was collected.

Offload: If the specimen was collected during an offload, record the offload number.

Sample number and sub-sample number: Record the sub-sample number and/or the sample number if the specimen was collected from within a species composition sample.

Cruise No. If not collected by lead: If the specimen was not collected by the lead observer, record the cruise number of the observer that collected the specimen.

Location information for trip level collections: If the specimen was collected at the trip level, record the best location information (latitude/longitude or port) available to you.

Species Code: Record the appropriate species code for the specimen. Complete lists of fish and invertebrates, seabird, and marine mammal species codes may be found in the Appendix

Species Name: Record the appropriate species name for the specimen.

Reason for Collection: Fill in the most appropriate bubble that describes the reason you are collecting the

ESSENTIAL INFORMATION : TRANSFERS OF GEAR IN THE FIELD

specimen. If none of the reasons apply, select Other and describe the reason in the Comments section of the label.

Comments: Record any other pertinent information in the comments section.

Specimen No. or Barcode: Record barcode number for whole fish, crab, and invertebrates. Record the specimen number if you are collecting a salmon snout, vertebrae specimen, mammal specimen, or bird specimen, that will be entered in the Length Data Form in ATLAS.

| Bag and Tag Specimen Collection Label | | | | | | |
|--|------------------------------------|--------------------------------------|--|-----------------------------------|----------------------------------|--|
| Cruise | Permit | *Trip No. | Haul No. | Offload No. | Sample No. | S-Smpl No. |
| 20002 | 1210 | | 4 | | 2 | |
| Cruise No. If not collected by lead: 20004 | | | *location information for trip level collections | | | |
| Species Code: 525 | | Species Name: Lump sucker | | | | |
| Reason for Collection | | | | | | |
| ID Verif. <input checked="" type="radio"/> | Out of Range <input type="radio"/> | Training Spec. <input type="radio"/> | Salmon Snout <input type="radio"/> | Mammal Part <input type="radio"/> | Bird Spec. <input type="radio"/> | Other Describe in Comments <input type="radio"/> |
| Comments: | | | | | | Specimen No. or Barcode 1002001 |

Ver. 2024

Figure 2-3: Example of Bag and Tag Specimen Collection Label for Whole Fish Collection

TRANSFERS OF GEAR IN THE FIELD

You are responsible for the gear that is issued to you. Lost gear may need to be replaced by you or your employer. During the course of a deployment you may need to pick up or drop off gear at a field office. Rarely, you may also need to exchange gear with another observer to meet your sampling needs. To ensure your gear is accounted for, all exchanges, pick-ups or drop-offs of gear must be documented in the “Changes to Gear During Deployment” section of your logbook. *It is never acceptable to leave your gear at a field office or other location without first contacting NMFS staff for directions.*

OBSERVER LOGBOOK

Your logbook is probably the single most important piece of data because it contains additional information about all other data. Observers deployed in the full coverage sector will receive one Observer Logbook for each cruise. This logbook is used through the entire deployment.

Observers deployed in the partial coverage sector will receive one Observer Cruise Logbook and 10 Observer Trip Logbooks. The Cruise Logbook is retained through the entire deployment. The Observer Trip Logbooks are used for individual vessels and mailed to NMFS with the vessel data as instructed by program staff. See “Recording Time” on page 2-12 for more information about mailing data.

Observer Logbook Entries

Your logbook captures needed information about your assignments, factory/deck and plant diagrams, calculations, sampling designs, and notes regarding your sampling activities. You also record information about your sampling gear and specimen collections in your logbook.

Have your logbook with you whenever completing paperwork so you can easily record your calculations, make notes regarding your data collection, complete scale verification records, and document potential regulation issues.

Many observers make notes on their Deck Forms to remind them of particular events that happened while they were out on deck or in the factory. This is an excellent idea, **but is only effective if the details of the events are filled in as soon as possible in the logbook.** Remember, events which seem ordinary to you on this vessel may be unusual to the fleet or fishery, so don’t hesitate to write down any information which affects your work or day-to-day life aboard the vessel.

Your logbook is your field biology notebook and must be treated as such. **Do not use it as a personal journal.** You should refrain from venting frustrations or making slanderous, derogatory or discriminatory remarks in your logbook. Keep your tone professional, objective, and respectful. You must document any interference or inappropriate behavior towards you, however it is not necessary to include superfluous and/or gratuitous comments in order to convey how this behavior affected you. Additional guidelines on documenting harassment and other type of violations can be found in “Victim Crime Violations”, 20-3 and “Guide to Documentation” on page 20-5.

Your logbook must be kept confidential while you are on the vessel. During debriefing, you will submit your logbook with the rest of your data to NMFS.



The Vessel Safety Checklist is the only part of your logbook that may be photocopied or have a copy of it torn out and given to the vessel. Originals of the checklist must remain intact in your logbook.

Daily Notes Section

Use the Daily Notes section to document on problems that occurred while you were aboard the vessel, any illnesses or injuries you suffered, your methods for catch estimates, the reasons you chose all sampling methods, and any circumstances that affected your sampling duties or caused you to change your sampling design. The complete details of your sampling methods should also be recorded in the “Sample Design Detail” section of your logbook. Record the circumstances surrounding any violation you witness, including harassment, mishandling of prohibited species, interference with your duties, harassing or harming marine mammals, and MARPOL (marine pollution) violations.



Set aside time every day to write in the Daily Notes section.

Make an entry for every day and describe the day’s events, even if it was what you would consider an “ordinary day.” The more self-explanatory your documentation is, the better. Logbooks may be referred to months or even years after your cruise is complete. Therefore, good documentation is vital to what the NMFS considers “meeting expectations” for a successful cruise.

The Logbook as Evidence

Your logbook is archived and used as a reference to provide more information about your data. It may also be used as evidence if regulatory infractions occurred. Therefore, your calculations may be recorded in pencil, but all other entries must be in ink. If you need to make a correction, draw a single line through the incorrect word(s) and continue with the correct wording. Do not completely cross-out anything, use correction fluid, or tear out pages or parts of pages! If you obscure any part of an original entry, you leave the reader wondering what was originally there. This may affect the validity of your logbook and data (see Figure 2-4).

02/24 continued
 So, I asked the factory ~~foreman~~ manager, John Baker, if this was always the case. He said that sorting the halibut like this was very ~~usual~~ unusual but that they did do this if the halibut catch was too large (lots of halibut in the haul) or if they had one or two very large halibut. I told him that ~~I thought there were~~ I didn't notice a lot more halibut than in previous hauls and explained to him that this was presorting and shouldn't happen if I was to

Figure 2-4: Properly Corrected Logbook Entries

CALCULATIONS

All calculations, must be documented. More involved calculations such as densities and observer estimates must be recorded in your logbook. If you make any total delivery weight adjustments, you can record these directly on the fish ticket or your logbook. Document all your calculations, and the formulas used in order to make your data self-explanatory. All components of a calculation should be recorded and clearly labeled so that another person will easily understand and follow it. Be consistent with the format and location of calculations to ensure they are easy to read and edit.

Calculations may be in pencil, but all other logbook entries must be made in ink!

Even calculations which you may think are trivial or obvious must be documented. This includes, but is not limited to, conversions from pounds to kilograms, length to weight conversions, and the differences between start and end weights when using a flow scale for haul weight or sample weight. These calculations may be recorded on your Deck Forms. Calculations on Deck Forms are considered raw data and should not be erased. For example: you weigh a basket of pollock and record the weight on the deck sheet. When you proceed to count the pollock, you encounter a jellyfish in the basket. Once you weigh the jellyfish, you subtract its weight from the initial basket weight to obtain the pollock weight. Record this calculation: pollock basket - jellyfish in basket = actual pollock weight in basket. Failing to follow these guidelines may result in data loss.



In your calculations, you must use 3.1416 as the value for pi and 0.4536 for the conversion of pounds to kilograms.

Rounding Rules

When you are performing a calculation, carry the numbers out full field until you have reached your final product. *Do not round any numbers within the calculation!* Calculations that require you to follow these rounding rules include but are not limited to codend estimates, densities, vessel estimate conversions, and decimal minute conversions. For example, values used for height and width in volumetric equations are typically the average of three or more separate values. It is a common mistake to use rounded average height and width measurements in volumetric equations. Rounding within a calculation will cost you time in debriefing!

When you round a final product to enter on a paper form or in ATLAS, round to the number of decimal places required by the column. To round your final product:

- look *only at the first digit* to the right of the number you are rounding,
- if $X \geq 5$ round up, if $X < 5$ round down.

For example, when recording your final density on the Observer Haul Form, you need to round to two decimal places. If your final calculation was 927.8286532 kg/m³, you would round up to 927.83 kg/m³. If your final calculation was 972.8226427 kg/m³ you would round down to 972.82kg/m³.

SELECTING HAULS TO SAMPLE

Deciding which hauls to sample depends on a variety of things. You must consider the fishery the boat is participating in, gear type, vessel type, the time and energy necessary to complete your observer duties, and most importantly, your health and safety. In general, we want you to sample “as much as possible,” but in a safe and reasonable manner. *Please reference the trawl, longline, and pot sections of the manual for further details and guidelines for selecting hauls to sample for the different gear types.*

When All Hauls Should be Sampled

All hauls should be sampled if there are two or more observers aboard the vessel. Observers aboard catcher-only trawlers participating in the pollock fishery are expected to sample every haul. These vessels make relatively few hauls each day, so sampling all hauls is possible. In general, observers aboard vessels

participating in other fisheries can sample all hauls if the vessel is taking three or fewer hauls per day or if the vessel only fishes for part of the day. Catcher/processor longline vessels with one observer are the exception to this generality, and observers may need to use the RST or RBT on a longline CP retrieving more than two sets a day.

When All Hauls Cannot Be Sampled

If you cannot sample all the hauls, you must take numerous steps to ensure that their samples are as random as possible. This allows the Observer Program to stand behind your data, and makes it legally and scientifically defensible. The first step is to randomize which hauls you will sample for species composition. There are three methods for randomly selecting hauls to sample:

- Use the Random Sample Table (RST).
- Use the Random Break Table (RBT).
- Use the RST with the RBT when needed.

If your sampling effort is low and/or you are having difficulty deciding how to randomly select hauls to sample, contact NMFS staff for assistance (see “Contact Addresses and Numbers” on page A-61) and document the problems in your observer logbook.

There could be many reasons that preclude you from sampling a haul as required such as severe weather conditions that could impact the crew or your safety. Keep in mind that, although you may not be able to collect composition data, it may be possible for you to verify haul data on hauls not being sampled. This may be of particular importance on vessels that are not required to maintain a logbook.

When to Use the Random Sample Table

If you are not able to sample all of the hauls that your vessel brings aboard on a normal day, use the RST to determine which hauls to sample. Use of the RST is not permitted on pollock catcher vessels or when working with two observers. If you feel that you will usually be able to keep up with all the hauls, but may need an occasional break if fishing picks up or you fall behind on other duties, the RBT may be a better choice. A discussion on when and how to use each of these tables follows.

Versions of the Random Sample Table (RST)

There are four versions of the RST. The difference between the tables is the number of “off” hauls in each sequence. Hauls which are not to be sampled are referred to as “off,” and hauls which are to be sampled are referred to as “on.” The four versions of the RST are:

1. C/P (Longline) landing 3 or less hauls/day RST.
2. C/P (Trawl & Longline) landing 6 or more hauls/day RST.
3. C/P (Trawl & Longline) landing less than 6 hauls/day RST.
4. Catcher Vessel (Trawl & Longline) RST

The catcher vessel table has one “off” haul in each sample sequence, while CP tables can have between one and three off hauls in each sequence. *Choose an RST which is appropriate and will best fit your needs.*

You may choose to use a more rigorous schedule, but you may not use a less stringent schedule than your vessel type and fishing activity requires.



Use the RST which is most appropriate to your vessel. You may always use a more stringent table if you can keep up with it!

Look at the title of the table to be sure you are using the correct one. When you first board a vessel, ask the captain how many hauls he expects to land each day. Use this number to determine which table to use. Once you choose an RST, you should stick to it, unless the vessel changes fisheries, or drastically changes their fishing habits.

| | A | B | C | D | E | F | G | H | I | J | K | L | M |
|---|---|---|---|---|---|---|---|---|---|---|---|---|---|
| A | 2 | 3 | 2 | 4 | 4 | 2 | 3 | 2 | 4 | 3 | 4 | 2 | 4 |
| | 1 | 1 | 1 | 1 | 1 | 1 | 1 | 1 | 1 | 1 | 1 | 1 | 1 |
| B | 4 | 3 | 4 | 4 | 3 | 2 | 3 | 2 | 3 | 3 | 2 | 3 | 2 |
| | 1 | 1 | 1 | 1 | 1 | 1 | 1 | 1 | 1 | 1 | 1 | 1 | 1 |
| C | 2 | 4 | 3 | 3 | 3 | 3 | 3 | 3 | 3 | 2 | 4 | 3 | 3 |
| | 1 | 1 | 1 | 1 | 1 | 1 | 1 | 1 | 1 | 1 | 1 | 1 | 1 |

Figure 2-5: Random Sample Table (example)

How to Use the RST

In the RST, the bold-face rows of type indicate the number of consecutive “on” hauls that should be sampled. The normal-face type rows are the number of consecutive “off” hauls that are not sampled. You will be instructed how to enter the RST during your training or briefing. From this point move vertically down through the table sampling or not sampling the number of hauls as indicated. If you reach the bottom of a column begin again at the top of the next column. If you reach the end of the table (Z, Z) continue at the top of the table (A, A).

Vessel Responsibility and the RST

The RST was designed to randomize the hauls sampled by an observer. It is the vessel personnel’s responsibility under CFR 679.50(f) to “notify observers at least 15 minutes before fish are brought on board, to allow sampling the catch, unless the observers specifically request not to be notified.” If vessel personnel are not notifying you of retrievals, it can affect your ability to sample according to instructions. Talk to the captain to ensure he understands that you must be notified of fish coming aboard. If problems with notification continue, be sure to document this in your logbook and inform NMFS staff through ATLAS or when you are in port.



Do not give your RST to vessel personnel. Inform them verbally only when you wish not to be notified!

The RST is for your use only. Your samples are meant to represent the catch under normal fishing activities. If the crew knows which hauls will or will not be sampled, they could alter their fishing activities. In order to avoid this possible bias, do not give your RST to vessel personnel. If you need to let the captain know your immediate schedule in order to get some uninterrupted rest, do this verbally.

How to Use the RBT

Random break tables are designed to give observers a six-hour break each day when normal vessel operations do not permit adequate time off. The RBT is another tool that can be used to randomize which hauls are sampled. The RBT can be used alone, when an RST provides too much time off, or in combination with a RST on any vessel type when all hauls cannot be sampled. Remember, the RBT should only be used if you cannot sample all the hauls. If your vessel does not fish for part of a day, or makes

one long tow (usually at night), you should consider that your break and disregard the random break table.



The RBT can be used alone, or with the RST to randomize sampled hauls and time off. Consult NMFS staff if you frequently use the RST and RBT together as your sampling effort for that vessel will be low.

Unlike the RST, you can use the random break table on some days, and not on others. Of course, you may also use it every day. Once it is used, you must track each day on the RBT, whether the break time is taken or not.

For example, if you use the random break table one day, then it is not used for two days, record the date on the second and third lines and use the time on the fourth line for a break on the fourth day.

The RBT is made up of three columns: “DATE,” “TIME” and time change (Δ). Beginning at the top of the DATE column, enter the date of the first day you use the RBT. The TIME column will indicate when your six hour break starts. If you need to change the specified break start time, record the time change in the third column as illustrated on Figure 2-6. Once you start using the RBT, work down the first column by filling in the date of each day whether or not a break is taken.

You are responsible for all the “on” hauls brought aboard the vessel prior to the start of your break, so you may not actually start your break at the time indicated on the table. For example, you are on a longline vessel following only the RBT, and your break starts at 0400 hours. The vessel picks up a set at 0345. You need to sample this set, since it started being retrieved before your break began. When you finish sampling the haul at 0600, you would start your six-hour break. To document your change, draw a line through the 0400 on the table and write 0600 next to it, in the time change (Δ) column (see Figure 2-6) *Additionally, if you are too exhausted to wait for your break, follow the same documentation procedure, and write the circumstances in your log book.*

Random Break Table Use Summary

- Take a break only on days you need it.
- If the retrieval time of an “on” haul is before your break time, complete your sample before taking your six-hour break.
- Break for six hours unless otherwise instructed by NMFS staff.

- Sample the next “on” haul which has a retrieval start time after the end of your six-hour break.
- Hauls retrieved during your break continue to be counted against the Random Sample Table.

| DATE | TIME | Δ |
|-------|-----------------|------|
| 01/06 | 0400 | 0600 |
| 01/07 | 1300 | |
| 01/08 | 0400 | |
| 01/09 | 1800 | 1915 |
| 01/10 | 1500 | 1630 |
| 01/11 | 0400 | 0345 |
| 01/12 | 0300 | |

Figure 2-6: Properly Completed Random Break Table

Documenting RST and RBT Use

Your use of the Random Sample and Random Break Tables must be documented on the Observer Haul Form. Fill in the “Random Sample Table” and “Random Break Table” columns to indicate what tables you were using. If you are using the RST in combination with the RBT, see Figure 4-13 on page 4-29 and Figure 7-9” on page 7-27 for proper documentation. If you use the RBT, staple it into your logbook, so that any changes you made regarding when you took a break are properly documented.

If Your Sampling Schedule is Too Rigorous

If you find that you cannot sample all the “on” hauls on a vessel, or that your other work is suffering, there are a few things you can try:

1. If you are on a CP or mothership and are only using the RST, start using the random break table on some or all days.
2. Reduce your sampling time by reducing the sample sizes of one or more hauls in the “on” haul series. *It is preferred to have random, smaller samples from more hauls than large samples from fewer hauls.*
3. Look ahead at your schedule and plan to make best use of your rest time. For example, if your RST reads that you have a four-on, one-off, four-on series

coming up, try getting more rest before this series. Complete paperwork, nap, and eat between samples so you have a larger block of rest time during your off haul.

4. If you get caught in an unworkable situation, you can skip one of the hauls in the series to be sampled. If you do not sample an “on” haul, continue sampling the rest of the series as if you had. In the four-on, one-off, four-on series example, if you needed to rest for two hauls, you would sample four hauls, rest for two, and sample three hauls to complete the series. If it is necessary to skip “on” hauls on a continuing basis, contact the Observer Program for advice. Do not sample off hauls to make up for skipped on hauls!
5. If you are having difficulty following the RST or RBT regularly, contact NMFS for assistance (see “Contact Addresses and Numbers” on page A-61). Do not use a solution that has not been approved by NMFS!

Frequently Asked Questions About the RST and RBT

Q1: I am supposed to sample four hauls in a row. The third haul comes up at 1450, and I am scheduled to begin a break at 1500. Do I sample that haul?

A1: Yes. Sample the third haul in that block and then take your 6-hour break. When you finish your break you will re-enter the RST. To re-enter, check the fishing schedule against the RST to see when the next “on” haul will be retrieved.

Q2: A haul is retrieved at 0945 and my break starts at 1000. According to the instructions, I should sample this haul, but they don’t begin processing until after the fish have aged for four hours. Do I sample this haul?

A2: Yes. While you are waiting for them to begin processing, you can do paperwork, laundry, eat, etc. After you complete your sampling you may begin your 6-hour break if needed, or skip the break for that day.

Q3: Can I skip breaks and only take them on a few days when I need to?

A3: Yes. On the table, record the date of each day whether or not a break was taken. You cannot accumulate break time by skipping a day and taking a longer break the following day. You cannot take more than one break per day.

Q4: Can I sample more hauls than those indicated on the RST?

A4: No. Do not sample “off” hauls on the RST unless you can sample all the hauls. If the number of hauls taken by the boat was overestimated, you may switch to a more rigorous RST. You should not switch more than once unless the vessel changes fisheries or fishing activities.

Q5: My break is over and the haul currently being processed is an “on” haul and is about half processed. Can I take samples from the remaining portion?

A5: No. Since the catch is already half processed, half the population from which you want to sample is unavailable to you. This would interfere with your random sampling design. Additionally, you were not present to verify that no presorting, or other unusual sorting, occurred. Use this time to complete paper work, get some more sleep, or take some down time for yourself.

Q6: Suppose my break is just ending and the next haul retrieved is an “off” haul, resulting in a longer break than I need. Should I stick to the RST and not sample?

A6: Yes. You must sample only the designated hauls, resulting in a longer break than the six hours scheduled. Consequently, you may not need to take a break the next day.

Q7: I was just assigned to a different vessel (or, my vessel just completed a delivery and is resuming fishing). How does this effect my use of the RST?

A7: When you are assigned to a new vessel, or when fishing resumes after a delivery, continue where you left off on the table if you were in the middle of an “on” series, or were going to start another. If you left off in the middle of an “off” series, or were going to start another, skip to the next “on” series. Your first haul of each new vessel or trip should be an “on” haul.

INTRODUCTION TO SAMPLING THEORY

The following section explains some of the basics of sampling theory. For vessel specific sampling instructions, refer to the appropriate sections within this manual.

This section addresses the methods and tools available to observers to sample in a commercial fishing setting and how to deal with the challenges encountered.

Populations

A population is a group of items or organisms from which representative samples are collected, and from which we want to make statements about. Sampling allows data users to gather information about a population. Fisheries observers collect samples to make statements about the population caught in a particular haul. In a perfect world, observers would census this population: all the organisms caught are accounted for. However, in most situations a census for every individual would be impractical.

The group of organisms in a population that the observer is making statements about is referred to as the target population. In contrast, the sample population is the portion of the target population that the observer has access to. Ideally, the target population should always be equal to the sample population.

The observer's goal is to ensure that the sample population represents the target population by using methods that are consistent, measurable and defensible. Any factors that affect this goal should be thoroughly documented in your logbook and will be discussed during debriefing. *Through sampling you will provide crucial information necessary for fisheries management.*

Sample Units and Sample Frame

Once a target population is defined, observers must decide how to sample it. When you cannot census the population, you must first divide this population into equally sized sample units. The list of the units that comprise a population is called the sample frame.

Sample Design

You must adopt an adequate random sampling design for your sample to accurately reflect the population. The sample design is the plan drawn up before data are collected from a given population. Each sampling design defines which sample units are selected at random from the sample frame. By incorporating randomness into your sampling, each and every individual has an equal chance of being in your sample, thus adequately representing the population and minimizing bias.

Keep in mind that the more you can sample from a population the better. The larger the overall sample size, the more precise the associated estimates become.

What Does All This Mean for You?

The Bering Sea and Gulf of Alaska Fisheries are among the best managed in the world, in large part due to the data collected by observers. Fisheries managers and other data users rely heavily on observer data and also rely heavily on the assumption that these data have been collected a specific way. It is your job as a North Pacific Fisheries Observer to collect data in the manner dictated by this manual and Observer Program staff, and to fully document those instances for which you are unable to do so.

Sampling decisions must be made on a haul by haul basis as each haul's population is unique and may present different challenges that alter how each data point can be collected. You are expected to apply the lessons learned from one sample to improve the samples of subsequent hauls and work to overcome any sampling challenges. With practice and increased familiarity with vessel operations data collection methods will improve. Your overall success and the quality of your data are dependent on your ability to remain flexible and continue to improve your methods throughout your deployment.

There are three key elements to always consider when planning your sample collection:

1. **Random** - All samples should be **random** and made up of approximately equal sized units. A single random sample is better than several non-random samples unless you can collect **all** the sample units that are available to you.
2. **Multiple samples** - You must maximize the **number** of samples taken per sampled haul. A minimum of 3 samples is always preferred. **At least three samples are necessary for the estimation of variance!**
3. **Large samples** - You must maximize the **size** of your samples per sampled haul, with equal sized samples. Larger samples increase the ability to detect rare species that occur in the catch.

Sampling Steps: The Basics:

Before you start sampling, you must have a well established sampling plan. You must carefully consider the following:

- Total amount of organisms you can quantify (sort, count, weigh) in one sample;
- Time needed between sampled units of your sampling frame; time between hauls;

- Your energy level;
- Space available to store samples.

A synopsis of sampling steps are outlined below. These steps are addressed again in the chapters of this manual specific to vessel type:

1. **Define the population.**

- **Target Population:** The target population is the entire group about which we want to draw inferences. In our fisheries, the target population for species composition sampling is always all the fish in a codend, in a longline set, or in a set of pots.
- **Sample Population:** The sample population is the portion of the target population that is physically available to the observer to be collected.
- Ideally the sample population should always be equal to the target population. However, in a commercial setting this is not always the case. Observers are expected to recognize when the sample and target population are not equal, and take steps to minimize any associated bias by using all of the tools available.

2. **Define the sample units and create a sample frame.**

- Sample units represent the individual items a sample population is divided into. Sample units should be of equal size, as large as possible, and measurable. *Sample unit size must be manageable, because every organism in the unit must be collected and accounted for.*
- Divide the target population into equal sized units to create the sample frame: the sample frame is the list of measurable sample units that comprise the sample population that the observer has access to. *Each fish should only be included in one sample unit.*

3. **Define your sample design to select the sample units.**

- **Sample design:** The sample design is the plan the observer is following in order to randomly select the sample units from the sample frame. Random selections must be unique to each new population (haul, longline set, pots) and as large as possible for a given situation. The size of your sampling unit should be manageable: you must collect or otherwise account for ALL the animals within a single unit. Animals or sample units that can not be sampled (are presorted, or unavailable to the observer) are

not included in the sample frame, and are therefore not part of the sampled population.

- **Select the sample units:** Based on the sample design for a haul, the observer will select the units to be sampled from within the sample frame. Units that can't be sampled should not be included in the sample frame. You will always be working with spatial sample frames that consist of units of space such as sections of a bin, codend, or trawl alley, sections of gear, pots, or weight based units. Follow these two basic steps:

Step 1- Consecutively number the units in the sample frame.

Step 2- Generate random numbers to select which sample units to include in your sample.

Random numbers can be generated using the Random Number Table provided to you. Other approved methods include dice, cards, or an analog watch. Check with your inseason advisor before using any other method not listed to generate your random numbers.



New random numbers must be generated every time the sample population changes and for each sample design you create.

- For a simple random selection (SRS) determine the number of samples you want to collect. Using the RNT or other approved method, pick a random number from one to your maximum sample unit number to represent each unit to sample. The randomly generated numbers represent the units to sample.

- For systematic random samples (SYS) determine the sample interval based on the number of samples you plan to collect. Randomly select a starting unit within the first sample interval and continue to sample every nth sample unit thereafter. Step by step instructions for determining an appropriate sampling interval are discussed more fully in this manual's vessel specific chapters.

4. **Collect the randomly chosen units and work up your sample.**

- You must account for all of the organisms from each selected unit. All sample units within the sample frame should have equal probability of being selected. For example, if the spatial frame breaks the catch on deck into a grid pattern, then

ESSENTIAL INFORMATION : SAMPLE UNIT TYPE FOR SPECIES COMPOSITION

a single grid area is a sampling unit, and you must be able to collect all the organisms from this area. On a longliner, a sampling unit could be a single segment of gear. On a pot boat the sample units could be a single pot or a group of any number of pots. *The one requirement for all these options is that unit size must be consistent throughout the frame. Plan your sample and sample your plan!*

SAMPLE UNIT TYPE FOR SPECIES COMPOSITION

The sample unit type describes how the sample population is divided to create the sample frame. In most cases, your sample frame will be based on units of gear (longline and pot vessels), or targeted weights of fish (trawl vessels). However, there are a few other sample unit types available. Sample Unit Types used in our program are:

Gear (Code 1): Use when the sample frame consists of units defined by discrete segments of gear, such as longline segments (skates, magazines), individual pots, or a group of pots. This is the only sample unit type available for fixed gear vessels.

Time (Code 2): This sample unit consists of a predetermined time interval from which all fish within the time interval would be collected. This sampling

method is not preferred and if you are unable to define a spatial sample unit, contact NMFS. Do not use this code for time as a proxy. Determine what time is a proxy for (gear, weight) and use that code.

Weight (Code 3): This sample unit is a predetermined weight of fish. Use this code when the sample frame is a list of equal weight units, and all the fish within that weight unit can be collected. Use this code when an opportunistic sample is collected but you are able to collect a predetermined weight of fish. This unit type is the most common on trawl vessels. If your trawl vessel is equipped with a flowscale, you must always use a weight based unit.

Volume (Code 4): This unit type is a predetermined volume of fish in a container. This sample unit type is rare and generally applicable to trawlers.

Other (Code 5): This sample unit type is used as follows:

- Anytime that the unit defined within the sample frame cannot be collected in its entirety.
- When a sample unit cannot be identified.
- Examples: 1) On a catcher vessel trawler you define sample units using a grid in the trawl alley. You can't collect all the fish within the randomly selected units. These units are coded as other. 2) You are sampling

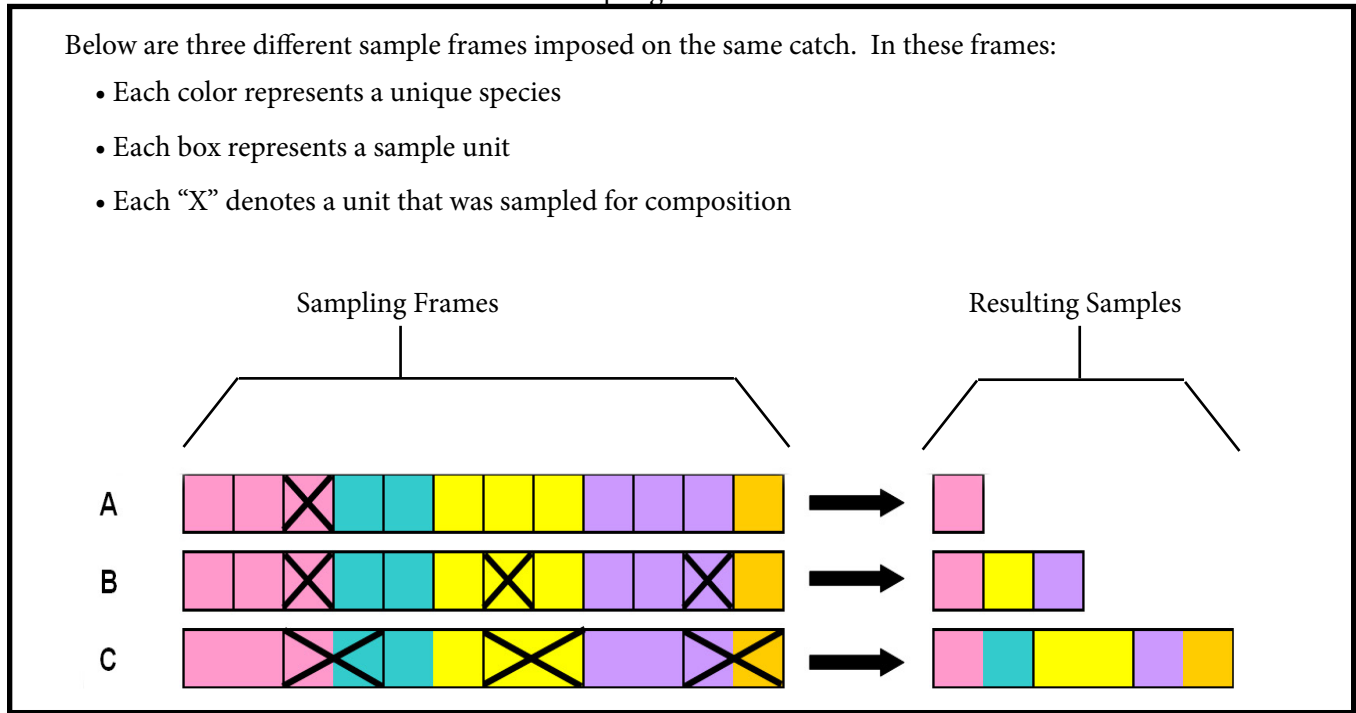

Figure 2-7: Sample frame examples showing benefits of multiple large samples over fewer small samples

a very small codend and you are not able to define discrete sampling units. You collect only fish that are available to you. The sample unit is other.

Unknown (Code 6): Use this code when you are unsure which sample unit type you are using. Contact NMFS for clarity.

SAMPLE DESIGNS FOR SPECIES COMPOSITION

Data users and Observer Program staff need to know how you collected your samples. The sample designs used by our program are described below.

Opportunistic (Code 5): This sample design is used when you are not able to incorporate any randomization in the initial selection process of your samples. Even if you can identify sample units in your population and create a sample frame you will have to sample opportunistically if you can't randomly collect the units. In this scenario, you must collect your samples as soon as the opportunity presents itself. Examples: 1) You are sampling on a trawl vessel where once the catch is dumped into the trawl alley, only one checker bin is available to sample from. You do not have safe access to any other part of the trawl alley. 2) A very small haul is retrieved, you do not have time to create a frame, and you must obtain a composition sample before the fish run out. 3) You are on a catcher vessel and only have access to three checker bins but not the entire trawl alley to collect a sample. You collect one from each of the three accessible bins. Since you did not randomize the selection of the sample units, the sample design is opportunistic.

Simple Random (Code 6): To use this sample design, you must have an established sample frame from which you select one or more random samples units and have access to the majority of the population. The selection of one or more samples is independent from each other and it could result in back to back sample units. Examples: 1) You are assigned to a longliner that sets small hauls of 4 segments each. You define 4, 1-segment sample units and you randomly select one unit. 2) You are on a catcher vessel trawler with 3 checker bin doors available to collect your spatial sample from. However you only have time to collect and work up one sample. You randomly select one of the checker bin areas.

Systematic Random (Code 7): To use this design, you must have an established sample frame from which you systematically select your random samples units and have access to all of the sample units. This sample design allows you to collect multiple sample units equally spaced throughout the entire population. Example: On a catcher processor trawler using a flow scale, you create a systematic sample frame consisting of equally sized sample units of weight and you decide to sample every third unit. You randomly select the first sample unit and continue to sample every 3rd unit thereafter until the fish run out.



Systematic Random is the preferred method for all vessels and gear types. Exceptions will be specifically noted in this manual.

Other Random (Code 9): This design identifies samples that are collected using a randomization scheme that is not listed above and that is less rigorous because of different factors that affect your ability to access the fish. This sample design is used when you don't have access to all of the sample units. Other random is commonly used on catcher trawlers where access to the trawl alley/catch is limited. Examples: 1) You are on a catcher vessel and have access to only one side of the trawl alley. You collect a systematic random sample from those fish to which you have access. 2) You collect your sample by dipping your basket into the flow of fish into the trawl alley, but can only do so on one side of the trawl alley.

Census (Code 10): You can use a census sample design when no sample frame is required because you can access and collect the entire target population.

Other (Code 11): Use for sample designs that do not conform to any of the ones defined above, and only if instructed by Observer Program staff.

Unknown (Code 12): If you do not know how to define your sample design enter this code and contact your in season advisor or NMFS field staff for assistance.

Randomized Block Design (Code 14): A randomized block design is where one or more individuals are randomly selected within a predefined group, I.E. 1 out of 5 or 1 out of 10. To implement this design, you must use the randomized block design tables provided. The tables provide a sequence of random numbers that dictate which unit within a specified sample block is selected. Currently, Randomized Block Design Sample Tables are

only used on non-pollock trawl catcher processors and motherships conducting halibut deck sorting. Specifics on how to use these tables can be found in Setting up the Halibut Deck Sort Data Forms Using Randomized Block Design Sample Table on page “Setting up the Halibut Deck Sort Data Forms Using Randomized Block Design Sample Table” on page 5-38

For detailed descriptions of the methods applied for your vessel’s gear type see “Random Sampling on Trawlers” on page 5-7, “Random Sampling on Longliners” on page 8-5, or “Random Sampling on Pot Vessels” on page 10-4.

In Figure 2-7, there are three sample frame examples. The colors represent the species composition of the haul, with one color representing one species. The first two frames, A and B, each have 12 units. The last has 6 units, each twice the size of those in frames A and B.

The units marked by a dark “X” are those that were chosen to sample. In Frame A, only 1 large sampling unit is selected, using a simple random selection (SRS) and resulting in only 1 species of fish in the sample. In Frame B, 3 smaller sampling units were selected (every 4th unit, starting at unit 3; sample interval (n) = 4). Through a random systematic sample, not 1, but 3 species of fish were selected for sampling. In Frame C, the units themselves are larger and 3 sampling units were selected (every 2nd unit starting at unit 2; sample interval (n)=2). Through a random systematic sample (SYS) and increased sample size, all of the species in the haul are represented. If these were real samples of real fish, the last sampling frame and design would provide the most accurate statement about the nature of the catch in that haul.

Documenting Sample Design Constraints or Problems

There will be times when you will not be able to maintain your intended sampling design for all samples within a haul. *If you abort or alter a sampling design for any reason, document the circumstances on the Deck Form and in your Daily Notes (See “Addressing Challenging Sampling Situations on Catcher Processors” on page 5-17, “Addressing Challenging Sampling Situations on Catcher Vessels” on page 5-12, longline vessels on page 8-9, and pot vessels on page 10-7).*



Always record the sample design code and sample unit type on the Observer Haul Form that best describes the method you used to sample.

Some scenarios in which you might have to alter your planned sample design may include:

- Having to reduce the intended sample size due to a drastic change in species composition diversity.
- You misjudge the time you need to sort a sample and fail to collect the next sample because of time constraints.
- On a longliner, you miss a segment marker, causing you to miss the sample unit that you intended to sample according to your sample design.
- On a pot boat you lose count of the pots in between samples and you are off by a few pots when collecting the next intended sample.

As you gain experience on different vessel types, you will become more familiar with vessel operations but new challenges will always arise. Learn from all successes and failures, and apply the lessons learned to become more efficient at recognizing and overcoming the challenges that might interfere with your sample plan.

HOW TO USE THE RANDOM NUMBER TABLE

To use the random number table, enter the table at a random point. The easiest way to do this is by closing your eyes and placing your finger on the table. The column and row nearest your finger is the starting point. Determine how many digits in the row you are using: if you need numbers between 1 and 250, use three digits in the row, and so on. Decide in which direction you will move through the table. Then proceed in any direction through the table (even diagonally), recording appropriate numbers and skipping numbers too high or repeated, until you have enough random numbers. Unlike on the Random Sample Table, you do not have to keep track of your position in a random number table. You should decide on a direction and enter the table at a different random starting point every time you use it.

For example, if you need to choose 3 numbers between 1 and 25, you could enter the table by placing your finger on the table to choose a column and row. Your criterion is two digit numbers between 01 and 25 (inclusive). For

this example, you decided to work up the column from your starting point. As you move up the column, the first number you encounter is 14. This is a two-digit number between 01 and 25; it fits the criterion, so you write it down. The next number is 09; it also fits the criterion, so you write it down. The next number is 58 and does not fit the criterion so you skip this number. Keep moving up the column, skipping the numbers that do not fit the criterion, until you have chosen all the numbers you need.

SUBSET SAMPLING

Subset sampling is a sampling method that provides data users with additional information on the species or species groups encountered in your samples. In the course of collecting and working up your samples, there may be occasions when it is too time consuming or impossible to weigh *and* count all, or identify all, of a single species in your sample. To handle these situations the Observer Program allows random subset sampling for number and weight or for species identification.

Subset sampling is a tool that can be used to save time, space, and energy. However it should not be over-used because actual numbers, weights, and the identification of all individuals to species provides the best information.

Subset Sample for Number and Weight

The Observer Program prefers that a number and weight be provided for all species in your composition data, but sometimes this is not possible. If a species in your sample is so abundant that you are having a difficult time counting and weighing it, you are allowed to reduce your effort by taking a small random subset sample of that species from within the larger sample. You will use this subset sample to provide critical weight and number information for the species. All remaining individuals not in the subset sample are counted (on a longliner or pot boat) or weighed (on a trawler) only. *Whether you count or weigh individuals not in the subset sample depends on vessel type and species, so you must refer to the topic of subset sampling in the vessel specific chapters of this manual!* Managers use the values supplied by the randomly collected subset sample information to determine the weight or number of the individuals of that species in the entire sample.

The implementation of subset sampling for number or weight is dependent on the gear type with which you are

working. Please refer to the trawl composition, longline, and pot vessel chapters for specific directions on subset sampling for number or weight.

Subset Sampling for Species Identification

In the process of identifying the individual specimens in your randomly collected samples, you may find fish species which are difficult to distinguish from one another. Identifying each of these fish to species may take unreasonable amounts of time, particularly if a distinguishing characteristic requires a time-consuming task such as counting gill rakers. In these situations, it is appropriate to do a random subset sample for species identification.



Subset samples for species identification are often used for rock sole, Tanner crabs, Shortraker/Rougheye Rockfish and Arrowtooth/Kamchatka Flounder groups.

To collect a subset sample for species identification, pick random portions of your composition samples (baskets, sampled time units, segments of gear) and collect all the individuals from the species group. Randomly choose between 20 and 30 individuals from the group to identify per sample. The identified animals are listed on separate lines on the Species Composition Form with the species name. The remaining individuals from the group, which were not further identified, should be weighed, counted, and recorded under the more general code for that species group.



Do not extrapolate a subset sample into the rest of your sample! Record the fish that were not identified to species with the group code (i.e., rock sole unident., code 104).

For example, you have too many fish from the rock sole group in your sample. You cannot identify each of them, so you choose two random baskets of mixed fish and remove and identify all the rock sole. Upon completion, you find that of the 29 total rock sole in the two baskets, 26 are Northern Rock Sole and 3 are Southern Rock Sole. For the species composition of that sample you would list 26 Northern Rock Sole, 3 Southern Rock Sole, and all the rock sole from your remaining sample as “rock sole unidentified.” If rock sole is the predominant species that you will be measuring, you should also use the rock soles that were identified to species for your length sample and record them on the Length and Specimen Form. An example of recording a subset sample of rock

soles can be found on the Deck Form example (Figure 5-12 on page 5-52).

USING YOUR SCALES

To obtain accurate weights, you must use the appropriate scale. If your vessel is equipped with a motion compensated electronic platform (MCP) scale which is passing daily tests, you may use this scale for all sampling purposes, including weighing individual fish for otolith or scale sampling. MCP scales can be read to the hundredth of a kilogram. Use your NMFS issued scales in the following manner:

- Use the 2.0 kg brass scale for items weighing up to 2.0 kg. This scale can be read in increments of 0.05 kilograms.
- Use the 12.0 kg brass scale for items between 2.0 kg and 12.0 kg. This scale can be read in increments of 0.1 kilograms.
- Use the 50 kg Salter scale for weighing items between 12.0 kg and 50.0 kg. This scale can be read in increments of 0.1 kilograms.
- If your scale does not register a weight, enter 0.01 as the weight for the organism.

If you board a small vessel in Dutch Harbor or Kodiak, Chatillon flatbed scales are available from the NMFS field stations. These scales have a gauge that can be read to a hundredth of a kilogram, but it is usually not appropriate to do so. Unless the weather is very calm, these scales should be read to the tenth of a kilogram, like your hanging 50 kg Salter scales. *Small, individual fish should not be weighed on the Chatillon flatbed scale.* These fish must be weighed using the 2 kg or 12 kg brass scales provided to you during gear checkout.

Although your scales look sturdy, they are susceptible to damage and excessive rust. Keep them in good working order by removing them from open areas when you aren't using them, keeping them well oiled, and storing them securely. For instructions on how to care for a Chatillon flatbed scale, see page A-66.

How to Read Your Scales in Rough Weather

Reading your hanging scales during rough weather can be difficult. The motion of the vessel may cause the indicator needle/dial to sway up and down. In these conditions, you want to record the weight where the

needle hovers over for a few moments or hovers on the same weight multiple times. This may take a few moments of observation before reading the accurate weight.

Hanging Your Scales

Locating a place to hang your scales is expected to be a challenge on some vessels. In the absence of a place to hang the scale, you may be required to take sample weights using the 2 or 12 kg scales by holding the scale in your hand.

If you are using the issued double pulleys with the 50 kg scale you must attach the scale below the pulleys for it to register accurately. Refer to the Double Pulley Handout in the Manual Packet for an example of the proper set up.

You should work closely with the captain of your vessel to identify a safe and adequate area to set up your scale and sample station. Ingenuity and creativity will be required to adapt to these situations. Document any issues that you encounter in your Daily Notes.

Taring Your Scales

It is important to tare your scales to ensure the weights you record are accurate. Every time you change a container such as a basket, you must tare the scale to account for the difference in weight among baskets. Remember to check your tare frequently since the weight of a basket can change due to the accumulation of fish slime, guts, water weight, or damage to the basket. Listed below are the steps to take for taring these types of scales.

- Salter Scale - Hang an empty basket on the Salter scale and adjust the dial on the back side of the scale. Turn the dial until the arrow points to 0.0 kg.
- Motion Compensated Electronic Scale - Place an empty basket on the scale and press the tare button. The display should read 0.0 kg with the basket on the scale. If you have any questions about taring the MCP, consult the factory manager or foreman.
- Beam Balance Flatbed Scale - Make sure the scale is not in the locked position and that all the weight indicators are at 0.0 kg. Place an empty basket on the scale and slide the metal knob on the bottom left hand corner until the 2 metal balance indicators on the right hand side of the scale are in line with each other. Always consult Observer Program field staff on how to properly use the scale before checking one out.

- Brass Scales - Turn the adjusting screw on top of the scale until the weight indicator is at 0.0 kg. The wheel must turn independently of the threaded post.

Testing Your Scales

Bring your scales into a field station at a midpoint of your cruise to re-test them to ensure they are still accurate. You must test your scales prior to use if during your most recent assignment you used an electronic or motion compensated platform scale. Your data cannot be used if your scales are not working correctly. Document these test results in the “Observer Scale Test Log” section of your logbook. If your scales do not pass testing obtain replacement scales as soon as possible and document this in your logbook.



You are expected to test your hanging scales before you deploy, at the midpoint of your deployment, and when you check in your scales at the end of your deployment, even if you have not used your scales. Record the test results in the “Observer Scale Test Log” in your log book.

If you are unable to test your scales at a field office there are a few options to explore. Plants will usually have weights to test their platforms scales. If observers are assigned to the plant, ask them where the test weights are located. If no observer is assigned to the plant, ask plant personnel if you could use them to test your scales. Plants should have test weights to test your Salter scale but will not have smaller weights to test your 2 kg or 12 kg hanging scales. To test your 2 kg or 12 kg scales make sure to test the platform scale first to ensure it is weighing accurately. Next, weigh different sized fish on the platform scale and compare the weights against your scales. Try and weigh fish that are as close as possible to the “test weights” documented in your logbook.

If you don't have access to test weights at a plant, use items of a known weight. Items of known weight include exercise weights on a boat or local gym, canned items, a bag of rice or sugar, etc.

All test results must be documented in your logbook. Document the known weight of your item and the weight that registers on your scales. Be sure to include the date it was tested and if it passed or not. When you are able to finally go into the field office, retest your scales with certified weights. Contact Observer Program staff immediately if your scales do not pass or if the results are questionable.

Maintaining Your Scales

Although your scales look sturdy, they are susceptible to damage and excessive rust. Keep them in good working order by rinsing your scales with fresh water often, shaking them as dry as possible. To properly oil your scales apply oil to the adjusting wheels, the springs of your brass scales, and inside of the Salter 50 kg. Once you are done oiling, store the scales in a bag wrapped in a paper towel. Keeping them free of salt and slime and well oiled will keep them working. For instructions on how to care for a Chatillon flatbed scale, see page A-66.



Keep your scales dry and well oiled. It's nearly impossible to use too much oil on a scale!

Electronic Scales

Electronic Platform Scale

Electronic platform (EP) scales will mostly be seen at plants and floating processors. These scales are not motion compensated. At some plants you may have up to two electronic platform scales. Both of these will need to be tested. Even though these scales are not certified by NMFS they still must pass observer testing like all scales

Motion Compensated Electronic Scales

Vessels regulated under a Limited Access Privilege Program (LAPP) must supply and use motion compensated scales. When they are required to, trawlers and longliners will have a flow scale and a platform scale on board. A few catcher vessels have flow scales, but it is unlikely that these are NMFS certified. Flow scales that are not certified may not be used for Observer Estimates or to determine sample weight; they may only be used as a sampling aid.

Motion compensated platform (MCP) and flow scales are able to accurately weigh catch by comparing the weight on two separate load cells. The first load cell weighs the object with an unknown weight (your basket of fish), the second load cell, or reference load cell, weighs a known weight. The two weights are compared at least 60 times per second. This enables the scale to compensate for motion that would otherwise cause an inaccurate weight reading. Flow scales, or conveyor scales, also monitor belt speed and incorporate that information into the weight calculations. Both scale types, when properly calibrated, provide highly accurate weights.



Flow scales are used differently for trawlers and longliners. For trawlers, the entire catch must be weighed on the flow scale. For longliners, only Pacific Cod will be weighed on the flow scale.

MCP scales are used to weigh the samples you collect. The vessel crew will also use the MCP scale to complete their daily flow scale test. Flow scales are incorporated into a conveyor belt and are used to weigh total catch on trawl CP and mothership vessels. They may be used to design a weight based random sample frame, and for larger samples, can also be used to determine sample size. If your trawl vessel is equipped with a motion compensated flow scale, and it is passing daily accuracy tests, you should use this for determining sample size and Observer Estimate. You may use motion compensated scales even if your vessel is not operating in a fishery where they are required, but they must be tested appropriately each day they are used.

MCP and Electronic Platform Scale Testing

Each observer is required to test the scale at the beginning of their shift. If two or more observers share the same shift, they may test the scale together and each observer's cruise number should be recorded in ATLAS.

To test an MCP or electronic platform scale:

- Use certified test weights to test the scale at 10 kg, 25 kg, and 50 kg. A test must be conducted at least every 24 hours when you are using one of these scales. It is recommended that observers test the scale at the beginning of each observer shift. If the scale fails, it may be retested or calibrated and retested.
- Record all passing test results on the Electronic Platform Scale Test Log in ATLAS.
- If the scale has failed and can no longer be used, record the final failing test on the Electronic Platform Scale Test Log in ATLAS. Document the situation in your logbook and notify your inseason advisor

Most plants/vessels have either gold colored or stainless steel weights. Many vessels also have standard weights (lbs) that are silver in color that they use to test their production scales. **Make sure the test weights you use are metric.**

When you test the MCP or electronic platform scale, the displayed weight should be off by no more than $\pm 0.5\%$

of the known test weight. If the scale fails at any of the designated weights it should be re-tested or calibrated and re-tested. Whether you simply re-test or calibrate and re-test will depend on the make of scale. The vessel should have a copy of the scale instruction manual and you may want to consult with the engineer or factory foreman the first time you calibrate or test the platform scale. ***The MCP scale cannot be used to determine the weight of any part of your sample if it has not passed the daily test.***

Most platform scales have a function called "marine calibration." Prior to testing these scales for the first time you should perform a marine calibration. Consult the scale instruction manual, the engineer, or a factory foreman if you need assistance.

Marine calibrations must be performed anytime you test the scale or when you notice one of the following: The scale is unstable without the platform being touched or the scale is unable to assume the initial zero point, even with an empty platform. Every time you perform a marine calibration, you will see a "Fit Level" on the MCP display. Fit levels should be in the single digits. When the weather is rough, expect the fit levels to be in the low to mid teens. If the fit level is in the 20's, the MCP will not weigh accurately and another calibration will have to take place. Consult the scale instruction manual, the engineer, or a factory foreman if you need assistance with marine calibrations. Any issues with testing the MCP must be documented in your logbook and consult your in season advisor immediately.

What To Do When the Platform Scale Fails

If the platform scale fails the daily test you should test it again. If the scale does not pass after two or three attempts, consult with the factory manager or the engineer and inform the captain/plant manager that the scale has failed. It is industry's decision whether to continue to process fish. If the vessel/plant continues to process fish you should sample for species composition using your 50 kg Salter and brass scales. You should also notify NMFS, via your inseason advisor, and document the incident in your logbook. ***Do not refuse to sample or tell the vessel/plant they can't fish if the platform scale is not functioning.*** The flow scale cannot be used to determine sample size or haul weight if the MCP scale does not pass. The accuracy of the weight used to test the flow scale is dependent on the MCP scale.



Document the serial number for any faulty platform scale(s) on your Deck Forms, Electronic Platform Scale Test Log in ATLAS, and in your Daily Notes. The serial number is found on the digital face plate.

Flow Scale Testing

On vessels where flow scales are required by regulation, the daily flow scale test must be conducted at least one time during each calendar day when use of the scale is required, with testing intervals not to exceed 24 hours.

It is the vessel's responsibility to:

1. Test the flow scale each day
2. Notify the observer that they are going to test the flow scale at least 15 minutes in advance
3. Conduct the test while you are present

Occasionally the vessel will test the flowscale and the observer was not asked to be present. In these cases the vessel is doing their own testing and it will not be considered an official test. If you do see this happening, ask the crew if this is an official test, if not, you do not need to witness or record anything.



If you are the sole observer on a longliner with a flow scale, it is important to work closely with the vessel to ensure the flow scale test is done when you are awake. Any problems scheduling these tests must be addressed with your inseason advisor.

In order to do a flow scale test, the vessel must use sandbags supplied by the scale manufacturer. Other items such as fish, bags of flour or rice and steel test weights are not approved for testing flow scales. The crew must run these sandbags over the flow scale for a total test weight of at least 400 kg. After the sandbags are weighed on the flow scale they should be weighed on the platform scale. The maximum permissible error for flow scales is $\pm 3.0\%$. Some vessels will be using a Daily Flow Scale Test Form to document the weights and perform the calculations. This information will then be entered into the ELB. Do not sign this form. Your job is to simply be present and witness that the test was done correctly. In summary, the vessel personnel's responsibilities for flow scale testing include:

- Having the scale certified by the Alaska Regional Office.
- Performing a daily 400 kg materials test, using sandbags supplied by the scale manufacturer. If your vessel is testing the flow scale with anything other than sand bags, contact your in season advisor.



The known weight of the sandbags must be determined at the time of each scale test by weighing it on a NMFS certified platform scale, before or after they are weighed on the flow scale.

- Conducting the flow scale test in the presence of an observer, to verify that the test was conducted in accordance with regulations.
- Accurately entering all flow scale tests (pass or fail) into the electronic logbook and making these data available to the observer(s).

Do not record numbers on the form, perform any calculations, assist vessel personnel with weights or weighing items during the flow scale test and do not sign the Daily Flow Scale Test Form. Again, your job is to simply be present for the test to verify it was done correctly. If you have any questions or notice inaccurate documentation of the test results in the ELB, contact your inseason advisor immediately.



If the vessel has trouble with their flow scale, have them contact Melanie Rickett, NMFS At-Sea Scale and Video Monitoring Program Coordinator. Phone: (206)526-4070.

While watching the flow scale test and sampling hauls, pay attention to the actions of the crew. The following scenarios may indicate a problem with the flow scale that must be reported to NMFS:

1. The crew needs to make adjustments to the scale prior to each test.
2. The flow scale frequently goes into fault mode during haul processing.
3. The rate-of-flow display indicates that tonnage flow per hour has changed drastically, even though the flow rate appears to be the same (e.g., the crew have been running a full belt of fish at 40 tons/hour and

ESSENTIAL INFORMATION : SAMPLE STATION REQUIREMENTS

suddenly the flow scale reads a flow at 20 tons/hour, even though no adjustments to flow rate have been made).



Flow scales must be off by no more than $\pm 3.0\%$ from the MCP scale weight.

What To Do When the Flow Scale Fails

Depending on which type of gear your vessel uses (trawl vs. longline), follow these steps if the flow scale fails the daily test:

For Trawlers and Longliners

1. If the flow scale fails the daily test, it may be re-tested as many times as the crew wishes. All test results (pass or fail) must be documented in the ELB. Contact your in season advisor if you notice otherwise.
2. If the flow scale fails, the *captain* decides whether or not to continue fishing. As an observer, your role is to simply inform the captain that the scale has not passed and that it is a violation to continue fishing with a scale that has not passed the daily test.
3. Notify NMFS, via your in season advisor, and document the incident in your logbook. *Do not refuse to sample or tell the vessel they can't fish if the flow scale isn't functioning.*

Trawlers:

The scale may *not* be relied on as a source for total catch weight until it has passed the daily test. *If total catch is weighed on a flow scale that did not pass the daily test, do not use that weight as the Observer Estimate. You must report only the Vessel Estimate, leave the Observer Estimate blank, and notify your inseason advisor.*

If the flow scale fails the daily test and the vessel continues to fish, sample for composition using the MCP scale (assuming it has passed). Your sample sizes will be limited by the fact that you must weigh the entire sample on the MCP scale.

FS/MCP Scale Weight Comparison Form

Observers on CP trawlers and motherships with a flow scale must fill out this form. See "Flow Scale - MCP Scale Weight Comparison Form" on page 5-1 for more information.



Figure 2-8: Flow Scale on a CP Trawler

Longline Vessels:

Continue sampling as normal. *The flow scale is only used by the vessel and has no impact on any observer duties.*

SAMPLE STATION REQUIREMENTS

Catcher processors participating in Limited Access Privilege Programs (LAPP) are required by regulation to have an observer sampling station. Once certified, vessels must maintain an Observer Sampling Station Inspection Report, Vessel Diagram, and a Scale Inspection Report on board and make that report available to the observer, NMFS personnel, or to an authorized officer upon request.

Sample Area When No Station Is Required

On vessels not required to maintain a certified sample station, your work space may be limited. It is critical that you work closely with the crew to establish a safe and workable area where you can sample with little interference from the crew. It is possible that your sample area will change from haul to haul or from sample to sample, though this is not usually the case.

It is essential that any gear stored on deck is stored safely and in a secured manner (usually in secured observer baskets). When securing your gear on deck, be aware that changing deck conditions may result when the vessel travels. Should the deck be the only area available to store your sample gear, be sure to secure gear so that your baskets can not flip or turn over, and spill the contents. You are responsible for your gear.

Observer Sampling Station Inspection Reports

Read the Observer Sampling Station Inspection Report when you board a LAPP vessel. Note the date the Inspection Report was issued and ensure that it has not expired. If it has, inform the master of the vessel immediately so that they can arrange for a new inspection in a timely manner. Examine the sample station diagram, and compare the setup of your station against the diagram. Before you complete your inspection of the sampling station, make sure the station is completely setup. If possible, test the platform scale before your vessel departs to make sure it passes the daily test. The scale should be turned on at least ½ hour prior to testing so that it can warm up.

If your vessel is not able to produce an Observer Sampling Station Inspection Report, inform the captain of the requirement for maintaining one on board and to request a copy from their company office. A faxed copy and original inspection report were sent to each vessel's home office following certification and the vessel should be able to obtain a copy. If the captain is unable to obtain a copy, notify your in season advisor that the vessel does not have a copy on board. ***Do not refuse to sample or refuse to embark on a vessel that can't produce the inspection report.*** Once you notify your in season advisor, NMFS will contact the fishing company and take any necessary action.

Each observer deployed on a vessel fishing with a certified sampling station must complete an Observer Sampling Station Verification Checklist in their logbook. The information you provide will be used to determine if sampling stations are functional or if modifications have been made since the station was last inspected. It is very important that you fill out the checklist completely and provide comments when necessary. You may find that your measurements are slightly different from those listed on the inspection checklist. Small differences are to be expected.

Completing the Observer Sampling Station Verification Checklist

The following should be used to complete the checklist in your logbook. Each item that pertains to your vessel type should be addressed on the checklist. Whenever possible, quantified units should be recorded. ***Both the lead and the second observer are required to return for debriefing with completed checklists.***

Sample Station:

Trawlers: If sample collection points are within the sampling station write "within station." If you are collecting and weighing your entire sample from a belt outside your station, measure from the nearest point in the sampling station to the closest point of the diverter board (or whatever device is used to collect fish from the belt). If you are sampling a large portion of the haul and sorting and weighing by catch from the belt (i.e., not weighing predominant catch on observer scales, the MCP scale, or by flowscale), measure from the nearest point in the sampling station to the closest point of the portion of the belt used for by catch collection.

Non-Trawl: There are three points to be considered for non-trawl vessels. The roller or pot launcher is the point where fish are brought onboard. The collection point is where you gather fish as they come off the line or are emptied from the pot. The tally station is the area in which tally samples are conducted. If the collection point, location where fish is brought on board, or tally station is within the sampling station write "within station." If it is outside, record the distance from the nearest point of the sampling station to the specified area.

Some C/P longliners may use both conventional longline gear and strung pots when participating in LAPP fisheries. The vessel should provide observers with a certified Observer Sample Station Inspection Report for each gear type they intend to use. You should review the documentation and discuss with the captain any differences in the sample station requirements for each gear type that may impact your duties or safety. Bring all concerns to the attention of the captain and your inseason advisor.

Minimum Work Space:

The minimum work space must be at least 4.5m², which includes the sample table. Copy the sample station

ESSENTIAL INFORMATION : SAMPLE STATION REQUIREMENTS

diagram and record the dimensions as you measure the station. If there is any unusable space (e.g., sump pump), record the areas length and width. Unusable space is defined as any area within the sample station where access to the floor is blocked or limited by another object or where height is restricted. A good test of usable space is to simulate moving, storing, and working with an observer basket. If a basket will not fit, then the space is probably not usable.

Table:

The length, width and height of the table should be recorded in the comment box. Measure the outside dimensions (i.e., from the outside of a lip, not from the end of the inside flat surface). If the table is adjustable, note that in the comment box. The area for the scale is in addition to this space, and should not be included in the measurements for the table. If there is any unusable space note the length and width of that area. Unusable table space is defined as an area where setting an observer basket is impossible.

Observer Sampling Scale Location and Height:

This refers only to the MCP scale. The shortest distance from the scale to the table and the height of the platform should be recorded in the comment box. Comment on whether or not the scale has a sticker confirming that its certification is current, what combination of weights are available, and where they are kept. Note: The MCP scale height cannot exceed 0.70 m.

Flow Scale Display Visibility (Trawlers Only):

Note if the flow scale display is readable from where you collect unsorted catch and the area where sampling takes place. Note the brand and model number of the flowscale.

Floor Grating:

Diamond plate hatch covers are acceptable in lieu of standard grating as long as drainage and slipping are not a concern. The comment box should contain notes on type, condition, and location of grating.

Lighting:

Note the number and type of lights directly in the sampling station. Any other light sources should also be recorded.

Hose:

Note whether or not the hose reaches the sampling station, the location of the water valve, and your access to the water valve.

Unobstructed Access:

This refers to movement between the sample collection point and the sample station. Note the width of passageways you must use to move baskets of fish as well as any tripping hazards or stairs. Obstructed access is any passageway less than 0.65 m wide and 1.8 m high (floor to ceiling) or a passage which is blocked or limited by objects in the passage way.

Diverter Board (Trawl Vessels Only):

The diverter board must be located after the flow scale and preferably before any sorters. Check that the diverter board is functional. Note: Some vessels have acceptable alternatives for removing catch from the flow of fish for sample collection (e.g., trap doors).

Sample Station Inspection Report:

Note the date and exact pages of the inspection report. Were the sampling station diagram and checklist presented to you with the certification letter?

Additional Comments:

This is the place to record details which are not specifically addressed in the regulations, but are of concern to the FMA Division. Specific points for non-trawl vessels are: tally station details such as location, route between sample station and tally station, and sample collection details.

Scale Inspection Reports

All scales required on LAPP vessels will be marked with a NOAA sticker signifying they are certified. Test weights will be stamped with NOAA insignia to indicate that they are certified. If a scale on your vessel does not have a valid "NMFS Approved Scale" sticker, you should ask to see the Scale Inspection Report. If your vessel is not able to produce a Scale Inspection Report, inform the captain of the requirement for maintaining copies on board. Notify your inseason advisor that the vessel does not have these documents on board. Send another message if the vessel obtains copies from NMFS or their home office. *Do not refuse to sample or refuse to embark on a*

vessel that is unable to produce a Scale Inspection Report or a weight certificate. Once you notify your inseason advisor, NMFS will contact the fishing company and take any necessary action.

Halibut Deck Sorting Sample Station Inspection Reports

Motherships and trawl CPs participating in halibut deck sorting are required to have a NMFS approved Halibut Deck Sorting Sample Station. Read the Halibut Deck Sorting Sample Station Report when you board a vessel that will be conducting halibut deck sorting. The Halibut Deck Sorting Sample Station will be located on deck and is required in addition to the Observer Sampling Station in the factory.

If your vessel is not able to produce a Halibut Deck Sorting Sample Station Inspection Report, inform the captain of the requirement for maintaining one on board and to request a copy from their company office. If the captain is unable to obtain a copy, notify your in season advisor that the vessel does not have a copy on board. *Do not refuse to embark or sample on a vessel that can't produce the inspection report.*

Each observer deployed on a vessel conducting halibut deck sorting must complete an Halibut Deck Sorting Sample Station Verification Checklist in their logbook. The information you provide will be used to determine if the sample station is functional or if modifications have been made since the station was last inspected. It is very important that you fill out the checklist completely and provide comments when necessary. You may find that your measurements are slightly different from those listed on the inspection checklist. Small differences are to be expected.

Completing the Halibut Deck Sorting Sample Station Verification Checklist

The following should be used to complete the checklist in your logbook. Each item should be addressed on the checklist. Whenever possible, quantified units should be recorded. *Both the lead and the second observer are required to return for debriefing with completed checklists.*

Access to Sample Station: Note any obstructions or impediments along the route designated for observers to access and leave the deck sample station.

Table: Record the length, width, and height of the table in the comment box. Measure the outside dimensions (i.e., from the outside of a lip, not from the end of the inside flat surface). If the table is adjustable, note that in the comment box. If there is any unusable space note the length and width of that area. Unusable table space is defined as an area where setting an observer basket is impossible. Document if the table has a barrier or lip on at least two sides that would prevent fish from sliding off the table.

Length Strip: Note the condition of the length strip secured to the surface of the table. Are the numbers on the length strip easily read? Note the material used to construct the length strip.

Work Space: Note whether or not you can stand upright in front of the table. Describe the location of the Halibut Deck Sorting Sample Station.

Halibut Pathway to Observer: Describe the pathway for halibut to be delivered to the Halibut Deck Sorting Sample Station. Are fish moved via a chute, incline belt, or crew member?

Discard Chute: Describe the discard chute.

Area Where Large Halibut Will be Measured: Describe where halibut too large to be placed on the table will be measured.

Visual Signal in Factory: Describe the visual signal that will be used to notify the crew that catch may not be run over the flow scale and weighed.

Halibut Deck Sorting Time Limit: Document the halibut deck sorting time limit indicated on the Halibut Deck Sorting Sample Station Certification Letter.

WORKING WITH MULTIPLE OBSERVERS

There are several North Pacific fisheries that require multiple observers to be assigned to the same plant or vessel. This presents observers with the opportunity to work together. Observers are expected to work together as a team to provide consistency in sampling techniques, recording data, and communications with vessel personnel. The “lead” observer will be assigned by your employer. The other observers are referred to as “second” observers Although the lead observer is not

in a supervisory position, their role is slightly different from that of a second observer.

Lead Observer's Role

The lead observer is expected to work closely with second observers and provide tutelage as needed to ensure the highest quality data. When problems occur on the vessel, the lead observer should address these immediately with crew or captain.

The lead's cruise number should be entered in all header information on paper forms and in ATLAS. You are responsible for all hauls retrieved and all deliveries completed while you are assigned as lead. You and the second observers should maintain separate Daily Notes in your own logbooks, but all calculations must be recorded in your logbook.

The lead observer is responsible for submitting the entire data set to NMFS and is required to make all necessary corrections to the data set, regardless of which observer made the error. As the lead observer, you need to know how the second observer(s) collected and recorded raw data so that you can make any necessary corrections. It is in your best interest to double check all data according to the instructions provided in the Mid-Cruise and Debriefing chapter on page 21-1. NMFS staff will try to debrief you and the second observer(s) at the same time if it is logistically possible.

Second Observer's Role

Second observers have the same responsibilities for data quality and integrity as the lead. As a second observer, you will record all the data you collect under the lead observer's cruise number except in the "Haul sampled by" column on the OHF where you will record which hauls you sampled and in the species composition "Sampled By" field completed in ATLAS. The only data that you will collect under your own cruise number are your Species ID Forms and Marine Mammal Sighting Forms. You are expected to complete all required sections of your logbook which include but are not limited to: Observer Deployment Information, Observer Scale Test Log, Vessel Safety Checklist, Diagrams of Sampling Area, Sample Station Verification Checklist, Daily Observer MCP Scale Test Log, Sampling Design Details, Fishing Effort Verification Details, MARPOL Reporting, etc. You must maintain separate Daily Notes in your own logbook. Any compliance issues that you witness should be documented thoroughly in your logbook and the lead

observer should be notified. Sampling problems that arise during your shift should be handled immediately and you should inform the lead observer during a shift change. Recurring problems should be discussed with the lead observer.

If you and the lead observer do not debrief at the same time, you will need to reconstruct your time aboard the vessel during your debriefing interview. Keep very detailed notes in your logbook regarding how you sampled and any problems you encountered to assist you in remembering specific events aboard the vessel. You may bring copies of deck sheets and other data forms to your mid-cruise or final debriefing to help you remember details of your deployment.

Shared Duties

As a part of the observer team, you are expected to maintain effective communication with your fellow observers and with vessel personnel. You should agree on a specified time between shifts to discuss pertinent fishing and sampling activities that occurred during the previous shift. Discuss any issues that come up during your shifts and work together on resolutions so that you both can provide vessel personnel with consistent and timely feedback. Each observer should document these issues in detail and notify your inseason advisor via ATLAS. During a 12 hour shift each observer is responsible for completing all data collection duties, completing required paper forms, and entering these data into ATLAS. Decide on a secure common area to leave recent data that needs to be entered or checked by your colleague. Each observer should be on duty for no more than 12 hours in a 24 hour period. If you are unable to complete all your duties within 12 hours, contact your inseason advisor for advice. Each observer should share the responsibility of collecting the data for the Trip Form, Vessel and Observer Haul Forms, and entering data into ATLAS. Additionally, each observer is responsible for, and should take the initiative in, resolving sampling problems that arise due to the vessel setup and operations. Remember that each observer should always be advised of all pertinent activities and instances related to observer duties. Be sure to establish a system of checking calculations, data, and data entry before sending data. *Checking someone else's data for errors is more efficient than checking your own- do both!*

You should work together to discuss and identify potential sample biases or challenges and establish viable

random sample designs. Since each haul represents a population and can be sampled independently, it is not necessary that each observer uses the same sample design from haul to haul. However, it is essential that a design remain the same throughout any individual haul or set. In the event that multiple observers sample a haul or set, the observer who begins the sample will decide on the appropriate random sample design and the other observer must follow that design. To aid in data correction and verification, each observer must initial the Deck Form for every sample collected. If a sample is collected by multiple observers, the Deck Form should be initialed by the observer that collected the majority of the data for that sample. The cruise number entered in the species composition “Sampled By” field in ATLAS should be that of the observer who collected the sample and should correspond with the initials. If more than one observer samples a haul, record the cruise number of the observer who sampled the majority of the haul in the “Haul Sampled By” column on the OHF.

Each of the observers should contact NMFS if there are significant differences of opinion concerning sampling methods. Each observer must describe their sampling technique thoroughly. The inseason advisor will advise you on the proper course of action.

PRE-OFFLOAD MEETINGS WITH INDUSTRY FOR BERING SEA POLLOCK DELIVERIES

Pre-offload meetings are essential to ensure all Bering *Sea pollock deliveries* are monitored in their entirety for salmon bycatch. These meetings are intended to provide a means of communication between the vessel and plant observers, plant personnel, and vessel personnel. The pre-offload meetings are NOT intended for the plant or vessel personnel to dictate observer activities. Pre-offload meetings are expected to take place when catcher vessels targeting Bering Sea pollock come in with fish on deck, have fish in a live tank, or when interruption of offloads take place. Below are guidelines for the pre-offload meetings for these specific situations.

- **Vessel arrives with fish either in a codend, live tank, or with fish loose on deck:** In this scenario the plant will offload these fish in one of two ways. They will either transfer fish on deck or fish in a live tank to the RSW tanks before the fish are pumped into the factory or they will pump the fish directly into the plant. In

either scenario, both the vessel and plant observer will be needed to monitor the offload and a pre-offload meeting should be held to coordinate the efforts of the observers and industry to ensure no sorting or discard of salmon occurs. The following individuals are expected to be present at the pre-offload meeting: the plant observer on duty, the observer assigned to the offloading vessel, plant personnel and a crew member from the offloading catcher vessel. This group will coordinate a plan for ensuring the codend, loose fish on deck, and/or live tank transfer to the RSW tanks is monitored by an observer. At the pre-offload meeting the following topics need to be discussed and agreed upon by all individuals:

- The expected date and time for fish on deck or in the live tank to be pumped into the plant or transferred to the vessel’s RSW tanks.
- Any potential conflicts with other observer duties during the transfer expected time.
- A notification procedure.
- Any other issues that may occur during the offload.

In the event that only one observer is available at the time of codend or live tank transfer, the sorting on the line will be stopped, and all fish upstream from the last point of sorting will be removed so that the one observer on duty may monitor the dumping of the codend or the live tank transfer to the RSW tanks. Once the codend or live tank transfer to the vessel’s RSW is complete and the observer on duty has returned to the sorting line, movement of fish on the sorting line and any sorting of the offload will resume.

- **A vessel offloading is interrupted for another vessel’s offload:** In the event the plant will need to switch vessels during an offload, a pre-offload meeting will be conducted to ensure the plant and vessel observers, as well as the dock crew and the vessel personnel, are prepared and informed of the offload plan. When the vessel that will be interrupting the current offload arrives, each vessel observer and a crew member from both the vessel currently under the pumps and the vessel that will be interrupting the offload, the plant observer on duty, and plant personnel are expected to be present at the meeting. At the meeting the following topics need to be discussed and agreed upon by all individuals:

- The expected date and time of the beginning of the partial offload.
- The expected date and time of the completion of the partial offload.
- Any potential conflicts with other observer duties during either offload time.
- A notification procedure.
- Any other issues that may occur during the offload.

At the completion of each partial offload the same procedures must be followed as the completion of a full offload. The sorting on the line will be stopped and any fish upstream from the last point of sorting will be removed so the observer on duty can count and sample the salmon; the salmon will then be removed from the salmon storage area once the observer has completed their sampling duties.

All pre-offload meetings must be documented in the daily notes section of your logbook. A note that a pre-offload meeting took place before the delivery is sufficient. If you have any questions about pre-offload meetings, reference the plant's Catch Monitoring and Control Plan (CMCP) and/or contact your inseason advisor.

INSEASON ADVISORS AND INSEASON MESSAGES

Staff acting as inseason advisors will be assigned to observers deployed on vessels and plants equipped with ATLAS.

Inseason advisors are available to answer sampling, and data recording questions, and assist you with any other concerns you may have. *Be sure to alert your inseason advisor when you first board a vessel or arrive at a plant.* Your inseason advisor will not know of your deployment status until you send the first message.

All communication with NMFS staff while you are assigned to a vessel or plant must be done using the ATLAS messaging system. During your deployment, do not use your personal email to contact your advisor or NMFS staff unless accessing your own email is the only means of secure communication.

There are a few vessels, primarily participating in the rockfish and the pollock fisheries that are equipped with ATLAS but do not have transmission capabilities

allowing for the sending and receiving of ATLAS messages. On these vessels your data must be submitted once you get to port (see “Entering and Transmitting Data Using a USB Flash Drive” on page 18-28). If you are deployed on one of these vessels you will not have an inseason advisor. If assigned to a vessel without data transmission capabilities, using your personal email to seek guidance from NMFS staff is acceptable.

See “INSEASON advising” on page 21-5 for detailed information regarding inseason communication protocol.

First Message to Inseason Advisor

Send a test message when you first board a vessel to make sure ATLAS is able to open and to send. See “Examples of First Messages to Inseason Advisor” on page 21-7 for further instructions and guidance.

Illness or Injury

If you have an illness or injury that prevents you from completing your assigned duties, you must inform NMFS and your contractor immediately. If communications are not readily available on your vessel or if you need immediate assistance, notify your captain. You are expected to provide daily updates to NMFS staff and your contractor regarding the status of your situation. If your condition does not improve and continues to affect your work, your assignment may need to be changed to protect your health and well being. If you are not able to communicate on a daily basis, keep your captain informed of any changes and contact NMFS and your contractor as soon as you arrive in port. See “Illnesses and Accidents” on page 19-11.

Marine Casualties

Notify your inseason advisor promptly regarding marine casualties even those that are not immediately threatening. See “Marine Casualties” on page 19-12 for descriptions of marine casualties.

Emerging Fishing Technology

Commercial fishing is an innovative industry with vessels always trying and introducing new technologies. Examples are “cod stunners” (devices that shock cod), specialized acoustic devices that produce sound waves to deter marine mammals, or new excluder technology. If you are assigned to a vessel and see technology that you've not heard of before, or was not discussed in

briefing or training, inform your inseason adviser or stop by an Observer Program office.

SENDING DATA

During the course of your cruise, you may need to contact NMFS for many reasons, but the most common reason is to send your data. The data you collect at sea is vital for inseason management. When the Observer Program receives your data, preliminary quality control checks are done, and the information is made available to the Sustainable Fisheries Division in Juneau. This division uses the observer data to determine how much catch has been removed from each regulatory area. If you do not submit data on time, and in the proper format, the Observer Program cannot provide the information necessary for making sound management decisions.

It is important to note that you must send complete data only. Sending incomplete data (e.g., haul information without the associated species composition data) can affect how the data are being extrapolated. This applies to both ATLAS and fax data. Observers on catcher vessels (with or without ATLAS) may send their data if the only missing data point is the fish ticket information on the Offload Form. In the GOA pollock fishery, offload data must be sent when transmitting your data (even when the fish ticket information is not available). The instructions on what to send are outlined on page 4-21.

Non-Fishing Days

A non-fishing day is one during which no hauls were retrieved while you are assigned to your vessel. All days aboard must be accounted for with either a fishing or non-fishing position. This is the Observer Program's only way to account for the number of days you were assigned to a vessel. Refer to each gear type specific chapter for information regarding how to record non-fishing days.

Sending Data via ATLAS

Observers are required to transmit data via ATLAS once per day. If you are deployed on a vessel that does not have at sea transmission capabilities, you are required to send data once your vessel returns to port after every trip. Even if your vessel has not fished or your plant has not received deliveries in this time period, you should still transmit non fishing data. If your vessel landed catch, but you were unable to sample for a full day, you must include an inseason message explaining why you did not sample. The Observer Program needs to be able to verify

that data was not collected on that day. Plant observers must document non-delivery days on the Offload Form. For more information on sending data via ATLAS, refer to page 18-26

Correcting and Resubmitting ATLAS Data

If you are on a vessel or at a plant with ATLAS and you need to edit your data, see "ATLAS INSTRUCTIONS" on page 18-1 for specific instructions. Any data that you edit in ATLAS will automatically be sent to Seattle the next time you prepare and transmit data. If you are asked to resend ATLAS data, select a haul or date range before you prepare your data to be transmitted.

This page intentionally left blank



TRIP INFORMATION

Table of Contents

| | |
|---------------------------------------|-----|
| Introduction | 3-1 |
| The Trip Data Form | 3-1 |
| What Is A Trip? | 3-1 |
| Trip Data Form Instructions | 3-1 |
| Time Lost At Sea | 3-2 |

INTRODUCTION

Trip data information will allow economists to better define the duration of fishing trips and to understand how fishing trips change as fisheries regulations, markets and institutions evolve. All vessel observers complete this form.

THE TRIP DATA FORM

What Is A Trip?

For our purposes, a trip is defined as “any time a vessel that you are assigned to unties from the dock at a port, floating processor, tender vessel, or trampler, and upon completion of that trip the vessel returns and ties up to a dock in a port, at a processor, tender vessel, or a trampler”. Observers are only responsible for documenting trips for which they were physically on board the vessel. There may be times where a vessel trip doesn’t include any fishing. Even though no fishing took place during your deployment, this still needs to be recorded as a trip.



Trip number must be associated with the cruise and permit number. If an observer is the second on a boat, but becomes lead after a lead disembarks, the initial trip number must be “1”. Trip number information is unique to the cruise number/permit number combination.

Trip Data Form Instructions

Cruise, Permit, Year: Enter the cruise number supplied in your training or briefing. Vessel permits can be found on page A-31. For “Year” you can enter the full year or just the last two digits (e.g., “17”).

Observer Name/Vessel Name: Enter your name and the name of the vessel.

Page Numbers: Number the pages “Page of” starting with page one for each vessel or plant and ending with the total number of pages.

Trip Number: Start with 1 for each vessel when you are the lead or sole observer. It is not necessary to skip lines between trips.

Crew Size: Enter the total number of crew (including the captain) assigned to the vessel at the beginning of each trip. Do not include observers, researchers, passengers, or any other person not associated with vessel operations.

Fish in hold at trip start?: Enter “Y” if there are fish or product in the hold at the start of the trip. Enter “N” if the hold is empty.

Port Codes: Use the table on A-27 to determine the port code of the port the vessel is leaving from or returning to. Enter the port code in the “Port of Trip Start” or “Port of Trip End” column and leave the latitude and longitude columns for trip position data blank. For example, if your boat ties up to a trampler in Dutch Harbor, the port code would be 3. If the vessel is docked at a port, catcher processor, trampler or tender that is not listed in the table, use code 17- “Other”. If you use the “Other” code, you must enter position data in the trip start and/or trip end position columns. For at-sea transfers, use code 18- “Transfer At Sea” and enter position data.

Trip Start Position: If you leave from a port, floating processor, tender or trampler that is not listed in the table, use the “Other” code and list the latitude and longitude of the port in the trip start position. If you transfer at sea, use code 18 and enter position data. Read the position directly from the ships GPS or ask the captain for the positions. One hundred plus degrees of longitude are assumed so do not enter the “1”. Record the position to the level of accuracy available and to the nearest second. Vessels may record positions to the nearest minute,

TRIP INFORMATION: THE TRIP DATA FORM

seconds, or hundredths of a minute; in this case you must convert this value to seconds. Use the conversion chart on page A-45 to convert from hundredths of a minute to seconds. Do not enter degree marks. Degree, minute, and second entries must be two digits. Complete the “E or W” column to indicate if the longitude is east or west of the 180 degree line.



Observers are allowed free and unobstructed access to navigation and communication equipment on request.

Start Date: Enter the month and day the vessel departed the port, processor, tender, or trampler. The month and day must be two digits (e.g. 01/01 for January 1st).

Time of Trip Start: Enter the time the vessel left the port, processor, tender, or trampler. If transferring at sea, record the time you boarded the vessel. Use 24 hour time notations, in four digits with no colons. Enter all 2400-hour notations as 0000 hours which starts a new date.

Trip End Position: If you return to a port, floating processor, tender, or trampler that is not listed in the previous table, use the “Other” code and list the latitude and longitude of the port in the trip end position. If you transfer at sea, use code 18 and enter the latitude and longitude where the transfer occurred. Follow the same rules as described for “Trip Start Position” when entering the position information.

End Date: Enter the month and day the vessel ties up to a dock at a port, processor, tender, or trampler. The month and day must be two digits (e.g., 01/01 for January 1st).

Time of Trip End: Enter the time the vessel ties up to the dock in port, tender, trampler, or processor. If transferring at sea, record the time the transfer occurred. Use 24 hour time notations, in four digits with no colons. Enter all 2400-hour notations as 0000 hours which starts a new date.

Did fishing occur?: Enter “Y” if the boat you were assigned to actually retrieved gear during the trip. Enter “N” if the vessel did not retrieve any gear during this trip.

Bait Used: Enter the appropriate code of the bait the vessel is using. Use code 9 - Not Applicable, when no fishing occurred or if your vessel is not using fixed gear (i.e., trawl vessels). If the vessel is using a bait that is not listed, enter 7- Other. If the vessel is using a combination of baits listed use 8-Combination. When using code 7 -

Other or 8- Combination write in the type of bait they were using in the comment section on the bottom of the page.

| Bait codes and descriptions | |
|-----------------------------|------------------|
| 1-Herring | 6-Salmon |
| 2-Squid | 7-Other |
| 3-Octopus | 8-Combination |
| 4-Pacific Cod | 9-Not Applicable |
| 5-Sardines | |

Time Lost at Sea (Hours): Time lost is any time something unexpected occurs while at sea that changes the ability of the vessel to fish and it has to spend time waiting or repairing something they otherwise wouldn’t have done. If the problem results in the vessel returning to port, the time spent in transit should not be included in the time lost sea. Time at anchor waiting to offload or to go out to fish is not time lost at sea. Time at anchor due to weather is time lost at sea.

Record time lost at sea as one of the following options: Mechanical problem, Weather related problem, Crew related issue (accident or other problems), USCG/ Enforcement related stoppage, Marine Mammal interaction/depredation, and Other. If “Other” is used please provide an explanation in the comments section at the bottom of the page. If no time was lost while the vessel was out fishing, leave all time lost columns blank.



Time lost at sea must be recorded to the nearest whole hour.

Example: A vessel experiences problems with the net reel hydraulics at 0230 that prevents the deployment of the net. The crew attempts to repair the net at sea. At 0400 the captain decides to return to port for repairs and arrives in Dutch Harbor at 1600. The vessel lost 1.5 hours at sea (0230-0400). The observer records 2 hours of time lost at sea under Mechanical Problems.

| Cruise 25670 | Permit 2345 | Year 2023 | Trip Data Form | | | | | | | | | | Page 1 of 1 for vessel | | | | | | | | | | | | | | | | | | | |
|-----------------|----------------|------------------------|--------------------------------------|---------------------|------|------|--------|-----------------|------|------------|-------|--------------------|--------------------------------------|-------------------|--------------|------|------|--------|-----------------|----------|------|------------------|--------------------|------------|--------------------------|-----|---------------------|--------------------------|---------------------|-------------------------------------|-------------------------------------|-----------------------|
| | | | Observer name <u>Reginald Dwight</u> | | | | | | | | | | Resubmission (Circle All Changes) | | | | | | | | | | | | | | | | | | | |
| | | | Vessel name <u>Honky Cat</u> | | | | | | | | | | | | | | | | | | | | | | | | | | | | | |
| Trip No. | Crew Size | Fish in hold at start? | Port of Trip Start | Trip Start Position | | | | | | Start Date | | Time of trip start | Port of Trip End | Trip End Position | | | | | | End Date | | Time of Trip End | Did fishing occur? | Bait Used? | Time Lost at Sea (Hours) | | | | | | | |
| | | | | Latitude (N) | | | E or W | Longitude (100) | | | Month | | | Day | Latitude (N) | | | E or W | Longitude (100) | | | | | | Month | Day | Mechanical problems | Weather related problems | Crew related issues | USCG / Enforcement related stoppage | Marine Mammal interaction/predation | Other (include notes) |
| | | | | Deg. | Min. | Sec. | | Deg. | Min. | Sec. | | | | | Deg. | Min. | Sec. | | Deg. | Min. | Sec. | | | | | | | | | | | |
| 1 | 5 | N | 3 | | | | | | | 07 | 12 | 0600 | 3 | | | | | | | 07 | 12 | 0630 | N | 9 | | | | | | | | |
| 2 | 5 | N | 3 | | | | | | | 07 | 12 | 0800 | 14 | | | | | | | 07 | 15 | 1230 | Y | 9 | | | | | | | | |
| 3 | 5 | N | 14 | | | | | | | 07 | 16 | 0417 | 14 | | | | | | | 07 | 19 | 1026 | Y | 9 | | | | | | | | |
| 4 | 5 | N | 14 | | | | | | | 07 | 20 | 0120 | 14 | | | | | | | 07 | 20 | 0135 | N | 9 | | | | | | | | |
| 5 | 5 | N | 14 | | | | | | | 07 | 20 | 0346 | 14 | | | | | | | 07 | 22 | 1410 | Y | 9 | | | | | | | | |
| Comments: | | | | | | | | | | | | | | | | | | | | | | | | | | | | | | | | |

National Marine Fisheries Service / Fisheries Monitoring and Analysis Division Page _____ of _____ for transmission Rev. 09

| Cruise 25007 | Permit 5676 | Year 2023 | Trip Data Form | | | | | | | | | | Page 1 of 1 for vessel | | | | | | | | | | | | | | | | | | | |
|--|----------------|------------------------|----------------------------------|---------------------|------|------|--------|-----------------|------|------------|-------|--------------------|--------------------------------------|-------------------|--------------|------|------|--------|-----------------|----------|------|------------------|--------------------|------------|--------------------------|-----|---------------------|--------------------------|---------------------|-------------------------------------|-------------------------------------|-----------------------|
| | | | Observer name <u>Lars Ulrich</u> | | | | | | | | | | Resubmission (Circle All Changes) | | | | | | | | | | | | | | | | | | | |
| | | | Vessel name <u>Orion</u> | | | | | | | | | | | | | | | | | | | | | | | | | | | | | |
| Trip No. | Crew Size | Fish in hold at start? | Port of Trip Start | Trip Start Position | | | | | | Start Date | | Time of trip start | Port of Trip End | Trip End Position | | | | | | End Date | | Time of Trip End | Did fishing occur? | Bait Used? | Time Lost at Sea (Hours) | | | | | | | |
| | | | | Latitude (N) | | | E or W | Longitude (100) | | | Month | | | Day | Latitude (N) | | | E or W | Longitude (100) | | | | | | Month | Day | Mechanical problems | Weather related problems | Crew related issues | USCG / Enforcement related stoppage | Marine Mammal interaction/predation | Other (include notes) |
| | | | | Deg. | Min. | Sec. | | Deg. | Min. | Sec. | | | | | Deg. | Min. | Sec. | | Deg. | Min. | Sec. | | | | | | | | | | | |
| 1 | 56 | N | 3 | | | | | | | 06 | 27 | 1900 | 3 | | | | | | | 06 | 30 | 0200 | Y | 9 | | | | | | | | |
| 2 | 56 | Y | 3 | | | | | | | 07 | 01 | 0100 | 3 | | | | | | | 07 | 02 | 1200 | Y | 9 | 2 | | | | | | | |
| 3 | 55 | N | 3 | | | | | | | 07 | 03 | 0200 | 3 | | | | | | | 07 | 12 | 1045 | Y | 9 | 15 | | | | | | | |
| 4 | 55 | N | 3 | | | | | | | 07 | 13 | 0900 | 3 | | | | | | | 07 | 23 | 1730 | Y | 9 | | | | | | | | |
| 5 | 55 | N | 3 | | | | | | | 07 | 25 | 0100 | 17 | 53 | 50 | 12 | W | 66 | 10 | 24 | 07 | 27 | 0620 | Y | 9 | | | | | | | |
| 6 | 56 | N | 17 | 53 | 50 | 12 | W | 66 | 10 | 24 | 07 | 27 | 1500 | 3 | | | | | | 07 | 27 | 1600 | N | 9 | | | | | | | | |
| Comments: Trip #2- Repairing engine Trip #3- Stopped fishing until weather improved | | | | | | | | | | | | | | | | | | | | | | | | | | | | | | | | |

National Marine Fisheries Service / Fisheries Monitoring and Analysis Division Page _____ of _____ for transmission Rev. 09

Figure 3-1: Trip Form Examples

This page intentionally left blank

TRAWLER CATCH DATA



Table of Contents

| | |
|--|------|
| Priorities | 4-1 |
| Safety Onboard Trawlers | 4-1 |
| Documenting Fishing Effort | 4-2 |
| Logbook Requirements for Vessels 60ft or Greater | 4-2 |
| Daily Fishing Logbook (DFL) | 4-2 |
| Electronic Logbooks (ELB) | 4-2 |
| Verifying Fishing Effort Information | 4-3 |
| Logbook Requirements for Vessels Under 60ft. | 4-5 |
| Observer Estimates of Catch Weight | 4-6 |
| Weighed (“W”) Observer Estimates | 4-7 |
| Items too large for the Flow Scale | 4-8 |
| Volumetric Observer Estimates | 4-8 |
| Observer Estimates by Bin (“B”) Volumes | 4-9 |
| Observer Estimates by Codend (“C”) Volume | 4-9 |
| Determining Density | 4-11 |
| Ripped Nets, Dumping Codends, and Codend Lost | 4-14 |
| Catch Estimates on GOA Non-Pollock Trawl Catcher Vessels | 4-15 |
| Discard Estimates | 4-15 |
| Recording VHF and OHF Data | 4-16 |
| Completing Haul Forms on Trawl Vessels | 4-16 |
| Determining Offload Delivery Weight | 4-21 |
| Obtaining Your Fish Ticket | 4-21 |
| GOA Pollock CV Delivery Weight Instructions | 4-21 |
| Fish Retained for Bait and Personal Use | 4-22 |
| Prohibited Species Discarded at Sea on Pollock Catcher Vessels | 4-23 |
| Recording Offload Data on Trawlers | 4-23 |
| Catcher Vessels Delivering to Tender Vessels | 4-23 |
| Trawl Catch Form Examples | 4-25 |

PRIORITIES

- Your safety!
- Verify and record fishing effort information.
- Obtain independent estimates of catch for at least every haul sampled for species composition when required.
- Send data to the Observer Program as directed (see Sending Data on page 2-39).
- Collect the “goldenrod” copies of the vessel logbook pages or the electronic logbook printouts (if vessel is ≥60 ft).

SAFETY ONBOARD TRAWLERS

It is always your highest priority to stay safe and be aware of your surroundings aboard every vessel. Each vessel is

different and fishing situations are constantly changing. There are several concerns specific to trawlers you should be aware of to help ensure your safety.

When sampling on catcher trawlers, you may be working outside and exposed to the elements for long periods of time. In the winter months, you could experience freezing conditions, snow, spray, and high winds. Dress appropriately!

Decks can become very icy, making the process of transferring sampled catch from the collection point to weighing station very dangerous. Reduce the amount of fish you put in each container to make the load lighter, ask crew to assist you in transferring the sample, or push/pull the containers of sample along the deck. In rough weather, waves can break over the stern ramp and temporarily flood the trawl deck. Be aware of this possibility when you are out on deck and when

determining where to work up your sample. Choose sheltered areas to work if you can.

The Observer Program expects you to be proactive about your own safety by wearing a personal flotation device when ever you are working on deck, even if you think your sample station is not openly exposed to the elements. You should always notify the captain or crew if you plan to be, or think you will be, out on deck alone.

While on the trawl deck, observers often work close to tight cables and trawl wires because deck space is at such a premium. If you have to work around vessel gear and tight cables, make sure to communicate with the captain about what times are the best for you to be working in those areas. Often, the captain will ask that you wait for the crew to complete the setting or retrieval of gear before going on deck or to your work area. Requests or suggestions made by the captain pertaining to your safety or safe practices should be listened to, considered, and followed when appropriate!

On catcher processors, sampling is typically accomplished below decks, so weather is less of a contributing factor to one's immediate safety. Factories typically have sharp processing machinery, belt catch points, and hydraulically operated hatches that pose a significant hazard. There are many instances where crew have lost fingers, hands, arms, feet, or legs from getting caught by pinch points, hatch doors, or in machinery. Pay attention to the warning signs posted around factory machinery. *Never try to retrieve items that may have become entangled or stuck in the machinery by yourself!* Let the vessel's crew know about the problem, as there are strict lockout/tag out procedures to ensure that whenever machinery is being worked on or cleaned, it is turned off and locked in the "off" position.



Regardless of what vessel type you are on, your continued safety comes down to recognizing the dangers of the environment you are in. Don't become complacent!

DOCUMENTING FISHING EFFORT

This chapter covers the collection of fishing information for trawl vessels and for motherships (taking unsorted codend deliveries).

If your vessel is acting as a mothership, please also refer to Mothership Data Collection on page 6-1. *If the vessel acts as a tender only and does not fish for itself record*

non-fishing day positions only. If there is an observer on the vessel delivering to the mothership, they are responsible for recording catch effort data on their haul forms and for acquiring fish ticket information for the transferred catch.

Logbook Requirements for Vessels 60ft or Greater

All vessels greater than or equal to 60 feet in length overall are required by federal regulation to maintain a current NMFS "Alaska Groundfish" Daily Fishing Logbook (DFL) or use an Electronic Logbook (ELB). The captain or an assigned crew member must enter details of fishing activities, effort, and catch in the logbook. You will use the logbook to gather the information for the Vessel Haul Form (VHF) and Observer Haul Form (OHF). Observers have the right to inspect and copy the NMFS logbook and all other documentation of fishing effort under regulations found in 50 CFR § 679.51(e).

Daily Fishing Logbook (DFL)

Catcher vessels greater than or equal to 60 feet in length can use either a "paper" Daily Fishing Logbook (DFL) or an Electronic Logbook (ELB). See Figure 4-1 on page 4-4 for an example of a DFL paper "Goldenrod" page. Observers must collect copies of the DFL pages labeled "Goldenrod Observer copy".

Electronic Logbooks (ELB)

Some catcher vessels will use an electronic logbook (ELB); however, by regulation, all catcher processors and motherships with flow scales must use an ELB. This software captures the same information as the paper versions and is sent to the Alaska Regional Office electronically daily. If your vessel is using an ELB, you must bring back signed copies of the Daily ELB Report printouts, including the ELB Trip Report pages for non-fishing days, in place of "Goldenrod" copies. Request a signed copy of all revisions made to the ELB. Examples of the Daily ELB printout and the ELB Trip Report printout are shown in Figure 4-3 on page 4-5.

For the VHF you need to obtain the following information from the vessel logbook:

- Haul numbers. *If you are unable to make haul numbers match the ELB, contact your in-season advisor.*
- Type of trawl gear used.
- If the haul was CDQ and the CDQ group number.

- Date and time of gear deployment.
- Latitude and longitude of gear deployment.
- Average bottom depth and average gear depth.
- Date and time of gear retrieval.
- Latitude and longitude of gear retrieval.

In addition, you need to record a code corresponding to gear performance. Gear performance information is not recorded in the vessel logbook. Ask the captain to tell you if there were any problems during the tow or to document this information somewhere for you.

For the OHF you need to obtain the vessel's estimate of total catch weight. Check for updates to the vessel estimate after the haul is weighed on the flow scale.



Be sure all the information you need to complete your VHF/OHF is recorded on your forms before disembarking the vessel!

Verifying Fishing Effort Information

Before recording anything from the vessel logbook onto your data forms, you must verify that the data reported are accurate.

- An observer can verify haul information by recording personal observations (i.e. writing down positions or times on the deck sheet) and comparing it to the electronic or paper log book.
- If an observer is recording the information directly from the electronic or vessel logbook, they need to spot check where the captain initially recorded the haul information to look for any transcription errors.

If you find that a vessel logbook entry is wrong, determine the correct information for your Haul Forms.

Document these instances in your logbook, and mention the discrepancy to the captain or person in charge of maintaining the logbook. Please refer your captain to the Alaska Regional Office if they have questions (see page A-61). Usually, the error will be corrected by the crew member, so you should check the logbook for these changes. It is important that you record the correct information on the Haul Forms, even if the logbook entry is never amended. In general, your Haul Forms will match the vessel logbook, with the possible exception of these corrections.

Date and Time of Gear Deployment and Retrieval

For every haul, record the time the trawl net enters the water in the 'time of gear deployment' field of the VHF. You must also record the time of gear retrieval for every haul. The time you document should represent when the *retrieval of trawl gear cables begins*. Ensure the crew lists the time the net enters the water and leaves fishing depth, not the times the net reaches fishing depth or is pulled on board. Let the officer in charge of the logbook know if incorrect times are listed. If incorrect data continues to be logged, consult NMFS for advice on how to record your haul data.

Times That Do Not Reflect True Fishing Duration

Sometimes a codend is retrieved from fishing depth and then reset to fishing depth without being dumped on deck. A captain may do this to check the contents of the net or to make a fast or tight turn of the vessel (bringing the net to the surface will prevent the doors from crossing during the turn). When this occurs, the net is not actively fishing; therefore, the start and stop times recorded in the vessel's logbook and on your Vessel Haul Form do not accurately reflect the proper duration of fishing effort. ***Not all turns affect fishing duration. If the vessel does a wide turn or makes a turn without hauling back, the net is most likely still fishing, and the haul duration is not affected.*** If you suspect the vessel may be running gear in a manner that is affecting the duration, or you are unsure, check with the wheelhouse. List all "fishing duration affected" tows on the VHF with code "9" in the gear performance column. This code provides a good indication of whether the duration is a reliable indicator of fishing time or not. In the comments section of the Vessel Haul Form, note the haul number, why the duration was affected, and an estimate of the fishing time lost (if possible). Ask the captain to note in the vessel logbook when the proper fishing duration is not the difference between the start and stop times listed.

Deployment and Retrieval Latitude and Longitude

Deployment and retrieval positions are read from a GPS navigation system in the wheelhouse. The deployment location recorded in the vessel logbook should be the ship's position where the trawl net enters the water. The retrieval position should be the location where the retrieval of the trawl gear cable begins. Seconds must be documented on the VHF only if they are recorded by the vessel. If no seconds are recorded, leave it blank.

TRAWLER CATCH DATA: DOCUMENTING FISHING EFFORT

Revised: 5/11/2018 COPY DISTRIBUTION: WHITE Vessel Copy - GOLDENROD Observer copy - BLUE Discard copy - YELLOW NMFS Copy - Remit OMB Control No. 0548-0213 Expiration Date: 05/31/2021

CATCHER VESSEL DFL GROUND FISH TRAWL GEAR

VESSEL NAME: **GN'R** OPERATOR NAME AND SIGNATURE: **Saul Hudson**

DATE (M-D-Y): **6/27/23** HOURS: **13**

ADDRESS: **2329** FEDERAL FISHERIES PERMIT NO.: **2319**

MANAGEMENT PROGRAM: **Research** **CDG** **Exempted** **AIP** **NOA** **100**

INACTIVE START END REASON

VEAR TYPE (circle one): Non-pelagic trawl Pelagic trawl

CREW SIZE: **4** FEDERAL REPORTING AREA: **54** TRAWL GEAR ONLY (circle one): COBLZ RKCSA

OBSERVER INFORMATION: OBSERVER NAME AND CRUISE #: **NORC WILSON 823062** OBSERVER NAME AND CRUISE #: **1**

| HAUL NO. | TIME OF GEAR DEPLOYMENT | BEGIN POSITION OF HAUL | | AVE. SEA DEPTH (feet) | AVE. GEAR DEPTH (feet) | DATE AND TIME OF GEAR RETRIEVAL | END POSITION OF HAUL | | TARGET SPECIES CODE | TOTAL HAUL WEIGHT (or mt.) |
|----------|-------------------------|------------------------|-------------|-----------------------|------------------------|---------------------------------|----------------------|-------------|---------------------|----------------------------|
| | | LATITUDE | LONGITUDE | | | | LATITUDE | LONGITUDE | | |
| 85 | 1308 | 56° 30.7 N | 170° 47.0 W | 65 | 54 | 1858 | 56° 39.3 N | 171° 15.9 W | 770 | 150,000 |
| 86 | 1956 | 56° 39.9 N | 171° 18.2 W | 65 | 54 | 2301 | 56° 37.4 N | 171° 09.0 W | 270 | 40,000 |
| 87 | 2347 | 56° 37.7 N | 171° 12.5 W | 65 | 54 | 0128 0115 | 56° 37.5 N | 171° 15.0 W | 270 | 50,000 |

For groundfish and Pacific herring, circle lbs. or nearest 0.001 mt. For Pacific halibut, Pacific salmon, king crab, and Tanner crab, record in numbers.

DISCARD POSITION: DATE, SPECIES CODE, PRODUCT CODE, BALANCE FORWARD, DAILY TOTAL, CUMULATIVE TOTAL SINCE LAST DELIVERY

COMMENTS: **NO DISCARDS**

INSTRUCTION FOR CHECK BOX: IF YOU HAVE MOVED THIS VESSEL PRIOR TO THIS HAUL PRIMARILY TO AVOID ENCOUNTERING CHINOOK SALMON BYCATCH, PLACE A CHECK IN THIS BOX.

DELIVERY: DELIVERY DATE: **6/28** ADF&G TICKET NO.: **E10973698** RECIPIENT'S NAME: **ALYESKA** ADF&G PROCESSOR CODE: **F0753**

Figure 4-1: Vessel Logbook Example

Do not enter “00” as this creates a defined position in geographical space which is incorrect.

If you notice significant changes between deployment and retrieval positions or between one haul position and the next, ask the captain if these distances are correct. Substantial changes in position are those more than two degrees of latitude or longitude on the same day or those more than six degrees of latitude or longitude over a two-day period. You should occasionally check during haul backs that the latitude and longitude listed in the logbook match that on the GPS display.

Vessel Estimates of Catch

The vessel operator must make their own estimate of the weight of the catch. This estimate is often referred to as a haul weight. By regulation, the catch weight must be entered into the vessel logbook within two hours of gear retrieval or within two hours of completion of weighing the catch if the vessel is required to weigh catch on an NMFS-approved scale. On these vessels, the scale weight must be entered for the vessel estimate. Be sure to check if the captain records a haul weight and later replaces it with the flow scale weight. During your first few days onboard, *ask the captain how they make their vessel estimates and document the response in your logbook.*

 **One degree of latitude is equal to sixty nautical miles. A vessel traveling at 10 knots for one hour will travel 10 nautical miles. Towing a net at a speed of 3.5 knots, it would take you 17 hours to travel one full degree! Keep this in mind when verifying haul data.**

The vessel operator may record this weight in either metric tons or pounds, *but you must record it in metric tons on your OHF. If you need to convert the logbook value from pounds to metric tons, show this calculation in your logbook in the Vessel Estimate Conversion Calculations section; see Figure 4-2.*

Vessel Estimate Conversion Calculations

Vessel Name: **GN'R**

| Haul Number | Vessel Estimate in Pounds | Multiplied by 0.4536 kgs/lb (conversion factor) | Equals Vessel Estimate in Kilograms | Rounded Vessel Estimate in MT (to nearest hundredth) |
|-------------|---------------------------|---|-------------------------------------|--|
| 85 | 150000 | x 0.4536 kgs/lb | 68040 | 68.04 |
| 86 | 40000 | x 0.4536 kgs/lb | 18144 | 18.14 |

Figure 4-2: Documenting Conversion Calculation of Vessel Haul Estimate in Pounds to Kilograms

The CP trawl vessel logbook instructions read that, in addition to the total catch weight estimate, the vessel operator must record a separate entry for catch estimates of species managed under the IR/IU regulations (see page 5-27). Ensure that the vessel operator’s documented *total estimate* of catch includes any IR/IU species caught.

| DAILY ELB REPORT | | | | | | | | | | Vessel Name VERA LYNN | | Trip Name A | | Report Date 02/21/2023 | | | |
|------------------|-----------|-------------------------|--|------------|----------------|-----------------|---------------------------|--|------------|---|--------------|--------------------------|---------|--------------------------------------|-------------------------------------|--------------|-----------------------------------|
| CP TRAWL GEAR | | | | | | | | | | Operator Name and Signature Nick Mason | | ADFG Vessel No. 71923 | | Federal Fisheries Permit No. 6102 | | | |
| Haul No. | Mgmt Form | Time of Gear Deployment | Begin Position of Haul Latitude Longitude | | Avg. Sea Depth | Avg. Gear Depth | Time of Gear Retrieval | End Position of Haul Latitude Longitude | | Federal Reporting Area | Special Area | Target Species Code | Gear ID | Gear Type | Total Haul Weight | Species Code | Wt. or No. |
| 51 | A80 HDS | 15:37 | 57 02.8 N | 162 51.0 W | 30 FM | 30 FM | 16:34 18:20 | 57 06.4 N | 162 48.0 W | 516 | | 127 | 7 | NPT | 1.9600 MT 1.9570 MF | 110 | 0.0090 MT 0.0160 MF |
| | | | | | | | | | | | | | | | 60 | 270 | 0.0000 MT |
| | | | | | | | | | | | | | | | 98 | 200 | 6.0000 |
| 52 | A80 HDS | 18:20 | 57 08.7 N | 162 52.7 W | 28 FM | 28 FM | 21:07 | 57 11.3 N | 162 33.8 W | 516 | | 127 | 7 | NPT | 34.1944 MT 34.1940 MF | 110 | 0.1490 MT 0.2020 MF |
| | | | | | | | | | | | | | | | 60 | 270 | 0.0000 MT |
| | | | | | | | | | | | | | | | 98 | 200 | 1.0000 |
| 53 | A80 HDS | 02/22 23:16 | 57 12.4 N | 162 32.0 W | 28 FM | 28 FM | 02/22 02:03 | 57 08.6 N | 162 51.9 W | 516 | | 127 | 7 | NPT | 32.4441 MT | 110 | 0.1410 MT |
| | | | | | | | | | | | | | | | 60 | 270 | 0.0000 MT |
| | | | | | | | | | | | | | | | 98 | 200 | 2.0000 |

COMMENTS:

| Flow Scale Test Time | Platform Scale Weight (kg) | Flow Scale Weight (kg) | Error | Percent Error | Observer Present | Comment |
|----------------------|----------------------------|------------------------|--------|---------------|------------------|---------|
| 14:05 | 435.20 | 399.40 | -35.80 | -8.23 | YES | |
| 14:10 | 478.72 | 446.40 | -32.32 | -6.75 | YES | |
| 14:15 | 435.40 | 397.60 | -37.80 | -8.68 | YES | |
| 14:25 | 435.60 | 445.10 | 9.50 | 2.18 | YES | |

Status: Receipt Received Transmission Time: 02/25/2023 06:51 Last update: 02/24/2023 08:57 VERA LYNN Page A-1

| ELB TRIP REPORT | | | | | | | | | | Vessel Name VERA LYNN | | Trip Name A | | Report Date 02/21/2023 | | |
|----------------------|-----------|-----------------------------------|-----------------------------------|-----------------------------------|-------------------------|--|--|--|--|---|--|--------------------------|--|--------------------------------------|--|--|
| | | | | | | | | | | Operator Name and Signature Nick Mason | | ADFG Vessel No. 71923 | | Federal Fisheries Permit No. 6102 | | |
| Gear ID | Gear Type | 7 Non-pelagic/bottom trawl | | | | | | | | | | | | | | |
| Trip Start Date | Crew Size | | | | | | | | | | | | | | | |
| 02/20/2023 | 38 | | | | | | | | | | | | | | | |
| OBSERVER INFORMATION | | Observer Name and Cruise Number # | Observer Name and Cruise Number # | Observer Name and Cruise Number # | No. of Observers Aboard | | | | | | | | | | | |
| | | Ann Wilson 29413 | Debbie Harry 29933 | | 2 | | | | | | | | | | | |
| ACTIVITY | | ACTIVITY DATE | | | REASON | | | | | | | | | | | |
| Go Inactive | | 02/20/2023 | | | Automatic checkout | | | | | | | | | | | |
| Go Active | | 02/21/2023 | | | | | | | | | | | | | | |
| Go Inactive | | 02/28/2023 | | | Offload | | | | | | | | | | | |

Status: Receipt Received Transmission Time: 03/01/2023 06:51 Last update: 02/28/2023 08:57 VERA LYNN Page A-0

Figure 4-3: Daily ELB Report and ELB Trip Report

Logbook Requirements for Vessels Under 60ft

Vessels less than 60 feet are not required to use an NMFS logbook. Vessels that are not required to complete an NMFS logbook must still cooperate with the observer to provide you with required catch data. You will need to obtain haul data to complete all fields on the VHF form just as you would on a vessel with a logbook. The captain may not be familiar with what information you need. It is critical that you clearly communicate and inform the captain of your needs so that they can assist you with obtaining accurate and timely information. This discussion should occur immediately upon embarking on the vessel. You may need to alter your request for information during your trip as you gain experience with the data.

Alternative Methods for Keeping Haul Data

The captain may have an alternative method of logging catch information such, as a personal notebook unofficial logbook, or may track and record haul data on the plotter.

Regardless of what your vessel is using to document its fishing effort, you are required to obtain all basic haul information and report it on the Vessel and Observer Haul Forms. If the data you are collecting deviates in any way from the definitions listed in the Observer Sampling Manual, you must document this information in your daily notes. As with all catch information, this data is expected to be verified on a daily or haul-by-haul basis during a trip to ensure accuracy.

TRAWLER CATCH DATA: OBSERVER ESTIMATES OF CATCH WEIGHT

To facilitate easy data sharing, you must provide the captain with the “Fishing Effort Summary for Trawl Vessels” form (see Figure 4-5 on 4-7). This form is preformatted to make it simple for the captain to provide the data you need to complete your work. This summary form is not a regulatory form (and thus not required), but observers will use it to perform their required duties. The captain may fill out all, some, or none of this form. However, if they do not fill it out, they should be informed that you will be required to collect this information through other means.

Haul data should be recorded directly onto the haul forms from a logbook when possible. Haul information may be collected in another manner, such as Fishing Effort Summary, written on a post-it note, or a notebook page. This raw data should be retained and returned with you for debriefing (if possible). Vessels under 60ft are not required to provide copies of their personal notes of haul data. Document in your daily notes if the original data is recorded straight onto the haul forms and copies of raw data were unavailable.

If the vessel’s captain cannot provide you with the needed information, you will be expected to collect haul data independently, either to verify provided haul information or to document fishing effort data. This may prove to be difficult and time-consuming. You may need to adjust your other duties to adapt to the additional time required to collect catch information. Document this in your daily notes to ensure you meet program expectations. Contact Observer Program staff as soon as possible for assistance.

| | | | |
|---------|----------------|---------------------------|-------------|
| 3-30 pm | | | |
| Set | 9:10 pm | #1 - 55°45.03 / 154°2.28 | 105 Lth |
| Haul | 2:40 AM (3-31) | 55°48.83 / 154°09.38 | net @ 75F |
| | | | 10,000 lbs |
| 3-31 | | | |
| Set | 4:30 AM | #2 - 55°49.15 / 154°08.99 | 102 Lth |
| Haul | 10:30 AM | 55°48.2 / 154°09.5 | net @ 77F |
| | | | 125,000 lbs |

Figure 4-4: Haul Data Recorded on <60 ft Vessel

When You are Not Able to Obtain Haul Data

If you are unable to obtain catch effort information, inform Observer Program staff immediately at the first opportunity. Document any communications with the vessel and any attempts that you made to collect haul data.

OBSERVER ESTIMATES OF CATCH WEIGHT

Independent observer estimates of catch weight are made on most trawlers. The exception is pollock catcher trawlers delivering to a processing plant or floating processor, where an independent observer estimate is not required.

Observer estimates of catch weight must be *unbiased and made independently*. You must make estimates for as many hauls as possible. There are three methods for determining total catch weight:

1. Weighed (“W”) estimate - entire catch is weighed using the observer scales or using the vessel’s flow scale.
2. Bin (“B”) estimate - weight is calculated using a bin volume and density.
3. Codend (“C”) estimate - weight is calculated using a codend volume and density.
4. You can use any of these three methods on a vessel, depending upon catch size, composition, and vessel configuration. Observer estimate methods are indicated by the letters “B,” “C,” or “W” in the “B, C, or W” column on the OHF (see Completing the OHF on Trawl Vessels on page 4-19).

Large Items

Occasionally marine mammals (or parts of marine mammals) or large inorganic items (such as a boulder or 55-gallon drum) are caught by trawlers. To prevent the weight of mammals or other large objects from being misinterpreted by management as fish weight, do not include the weight of the item in the Observer Estimate. If you are making a codend or bin volume estimate, subtract the volume of the large item from your calculated volume of the codend or bin.

Fishing Effort Summary for Trawl Vessels Page _____ of _____

The information collected on this form is intended to be utilized only by the assigned observer to complete their required data collections.

Vessel Name _____ Vessel ADF&G number _____

| Haul No. | CDQ # | Deployment Information | | | | | Average bottom depth <small>M or FMT circle one</small> | Average gear Depth* <small>M or FMT circle one</small> | Retrieval Information | | | | | Catch estimate <small>Lb or MT circle one</small> | Gear problem? <input type="checkbox"/> | |
|----------|-------|------------------------|-----|------------|--------------|-----------|--|---|-----------------------|-----|------------|--------------|-----------|--|---|--|
| | | Month | Day | Time (ALT) | Latitude (N) | Longitude | | | Month | Day | Time (ALT) | Latitude (N) | Longitude | | | |
| | | | | | | | | | | | | | | | | |
| | | | | | | | | | | | | | | | | |
| | | | | | | | | | | | | | | | | |
| | | | | | | | | | | | | | | | | |
| | | | | | | | | | | | | | | | | |
| | | | | | | | | | | | | | | | | |
| | | | | | | | | | | | | | | | | |
| | | | | | | | | | | | | | | | | |
| | | | | | | | | | | | | | | | | |
| | | | | | | | | | | | | | | | | |
| | | | | | | | | | | | | | | | | |
| | | | | | | | | | | | | | | | | |
| | | | | | | | | | | | | | | | | |
| | | | | | | | | | | | | | | | | |
| | | | | | | | | | | | | | | | | |
| | | | | | | | | | | | | | | | | |
| | | | | | | | | | | | | | | | | |

Definitions:

Deployment date/time/position: When the trawl net or first enters the water **Catch Estimate:** Visual estimate of total catch including bycatch in lbs or kgs

Retrieval date/time/position: When the trawl net leaves fishing depth **Gear Problem ?:** Was there any issues with gear if so check the box

CDQ: Indicate CDQ with the CDQ number otherwise, leave blank

Updated 11/8/2012

Figure 4-5: Fishing Effort Summary for Trawl Vessels (Optional for Vessel Operators)

Weighed (“W”) Observer Estimates

Independent weighed estimates are obtained using either: 1) NMFS issued observer scales, 2) a motion compensated platform (MCP) scale, or 3) a certified motion compensated flow scale.

To be used for catch weight estimates, flow scales and motion compensated platform scales must pass daily tests for accuracy.

For small hauls under about 500 kilograms, you could feasibly use your observer scales or MCP scale to weigh the entire catch. For larger hauls, weighed estimates will be obtained using a certified flow scale.



The Flow Scale Catch Estimate Calculation pages in the Observer Logbook must be completed when you are using the flow scale to obtain weighed observer estimates.

Motion compensated flow scales record the weight of catch as it runs over the scale. If you are going to use

the flow scale for the observer estimate, the crew must test the scale every 24 hours. You may use the flow scale for deriving an observer estimate only if it has been tested for that day, has passed the test, and the test was witnessed by an observer. For more information on flow scales, see Flow Scale Testing on page 2-31.

When using the vessel’s flow scale to obtain an observer estimate, all organisms that are not weighed over the flow scale, including all pre-sorted organisms and organisms too large to go over the flow scale, must be added to the flow scale value.

If the Flow Scale is Not Working

If you are on a CP or mothership vessel that is required to use a flow scale, *you never measure the codend to obtain an observer estimate of catch.* This holds true even if the flow scale is broken, has faulted (i.e., not weighed a portion of catch), or has failed the daily test. If the flow scale is not working, leave the observer estimate blank, and make sure to enter a vessel estimate value in the vessel estimate field for that haul!

If the vessel has questions about flow scale requirements, refer them to Melanie Rickett of the Alaska Regional

Office at (206) 526-4070. Do not refuse to sample or tell the vessel they can't fish if the flow scale or platform scale is not functioning (see page 2-32). Simply inform your inseason advisor of the situation and NMFS will take any necessary action.

Items too large for the Flow Scale

The weight of organisms other than marine mammals that are too large to enter the live tanks and go over the flow scale must be added to the flow scale weight and included in the observer estimate.

Even though vessels are required to weigh all catch, there are certain fish (e.g., sharks, halibut, etc.) that are too large to go over a flow scale or may not enter the tank due to the deck excluder bars. To account for these large items do the following:

1. If possible, obtain an actual weight using the MCP, and add this weight to the flow scale weight.
2. Large halibut weights not weighed on the MCP, should be estimated with the help of vessel crew.
3. If the organism is too large to weigh on the observer scales, measure the item and use the appropriate length weight table to obtain the weight if a length weight table is available.
4. If a length weight table does not exist for that species, measure the item, estimate the weight, and add that estimate to the final flow scale weight for the haul.
5. If the item not weighed falls under the category of "pre-sorted," it must be accounted for as a unique sample (see Accounting for Pre-Sorted Samples on page 5-22).
6. Inform the captain that the large item was not weighed by the flow scale to allow the vessel to update the Vessel Catch Estimate in the ELB.
7. Document instances when the Observer Catch Estimate is greater than the Vessel Catch Estimate for the haul in your logbook.

Volumetric Observer Estimates

The way the catch is handled on a vessel will help you determine which catch estimation method is most applicable. Calculations for observer estimates require both a volume and a density value for the catch. On catcher vessels, the codend may be emptied directly onto

the trawl deck for sorting, or into below-deck refrigerated seawater (RSW) tanks. Observers often find that estimates by codend are the most feasible in these cases. Estimates by bin volume may work equally well if catch is dumped into the trawl alley. On catcher processors that are not required to use a flow scale, the catch is often held in the codend before being dumped into a tank or bin. In these instances, volumetric estimates can be determined for the filled codend, or the filled bin.

On some vessels, codends are brought up in portions and dumped incrementally onto the deck or into tanks. Obtaining weight estimates in these situations can be challenging. If making codend estimates, try to mark the bag with string or other material so you don't measure and account for an area twice. Work with the crew to see if they can assist you in measuring and keeping track of codend sections. If the crew are dumping catch incrementally into bins, ask if they can completely empty the bin before adding more catch from the codend.

Consider the areas where fish will be held before processing and delivery: the codend, trawl alley, checker bins and/or live tanks. Determine which container will be safest to measure, and the easiest to accurately measure.

To calculate the observer estimate, multiply total volume of catch by a density factor (see Determining Density on page 4-11). The volume, density, and the observer estimate are recorded on the Observer Haul Form.

Record the measurements you take for each haul on your Deck Form. All dimensions, calculations, and methods must be noted in your logbook in the Volumetric Catch Estimate Calculations section. You must document and explain your estimation methods in the Daily Notes pages. When making volumetric estimates of the total catch, keep the following in mind:

- You do not make volumetric estimates on CPs or motherships that are required to use a certified, tested motion compensated flow scale, regardless of whether the flow scale has passed the daily test. (Amendment 80 vessels in the flatfish fishery operating in the Gulf of Alaska may be exempt from using their flow scale. Consult with NMFS staff before embarking on these vessels.)
- On catcher vessels, make volumetric estimates of checker bins, trawl alleys, codends or codend sections.
- The formula for determining catch weight using volume and density is:

$$\text{volume (m}^3\text{)} \times \text{density (kg/m}^3\text{)} = \text{catch weight (kg)}$$

- Record your total catch weight estimates on the OHF, even if you are not totally confident about the accuracy of the estimate.
- If you find that none of the methods suggested will provide an accurate independent catch estimate, contact NMFS staff as soon as possible for assistance.



Observer estimates cannot be made by guessing the weight of the catch or by using numbers provided by the crew. They must be calculated using actual measurements taken by you.

Observer Estimates by Bin (“B”) Volumes

The steps in making a volumetric estimate of live tanks, trawl alleys, or checker bins are:

1. **Measure the area of the empty bin.** Many fish bins and tanks are irregularly shaped and need to be measured as several independent sections. To do this, sketch out the bin and visually break up the floor area into regularly shaped sections that can be measured easily. Figure 4-6 on page 4-10, shows how an unusually shaped trawl alley was divided and measured to calculate a floor area.
2. **Determine the appropriate formulas for each area of the bin.** Consult Abbreviations, Conversions, and Formulas on page A-19 and select the appropriate volumetric formula for each separate shape. Each mathematical formula identifies what dimensions are measured (length, width, height, short radius, diameter, etc.). The sum of the areas for all the sections yields the total area of the bin.
3. **Measure the height of catch in the bin.** The height of the fish in the bin provides the final dimension needed to obtain the volume of the catch. If you are using a fish bin, there may be permanent marks that you can use for a depth measurement. Be sure to verify the accuracy of these marks before you rely on them for your own measurements. If the bin is unmarked, ask permission to mark the bin with height markers. The vessel crew may be able to provide you with paint or other permanent writing material. Replace marks as they erode over time. The bin or tank should be

marked on all four sides and all markings should be visible. Marks should be in increments of no more than 10 cm. On some vessels, you can use a stick marked in centimeter increments to measure the depth of fish in the bin or trawl alley.

4. **Calculate and record bin volume and catch weight.** Record height measurements on your Deck Form and record all area and volume calculations in your logbook. When you take multiple measurements for one dimension (e.g., height) use an average in your final volume calculation. Make sure that all of your measurements are as precise as possible and describe your methods in your logbook.

Potential Bin Volume Biases

The following are factors that may affect the accuracy of your bin volumetric estimates:

- tanks may be enclosed such that the depth of fish cannot be determined;
- tanks may hold fish and an indeterminate amount of water;
- tanks may be too difficult to measure because of many irregular shapes;
- level of fish may be too shallow to obtain an accurate reading.

If you notice any of the potential biases listed, observer estimates by codend volume would be a better alternative. Document all methods used for obtaining independent observer estimates in your logbook. Be sure to include descriptions of any problems you encountered.

Observer Estimates by Codend (“C”) Volume

Always remember that safety is your first concern when measuring a codend. Codends tend to slide and roll. Never enter the trawl alley to take measurements. Ask crew members for assistance; their help will make the task easier and safer. Follow the steps listed below to take an accurate codend measurement.

1. **Determine the appropriate geometric shape(s):** Decide on the appropriate formula(s) to use based on the shape of the codend. Using the formula, determine which dimensions you need to measure in order to obtain a volume. Refer to page A-19 for the formulas required to calculate volumes of various shapes.

2. **Measure sections of the codend using actual measurements and/or reference points:**

A minimum of three height measurements and three width measurements should be taken for each length section. If this is not possible document the reasons why. Multiple measurements are preferred as the height and width may change as you go along the entire length of the codend. If this is not possible document the reasons why. The preferred method to obtain height measurements is to use your tape measure. Another option is to use a long stick, or similar item, and mark it in centimeters for use as a height gauge. When sighting across the net for a height, your eyes should be level with the top of the net. If the net is large, moving around dangerously, or brought aboard in segments, using pre-measured areas of the deck is a safer alternative for measuring codends.

- Measure the length of the trawl alley. Use reference points or place marks in 1/10 of a meter increments along the trawl alley wall to determine the codend length. If the net outline does not line up with your

pre-measured deck markings, you must determine the difference in distance between any marks and where the codend ends.

- Measure the width of the entire trawl alley. If the codend does not fill the entire alley, measure the distance between the codend and the trawl alley walls. This can be done using a tape measure or by pre-measuring a stick. Subtract this measurement from the total trawl alley width to determine codend width.

3. **Record dimensions, calculations, and volumetric formula:** In your logbook, record the methods, dimensions and calculations used in obtaining your volumetric estimates. Record the calculated volume in cubic meters. Document all calculations used to obtain the total catch weights in kilograms, including density calculations when appropriate.

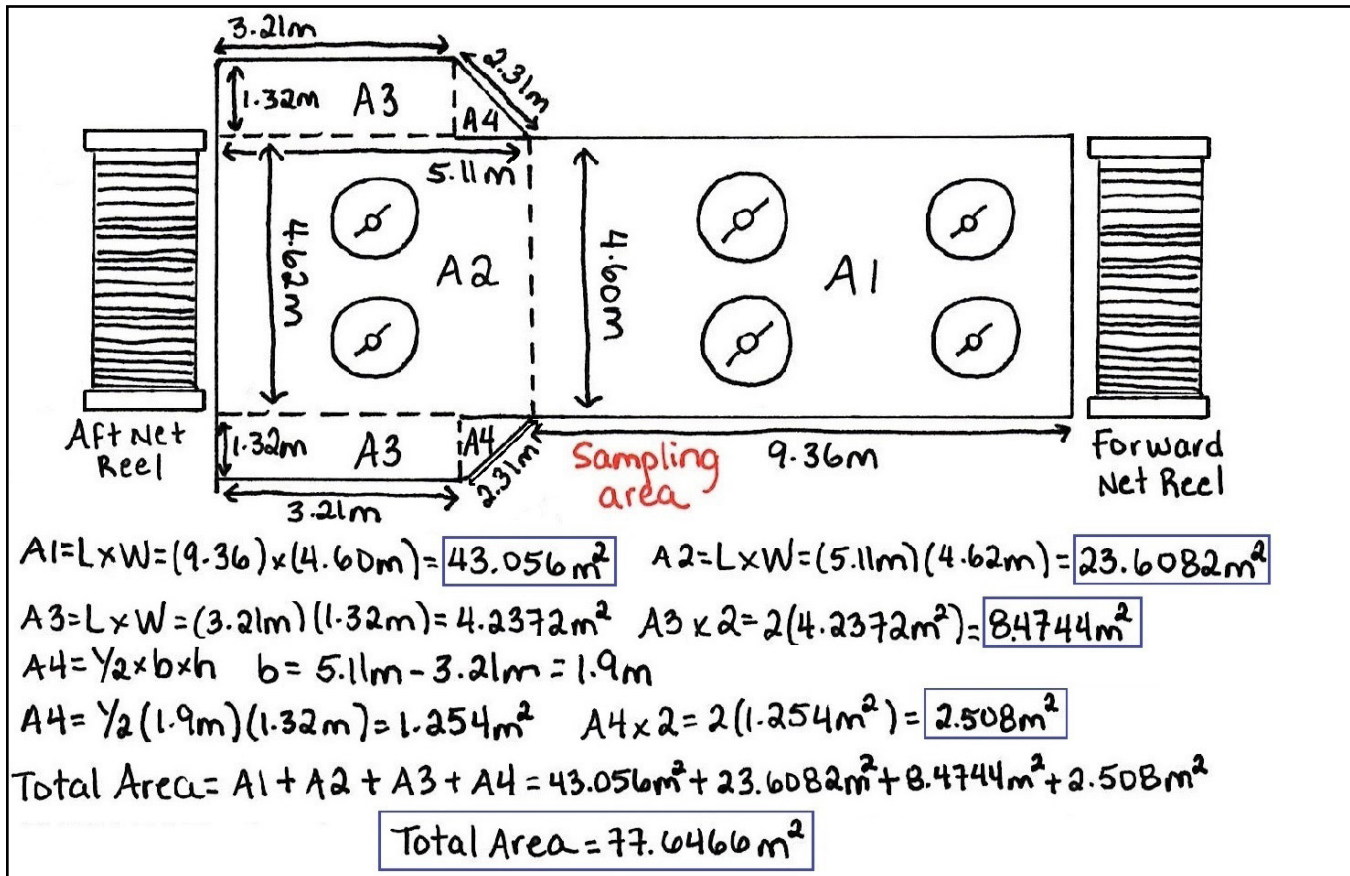

Figure 4-6: Calculating Area of an Irregular Shaped Trawl Alley



Occasionally, large items like boulders are caught. Do not include these items in your estimates of catch. If the item is in the codend, calculate the volume of the item and subtract it from your codend volume.

Measuring Large Codends

Codends can sometimes be longer than the trawl deck. These codends must be emptied in several sections. To determine the codend volume in this situation, measure each codend section as it is brought on board. Use the reinforcing cables or “expansion straps” around the circumference of the filled codend to visually divide it into sections. Determine a volume for each segment of the net and add these together for a total volume. *Each section must be independently measured! Do not apply a predetermined or constant volume to the number of codend segments (see Figure 4-8 on page 4-12 and Figure 4-9 on page 4-13 for an example of the expected level of documentation).*

Determining Density

Once you have obtained a volumetric estimate of the catch, you must calculate the weight of the catch. To do this, you need to multiply the catch volume by a density. Density should be expressed in kilograms per cubic meter. Multiply the density by a codend or bin volume to calculate the catch weight estimate. Densities are either prescribed, or calculated.

Prescribed Densities

If the catch consists of *50% or more pollock*, apply a density of 980.00 kg/m³ when using bin volume, or a density of 1020.00 kg/m³ when using codend volume.

Calculated Densities

- If you are calculating density, *you must take a density sample whenever there are significant changes in species composition between hauls.*
- Densities must be taken from unsorted catch. Settle or arrange fish to minimize interstitial spaces. Measure the containers you use for density carefully!
- If catch composition is relatively constant between hauls, *you must take density samples at least once within each 24 hour period.*

To calculate density, measure both the volume and weight of an unsorted sample of catch. Choose a container

that holds 500 kg or less and has a volume that can be calculated. Oil drums or plastic garbage cans hold about 300 kg and are excellent density containers. A plastic tote, filled part way, is also excellent for calculating density estimates. As a last resort, use four or more observer baskets for the density sample. Refer to Figure 4-8 when using the Observer Program’s standard observer basket to obtain density estimates.

To calculate density:

1. Determine the volume of your container by measuring it using the same methods you would to measure the volume of fish in a bin.
- If you are using Observer Program issued observer baskets, you must fill them with unsorted catch to the level indicated for each basket type and use the volume shown for each basket type in Figure 4-7.

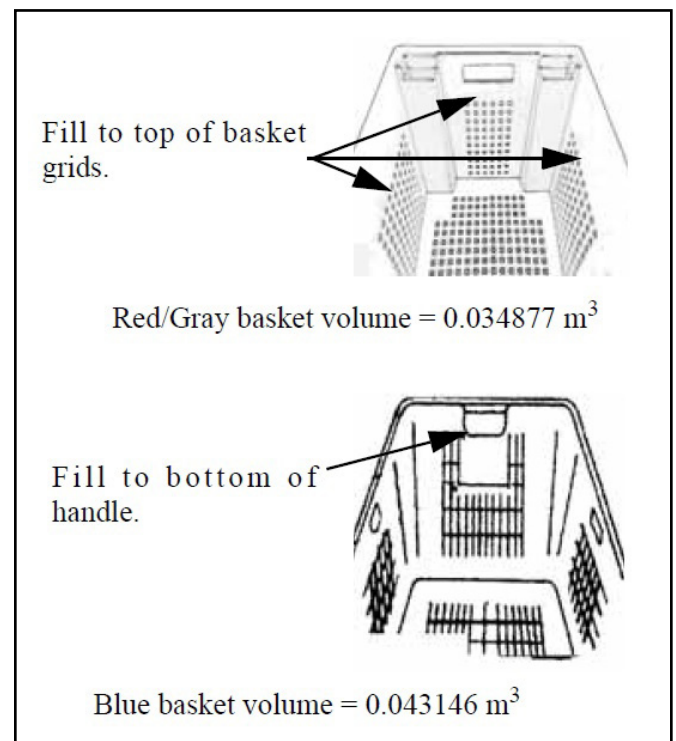

Figure 4-7: Basket Volumes

- If you are using a garbage can take note of its shape. Most garbage cans are not cylindrical as they tend to narrow towards the bottom. If this is the case be sure to use the formula for the frustum of a right circular cone with the appropriate measurements. Also take note of the lip of the garbage can. Is it significantly wider

TRAWLER CATCH DATA: OBSERVER ESTIMATES OF CATCH WEIGHT

| DECK FORM | | | | | Page <u>5</u> of _____ for Vessel/Plant | |
|---------------------------------|-------------------------------------|--------------------------------|----------|-------------------------------------|--|---|
| Date | Cruise | Permit | Haul No. | Offload No. | Page <u>1</u> of _____ for Haul/Offload | |
| 09/18/23 | 24680 | 7691 | 99 | | | |
| Sample #: | | Sub-Sample #: | | Sample Size: | | # of Sampled Hooks: |
| Presorted <input type="radio"/> | | Combined <input type="radio"/> | | | | No Fish in Sample <input type="radio"/> |
| Species | Sex | # | Weight | % ret. | <p>Length, viability, injury, specimen, tally data, measurements, bird observations, sample design, notes:</p> <p>Codend Volume</p> <p><u>Section 1 -</u></p>  <p><u>Section 2 -</u></p>  | |
| ----- KEYPUNCH ----- | <input checked="" type="checkbox"/> | | | <input checked="" type="checkbox"/> | | |
| | | | | | | |
| | | | | | | |
| | | | | | | |
| | | | | | | |
| | | | | | | |
| | | | | | | |
| | | | | | | |
| | | | | | | |
| | | | | | Tally K/P | |
| Sample #: | | Sub-Sample #: | | Sample Size: | | # of Sampled Hooks: |
| Presorted <input type="radio"/> | | Combined <input type="radio"/> | | | | No Fish in Sample <input type="radio"/> |
| Species | Sex | # | Weight | % ret. | <p>Length, viability, injury, specimen, tally data, measurements, bird observations, sample design, notes:</p> <p>Density Baskets (Red Baskets)</p> <p>B₁ = 32.06 From Sample 1</p> <p>B₂ = 31.85</p> <p>B₃ = 33.20</p> <p>B₄ = 31.45</p> | |
| ----- KEYPUNCH ----- | <input checked="" type="checkbox"/> | | | <input checked="" type="checkbox"/> | | |
| | | | | | | |
| | | | | | | |
| | | | | | | |
| | | | | | | |
| | | | | | | |
| | | | | | | |
| | | | | | | |
| | | | | | | |
| | | | | | Tally K/P | |

Figure 4-8: Measuring Large Codends (example of expected level of documentation of raw data in Deck Sheet)

Volumetric Catch Estimate Calculations

VESSEL NAME Echoes

| | |
|---|--|
| <p>HAUL No. <u>99</u> Total catch weight (kgs) <u>35611</u></p> | <p>Volumetric Calculations (show all your work!). $\pi = 3.1416$ Circle the shape(s) that apply and document equations used.  Other</p> |
| <p>Density Calculations container(s) used: <u>4 red baskets</u> $D = \text{mass} / \text{Volume}$ Basket weights: <u>32.06 kg + 31.85 kg</u> <u>33.20 kg + 31.45 kg</u> <u>MΣ = 128.56 kg</u> Volume red basket $= 0.034877 \text{ m}^3 \times 4$ $V = 0.139508 \text{ m}^3$ $D = \frac{128.56 \text{ kg}}{0.139508 \text{ m}^3}$ $D = 921.5242136 \text{ kg/m}^3$</p> | <p><u>Volume Section - 1 (Ellipsoid)</u> $\bar{H} = 1.5 \text{ m} + 1.9 \text{ m} + 1.7 \text{ m} = 5.1 \text{ m} / 3 = 1.7 \text{ m} = \bar{H}$ $\bar{W} = 3.2 \text{ m} + 3.4 \text{ m} + 3.3 \text{ m} = 9.9 \text{ m} / 3 = 3.3 \text{ m} = \bar{W}$ $L = 4.25 \text{ m}$ $V_1 = \pi (\frac{1}{2} H) (\frac{1}{2} W) L$ $V_1 = \pi (\frac{1}{2})(1.7 \text{ m})(\frac{1}{2})(3.3 \text{ m}) 4.25 \text{ m}$ $V_1 = \pi (0.85 \text{ m})(1.65 \text{ m}) 4.25 \text{ m}$ $V_1 = 18.7258995 \text{ m}^3$ <u>Volume Section - 2 (Ellipsoid)</u> $\bar{H} = 1.25 \text{ m} + 1.5 \text{ m} + 1.6 \text{ m} = 4.35 \text{ m} / 3 = 1.45 \text{ m} = \bar{H}$ $\bar{W} = 3.1 \text{ m} + 3.4 \text{ m} + 3.4 \text{ m} = 9.9 \text{ m} / 3 = 3.3 \text{ m} = \bar{W}$ $L = 5.3 \text{ m}$ $V_2 = \pi (\frac{1}{2} H) (\frac{1}{2} W) L$</p> |
| <p>HAUL No. _____ Total catch weight (kgs) _____ Density Calculations container(s) used: _____</p> | <p>Volumetric Calculations (show all your work!). Circle the shape(s) that apply and document equations used.  Other</p> <p>$V_2 = \pi (\frac{1}{2})(1.45 \text{ m})(\frac{1}{2})(3.3 \text{ m}) 5.3 \text{ m}$ $V_2 = \pi (0.725 \text{ m})(1.65 \text{ m}) 5.3 \text{ m}$ $V_2 = 19.9181367 \text{ m}^3$ $V_{\text{Total}} = V_1 + V_2 = 18.7258995 \text{ m}^3 + 19.9181367 \text{ m}^3$ $V = 38.6440362 \text{ m}^3$ Total Catch = $V \times D$ $= 38.6440362 \text{ m}^3 \times 921.5242136 \text{ kg/m}^3$ Total Catch = <u>35611.41506 kg</u> Total Catch = <u>35611 kg</u></p> |

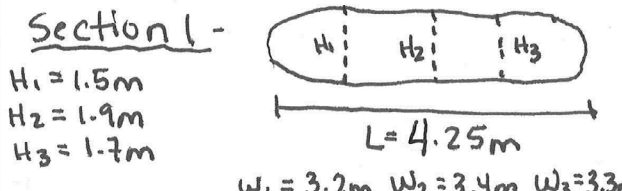
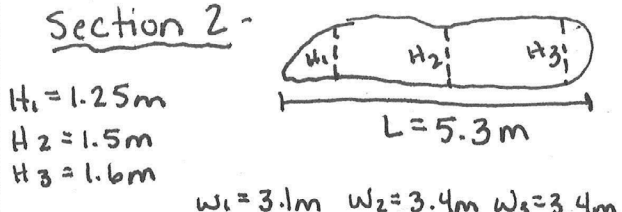
Figure 4-9: Measuring Large Codends (example of expected level of documentation)

at the top then abruptly narrows? If so, you have two options: fill up the garbage can to the bottom of the lip or calculate the two different volumes.

2. Fill the container with randomly selected unsorted catch. In many instances it is easiest to use your species composition sample. Settle or arrange the fish to minimize interstitial space.
3. Fill your containers consistently to the same level or measure the height of the catch in your containers. Record the height value on your Deck Form. If you are using your observer baskets for density, be sure to fill them to the level shown in Figure 4-9. This level corresponds with the standard volume given in Figure 4-9.

Some vessels have blue baskets made by another company. These are smaller than Observer Program issued baskets and should not be used to determine densities!

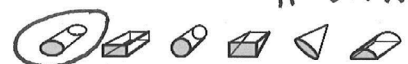
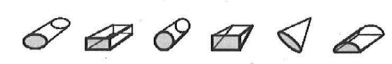
4. When unsorted catch is spilled or dumped into a large area that will not work for a container, a proven sampling method is as follows:
 - Number the corners of the area, and randomly select one.
 - Remove the catch that are closest to the corner and place them in your baskets.
 - Work outward from the corner in an outward fan-shaped manner until all four baskets are filled to the prescribed level or
 - Work in a clockwise or counterclockwise direction from the corner removing fish until all four baskets are filled to the prescribed level. If using this method (or one similar), as you move across your bin have a predetermined width as a guide to the path to remove fish from (i.e. width of a shovel, basket, several bin boards).
 - You must remove the catch in a repeatable, unbiased manner with all unsorted fish being placed in the baskets if they are within the collection area.
- Fill each basket to the prescribed level, before beginning to fill the next basket.
- Be sure to include everything from the catch including but not limited to, fish, invertebrates, garbage, etc. Be sure to clear the area down to the deck/bottom of the

bin when removing fish for your density.

5. When unsorted catch is collected and contained in your baskets, a proven sampling method is as follows:
 - Randomly select at least four baskets of unsorted catch.
 - If the baskets are not filled to the prescribed height, you may need to remove or add fish to get the basket to the proper level. If so, this should be done in an unbiased manner. Common methods include but are not limited to:
 - Pick a random corner, remove fish closest to the corner, and work out in a fan-shaped manner to remove fish.
 - If fish must be added, follow the same process to take fish from a non-selected basket to add fish to your density basket.
6. The target weight for density is 200 Kg. Weigh everything in your density sample. Record this weight on your Deck Form. *You must weigh a minimum of 4 observer baskets filled to the prescribed level or about 200 kg of unsorted catch in an alternate bin for density determination.*
7. Use the density formula below to calculate density. *Document all calculations in your logbook!*

$$\text{density (kg/m}^3\text{)} = \frac{\text{wt. of sample (kg)}}{\text{volume of sample (m}^3\text{)}}$$

Ripped Nets, Dumping Codends, or Codend Lost

Occasionally a vessel will dump a partial codend or the net will be torn resulting in the loss of fish before being landed, preventing access to the entire catch. In these cases, visually estimate the amount of catch that was discarded. Add this value to the observer estimate calculated from the accessible portion of catch and to the discard estimate on the OHF.

Use reference marks when possible to obtain the estimate of the discarded portion. If this is not possible, use your best judgment and ask the captain or crew to help estimate the total amount discarded. Document the situation in your logbook. Include why part of the catch was discarded and describe the method used for estimating the discarded catch.



In the event of a lost codend, obtain vessel estimate from Captain or logbook and contact your inseason advisor for guidance

Catch Estimates on GOA Non-Pollock Trawl Catcher Vessels

It is generally advisable to use codend measurements to estimate catch volume in these fisheries. Keep in mind that the deck layout may be complicated and access to the codend to make measurements may be dangerous. Work with the captain and enlist the crew's help early on to explain your expectations and to receive their suggestions to help you obtain codend measurements. Bin volume measurements are often not an option on these boats due to low catch volume. Use your baskets for making density estimates. Using a checker bin for densities can be challenging as the sample size is often too small compared to the size of the bin making the depth of fish reading inaccurate. It is common in the GOA trawl fleet to dump codends in sections which makes accurate bin volumes in the trawl alley not possible.

DISCARD ESTIMATES

Discards on a catcher vessel are any catch not delivered. Discards on a catcher processor are any catch not retained. Observers must make an independent estimate of at-sea discards for all sampled hauls. Discard information for sampled hauls is collected in conjunction with percent retained data. Fisheries managers are able to quantify discards at both the vessel and fleet level using observer discard estimates.

Discards on CPs and Non-Pollock CVs

Independent estimates of discard must be made for all sampled hauls on catcher processors and non-pollock catcher vessels. Discard estimates are not required for unsampled hauls. On these vessels, make estimates of discards for unsampled hauls only if you are able to reliably account for them. Discard estimates are recorded on the OHF.

The discard estimate is always included in the observer estimate on the OHF. For example, your observer estimate is 35000 kg of which you estimate 10000 kg was discarded. On the OHF you record a discard of 10000 kg and observer estimate of 35000 kg.

Discards on Pollock CVs

Independent estimates of discard must be made for all hauls on a pollock CV. This data is essential to managing the pollock shoreside fishery.



If you are on a pollock catcher vessel, you must make independent estimates of discards for all hauls, whether sampled or unsampled.

Discards for all CVs

Fish retained for personal use or bait must be included in your estimate of discards if they are not offloaded and weighed at the plant. Work with your vessel to determine which hauls those fish should be allocated to. For more information see Fish Retained for Bait and Personal Use on page 4-22.

Discard Estimate Methods

The process of estimating total discards differs between catcher vessels and catcher processors. Regardless of the vessel type, *the time spent on this information should be minimal and obtaining a discard estimate should only take a few moments*. On catcher vessels, discards are generated on deck, where you can see all the fish at one time. On catcher processors, discard can occur on deck or any where in the factory. Familiarizing yourself with the flow of fish on the vessel will help you to recognize areas of potential discard. If vessel personnel sort out and discard undesirable fish, or if portions of the catch are dumped overboard, you must estimate the total weight of these discards. Account for catch discarded in one of the following ways:

1. Using visual cues such as how many baskets of discards a sample generated can help you to quantify what you are seeing. For example, if all your samples resulted in one full basket of discards (approximately 40 kg), and those samples were about 1/100th of the entire haul, you can assume there were about 100 baskets of total discards, or about 4000 kg.
2. A simple visual estimate based on your observations may be easiest. Experience with method 1 will help you to make more accurate visual estimates. For example, if you estimate that 10% of the catch was discarded then simply multiply the vessel estimate by .10 and enter that weight for discard on the OHF.
3. Observers on non-pollock trawl catcher processor and

mothership vessels conducting halibut deck sorting, will receive an auto-generated ATLAS message which will include the total weight of deck sorted halibut. This weight must be included in the discard estimate for the haul. For example, you visually determine that 5000 kg were discarded in the factory and the auto generated ATLAS message stated that the total discard weight of deck sorted halibut was 500.26 kg. The total discard estimate for the haul recorded on the OHF is 5500 kg. It is important to note that the auto-generated ATLAS message is sent after the haul has been completed and you have transmitted your species composition and length data.

RECORDING VHF AND OHF DATA

Ensure that the data you record on the VHF and OHF are complete, accurate, and reasonable and there are no transcription errors. The OHF may contain entries for calculated values. All calculations must be recorded in your logbook. In addition, you must record the methods and justifications used to determine independent observer estimates. *You are responsible for your work and must be able to recall all methods and techniques used to collect your data.*

Completing Haul Forms on Trawl Vessels

If you are on a vessel equipped with ATLAS, you must maintain a set of paper VHF and OHF Forms in addition to sending these data electronically. The fishing effort information required on the VHF and OHF should come from the vessel's NMFS logbook, as described previously in this chapter.

Observers must retain the “goldenrod” copies of the vessel logbook pages for each day the observer was assigned. A signed copy of the Daily ELB and the Trip ELB printouts should be collected if your vessel uses an electronic logbook. These pages (goldenrods or ELB printouts) are submitted during debriefing and are used to evaluate your VHF and OHF forms. For expectations on when you will receive signed copies of the goldenrods, or the electronic logbook, see “Record Keeping and Reporting §679.5” on page 20-13.



Keep the “goldenrod” or printed copies of the ELB in a secure place. These forms are confidential, and must not be seen by crew from other vessels.

Completing the VHF on Trawl Vessels

An entry must be made for every day you are assigned to a vessel. Start your entries with the day you embark a vessel and end on the day you disembark the vessel. Skip a line between each day's entries. Make sure that you:

1. Record all hauls retrieved during your deployment whether or not you sampled them for species composition.
2. Record hauls in the order that they were retrieved.
3. Keep data from each vessel, on which you are deployed, separate.
4. Be aware that the ELB software will auto fill the seconds field in the printouts with ‘00’ if the captain does not enter these data to decimal minutes or seconds. Verify this and leave the seconds field on the VHF and in ATLAS blank.

- **Cruise, Permit, Year:** Enter your cruise number. Enter the Vessel permit numbers found on page A-31. For “Year” enter the full year (e.g., “2024”).
- **Observer Name/Vessel Name:** Enter your name and the name of the vessel.
- **Trip Number:** Record the trip number associated with the haul. Trip Form instructions are given in the chapter “TRIP INFORMATION” on page 3-1.
- **Haul Number:** All hauls must be recorded and assigned a number. Haul numbers must be unique for the vessel and in sequential and ascending order. It is preferred that you use the same haul numbering as the captain. Enter “0” for the haul number for each non-fishing day. There can be no duplicate haul numbers for a vessel except for haul number “0.”

Electronic logbooks (ELBs) will not allow duplicate haul numbers during a calendar year. You should use the same numbering system as your vessel if they are using an ELB. *If you are unable to use the same numbering system as the ELB, let your inseason advisor or Observer Program staff know the reason why.*



Occasionally, you may need to skip haul numbers to match the vessel logbook. Document the reasons for skipped haul numbers in your logbook Daily Notes and inform your inseason advisor.

- **IFQ? Y/N:** On trawlers, always enter “N” to indicate that no hauls were fished under an Individual Fishing Quota (IFQ). The only IFQ fisheries are halibut and sablefish longline. This column must be filled out for all hauls.
- **CDQ Number:** For each haul taken under a Community Development Quota (CDQ), record “C” and the last 2 digits of the CDQ group number. The CDQ number can be found on the vessel’s logbook haul information page under “Management Program”

| CDQ # | Group Description |
|-------|----------------------------------|
| C99 | Other unidentified Fishing Group |
| C51 | Aleutian Pribilof Island |
| C52 | Bristol Bay Economic Corp. |
| C53 | Central BS Fisherman’s Assoc. |
| C54 | Coastal Villages Fishing Coop. |
| C55 | Norton Sound |
| C56 | Yukon Delta |
| M01 | Makah Tribe Whiting Association |

- **Gear type:** Enter a code for trawl gear based on the configuration of the gear regardless of how it is fished (mid-water or on the bottom). If you are on a vessel using a type of trawl gear not listed, please contact the Observer Program for instructions.
 1. **Non-pelagic trawl:** a trawl net that fishes on the bottom. It has a series of discs, bobbins, or rollers strung on chain or wire rope (foot rope) attached to the front of the net to protect it from damage. Chaffing gear is also attached to the foot rope to protect the net from obstacles on the bottom.
 2. **Pelagic trawl net:** a trawl net that typically fishes mid-water. It has no discs, bobbins, rollers, or chaffing gear attached to the foot rope.
- **Vessel Type:** Enter a code which identifies how the vessel received and processed fish for any given tow. The codes are:
 1. **Catcher Processor (CP):** The vessel caught and processed its own catch on this tow. Catch was stored in a freezer hold.
 2. **Mothership (or CP)-Unsorted:** The vessel received unsorted catch by codend transfer from a catcher vessel for this haul.

3. **Catcher-only Vessel (CV):** The vessel caught its own fish and retained it for delivery to a processing plant. Onboard, the catch was kept on ice or in refrigerated seawater (RSW) tanks, but was not frozen.
4. **Mothership (or CP)-Sorted:** The vessel received sorted (or potentially sorted) catch from a catcher vessel. Catch was transferred by brailer, by pumping, or by another method other than codend transfer.
5. **All-sold/bait:** The catch from this tow was sold over-the-side to other fishing vessels which will utilize the fish for bait.
6. **CV-discarded:** The entire catch from this catcher-only vessel’s haul was discarded and not delivered. Document any circumstances of the dumping in your daily notes.

- **Gear Performance:** For each haul on a trawler, one of the following codes must be recorded:

- 1-No Problem.
- 2-Problem: a crab pot was in the haul.
- 3-Problem: the net hung up on some obstacle and vessel had to back down.
- 4-Problem: the net ripped.
- 5-Problem: other problem, write an explanation in your logbook Daily Notes.
- 6-Problem: trawl net or codend lost.
- 9-Fishing Duration Affected: the deployment and retrieval times do not reflect true fishing time.

- **Location Code:** This column corresponds to the location entered in the “Deployment Information” and “Retrieval Information” tabs. For hauls, enter “R” to indicate the position corresponds to the Retrieval of a net. A day for which no hauls were retrieved is termed a “Non-fishing day.” For these days, enter an “N” for the location code to indicate that no hauls were retrieved. There must be a position entry for every day you were onboard the vessel. *Observers on motherships should refer to “Catch Information (Haul Forms)” on page 6-1 for instructions on entering delivery information.*

- **Purpose Code:** The Purpose Code provides a label in your data signifying how the data will be used for fisheries management. Enter one of the following codes unless otherwise instructed by Observer Program Staff:
CA - Catch Accounting

CT - Pacific Cod Trawl Cooperative (PCTC). Vessels are required to document in their logbook if they are participating in the PCTC management program. If the vessel does not maintain a logbook, ask the captain to inform you when they are fishing PCTC hauls.

Non-Fishing Days

A non-fishing day is one during which you are assigned to a vessel, and no hauls are retrieved. The trip number will be blank for all non-fishing days. Enter "0" for the haul number and "N" for the location code. In the "Retrieval Information" tab, enter the date and the latitude and longitude of the vessel, *do not include a time*. The position data may be obtained at any point during that day. All assigned days must be accounted for with either a fishing or non-fishing day position. This is the Observer Program's only way to account for all of the days you were assigned to a vessel. Non-fishing days are recorded on both the VHF and the OHF.

Port Coordinates

If you are in one of the ports listed in "Port Codes and Non-Fishing Day Port Positions" on page A-27 for a non-fishing day, you may use the coordinates given as the non-fishing day position. One hundred degrees of longitude are assumed, so do not enter the leading "1".

"Deployment Information" Tab

- **Month/Day:** Enter the month and day the gear was deployed. Write the dates in two digit format (e.g., 01/01 for January 1st).
- **Time:** Enter the time the trawl net enters the water. Copy this time from the vessel logbook, unless you have identified a problem with these data. If the captain is entering data that are not accurate (see "Times That Do Not Reflect True Fishing Duration" on page 4-3), try to provide your own independently collected times. All entries must be in Alaska Local Time (ALT). Use 24 hour time notations, in four digits with no colons.
- **Latitude:** Record the latitude of the "Begin Position of Haul or Set" from the vessel logbook. Record the position to the same level of accuracy as it is recorded in the vessel logbook. Vessels may record their positions to the nearest minute, seconds, or hundredths of a minute. If the vessel listed their positions to the hundredths of a minute, you must convert this value to seconds. To convert from the hundredth of a minute (also called

a decimal minute) to seconds, use the "Decimal Minutes to Seconds Conversion Chart" on page A-45. If you need to do the calculation, use the formula in "Abbreviations, Conversions, and Formulas" on page A-19. Do not enter degree marks or include "N" to indicate North for latitude. Degree, minute, and second entries must be two digits.

- **E or W:** Fill out the "E or W" column to indicate if the longitude is east or west of the 180 degree line.
 - **Longitude:** Record the longitude of the "Begin Position of Haul or Set" from the vessel logbook. One hundred degrees of longitude are assumed, so do not enter the leading "1." Record the position to the same level of accuracy as it is recorded in the vessel log book. Vessels may record their positions to the nearest minute, seconds, or hundredths of a minute. If the vessel listed their positions to the hundredths of a minute, you must convert this value to seconds. To convert from the hundredth of a minute to seconds, use the "Decimal Minutes to Seconds Conversion Chart." If you need to do the calculation, use the formula in "Abbreviations, Conversions, and Formulas" on page A-19. Do not enter degree marks. Degree, minute, and second entries must be two digits.
 - **Average bottom depth and Average gear depth:** Copy the "Average Sea Depth" and the "Average Gear Depth" from the vessel logbook. All entries must be to the nearest whole number. Record both depths in the same unit of measure and label them as fathoms (F) or meters (M) in the "M or F" column.
- ### "Retrieval Information" Tab:
- **Month/Day:** Enter the month and day the gear was retrieved. A haul is assigned to a date according to the time when retrieval of trawl gear cable begins. This time may not be the same day the net was set or the same day you sample. Hauls with retrieval times before 0000 hours are attributed to the previous day and retrieval times on or after 0000 hours are assigned to the next day. Write the dates in two digit format (e.g., 01/01 for January 1st).
 - **Time:** Enter the time when the retrieval of trawl gear cable begins. Copy this time from the vessel logbook unless you have identified a problem with these data. Follow the same rules as described for time under the Deployment Information tab. Hauls retrieved at exactly

2400 hours should be recorded for the following day as 0000 hours.

- **Latitude and Longitude:** Record the positions of the “End Position of Haul or Set” from the vessel logbook. Follow the same rules as described for deployment.

Completing the OHF on Trawl Vessels

An entry must be made for every day you are assigned to a vessel: Start your entries with the day you embark on a vessel and end them on the day you disembark the vessel. Skip a line between each day’s entries. For every entry on the VHF, there must be a corresponding entry on the OHF. When placed side-by-side, you should be able to read the VHF and OHF forms straight across all rows. The information for a haul on one form should line up with the same haul information on the other form. Always start a new OHF when you start a new VHF. Keep a separate set of data forms for each vessel to which you are assigned.

Cruise, Permit, Year: Enter your cruise number. Enter the Vessel permits found on page A-31. For “Year” enter the full year (e.g., “2024”).

Observer Name/Vessel Name: Enter your name and the name of the vessel.

Full Name of Catcher Boat and ADF&G Number: Fill in these two items on the OHF only if you are on a mothership. For all unsorted codends and sorted catch delivered to your ship, you must record the ADF&G permit number of the delivering vessel.

Haul Number: Haul numbers must correspond to the ones used on the VHF. If a line is skipped on the VHF, skip the same line on the OHF. Non-fishing day entries must match the VHF with a haul number of “0.”

Haul Sampled By: Enter the cruise number of the observer who sampled this haul for species composition. Always enter “0” if there is no species composition data collected for a haul or in the event that composition data has to be deleted as instructed by your inseason adviser or debriefer. If more than one observer samples a haul, record the cruise number of the observer who sampled the majority of the haul.

RST On Haul?: Enter the code which reflects the haul status on the RST:

Y - Yes, this is an “on” haul.

N - No, this is not an “on” haul.

X - RST is not being used, all hauls are sampled.

RBT On Break?: Enter the code which reflects whether or not you were taking a break prescribed by the Random Break Table:

Y - Yes, I’m on break during this haul.

N - No, I’m not on break during this haul. If you aren’t using the RBT, this is your default code.

Sample Design: Enter the code that best describes your method used for collecting your composition samples. See “Sample Designs for Species Composition” on page 2-25 for a description of each code. Leave blank for unsampled hauls:

- 5-Opportunistic
- 6- Simple Random
- 7- Systematic Random
- 9- Other Random
- 10-Census
- 11-Other
- 12-Unknown

Observers on vessels conducting halibut deck sorting must use the sample design code that describes the method used for collecting species composition samples in the factory.

Sample Unit Type: Enter the code that best describes the sample unit used for completing your composition sample. See “Sample Unit Type for Species Composition” on page 2-24 for a description of each unit type. Leave blank for unsampled hauls:

- 1-Gear
- 2-Time (Not Used)
- 3-Weight
- 4-Volume
- 5-Other
- 6-Unknown

Percent Monitored for Marine Mammals: If you monitor for marine mammals during any portion of the codend dumping enter “100.” If no portion of the codend dumping was monitored for marine mammals enter “0.” No other values are valid on trawlers.

Gear Descriptor: On vessels using trawl gear, leave this column blank.

Fishing Method: On vessels using trawl gear, leave this column blank.

Vessel's Total Catch Estimate in Metric Tons: Record the "Estimated Round Catch Weight" from the vessel logbook. If the vessel is not required to keep a logbook you must obtain the vessel estimate from the captain. If the estimate is in pounds, convert the estimate to metric tons and round to the nearest two decimal places. Show this calculation in the observer logbook. *There must be an entry for every haul.*

Estimated Discard Weight in Kilograms: Record the estimated discard weight in kilograms, rounded to the nearest whole kilogram. If there were no discards, enter a zero value in the discards column for that haul. All sampled hauls must have an entry. If you do not know whether or not there were discards, leave the field blank. If catch on a CV is used for bait or personal use, record this with the discard estimate for the appropriate haul.

"Trawl Vessels" Tab:

Observer's Catch Estimate in Kilograms: Enter your independent observer estimate for each haul for which an estimate was made. Record the estimate in kilograms, rounded to the nearest whole kilogram. Leave this field blank if you did not obtain an observer estimate. If you determined there was no weight for the catch, enter a zero value in the observer estimate field.

B, C or W: Record how each catch estimate was made with a W, C or B. Enter "W" if the entire catch was weighed by you on your observer scales or on the vessel's certified flow scale, "B" if you used a bin volume calculation or "C" if you used a codend estimate.

Density in Kilograms/m³: Record the density used to calculate an observer estimate from a known volume. Record the density in kilograms per cubic meter, rounded to two decimal places. You must record a density if the observer estimate was obtained using a bin or codend volume.

Volumetric Estimate in m³: If your observer estimate was done via a bin or codend volume, enter the volume you calculated to the nearest two decimals. If you did not

do an observer estimate or you did a weighed estimate, leave this column blank.

Haulback Bird Observation Code: You should monitor all or some portions of the haulback. Monitor from the start of retrieval to the codend being brought fully onboard. While monitoring, watch the third wire and main wires for seabird interactions as well as the net and codend for seabird entanglement. If there are seabird mortalities or interactions, record those incidents on the Bird Data Forms or in ATLAS. For more instructions on recording seabird interactions refer to "Recording Bird Data" on page 16-9.

Record the code which best describes the haulback observation:

0 - No Monitoring: For haulbacks you did not monitor in any way for seabird mortality. However, if birds were provided to you by the crew, record the interaction on the bird data form or in ATLAS.

1 - Monitored from Beginning of Haulback: For haulbacks monitored from the beginning of the haul back (within several minutes of when they started to winch in the main wires).

2 - Monitoring Started When Trawl Doors Secured: For haulbacks monitored from when the trawl doors are secured on the stern.

3 - Monitored from the Beginning of Haul Until Short-wired: For haulbacks that were short-wired, and you monitored from the beginning (when they started winching in the main cable) until the short-wire period started.

5 - Monitoring Started When Trawl Sonar on Deck: For haulbacks monitored from the time the trawl sonar (suitcase) reaches the deck.

6 - Monitoring Started When Net is Being Brought on Deck: For haulbacks monitored from when you arrive on deck and the net is being brought onboard.

7 - Monitoring Started at End of Short-wire Period: Haulback was short-wired, and you started observations after the short-wire period (prior to suitcase or head rope coming on board).

8 - Monitoring Started When Net is Already On Deck: You arrive on deck to monitor the haulback, and the codend is already onboard (you record any mortalities of birds provided by the crew).

9 - Other Monitoring Situation: Use this code for situations that are not addressed above (e.g. you watched the haulback, but you were unable to monitor the third wire and the main wire from the area of the deck where it was safe to watch the haulback). Document these situations in your log book.

Short-Wired?: Enter “Y” or “N” to denote whether the haul was short-wired during the haulback. This data point should be collected through personal observations. If you are unable to verify this, consult the captain or mate for this information. “U” must only be used on motherships and is not a valid option for trawler vessels. Do not record a “Y” when the net is brought to the surface during the tow but then returned to fishing depth. A short-wired haul is when the trawl doors are pulled to the surface and the net is towed behind the vessel until it is brought onboard.

Y - Yes: the net was short-wired.

N - No: the net was not short-wired.

U - Unknown: only used for observers on motherships.

Catcher boat’s ADF&G Number: Fill in this column on the OHF only if you are on a mothership. For all unsorted codends and sorted catch delivered to your ship, you must record the ADF&G permit number of the delivering vessel.

“Longline and Pot Vessels” tab

These fields are for vessels using fixed gear only and are not used for trawl vessels.

DETERMINING OFFLOAD DELIVERY WEIGHT

When a catcher vessel delivers its catch to a processing plant, the fish are weighed. The scales at each plant are tested by the State of Alaska annually and they do not need to be tested daily in order for you to use this weight as a delivery weight. The weight of everything delivered is totaled and provided to the vessel on the Alaska Department of Fish and Game (ADF&G) fish ticket. Catcher vessel observers will record delivery information on the Offload Form (see page 4-23 for Offload Form instructions).

The fish ticket will be the best source of data for determining delivery weight. Plants are allowed to record the number only of prohibited species for some

deliveries, however fisheries managers need weight data as well. If you are using the fish ticket for a delivery weight, the total round weight will be documented in the “Observer Only” box at the bottom of the fish ticket (see Figure 4-11). This weight should include everything that was delivered to the plant. If the total round weight on the fish ticket is incorrect, make the appropriate changes and document the situation in your logbook. For information on interpreting fish tickets and tips on how to avoid potential errors see Figure 11-2 on page 11-18. *Though they may appear on the fish ticket, at-sea discards (code 98) are never included in your delivery weight.*

Obtaining Your Fish Ticket

Work with the plant observer (if available) and plant personnel to obtain the fish ticket information for your delivery. It will be expected that you try to obtain a fish ticket prior to leaving your port. Fish tickets can be obtained from the processing facility where your delivery occurred or from Observer Program staff. Check with the plant office to find out when you can expect the fish ticket (i.e. landing report) to be ready. There is usually a 2-3 day wait for the plant office to issue a fish ticket. At the first opportunity you must obtain your fish ticket and submit your completed plant/vessel offload information to NMFS. Fish tickets contain confidential data, and must be secured at all times. It is expected that no one but you see this fish ticket or have access to it.

With the exception of GOA pollock deliveries, offload information should never be entered into ATLAS until you obtain your fish ticket. GOA pollock offload data must be entered into ATLAS and submitted to the Observer Program before you embark on your next vessel.

GOA Pollock CV Delivery Weight Instructions

In the Gulf of Alaska (GOA) pollock fishery, the plant/vessel offload data from observed pollock vessels is critical to effective inseason management of this fishery. It is recognized that the fish ticket from which a total delivery weight is obtained is not available immediately following an offload. Without a total delivery weight your salmon retention data cannot be entered into the ATLAS program. To ensure these data are available to fisheries managers in a timely manner, you must complete the following steps before embarking on another vessel:

- Enter the sum of the vessel estimates for the hauls that

are included in the offload into the total delivery weight field.

- Leave the Landing Report ID Number number blank.
- Submit these data along with all other information from the trip to NMFS via ATLAS with an inseason message indicating that the delivery weight is derived from the vessel estimates.
- Once the fish ticket is obtained, enter the final delivery weight and Landing Report ID Number on the Plant/Vessel Offload Form and resubmit the data via ATLAS.

Landing Report Verification

The delivery information may be verified by the plant observer. Plant observers need to give you documentation on how verification was done when they complete this task. For more information on this aspect of a plant observer's duties see "Delivery Worksheet Verification" on page 11-9.



You must verify the delivery information before you record it on the Plant/Vessel Offload Form. You are responsible for knowing and documenting how all your data were derived!

You are responsible for your data and must know how delivery information were derived. If no plant observer is assigned to the plant you deliver to, CV observers must document the delivery methods. Verifying delivery methods requires documenting how fish were offloaded (pumped or by hand) and how they were weighed (hopper scale, brailer, totes, etc.).

Catcher vessel observers must be able to provide details about their offload and the accuracy of the landing report, including verification of the following:

- Do the species reported on the landing report match your observations of catch at sea and the offload?
- Are the delivery weights correct? Was the correct product recovery (PRR) code applied to fish that were bled or processed at sea?
- Is the condition of fish delivered properly reported on the Landing Report? For example, if fish were bled at sea are they reported on the fish ticket as bled fish?
- Was ice/slime deducted, if so was it significant and was this correctly accounted for?

- Are discards at sea reported on the Fish Ticket?

Document any discrepancies between the landing report information and what you may have observed at sea or during your offload. For more information on reading your landing report see "ADF&G Electronic Groundfish Ticket Instructions" on page 11-18.

Fish Retained for Bait and Personal Use

Your vessel will occasionally keep fish for personal use (code 95) or retain fish for bait (code 92). If these codes are present on the fish ticket, it is your responsibility to work with your vessel and/or plant personnel to verify if those fish were delivered and weighed at the plant.

- If weighed at the plant, include codes 92 and 95 in your total delivery weight.
- If not, do not include them in your delivery weight. Instead, those fish must be accounted for in your estimate of discards. Work with the vessel to determine which hauls those fish should be allocated to.

Organisms Delivered but Not Weighed

Total delivery weight must reflect everything that was delivered to a plant. There are occasions when sharks and other large organisms are delivered to a plant but not weighed because they are too big to be pumped into the factory. In this event, you must estimate the weight of the large organism and include it in the total delivery weight. You must provide this information to the plant observer(s) as they are also responsible for incorporating this weight into the delivery weight.

PARTIAL COVERAGE: ADDITIONAL OFFLOAD GUIDELINES

Plants and floating processors that do not receive Bering Sea pollock deliveries fall into the partial coverage category and are not required to have observer coverage. The vessel observer will have to obtain delivery weight information and their landing report(s) on their own from the plant or an Observer Program office. The vessel observer will have to verify their own delivery weights.

GOA Plant Landing Reports

Often there will be a delay of several days from the completion of the offload to obtain the landing report. Should the vessel observer still be in port, they may request the landing report from the plant office. You

may also obtain copies of the landing report from the Observer Program. Deliveries to Gulf of Alaska plants will often generate multiple landing reports for a single offload (this is common in the halibut and sablefish fleet) so the observer must be sure to obtain all copies from their offload.

GOA Plant Delivery Schedule

Notification of the start of your offload is the responsibility of the vessel you are assigned to. Delivery schedules at GOA plants often change throughout the day. If you are in the pollock fishery, effective communication is vital to salmon genetics and salmon retention data being collected. The offload must be monitored in its entirety. For pollock offloads the vessel observer must ask to be notified when the offload is going to start and should be at the plant or on the vessel early in case the offload starts earlier than scheduled.

Partial Coverage Sector Offload Verification

Observers deployed in the partial coverage sector must also verify that an offload occurred. If you are not staying on the vessel you need to communicate to the captain that you must be notified when the offload begins or given the offload start time so that you have the opportunity to go to the plant and verify the offload is taking place.

For all deliveries, vessel observers should be able to describe the offload process and how the plant is weighing the delivery. For all non-pollock deliveries these observations can be made during the first few minutes of the offload after which you are no longer required to be present. Document the offload process in your daily notes. For pollock offloads you must complete a diagram of the processing plant in your logbook. Include how the fish are pumped from the boat and all areas where you monitored the process and sampled fish.

Prohibited Species Discarded at Sea on Pollock Catcher Vessels

Prohibited species discarded at sea, from both inside and outside your samples, are included in your estimate of discards on the Observer Haul Form. At-sea discard of salmon is prohibited. If this occurs you must notify NMFS staff immediately and give the number of each salmon species that was discarded to the plant observers for inclusion in their Salmon Retention Data.

Note that fish discarded at-sea are not included in your offload delivery weight; they are listed on the fish

ticket under code 98. Observers on vessels in the GOA must include salmon discarded at sea in their Salmon Retention Data (see “GOA Vessel Observer Offload Salmon Retention Count” on page 5-31).

RECORDING OFFLOAD DATA ON TRAWLERS

Observers on catcher trawlers must report offload information on the Vessel/Plant Offload Form.

Data for the Vessel/Plant Offload Form may be obtained from the Alaska Department of Fish and Game (ADF&G) fish ticket, electronic scale readout, scale weights recorded by a plant representative, the plant’s NMFS logbook as well as from observations by the observer. *If you are on a vessel equipped with ATLAS you must maintain a set of paper offload forms in addition to sending these data electronically.* See “GOA Pollock CV Delivery Weight Instructions” on page 4-21 for GOA pollock offload specific instructions.

Catcher Vessels Delivering to Tender Vessels

If your vessel delivers the catch to a tender vessel, remember the following:

- Report the offload information on the Vessel/Plant Offload Form following the same guidelines as when delivering to a shore side processing plant or floating processor.
- It may be more difficult to obtain the fish ticket for this offload since the fish ticket will not be generated until the tender vessel delivers the catch to a shore side plant or floating processor. Document in your daily notes detailed information about this delivery, including information that will help you verify delivery methods and offload data reported on the fish ticket.
- You are not required to monitor any deliveries to a tender vessel.

Cruise Number, Permit, Year, Observer Name, and Vessel/Plant name: Enter the cruise number supplied in your training or briefing. Enter the vessel permit found in the manual on page A-31. For “Year” enter the full year (e.g., “2024”). If data on the Offload Form straddles the end of one year and beginning of the next, a new form should be used to capture the completion date information. Enter your name and the name of the vessel to which you are assigned.

Processor Name and Processor Permit: In the box in the upper left hand corner, fill in the name and processor permit for each of the plants to which your vessel delivers. You only need to record each plant once for each data set. There is a list of processor permits for shoreside or floating plants and motherships on page A-29. A more complete list is available in ATLAS. If your vessel delivers to a plant that is not on the list, enter 99999 (for “unknown”) and contact NMFS staff as soon as possible.

Offload Trip(s) First/Last: Enter the trip numbers for all trips associated with an offload. Use these guidelines when completing the “First” and “Last” columns: Record the first trip when you board the vessel to the trip where the offload occurs.

- **Offload #1:** You board your vessel, it travels to the fuel dock (trip 1) and then goes fishing (trip 2). You tie up at the dock and offload (end of trip 2). On the offload form “First” trip will be trip 1 and “Last” trip will be trip 2.

The following offloads “first” trip number will be that trip that follows the previous offload.

- **Offload #2:** The vessel moves to the fuel dock (trip 3) then goes fishing (trip 4). You tie up at the dock and offload (end of trip 4). On the offload form “First” trip will be 3 and “Last” trip will be 4. Record the trip number in both columns if there is only one trip associated with the offload.

- **Offload #3:** The vessel heads back out to fish (trip #5) and returns to deliver (end of trip 5). On the offload form “First” trip will be trip 5 and “Last” trip will be trip 5. In the event that your vessel offloads its catch to 2 or more processors, record the range of all trips associated with the entire catch, for example:

- **Offload #4 and #5:** The vessel heads back out to fish (trip 6). You return and deliver half the catch to Akutan (end of trip 6) and then travel and deliver the rest of its fish to Sand Point (trip 7). For offloads #4 and #5, the “First” trip will be trip 6 and the “Last” trip will be trip 7.

Offload Number: All offloads must be recorded and assigned a number. Offload numbers must be unique for the cruise/vessel and should be sequential and ascending, beginning with “1.”

Completion Date: Enter the month and day the offload was completed. Write the dates in two digit format (e.g. “01/01”).

Gear Type and NMFS Area: These columns are used by plant observers only.

Total Delivered, LB or KG: (Refer to “Determining Offload Delivery Weight” on page 4-21 for fishery specific delivery calculation protocol). Record the total round weight delivered to the plant for that trip. Delivery weights can be entered in either pounds or kilograms. Delivery weights recorded in pounds must be recorded to the nearest whole pound. Weights reported in kilograms must be recorded to the nearest whole kilogram. Remember that when cut or bled fish are delivered, the round weight must be used. Round weights are listed at the bottom or end of the fish ticket.

- If there are multiple fish tickets with the same Landing Report ID Number, sum the individual delivery weights to obtain a single total delivery weight.
- Occasionally, there may be more than one Landing Report ID Number for an offload. If this occurs, list each Landing Report ID Number separately in the Offload Form with the corresponding total delivery weight for that individual Report.
- GOA pollock- Enter the sum of the vessel estimates for the hauls that are included in the offload into the total delivery weight field. *Update the delivery weight once you receive the actual landing report.*

Total Pollock Weight, Were all Groundfish Weighed?, ADF&G Number of Delivering Vessel: These columns are used by plant observers only.

Receiving Processor Permit Number: For each offload, record the processing plant’s permit number. The permit numbers should be one of those you listed under Processor Name and Processor Permit Number described above. If a delivery is split and sold to more than one processor, you should make an entry on the Vessel/Plant Offload Form for each delivery. If this, or any other incident out of the ordinary occurs, please note the circumstances in your logbook.

Was Catch Sorted (Y/N): Record “Y” for any delivery that was sorted at sea. This includes extensive sorting by crew, partial or whole codends discarded at sea, and loss of fish from a ripped codend. Record “N” if the crew did

not sort the catch before delivery. Sorting of a few large organisms does not constitute extensive sorting (i.e. salmon shark).

Tender Offload (Y/N): Record “N” for all offloads.

Landing Report ID Number: Record the Landing Report ID Number associated with the delivery for this vessel. As a vessel observer this number will be taken directly from the fish ticket, a delivery worksheet provided by the plant observer, or may be obtained from the plant office along with other catch information.

- Record the Landing Report ID Number exactly as it appears on the fish ticket.
- Multiple fish tickets associated with the same offload to a single processor will usually have the same Landing Report ID Number. In this case, there should be a single line of entry for this delivery.
- GOA pollock- Leave this field blank until you receive the actual landing report.

Occasionally, there may be more than one Landing Report ID Number for an offload. If this occurs, each one must be listed separately on the Offload Form as if they were separate offloads. The trip number will remain the same, but the offload numbers and total delivery weights will be unique to each Landing Report ID Number.

TRAWL CATCH FORM EXAMPLES

The following catch form examples illustrate how to properly record trawl catch effort data.

| Cruise | Permit | Year |
|--------|--------|------|
| 25670 | 2345 | 2023 |

Page 1 of 1

Plant/Vessel Offload Form

| Vessels Only | |
|-----------------------|----------------------|
| Processor Name | Processor Permit No. |
| Global Sfds. (Kodiak) | 27989 |

Observer Name Reginald Dwight

Vessel/Plant Name Honky Cat

| Plants Only | | |
|-------------------|------------------------|-------------------|
| Catcher Boat Name | Catcher Boat ADF&G No. | Vessel Permit No. |
| | | |

Resubmission (Circle All Changes)

| Offload Trip(s) | Offload No. | Completion Date | | Plants only | | Total Delivered | Kg or Lb | Total Pollock Weight | ADF&G No. of Delivering Vessel | Receiving Processor Permit No. | Was Catch Sorted? (Y/N) | Tender Offload? (Y/N) | Landing Report ID No. | Elanding Management Program | CDQ No. |
|-----------------|-------------|-----------------|-----|-------------|-----------|-----------------|----------|----------------------|--------------------------------|--------------------------------|-------------------------|-----------------------|-----------------------|-----------------------------|---------|
| | | Month | Day | Gear Type | NMFS Area | | | | | | | | | | |
| 1 | 2 | 1 | 07 | 15 | | 300401 | Lb | | | 27989 | N | N | 3336815 | | |
| 3 | 3 | 2 | 07 | 19 | | 167445 | Lb | | | 27989 | Y | N | 333919 | | |
| 4 | 5 | 3 | 07 | 22 | | 117065 | Lb | | | 27989 | N | N | 333942 | | |

ALASKA DEPARTMENT OF FISH & GAME ELECTRONIC GROUND FISH TICKET

DO NOT WRITE IN THIS SPACE
E23 847006

PURCHASER

| Statistical Area WorkSheet | | | |
|----------------------------|-----|------------|---|
| Stat. Area | % | Stat. Area | % |
| 620 | 100 | | |

Fish ticket for Offload 1

Vessel: HONKY CAT
ADF&G NO.: 48946
Permit: H7MB 39079P 1106O HESPER BERG
 Mag Stripe Read

Owner: F5099 Global Seafoods Kodiak
Custom Processor:

Crew Size: 5
Observers: 1 onboard
Mgmt Pgm: OA
Port of Landing or off-shore operation type: KOD Kodiak
Type of Gear used: 47 Pelagic/mid-water trawl

Date Fishing Began (Gear in Water): 07/12/2023
Days Fished: 3
Date Landed: 07/15/2023

PARTIAL DELIVERY:
 Partial Delivery
 Dock Delivery
 Last Landing for Trip
 Multiple IFQ Permits

| SPECIES | STAT AREA | DEL. COND | SCALE WEIGHT | NUM | DISP. | SIZE & GRADE | SOLD WEIGHT | PRICE | AMOUNT |
|---------------------|-----------|-----------|--------------|-----|--------------|--------------|-------------|-------|--------|
| 270 Pollock | | 01 Whole | 240,286 | | 60 Sold | 300-500g | | | |
| 270 Pollock | | 01 Whole | 59,157 | | 41 Fish meal | 501-800g | | | |
| 122 Flathead sole | | 01 Whole | 103 | | 60 Sold | | | | |
| 121 Arrow fldr | | 01 Whole | 321 | | 41 Fish meal | | | | |
| 270 Pollock | | 01 Whole | 182 | | 41 Fish meal | | | | |
| Discards | | | | | | | | | |
| 410 Chinook | | 01 Whole | 195 | 40 | 99 Disc dock | | | | |
| 235 Herring bycatch | | 01 Whole | 157 | | 99 Disc dock | | | | |
| Total: | | | | | | | | | |

I HEREBY ATTEST THAT THESE FISH WERE CAUGHT IN COMPLIANCE WITH ADF&G REGULATIONS.

Permit Holder's Signature _____ Date _____

Fish Received by _____ Date _____

Landing Report ID: 3336815 CPEC Serial Number: 269627

Arrow fldr Round Weight: 321
 Flathead sole Round Weight: 103
 Herring bycatch Round Weight: 157
 Pollock Round Weight: 299,625
 Chinook Round Weight: 195

| Taxes | | |
|--------------|------|--------|
| Landings Tax | Rate | Amount |
| AFA Fee | | |
| Other | | |
| Total | | |

| Observer only | |
|-----------------------------|--|
| Total Round Weight: 300,401 | |
| ODDS Rep. Number: | |
| ADF&G only | |
| Logbook | |
| Observer | |
| Interview | |

Notes Section: Includes the total round weight by species of everything listed in the Main Body.

Total Delivered for Offload 1 was obtained from the Observer only box **Total Round Weight in the fish ticket. This weight should include everything that was delivered to the plant

Main Body: Includes everything that was delivered to the plant and how it was used or disposed of. It should also include fish that were caught by the boat but not delivered.

Figure 4-11: Example of a Catcher Vessel Offload Form and Corresponding Fish Ticket for Offload 1

Vessel Haul Form

Page 7 of 8

| | | | | | |
|------------------------|-----------------------|---------------------|------------------------------------|--|-------------------------------|
| Cruise 25982 | Permit 7891 | Year 2023 | Observer Name <u>David Gilmour</u> | | Vessel Name <u>High Hopes</u> |
|------------------------|-----------------------|---------------------|------------------------------------|--|-------------------------------|

| Trip No. | Haul No. | IFO? Y/N | CDO No. | Gear Type | Vessel Type | Gear Performance Location Code | Pur. Code | Deployment Information | | | | | | | | | | Retrieval Information | | | | | | | | | | | | | | |
|----------|----------|----------|---------|-----------|-------------|--------------------------------|-----------|------------------------|-----|------|--------------|------|------|--------|------------|------|------|-----------------------|--------------------|--------|-----|-----|------|--------------|------|------|-----------|---|----|----|----|--|
| | | | | | | | | Mo. | Day | Time | Latitude (N) | | | E or W | Longitude | | | Average Bottom Depth | Average Gear Depth | M or F | Mo. | Day | Time | Latitude (N) | | | Longitude | | | | | |
| | | | | | | | | | | | Deg. | Min. | Sec. | | Deg. (100) | Min. | Sec. | | | | | | | Deg. (100) | Min. | Sec. | | | | | | |
| 11 | 216 | N | | 1 | 3 | 1 | R | CT | 04 | 05 | 0704 | 54 | 24 | 20 | W | 62 | 54 | 40 | 46 | 46 | F | 04 | 05 | 0932 | 54 | 21 | 11 | W | 63 | 03 | 25 | |
| 11 | 217 | N | | 1 | 3 | 1 | R | CT | 04 | 05 | 1008 | 54 | 21 | 08 | W | 63 | 05 | 59 | 47 | 47 | F | 04 | 05 | 1201 | 54 | 16 | 27 | W | 63 | 16 | 19 | |
| 11 | 218 | N | | 1 | 3 | 1 | R | CT | 04 | 05 | 1245 | 54 | 17 | 29 | W | 63 | 15 | 19 | 50 | 50 | F | 04 | 05 | 1504 | 54 | 23 | 21 | W | 63 | 06 | 35 | |
| 11 | 219 | N | | 1 | 3 | 5 | R | CT | 04 | 05 | 1516 | 54 | 23 | 10 | W | 63 | 07 | 46 | 50 | 50 | F | 04 | 05 | 1715 | 54 | 18 | 55 | W | 63 | 13 | 45 | |
| | 0 | | | | | | N | | | | | | | | | | | | | | | | | | | | | | | | | |
| 12 | 220 | N | | 1 | 3 | 1 | R | CT | 04 | 07 | 0024 | 54 | 24 | 15 | W | 62 | 56 | 28 | 48 | 48 | F | 04 | 07 | 0241 | 54 | 24 | 17 | W | 62 | 54 | 30 | |
| 12 | 221 | N | | 1 | 3 | 2 | R | CT | 04 | 07 | 0315 | 54 | 35 | 49 | W | 63 | 55 | 44 | 50 | 50 | F | 04 | 07 | 0600 | 54 | 27 | 13 | W | 63 | 00 | 52 | |
| 12 | 222 | N | | 1 | 3 | 1 | R | CT | 04 | 07 | 0620 | 54 | 24 | 22 | W | 62 | 01 | 08 | 44 | 44 | F | 04 | 07 | 0906 | 54 | 24 | 19 | W | 62 | 54 | 41 | |
| | 0 | | | | | | N | | | | | | | | | | | | | | | | | | | | | | | | | |
| 13 | 223 | N | | 1 | 3 | 1 | R | CT | 04 | 09 | 0105 | 54 | 31 | 09 | W | 62 | 53 | 55 | 53 | | F | 04 | 09 | 0335 | 54 | 34 | 14 | W | 62 | 53 | 49 | |
| 13 | 224 | N | | 1 | 3 | 1 | R | CT | 04 | 09 | 0400 | 54 | 25 | 23 | W | 62 | 53 | 16 | 49 | | F | 04 | 09 | 0710 | 54 | 21 | 31 | W | 62 | 53 | 12 | |

Comments:

Observer Haul Form

Page 7 of 8

| | | | | | |
|------------------------|-----------------------|---------------------|------------------------------------|--|-------------------------------|
| Cruise 25982 | Permit 7891 | Year 2023 | Observer Name <u>David Gilmour</u> | | Vessel Name <u>High Hopes</u> |
|------------------------|-----------------------|---------------------|------------------------------------|--|-------------------------------|

| Haul No. | Haul Sampled By (Cruise No.) | RST On Haul? (Y= On, N= Off, X= NA) | RBT On Break? (Y= On Break, N= No Break) | Sample Design | Sample Unit Type | % Monitored for Marine Mammals | Gear descriptor | Fishing Method | Trawl Vessels | | | | Longline and Pot Vessels | | | | | | | |
|----------|------------------------------|-------------------------------------|--|---------------|------------------|--------------------------------|-----------------|----------------|-----------------------------------|-------------------------------|-------------------------------|------------|------------------------------|---------------------------------------|--------------|--------------------------------------|---|------------------------|--|--|
| | | | | | | | | | Vessels Total Catch Estimate (mt) | Estimated Discard Weight (kg) | Observers Catch Estimate (kg) | B, C, or W | Density (kg/m ³) | Volumetric Estimate (m ³) | Hook Coll. # | # of Segments in Set (Longline Only) | Total Pots (or Hooks) in Set (required for pot vessel only) | Flow Scale Weight (MT) | | |
| 216 | 25982 | Y | N | 7 | 3 | 100 | | | 26.00 | 6250 | 31250 | C | 961.23 | 32.51 | 1 | N | | | | |
| 217 | 25982 | Y | N | 7 | 3 | 100 | | | 19.00 | 1170 | 20731 | C | 961.23 | 21.27 | 1 | N | | | | |
| 218 | 0 | N | N | 7 | 3 | 0 | | | 23.00 | | | | | 0 | N | | | | | |
| 219 | 25982 | Y | N | 7 | 3 | 100 | | | 15.00 | 1750 | 17504 | B | 961.23 | 18.21 | 2 | N | | | | |
| 0 | | | | | | | | | | | | | | 2 | | | | | | |
| 220 | 25982 | Y | N | 7 | 3 | 100 | | | 27.00 | 4140 | 27619 | C | 981.15 | 28.15 | 2 | N | | | | |
| 221 | 25982 | Y | N | 7 | 3 | 100 | | | 20.00 | 1001 | 20035 | C | 981.15 | 20.42 | 2 | N | | | | |
| 222 | 0 | Y | Y | 7 | 3 | 0 | | | 25.00 | | | | | 0 | N | | | | | |
| 0 | | | | | | | | | | | | | | | | | | | | |
| 223 | 25982 | Y | N | 7 | 3 | 100 | | | | | | | | 29.63 | 2 | N | | | | |
| 224 | 25982 | Y | N | 7 | 3 | 100 | | | 28.00 | 2700 | 31110 | C | 975.46 | 31.89 | 1 | N | | | | |

Documenting the use of the RST in combination with the RBT.

Comments:

Figure 4-13: Examples of VHF and OHF Forms From a Catcher Vessel Fishing for Pacific Cod in the BSAI

| Cruise | Permit | Year |
|--------|--------|------|
| 25982 | 7891 | 2023 |

Plant/Vessel Offload Form

Page 2 of 2

Vessels Only

| Processor Name | Processor Permit No. |
|--------------------------|----------------------|
| Trident Sfds -Akutan- | 5306 |

Observer Name David Gilmour
Vessel/Plant Name High Hopes

Plants Only

| Catcher Boat Name | Catcher Boat ADF&G No. | Vessel Permit No. |
|-------------------|------------------------|-------------------|
| | | |

Resubmission (Circle All Changes)

| Vessels Only | | | Plants only | | Plants only | | Plants only | |
|-----------------|-------------|-----------------|-----------------|----------|----------------------|--------------------------------|--------------------------------|-----------------------|
| Offload Trip(s) | Offload No. | Completion Date | Total Delivered | Kg or Lb | Total Pollock Weight | ADF&G No. of Delivering Vessel | Receiving Processor Permit No. | Landing Report ID No. |
| First | Last | Month | Day | | BSAI Pollock Only | | Vessels Only | |
| 11 | 11 | 09 | 04 | 06 | 161902 | | 5306 | 333421 |
| 12 | 12 | 10 | 04 | 07 | 132990 | | 5306 | 333505 |
| 13 | 13 | 11 | 04 | 09 | 119573 | | 5306 | 333607 |

Total Delivered for Offload 10 was obtained from the **Observer only** box

Total Round Weight in the fish ticket. This weight should only include what was delivered to the plant

Delivery condition "03-Bled" indicates the fish were not delivered whole. A PRR is applied to calculate the round weight of these fish. The Notes Section contains the round weight of all the species listed in the Main Body

Discards at sea should not be included in the Total Round Weight listed in the **Observer only** box

**ALASKA DEPARTMENT OF FISH & GAME
ELECTRONIC GROUND FISH TICKET**

DO NOT WRITE IN THIS SPACE

Fish Ticket for Offload 10

E23 841551

Statistical Area Worksheet

| Stat. Area | % | Stat. Area | % |
|------------|-----|------------|---|
| 620 | 100 | | |

| | | | |
|--|--|----------------------|---|
| Vessel HIGH HOPES | Crew Size 9 | Mgmt Pgm OA | Port of Landing or off-shore operation type AKU Akutan, Akutan Bay Type of Gear used 07 Non-pelagic/bottom trawl |
| ADF&G NO. 72252 | Observers 1 | ID | |
| Permit M7BG 11120G 1016 I NELSON CHRIS R | Date Fishing Began (Gear in Water) 04/07/2023 | Days Fished 1 | |

✓ Mag Stripe Read

| | | |
|------------------------------------|-------------------------------|---|
| Owner: F0939 Trident Akutan | Date Landed 04/07/2023 | PARTIAL DELIVERY: <input checked="" type="checkbox"/> Partial Delivery <input type="checkbox"/> Dock Delivery <input type="checkbox"/> Last Landing for Trip <input type="checkbox"/> Multiple IFQ Permits |
| Custom Processor: | Date Landed 04/07/2023 | |

| SPECIES | STAT AREA | DEL. COND | SCALE WEIGHT | NUM | DISP. | SIZE & GRADE | SOLD WEIGHT | PRICE | AMOUNT |
|-------------------|-----------|-----------|--------------|-----|---------------|--------------|-------------|-------|--------|
| 110 P. cod | | 03 Bled | 129,325 | | 60 Sold | Trawl 23+ | | | |
| 270 Pollock | | 01 Whole | 252 | | 60 Sold | Trawl 19-23 | | | |
| 125 Rex sole | | 01 Whole | 201 | | 60 Sold | Bycatch | | | |
| 070 Octopus | | 01 Whole | 51 | | 60 Sold | Bycatch | | | |
| 110 P. cod | | 03 Bled | 472 | | 41 Fish meal | | | | |
| 270 Pollock | | 01 Whole | 26 | | 41 Fish meal | | | | |
| 122 Flathead sole | | 01 Whole | 13 | | 41 Fish meal | | | | |
| Discards | | | | | | | | | |
| 121 Arrow fldr | | 01 Whole | 600 | | 98 Disc atsea | | | | |
| 160 Sculpin | | 01 Whole | 300 | | 98 Disc atsea | | | | |
| 122 Flathead sole | | 01 Whole | 1,500 | | 98 Disc atsea | | | | |
| 123 Rock sole | | 01 Whole | 1,800 | | 98 Disc atsea | | | | |
| 200 Halibut | | 01 Whole | | 20 | 98 Disc atsea | | | | |
| 940 Hair crab | | 01 Whole | 20 | | 98 Disc atsea | | | | |
| 141 POP | | 01 Whole | 5 | | 98 Disc atsea | | | | |
| 700 Skate | | 01 Whole | 350 | | 98 Disc atsea | | | | |

Total:

| Taxes | Rate | Amount |
|--------------|------|--------|
| Landings Tax | | |
| AFA Fee | | |
| Other | | |
| Total | | |

I HEREBY ATTEST THAT THESE FISH WERE CAUGHT IN COMPLIANCE WITH ADF&G REGULATIONS.

Permit Holder's Signature _____

Fish Received by _____ Date _____

Landing Report ID: 333505

CFEC Serial Number: 618098

P. cod Round Weight: 132,447

Arrow fldr Discard Round Weight: 600

Flathead sole Round Weight: 13

Flathead sole Discard Round Weight: 1,500

Rock sole Discard Round Weight: 1,800

Rex sole Round Weight: 201

POP Discard Round Weight: 5

Pollock Round Weight: 278

Octopus Round Weight: 51

Sculpin Discard Round Weight: 300

Skate Discard Round Weight: 350

Hair crab Discard Round Weight: 20

Observer only

Total Round Weight: 132,990

ODDS Trip Number: 56706

ADFG only

Logbook

Observer

Interview

M7BG 11120G 1016 I NELSON CHRIS R 2023-08-24 21:42:55 E23 841551 Final Report Submitted

Figure 4-14: Example of a Catcher Vessel Offload Form and Corresponding Fish Ticket for Offload 10

This page intentionally left blank

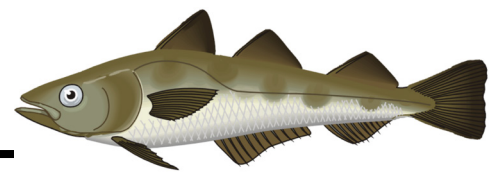

TRAWLER COMPOSITION SAMPLING

Table of Contents

| | |
|--|------|
| Sampling Design Guidelines | 5-2 |
| Selecting Hauls to Sample | 5-3 |
| Species Composition Sampling Guidelines | 5-3 |
| Preferred Sampling Method | 5-3 |
| Number of Samples per Sampled Haul | 5-3 |
| Sample Size Considerations | 5-4 |
| Sample Bias | 5-5 |
| Recognizing Potential Bias | 5-5 |
| Minimizing Sampling Bias by Sample Method | 5-7 |
| Non-Random Sampling Bias | 5-7 |
| Opportunistic Samples | 5-7 |
| Sampling Methods to Avoid | 5-7 |
| Random Sampling on Trawlers | 5-7 |
| Implementing Your Sample Design | 5-8 |
| Mechanics of Sampling on Catcher Vessels | 5-9 |
| Sampling from a Codend | 5-9 |
| Sampling Using a Checker Bin | 5-9 |
| Sampling Using the Conveyor Belt on a CV | 5-9 |
| Sampling from the Trawl Alley | 5-9 |
| Random Sampling on Catcher Vessels | 5-10 |
| Spatial Frames on Catcher Vessels | 5-10 |
| Systematic Sampling on Catcher Vessels | 5-11 |
| Systematic Sampling from a Codend or Conveyor Belt | 5-11 |
| Mechanics of Sampling on Catcher/Processors | 5-12 |
| Sample Collection After an Incline Belt on a CP | 5-13 |
| Sample Collection Off a Conveyor Belt | 5-14 |
| Random Sampling on Catcher/Processors | 5-14 |
| Systematic Sampling on Catcher Processors | 5-14 |
| Catcher Processor Sampling Without a Flow Scale | 5-15 |
| Addressing Challenging Sampling Situations on Catcher Processors | 5-17 |
| At-Sea Sample Sizes | 5-18 |
| Catch With High Species Diversity: Small Sample Sizes | 5-18 |
| Catch With Low Species Diversity: Large Sample Sizes | 5-19 |
| Determining Weight of Large Samples by Flow Scale Readout | 5-19 |
| Clean Catches With One or Two Predominant Species | 5-19 |
| Subsampling for Two Predominant Species | 5-20 |
| If You Can't Meet the Minimum Sample Size Requirements | 5-21 |
| Flow Scale - MCP Scale Weight Comparison Form | 5-21 |
| Processing Your At-Sea Samples | 5-22 |
| Identification of Sampled Species | 5-22 |
| Accounting for Pre-Sorted Samples | 5-22 |
| Counting and Weighing Sample Items | 5-23 |
| Subset Sampling for Species Identification on Trawlers | 5-24 |
| Seabirds | 5-25 |
| Decomposed Fish, Damaged Fish, and Miscellaneous Items | 5-25 |
| Corals | 5-26 |
| Combined Samples | 5-26 |
| Marine Mammals and Large Items | 5-26 |
| Crab Pots | 5-26 |
| Crab in the BSAI Pollock Fishery | 5-26 |

TRAWLER COMPOSITION SAMPLING : PRIORITIES

| | |
|--|------|
| Estimating Percent Retained | 5-27 |
| Salmon in the Shoreside Pollock Fishery | 5-28 |
| Pollock Catcher Vessel Offload: Salmon Monitoring Requirements | 5-28 |
| Bering Sea Pollock Catcher Vessels | 5-29 |
| BS Pollock Offload Salmon Retention Count | 5-29 |
| Pre-Offload Meetings with Industry | 5-30 |
| BS Relief Guidelines for Working with the Plant Observer | 5-30 |
| Gulf of Alaska Pollock Catcher Vessels | 5-31 |
| GOA Vessel Observer Offload Salmon Retention Count | 5-31 |
| GOA Pollock Vessels Delivering to AFA Plants | 5-34 |
| Catcher Vessels Acting As Tenders | 5-35 |
| Observers Delivering to Motherships | 5-35 |
| Salmon in the Catcher Processor Pollock Fishery | 5-35 |
| Halibut in the Trawl CP and Mothership Non-Pollock Fisheries | 5-36 |
| Limited Access Privilege Program Fisheries | 5-40 |
| GOA Shoreside Trawl Fisheries | 5-41 |
| GOA Trawl Catcher Vessels: Determining Target Species | 5-42 |
| Sampling on Trawl Catcher Vessels in the GOA Rockfish Fishery.. . . . | 5-42 |
| Deck Form Instructions. | 5-43 |
| Halibut Deck Sort Data Form Instructions | 5-45 |
| Paper Form Instructions | 5-46 |
| Trawl Deck Form Examples | 5-46 |

PRIORITIES

- Your safety!
- Collect data and specimens from marine mammal and endangered seabird mortalities.
- Rehabilitate ESA-listed seabird species.
- Collect salmon retention data.
- Sample for species composition.
- Collect halibut deck sort samples and viability data.
- Send data to the Observer Program as directed (see “Sending Data” on page 2-39).
- Monitor for marine mammals.
- Document any compliance concerns.
- Measure and assess viabilities of Pacific Halibut.
- Measure and determine the sex of other prohibited species.
- Collect biological data from the appropriate species.
- Collect sexed length frequencies from the appropriate species.
- Complete research projects.

INTRODUCTION

Species composition sampling is high on the Observer Program’s priority list, and more time is spent on this task than any other. Species composition sampling is the collection of catch samples from a selected haul.

Fisheries managers base their assessment of catch rate on the results of your species composition samples. The data you collect are used to monitor allowable harvest and are used by scientists for population analysis and stock assessment.

SAMPLING DESIGN GUIDELINES

One of the first things to do when you arrive on a vessel is inspect your sampling station and determine a sampling design. Refer to “Becoming Familiar with Your Vessel” on page 2-4 and “Sample Station Requirements” on page 2-32 for items to look for in a sampling station. When defining a sampling design you must consider:

- Access to the entire target population.
- Where to collect your sample.
- What sampling biases could occur in your collection and how to minimize them.
- How to collect your sample.
- Will your sample population equal target population?

- How many samples you will be able to collect.
- What size sample unit you will be able to collect.
- How much storage space is available.
- How you will process your sample.

Draw a diagram of your sampling station in your logbook. In the Daily Notes section, describe the random sample design you intend to use. *Your sample design will be put to the test once you start sampling, and you may find that you need to make some changes to it.* When you have settled on a random sample design fill out a Sample Design Detail section in your logbook. On this form, describe your sampling design in detail, addressing each of the above topics. Day to day minor adjustments to the random sample design can be documented in the Daily Notes section of your logbook. Refer to your logbook for an example.

You may alter your design as you gain experience, become aware of biases, or as the species composition or target fishery changes. Document all changes in the Daily Notes section of your logbook and explain why they were made. Random sample designs for trawlers are discussed in detail starting on page 5-7. If you have problems creating or implementing a sampling design contact your inseason advisor or other Observer Program staff member.

Selecting Hauls to Sample

Observers on vessels that retrieve three or fewer hauls per day, or that only fish for part of the day, are expected to sample all hauls. *Observers on pollock catcher vessels and on vessels that have two or more observers are expected to sample all hauls.*

It may take one or two hauls to develop a rhythm and become used to vessel operations. Inexperienced observers should be especially cautious until they are familiar with the way catch is handled. You may need to reduce your sampling effort for the first few hauls (fewer and/or smaller samples). Document your methods and the reasons for the reduced sampling effort in your Daily Notes. If you are unable to sample a haul for any reason, you must document the circumstances in your logbook. After only a few hauls you will be familiar with the catch handling process and should be able to decide on a sampling design that is right for your vessel and fishery.



Be sure to discuss safe deck practices, haulback procedures and potential sampling needs with the vessel before fishing begins!

If it is not possible to sample all hauls brought aboard the vessel, you must use either the RST, RBT, or both to determine hauls from which to collect species composition samples. Please refer to “How to Use the RST” on page 2-19 for instructions on using the RST and refer to “How to Use the RBT” on page 2-20 for instructions on using the RBT. Consult NMFS staff if you frequently use them together as your sampling effort for that vessel will be low. *Please note that using the RST and RBT together is rare on trawl vessels.*

SPECIES COMPOSITION SAMPLING GUIDELINES

The sampling methods you are able to employ will depend greatly on vessel and fishery related factors such as: vessel size, gear, hauling and processing practices, crew assistance, catch diversity, and catch size. There are some guidelines and sampling methodologies that you should try to follow and maintain. These are discussed below.

Preferred Sampling Method

There are several sampling methods available to you for collecting samples. These are covered in “Random Sampling on Trawlers” on page 5-7. As discussed in the section “Introduction to Sampling Theory” on page 2-22, the preferred method is systematic random.

The target population on a trawler is always everything caught in the codend. To achieve systematic random sampling on trawlers, the target population must be divided into sample units of equal size. Choosing units to sample systematically results in samples that are equally spaced throughout the entire haul, thus representing the population more fairly.



Fewer, smaller samples make it less certain that the samples are representative. For this reason, several larger samples within a haul are preferred.

Number of Samples per Sampled Haul

You should take as many individual samples within a haul as feasibly possible. At least three discrete composition samples of approximately equal size are required for every sampled haul to allow data users to assess sample

variance. *More than three samples is always preferred.* If you are not able to collect multiple samples on your trawl vessel, you must document the circumstances in your observer logbook Daily Notes pages, and check in with the Observer Program for assistance.

Sample Size Considerations

Samples within a haul must be approximately equal in size to each other and as large as possible. Taking multiple random samples and making these samples as large as possible is a compromise between the best case scenario and single small samples. Refer to “At-Sea Sample Sizes” on page 5-18 for specific information regarding sample unit size options by trawl fishery.

On trawlers, the size of your sample units will be influenced by several things, among them:

- the diversity of the catch.
- the space available to you for storing fish from your sample.
- the time you have available to sort fish.
- crew ability to help sort or slow processing to accommodate sorting.
- whether or not there is a flow scale in use.

When considering how large you can make your samples for any given haul, follow these guidelines:

1. Strive to collect random samples using a random sample design (see “Random Sampling on Trawlers” on page 5-7). When this is not possible, document the reasons in your logbook.
2. Random samples taken within a haul should be of approximately equal size. Catch diversity will be a primary factor in sample size determination. In order to achieve similar sample sizes over the course of one sampled haul, tailor sample size to accommodate the most diverse portion of the catch



Remember: it is just as biased to increase sample sizes within a haul because it has become clean as it is to cut sampling short because the catch has become dirty!

3. Allocate your time appropriately. Maximize sample size based on the amount of time you can afford per haul, keeping in mind all the other sampling related duties you are required to perform. Keep to the RST

and/or RBT schedule. The size of any given sample will be additionally influenced by the following factors:

- **General Health:** The amount of time and energy you can spend on composition sampling will be affected by your general health. Most factory vessels operating 24-hours per day will carry two observers and you will each work a 12-hour shift. If you are the sole observer on a factory vessel, you may use the RST and/or RBT which will reduce the number of hauls you need to sample. You may need to reduce sample size to keep up with your other duties, recover from seasickness, or recover from illness.
- **Size of Hauls:** Consider the amount of catch per haul when deciding on a sample size. In some fisheries, 100 mt codends taking 4-8 hours to process are not uncommon. Weighing and counting everything in a haul this size is difficult due to time constraints and high bycatch.
- **Species Diversity:** It takes longer to sample a “dirty” haul (one with high species diversity) than it does to sample a “clean” haul (one with only one or two predominant species). In fisheries with a lot of bycatch, you will need to reduce your sample size in order to process your samples in a reasonable amount of time. Conversely, in clean fisheries you may be able to take much larger samples.

4. You must sample from unsorted catch and you must be present to sort, or directly supervise the sorting of, all fish in your sample. If you see or suspect that you are



missing individuals in your sample, reduce your sample size and/or change your sampling method. *You must be certain you are accounting for all of the fish in your sample.*

5. With the exception of the offload salmon retention count, you cannot selectively sample for any one species. *Every species that lands in a sample must be accounted for on the species composition data form.* The species you will encounter can be categorized

into four groups:

- **Prohibited species:** The five prohibited species groups are: the king crab group, the Tanner crab group, the salmon group, Pacific Halibut, and Pacific Herring.
- **Non-prohibited species:** This is made up of two groups: bycatch species and target species.
- **Seabirds:** This category encompasses all bird species, both migratory and resident, found in Alaskan waters.
- **Miscellaneous:** This is made up of invertebrates, garbage, non-allocated species and essentially anything not described above.

SAMPLE BIAS

The goal of the Observer Program is to obtain unbiased samples of the harvested catch in each target fishery. Bias can be minimized when sampling by employing appropriate sampling methods, sampling from randomly chosen sample units, and by accounting for other recognized biasing mechanisms.

Recognizing Potential Bias

The vessels you will be working on are not research vessels and most sampling situations you encounter will not be ideal. Assess your collection site for possible biases, document what they are, and how you attempt to avoid them. Some specific sampling biases you need to look for are discussed below.

Deliberate Interference

Federal Regulation 50 CFR 679.7 states that it is unlawful to “interfere with or bias the sampling procedure employed by an observer, including physical, mechanical, or the sorting or discarding of catch before sampling”. In some fisheries it is advantageous for the vessel to intentionally remove certain species prior to sampling. The removal of organisms prior to catch sampling is called “pre-sorting”. This practice may lead to bias in your samples by misrepresenting the true bycatch rate for these species.

Refer to page 20-2 for the steps to take if you suspect deliberate interference with sampling. There are several ways vessel personnel could sort out individual organisms prior to your sample, so watch for the following:

- **Dumping undesirable catch overboard:** Vessel crew may dump an entire codend overboard, or a portion of one, because of high bycatch levels. This biases your data because you do not have access to the entire catch. Ask the captain not to discard fish from the codend until you have had the opportunity to sample. On factory vessels, this may mean you reduce your sample size and sample on deck. If the captain will not comply, note this in your logbook. If the vessel regularly dumps codends before you can sample, contact your inseason advisor or an Observer Program staff member. Enter code 6 on the VHF for vessel type if the entire catch on a Catcher Vessel is dumped overboard (see page 4-17).
- **Removing and discarding unwanted species:** Vessels may have crew members in the trawl alley, fish bin, or on the sorting line in order to sort out fish. This activity can potentially bias your sample, depending on when it occurs. If organisms are removed prior to you taking a sample, such that they never had the opportunity to land in your sample, your samples are potentially biased. Inform the captain or factory manager that you must have access to unsorted catch. To the best of your ability, quantify the amount of fish removed each time this occurs and document this information on your Deck Form and in the Daily Notes section of your observer logbook. Notify the Observer Program of pre-sorting problems as soon as possible. If you feel this may make your position on the vessel unworkable, you can ask NMFS staff not to confront vessel personnel until you have disembarked.
- **Crewmen in the bins:** The setup of some non-AFA groundfish factory vessels is such that it is necessary for a crew member to push the fish out of the bin door or onto a conveyor belt. This is a potential problem because they can push certain species away from the conveyor belt where you are sampling, or hold these species until you are finished sampling. Currently, on limited access non-AFA groundfish vessels, there are regulations that restrict crew activity in the bins. Specifically, observers must be able to view all activities inside the bins. For details on these regulations, see “Regulations Specific to Non-AFA Trawl Catcher/Processors Fishing in the BSAI” on page 20-17. On other vessels with bins, there are ways to deal with the problem of crewmen in the bins. These are listed below. If the problem continues, notify the Observer Program or NMFS Enforcement.

1. Ask the crew member to step out of the bin when you

are sampling.

2. Collect randomly selected samples.
3. Watch the crew in the bin before, during, and after you collect your sample.
4. Watch the sorting line to see if concentrations of specific species increase when you are not sampling.
5. Look for halibut and/or salmon being held in the bin. Some boats have areas in the bin where fish can be stored until you leave the factory.
6. Speak with the individual responsible, then talk with the factory managers and the captain. Document these discussions in your Daily Notes.

• **Large animal removal on deck:**

Although presorting may be a violation, removing large animals on deck to prevent them from entering the factory or RSW tanks is a common practice, and sometimes unavoidable. *You must*

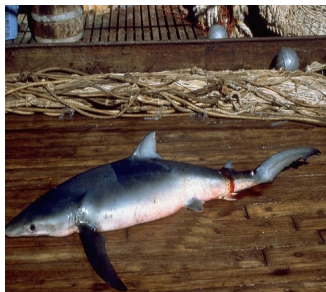

ask to be notified if this occurs. Depending on the timing of the removal, you may need to include the animals in your species composition data for that haul (see “Accounting for Pre-Sorted Samples” on page 5-22).



Inform the captain the first time pre-sorting occurs. Document ALL observations, occurrences, and conversations you have regarding this problem!

Mechanical Biases

In addition to deliberate biasing actions by vessel crew, there are mechanical biases. In order to determine if mechanical bias is affecting your sample population, you must understand how fish flow from the codend to your sample collection point. When assessing fish flow, specifically watch for:

- **Grates:** These sort out large organisms such as sharks, large skates, and large halibut when fish are dumped into the live tanks. Look for grates on deck hatches and bin doors from the deck to the live tank. Count and/or weigh anything you see mechanically pre-sorted from

the catch and include this in your species composition data as a discrete sample (see “Accounting for Pre-Sorted Samples” on page 5-22).

- **Small openings:** Small openings can exclude large fish from your sample. Watch for exclusion of large fish at the hydraulic door allowing fish to move from the fish bin to the factory processing belts. Often the crew will keep this door open just enough to allow a steady flow of fish. If the door is not open enough to allow large individuals to pass through, the sample you collect is potentially biased. If you are collecting fish from a trawl alley through an access point in the trawl alley wall (for example by lifting a bin board or gate), make sure the opening is big enough to allow the larger organisms in the haul the same access into your sample as the smaller ones.

- **Inaccessible bins, tanks, or belts:** These will prevent you from setting up a random sampling design because the fish in the inaccessible bin, tank or belt will not have a chance to fall into your sample. While there is little you can do to solve this problem, you should try to randomize your collection as much as possible. Make note of the sampling biases and how you deal with them in your log book.

- **Conveyor belts:** If a conveyor belt is running too fast or too deep with fish, it is difficult to see and sort by catch that passes by you. You must be able to account for all individuals in your sample! Ask the crew to slow the belt and run the fish one layer deep. If the vessel crew will not comply, or if you are still unable to sort bycatch from the sample, note this in your logbook and take smaller samples for species composition (e.g., sample sizes of several hundred kilograms as opposed to several tons).

- **Incline belts:** Incline belts can affect a sample in many different ways. Some are steep with small tines that don't accommodate large fish. Others allow large fish to move up, but at a different rate than the smaller fish. When this occurs and you are not systematically sampling the entire catch, some fish have less of a chance of falling into your sample. To alleviate this bias, try to take your sample before the incline belt. If you cannot avoid the incline belt, be sure to clear all fish in front of the incline before and after you collect your sample. Fish that did not make it up the incline belt during your

sample collection period must be taken from the base of the incline belt and be included in your sample.

- **Pumping the net:** There are a few vessels that pump fish from their codend into the hold. These vessels use transfer tubes that sort out large individuals. There is no way to account for organisms sorted out in this way. In your logbook, make note of the fact the vessel transfers fish by pump. Include the diameter of the pump tube and the size of the largest organism you observed in the catch. Sample for species composition as if this were not a factor.

Minimizing Sampling Bias by Sample Method

The sampling design you use should take into account any potential biases and minimize their effects. Three ways to achieve this are:

- **Use random sampling:** By using a random sample design, you will eliminate subjectivity and ensure that every member of the population has an equal probability of occurring in your sample.
- **Maximize sample size:** Weighing and counting everything in the catch is the best way to obtain information about the population, since the “sample” size in this scenario is the entire catch. In most cases it will not be possible to sample the entire catch; smaller samples will have to suffice. Although larger random samples are preferred, small samples are perfectly viable when they are randomly collected. If you have to choose between large, non-random (potentially biased) samples and smaller, random (unbiased) samples, smaller random samples are preferred.
- **Take multiple samples:** Take as many samples as you can. Your sample units must be of relatively equal size.

Non-Random Sampling Bias

When samples are not collected randomly, fisheries managers cannot assume they are unbiased or use statistical methods of analysis on these data, as they can with random samples. If you determine that you cannot use a random sample design on your vessel, you must document the reasons in your logbook and use a non-random (or “opportunistic”) method to collect samples.

Opportunistic Samples

These are samples taken either (1) without pre-selecting when, or from where, you are going to sample, or (2) from the only accessible portion of the catch.

The following are examples of opportunistic sampling:

- Taking subsequent samples immediately after you have finished sorting the previous sample regardless of how long it took to sort that sample.
- Sampling from only one area of the codend or deck because all other areas are inaccessible.
- Taking your sample at the very beginning of a haul because the haul is small and you are worried you are not going to obtain a reasonably sized sample if you don't take it right away.

In each one of these examples, not every fish in the population has an equal chance of ending up in your sample; the sampling is opportunistic and potentially biased.

Due to vessel constraints or safety considerations, random sample methods are not possible on some vessels. In these situations, opportunistic samples will have to suffice. If you use opportunistic sampling techniques, document the reasons why you had to do so in your observer log book.

Sampling Methods to Avoid

Sampling methods to avoid are ones in which you make a decision on when or where to sample based on perceived composition. Never take a sample from a particular area of the haul because you feel the organisms in that area have not been fairly represented in your sample. For example, if you see a rare species while the haul is being dumped, but do not get any in your sample, it is not appropriate to select an additional portion to sample just because it contains that rare species.

RANDOM SAMPLING ON TRAWLERS

Random sample designs are not used when every sampling unit can be collected. Sampling an entire haul is a true census of the population, and is not subject to sample bias.

In order to take random samples from a population, you need to establish a framework that ensures all individuals have an equal probability to be included in your sample. A random sample design eliminates subjectivity regarding

when to collect your sample. Without a defined, documented sampling design, your samples cannot be considered random. If you have to abort or alter a sample design during the sampling of a haul, document in detail the circumstances in your observer logbook Daily Notes. For further detail regarding sampling designs, see “Introduction to Sampling Theory” on page 2-22. Also refer to “Addressing Challenging Sampling Situations on Catcher Processors” on page 5-17 or “Addressing Challenging Sampling Situations on Catcher Vessels” on page 5-12.

Population and Sample Units

On a trawl vessel, the target population for species composition is all the individuals caught in the codend. You will typically use a visual estimate of the catch to define your sample units and select a sample design. This estimate of total catch is often referred to as the “hail weight”.

The spatial sample units will be defined based on when the population is available to you:

- When the entire population is available at one time (e.g., the codend is dumped out on deck), spatial units may be established by visually creating a grid of the fish in the trawl alley. Bin boards, bin doors, deck markings, and any other reference points can be used to help you define the sampling grid.
- When the entire population is available over time (e.g., dumped into a live tank or run across a factory conveyor belt) the spatial sampling units may be defined in different ways based on your vessel type. On a catcher trawler, you will define the sample units before the fish are dumped into a live tank by estimating sample units of weight and using time to approximate when the sample unit is available to be collected. If the catcher vessel is equipped with a conveyor belt, you can also use time to approximate when the selected sampling unit is available on the belt. On a catcher processor or mothership, you will most likely define sample units based on the catch hail weight, then use the vessel’s flow scale to determine when to collect your samples and obtain sample size.

Random sample designs are not used when every sampling unit can be collected.

Implementing Your Sample Design

The observer program recognizes that collecting data on a commercial vessel can be very challenging. The sampling directions provided in this manual are guidelines that when followed will ensure your data collections are consistent and useful to the data users.

Selecting the Starting Unit

For a systematic sample you must select a starting unit for your sample frame once you have set up your sample design (remember that for a simple random design you select only one unit).

- Example 1: You have 10 units of 1000 kg and you randomly select unit 2 as your starting unit; this means you should sample from 1000-2000kg.

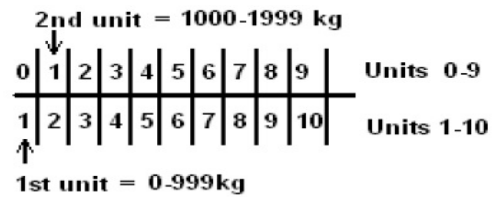

- Example 2: If you have 60 units of 100 kg and randomly select unit 33, you should sample from 3200-3300kg.

If your units are numbered 1 through n and you multiply your selected unit number by the unit size the resultant number is actually the end of the unit you need to sample. This would bias your samples by not including the first unit as one to be sampled and the first part of a haul would not be sampled. An easy way to correct this is to start your random number selection at 0. If you have 10 units, instead of selecting 1-10, randomly select a number between 0 and 9. Using example 1 above the selection of “1” would give you your actual starting weight of 1000 kg (1 x 1000 kg). If you have 60 units, instead of selecting 1-60, randomly select a number between 0 and 59. Using example 2 above, the selection of “32” would give you your actual starting weight of 3200 kg (32 x 100kg).

Collecting Your Sample Unit

Over a few days of sampling it is expected that you will be able to figure out the “normal” range of variation within your system and continue to bring your collections more in line with your sample designs. Similarly, your sample size will rarely be the exactly designated weight. For example, it is acceptable if 150 kg is intended for your sample size and after collecting all the fish into your

containers, the total weight is actually 167 kg or perhaps 125 kg. Again, over time you will develop a “normal” range for your sample size.

These variations in sample size and sample collection start points are normal variations due to the logistical challenges on commercial fishing vessels.

MECHANICS OF SAMPLING ON CATCHER VESSELS

Obtaining random samples on catcher vessels takes creativity and a thorough assessment of how the catch is processed. Catcher boats usually handle their codends in one of two ways:

1. The catch is dumped directly down hatches into the RSW tanks. This is typical on pollock vessels.
2. The entire catch is dumped into the trawl alley and the crew sorts retained fish into RSW tanks. This is typical on Pacific Cod, flatfish, and rockfish vessels.

Sampling from a Codend

If your vessel dumps unsorted catch directly into the RSW tanks, you may have to fill your baskets by catching the fish as they are flowing from the net to the deck, or from the deck into



RSW tanks. If you choose this method, any large fish that hit your basket are included in your sample, even if they don't fit in your basket. You may need assistance from a crew member to hold your basket under the flow of fish.



Always consider your safety when choosing a collection site. Do not position yourself under the codend when taking a sample!

Sampling Using a Checker Bin

If your vessel has checker bins available (checker bins are compartments on either side of the trawl alley), you can divert unsorted catch into them by lifting a bin board. The crew may also be able to dump some of the codend directly into the bins. Depending on the size of samples collected, weigh all the fish, or use random methods to further reduce the sample unit within each bin.

Taking samples from different bins minimizes bias because samples are not coming from only one area of the codend. On some vessels, crew use checker bins to store gear such as extra codends, webbing or chains. If you do not have access to all bins, document in your logbook what bins you can and cannot use to contain samples. If you can only sample from one bin, you may be able to implement a systematic sample design (see page 5-11) to sample over the course of the haul and thereby minimize bias.

Sampling Using the Conveyor Belt on a CV

Crew may run fish across a conveyor, sorting fish as they go into the RSW tank, or for distribution into various RSW tanks. This always requires incline belts carrying fish out of the trawl alley. On these vessels, the crew typically sorts from a horizontal belt located directly after the incline belt. Composition samples can be taken from the sorting belt, just prior to crew sorting activities. Because there is an incline belt, you must be aware of any items presorted by this feature and account for them using the methods discussed under “Mechanical Biases” on page 5-6. In these sampling scenarios, you must also be particularly watchful of intentional or unintentional crew pre-sorting. If you determine that there is mechanical bias from the incline belt or presorting from the trawl alley you will need to collect your samples from the trawl alley.

Sampling from the Trawl Alley

If catch is dumped onto the trawl deck, take steps to prevent size sorting when selecting your sample. Do not take a sample by shoveling fish into your baskets, by hand selecting



fish, or by using your basket as a scoop. Instead, isolate an area from which to collect all fish. Another way to isolate a sample is to ask the vessel for extra bin boards; these wooden planks can be used to cordon off an area of the trawl area where you can collect fish for the sample.

In the Pacific Cod, rockfish, and flatfish fisheries, the crew will want to start sorting the catch immediately. You must be sure to take your sample before any active sorting by crew or machines happens.



Not looking at the fish while you grab, gaff, or shovel them does not eliminate bias! Fish collected in this manner are potentially size biased if you do not have a random sampling design in place for selecting individual fish.

RANDOM SAMPLING ON CATCHER VESSELS

Random sampling on catcher vessels can be very challenging. Try the following methods and document your results.

Make sure that you have explored systematic random sampling from a spatial frame as an option before resorting to simple random sampling from a spatial frame. Systematic sampling methods are discussed beginning on page 5-11.

If you determine that sampling using a random design is not possible, you must document your reasons and give an explanation of the sampling methods used.

To sample effectively you will need to 1) determine the size of sample you can take, and 2) estimate how long it will take to process this sized sample (this will help you determine how many units you can realistically sample).

Spatial Frames on Catcher Vessels

Spatial frames may work on vessels which dump their entire codend onto the trawl alley before sorting retained species into RSW tanks. One way to create a spatial sample frame is to establish a “grid” pattern on the trawl alley. Mark out a grid pattern or use reference marks such as trawl alley boards, hatch, or scupper openings, etc. Number the grid sections and use the Random Number Table (RNT) on A-21, or other method, to pick areas from which to take samples. If you cannot collect all fish from within a grid (unit), reduce the size of the sampling unit until you can (see Figure 5-1). You should not enter the trawl alley to collect your sample until your grid is the size of the spatial unit you intend to collect.

If your vessel has several checker bins available for use, it may be possible to implement another type of spatial design. If access to catch is limited and it is unsafe to enter the trawl alley, lifting the checker bin boards allows the fish within the selected sample unit to flow from the trawl alley into the bins. Divide your target population into sampling units as usual. However you

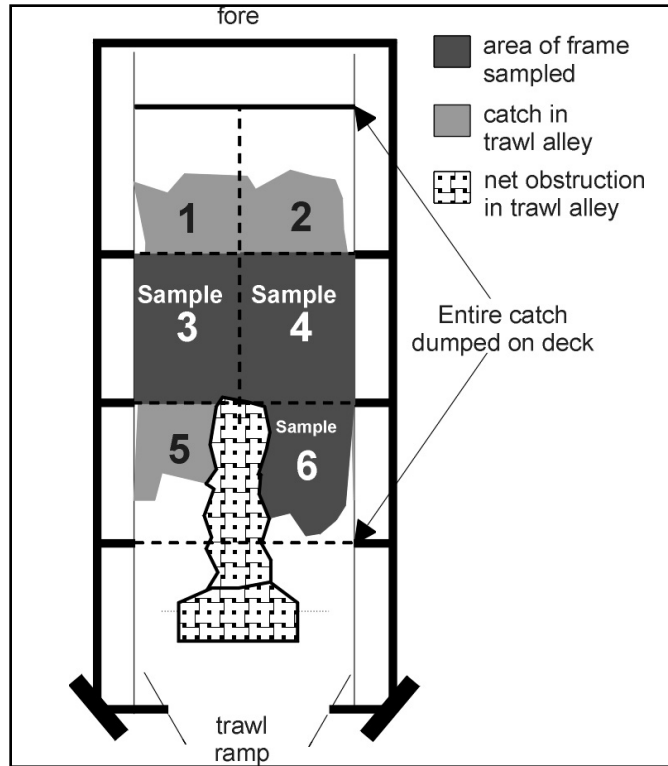

Figure 5-1: Spatial Design Using Trawl Alley

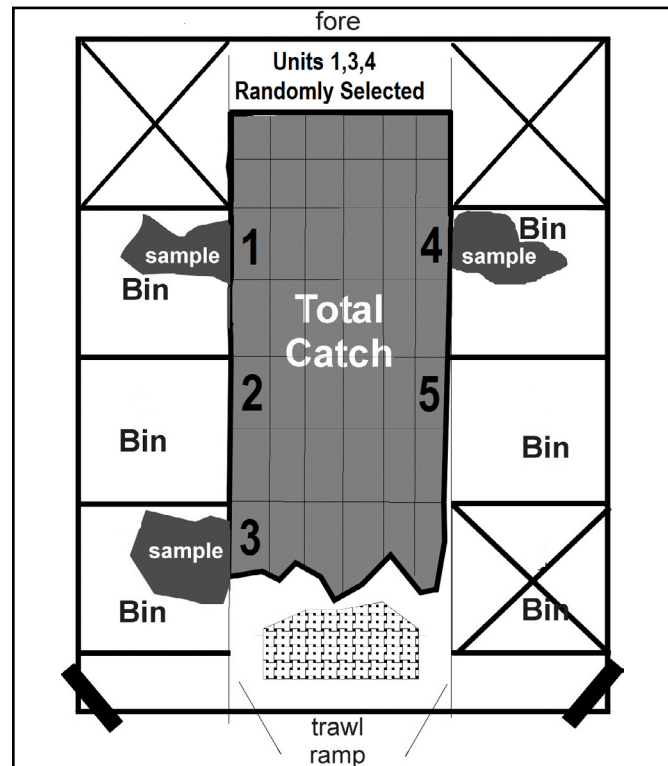

Figure 5-2: Spatial Design Using Checker bins

can only access the fish in front of the checker bins. Randomly select available sample units using a simple random sample (SRS) or systematic (SYS) design. Lift the appropriate bin board next to your sample unit and let the sample unit flow into the bin. You will need to do a visual estimate of the sample size you are collecting.

In the Figure 5-2 example, fish were allowed to flow into the selected bins when the bin boards were lifted. This design yielded three species composition samples for the haul.

Simple Random Samples from the Codend or Conveyor Belt

Use this method to randomly select a single sample unit from your frame. Complete the following steps:

1. Divide the estimated haul size by the intended size of your sample unit. Number the resulting sampling units sequentially.
2. Use the RNT or other method to randomly select a sample unit “*n*” from sample frame. This resulting number corresponds to the sampling unit you will sample.
3. Estimate the time you will collect your spatial unit using steps 4-6 described below in “Systematic Sampling from a Codend or Conveyor Belt”.

You always want to try to get multiple samples with in a haul, but if you can't, make sure that the unit you use for your one sample is randomly selected! Document your methods and any possible biases in your log book.

Systematic Sampling on Catcher Vessels

Systematic sampling involves taking a sample during every “*Nth*” sample unit, defined as a space interval. Spatial units are taken systematically throughout the haul from a spatial frame. Unsorted catch is more likely to be available over time than over space on these vessels. Vessels falling into this category are those that dump their catch directly into a hold, have incline belts out of the trawl alley or run fish into tanks from a below-deck sorting line.

Systematic Sampling from a Codend or Conveyor Belt

Systematic sampling can be particularly useful on bottom trawl catcher vessels with incline belts carrying fish out of the trawl alley and on vessels that dump fish directly

from the codend into the RSW tanks. By using time to estimate when you will collect your spatial sample unit, samples may be collected systematically throughout the sample population. This method is referred to within the Observer Program as using “*time as a proxy*”.

To create the spatial sample frame, do the following:

1. Divide the estimated haul size by the intended size of your sample unit. Number the resulting sampling units sequentially.
2. Divide the number of sampling units in your frame by the number of samples you intend to take. This value represents your sample interval “*i*”.
3. Use the RNT or other method to randomly select a sample unit “*n*” from the first interval. This resulting number corresponds to the first sampling unit you will sample. Samples are taken at this randomly selected unit and every “*i*” units thereafter (see Figure 5-3). (Collect samples from the same unit “*n*” in each subsequent interval).

You will need to collect your spatial sample based on the estimated time when it will flow from the codend. Do the following to establish when to collect your spatial sample unit:

4. Estimate the time it will take to dump the entire catch into the RSW tanks.
5. Divide the total estimated time to move fish to the RSW tank by the number of sampling units established in step #1. This will give you your estimated time-per-sample unit. On most catcher vessels this will be only a few seconds, expressed as a decimal minute.
6. Multiply “*n*” (the sample unit you selected in step 3) by the estimated time-per-sample unit (the number in step 5). This random number represents the approximate time at which you will take the first sample.
7. Subsequent samples are taken at the same time within each sampling interval. Use the interval “*i*” established in step #2 multiplied by the time per sample unit from step #3. For example, if “*n*” is the 40th sampling unit and the time per sample is 0.5 minutes, your sampling interval would be 20 minutes (40 x 0.5). Another way to express this is to say you will collect samples from the same unit “*n*” in each subsequent interval.

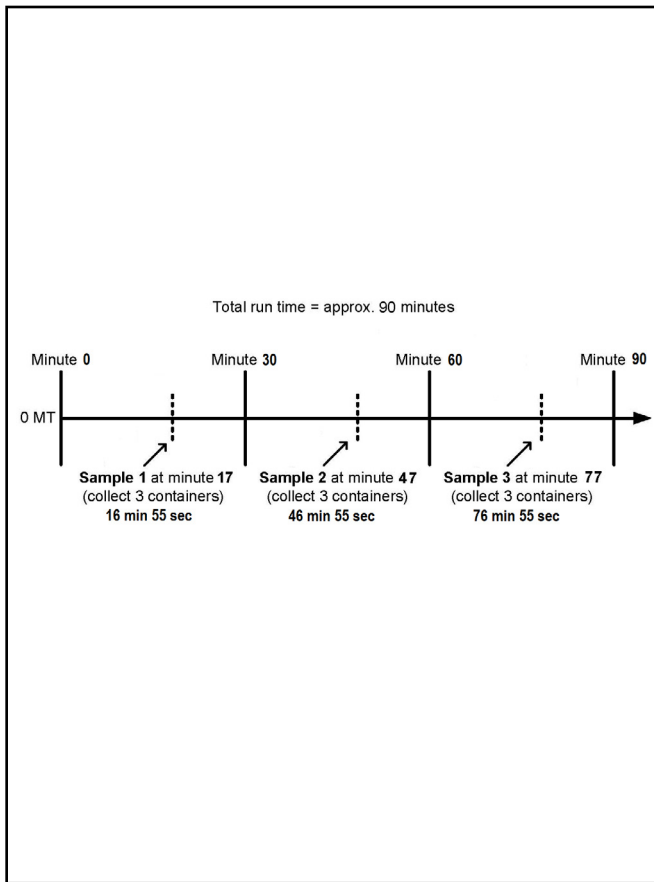

The observer is on a CV in the GOA (no flow scale). Fish are dumped in the trawl alley, then run up and over a belt for sorting from which the observer will sample. There is no mechanical sorting (observer has crew assist fish up the belt during sample collection). They have storage for 3 samples of 120 kg each (~3 baskets of fish). Haul size estimate = 14 tons. 14000 kg/120 kg units = 116.6 units, or 117 units. This was divided by 3, the number of samples the observer intended to take $117/3 = 39$ sample units per sample interval. A random unit (#22) was chosen within the resulting sampling interval of 39 sample units. To establish when to sample: Estimated sorting time = 90 minutes / 117 units = 0.769230769 minutes per sample unit. Sample unit #22 (1st unit of 120 kg) will be collected at ~16 minutes 55 seconds ($0.76923079 \times 22 = 16.92307691$ minutes; $60 \times 0.923 = 55.38$, or 55 seconds), with an interval of 30 minutes ($0.76923076 \times 39 = 30.00$). Because time is an approximate, if the sorting speed increases or decreases you must adjust your sample interval accordingly. Do your best to sample units 22, 61, and 100. If the captain underestimated the catch size then you must continue to sample at unit 139; $139 \times 0.76923079 = 106.923$ minutes. 60 seconds $\times 0.923 = 55$ seconds, so the 4th sample would be at 106 minutes 55 seconds.

Figure 5-3: Systematic Sampling from a Catcher Vessel Conveyor Belt Using Spatial Units

Refer to Figure 5-3 for further examples of using time to approximate when to collect your spatial unit from a conveyor belt. See Example 5-1 for an example of sampling from the flow of fish in the trawl alley using time to approximate the collection of your spatial unit.

Record each of these samples as discrete samples for the haul. If the vessel dumps fish rapidly, you may need to adjust your time to collect your sample unit. For example: If the estimate to dump was 40 minutes but it looks like it will take only 20 minutes, then reduce your interval by the amount of time you feel is appropriate to collect your intended selected sample units. Do your best to track times when fish are not flowing and do not include this when implementing your design. Remember that the spatial sample is based only on when the vessel is actually dumping fish from the codend.

You may also set up a systematic sampling design with time as a proxy by using the Interval and Time Approximation Tables on A-68. These tables will help you determine the sampling interval “i” and the approximate time to collect your samples.

Addressing Challenging Sampling Situations on Catcher Vessels

On rare occasions you may not be able to sample the entire originally chosen sample unit or be able to follow your intended sample design. If the original sample unit or design cannot be followed continue to sample and document the circumstances in your daily notes. Use each haul as a chance to improve sampling for the next haul and adjust your design accordingly. See “Documenting Sample Design Constraints or Problems” on page 2-26 for common sample challenge scenarios. Document why you were not able to follow the design in your daily notes. Adjust your sample design on subsequent hauls as needed. Record the sample design code and sample unit type on the Observer Haul Form that best describes the method you used to sample.

MECHANICS OF SAMPLING ON CATCHER/PROCESSORS

Sampling on a catcher processor or mothership usually takes place in the factory, from a conveyor belt. To minimize bias, the sample collection point should be prior to all sorting activities. Usually, the closer you are to where the catch exits the bin or tank, the less chance any mechanical or crew sorting can occur. If your sample collection point choices are limited, take steps to eliminate sample bias from mechanical size sorters, size sorting incline belts, and/or pumps located prior to the collection site.

The captain on your pollock catcher boat gives you a haul weight of 80 metric tons. Given storage space and your method for sample collection from the flow of fish, you decide to setup your sample frame using 100 kg sample units. **Three samples will be collected.** 80000 kg/100 kg unit = 800 spatial units (of 100 kg each). $800 \text{ units}/3$ (number of samples to collect) = 266.66666 units per sampling interval, rounded to 267 units. Using the RNT you select a starting unit between 0-266. You randomly select 223 as your start unit. Sample 2 will be unit 490 and sample 3 at unit 757.

In order to estimate when you will be collecting your sample, divide the estimated dumping time by the number of units in the haul. $35 \text{ minutes}/800 \text{ units} = 0.04375 \text{ minutes per unit}$.

Sample #1 will be at unit 223 at 9 minutes and 45 seconds. (Unit 223 X 0.04375 min/unit = 9.75625 minutes, and $0.75625 \times 60 = 45.375 \text{ seconds}$).

Sample #2 will be available at approximately 21 minutes and 26 seconds ($490 \times 0.04375 \text{ min/unit} = 21.4375 \text{ minutes}$ and $0.4375 \times 60 = 26.25 \text{ seconds}$).

Sample #3 will be at approximately 33 minutes and 7 seconds ($757 \times 0.04375 \text{ min/unit} = 33.11875 \text{ minutes}$ and $0.11875 \times 60 = 7.125 \text{ seconds}$). There is plenty of space on deck to store samples separately from each other, and the collection process is relatively straight forward.

For larger or smaller hauls you must design a new frame, adjusting the number of sample units and the interval each time the haul estimate changes. Sometimes, the haul may get dumped faster than you anticipated, and you will need to adjust your interval to capture the selected sample units.

Example 5-1 Systematic Sampling from the Codend flow of fish Using Spatial Units

Collecting Your Sample Unit

It is understood by the Observer Program that you may not be able to begin or end a sample at the exact kilogram as outlined in your sampling design. For example, on your vessel you intend to collect 150 kilograms of fish per sample and have used this as the unit size to design your sample frame. The trough on your vessel holds about 800-1000 kg of fish. If your sample collection point is intended to begin at 5500kg, then you are expected to be in the factory and ready to begin the sample process when the flow scale reads about 4500kg (about a trough full of fish). At this point you should have the bleeder close the doors to the live tanks and then clear the trough and belts. If after clearing the belts the flow scale reads 5184 kg, it is appropriate to take your sample even though you are not at the exact weight designated by your sample design. Going over the desired sample unit collection point may also occur. The observer program recognizes that in situations like this any attempt to get closer to your designated collection unit will not improve the overall value of your sample.

Trawler Samples and Subsamples

On trawlers, you will always have samples, but you may not always have subsamples. Subsamples are only utilized on CP trawlers with flow scales and are taken in situations when there are *two* predominant species in the sample. Subsamples must come from within samples. To indicate this relationship in this manual's text, the term "*parent sample*" is used. For any *subsample*, the parent sample is the sample from which the subsample was taken. In the data, you will use a specific numbering convention to associate a subsample to the sample from which it came. *A more thorough discussion of subsamples and when to subsample can be found on page 5-20.*

Sample Collection After an Incline Belt on a CP

On many factory trawlers, fish exit a bin or live tank, fill up a trough, then travel up an incline belt before they reach a horizontal sorting belt. To minimize the bias inherent with incline belts, clear the trough and incline belt of fish before taking the sample. If you can, fill the trough with just your sample fish and run this entire amount into your collection containers. Make sure when sample fish are being allowed into the trough, that the hydraulic door from the fish bin is opened enough to mitigate size biasing.

Sometimes it is too difficult to control the quantity of fish going into a cleared trough. If this is the case, have the crew do the following before you take your sample:

1. Close the hydraulic door to the live tank.
2. Clear the trough and incline belt.
3. Open the hydraulic door to the live tank and begin running fish as they would normally.

As you collect the sample from this flow of fish, watch for any organisms that obviously should be in your collection but are not because they cannot make it up the incline belt.

Sample Collection Off a Conveyor Belt

There are three simple methods for collecting unsorted catch off conveyor belts. Just remember to collect before any sorting activities. Any of these methods can be used within your sampling design. They are:

1. **Collecting from the flow of fish:** Hold a container under the flow of fish from the live tank or under the flow of fish falling from one conveyor belt to another. If a fish is legitimately part of your sample but too big to fit in the container, you still include it in your sample!

2. **Diverting the flow of fish:** Use a diverter board to spill fish into a container. A diverter board is a board hinged to the side of a conveyor belt that, when open, allows catch to spill off the belt.



Conveyor belts and motors can be hazardous! Loose clothing, pieces of equipment, and fingers can become caught or tangled with very unpleasant consequences!

3. **Collecting fish directly off the belt:** Collect all catch in a prescribed area of the belt. If there is no place in the factory that allows collection by diverting the flow of unsorted catch you can stop the belt and collect all the catch in an area. To do this:

- Close the bin door and clear the belt by running the fish into the factory. You cannot use these fish, since you cannot be sure that they haven't been sorted.
- Once the belt is cleared, re-start the flow of fish until the belt contains enough for your sample.
- Stop the flow of fish and collect all fish from the belt. If

you cannot take all the fish off the belt, use a prescribed area (from point A to point B) and collect all fish in the area, regardless of species or size. Never hand select fish to include in a sample.

RANDOM SAMPLING ON CATCHER/PROCESSORS

Random sampling is most often achieved on CPs using a systematic sampling design to collect sampling units of weight. As haul sizes decrease, simple random designs become more common.

You and the crew will have a good estimate of total catch weight before the haul is processed and because the catch is passing over a flow scale, you will be able to start your sample at specific, randomly chosen weight values. By using the flow scale to determine the weight value to stop sampling, you can easily supply a total weight for each of your samples.



Record the haul weight used to establish your sample design on your Deck Form. See examples on page 5-47 and page 5-52.

Simple Random Sampling from Spatial Frames on Catcher Processors

A simple random sample (SRS), is sometimes collected for smaller hauls when you can't collect multiple systematic samples. To accomplish simple random sampling from a spatial frame, determine the size of your sampling unit. Sampling units must be equal, so define your sampling units to accommodate the level of species diversity you are seeing in the haul (see "At-Sea Sample Sizes" on page 5-18). Divide the total estimated haul weight by your desired sampling unit size and number these units sequentially. Use the random number table(A-21), a watch, cards, dice, or other approved method to pick a unit to sample.

Systematic Sampling on Catcher Processors

Systematic design is the most common method used on CPs. Systematic sampling involves taking a sample every "nth" sampling unit. For a systematic random design, randomize your sampling start unit within the first sample section and continue to take samples at equal intervals throughout the rest of the sample population. *To simplify the development of your sample frame for an open ended population, always round the vessel estimate*

down rather than up when adjusting haul size estimates. This will decrease the chances of overestimating the haul size and not achieving your last sample.

In order to set up a systematic design, you have to determine two things beforehand - the size of your sampling unit and how many of these you can sample. Once you decide on these two things, you can determine the total number of sampling units in the population and the sequence of sampled versus unsampled units.

Systematic Sampling from Spatial Frames on Catcher Processors With a Flow Scale

Systematic sampling from a spatial frame will be used on vessels with a functioning flow scale. Using the flow scale readout you can determine an exact start and stop weight value for a sample. To create the sample frame, do the following:

1. Determine the size of samples you intend to take. The size of each sample will be dependent on the factors outlined in the section “Sample Size Considerations” on page 5-4. When the catch has low diversity, observers routinely collect multiple samples that when added together equal 1/2 or 1/3 of the entire haul. These samples can be measured in tons. When the catch is more diverse the samples will be much smaller. These samples would likely be measured in hundreds of kilograms rather than tons.
2. Divide the estimated haul size by the intended size of your sample unit. Number the resulting sampling units sequentially.
3. Divide the number of sampling units in your frame

by the number of samples you intend to take. This value represents your sample interval “i”.

4. Choose a random number “n” within the value of your sampling interval. This resulting number corresponds to the first sampling unit you will sample. Samples are taken at this randomly selected unit and every “i” units thereafter (see Figure 5-5 on page 5-16).

Sample sizes will depend on haul diversity. *If the catch is very diverse, reduce sample size as much as you need in order to appropriately account for all organisms in that sample unit (see Figure 5-4 for an example).*

Catcher Processor Sampling Without a Flow Scale

When the flow scale is not available, you must use time to approximate when your weight based sampling unit is available. Using this method to determine when you will collect your sampling units from your sample frame is referred to as using “time as a proxy”, because you are approximating time. Factory managers will usually have an idea of how many tons of fish per hour the factory can run. Use this weight-per-hour estimate as a guideline for how much time it will take the crew to process the entire haul. Ask the factory manager about estimated run time. Always contact your inseason advisor when the flow scale is not in use.

A catcher processor without a functioning flow scale will limit the size of your samples since the entire sample will be weighed with your observer scale (i.e., 100-200 kilograms as opposed to several thousand). To sample effectively you will need to 1) determine the size of sample you can take, and 2) estimate how long it will take

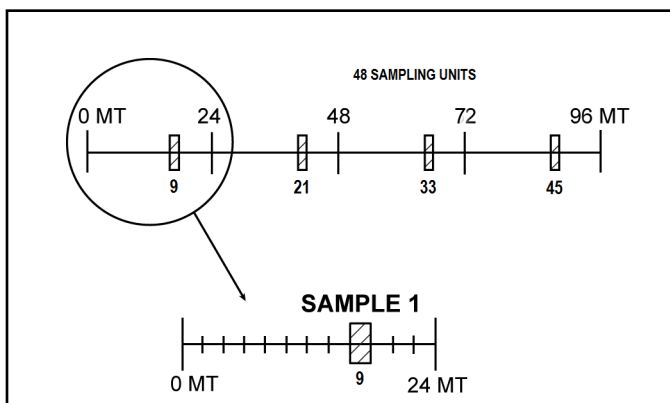

An estimated total haul weight of 96 metric tons was divided by units of 2 metric tons, the amount the observer felt they could sample at a time. This yielded 48 sampling units. These 48 units were further divided by 4 (the number of samples the observer felt they could take) to obtain a sampling interval of 12 units. A random number between 1-12 was chosen to select the starting sampling unit. Unit 9 was selected as the starting sampling unit. Samples were taken at random sampling unit 9 and every 12th sampling unit thereafter, until the end of haul processing

Figure 5-4: Small Systematic Samples on a Vessel with a Flow Scale and High Species Diversity

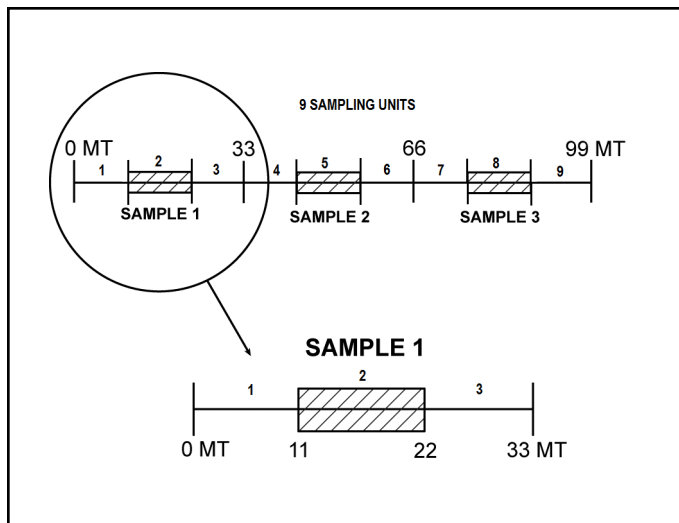

An estimated haul size of 99 metric tons was divided by units of 11 tons, the amount the observer felt they could collect at a time. The resulting sampling units numbered sequentially (1 - 9). These 9 units were further divided by 3, the minimum number of desired samples. A random number was chosen within the resulting sampling interval of 3 units. Samples were taken at this random sampling unit “*n*” and every third sampling unit thereafter, until the end of haul processing.

Figure 5-5: Large Systematic Samples on a Vessel with a Flow Scale and Low Species Diversity

to process this sized sample (this will help you determine how many units you can realistically collect).

The unit code would still be weight as you are still collecting a spatial sample unit, but simply using time as an accurate estimate of when to collect the sample.

If you are on a CP and the flow scale fails during a haul, continue sampling your originally intended unit(s). Estimate the time when the preselected units will have reached your sample area and collect them using standard collection methods. Document when the flow scale fails. If the vessel continues to fish, use time to approximate when to collect your spatial samples (see “Using Time to Approximate Sample Unit Collection” below).

In the GOA, CPs targeting flatfish are not required to use their flow scales. You must use time to approximate when to collect your samples if the vessels opts out from using their flow scale.

Using Time to Approximate When to Collect a Sample Unit

To use time to estimate when to collect your sample unit, follow these steps:

1. Using the methods described on page 5-15, establish a systematic sample design for small spatial sample units. Once you have selected your sample units continue with steps 2, 3, and 4 described here.
2. Divide the total estimated run time of the haul in minutes by the number of sampling units established in step #1. This will identify the estimated duration of a sample unit.

3. Multiply your sample unit “*n*” from the spatial design established in step one by the duration per sample estimate in step #2. This random number represents the approximate time at which you will take the first sample.
4. Subsequent samples are taken throughout the processing of the haul. Use the interval “*i*” established in step #1 multiplied by the time per sample unit from step #2. For example, if “*n*” is the 40th sampling unit and the time per sample is 0.5 minutes, your sampling interval would be 20 minutes (40 x 0.5). See Example 5-2 below for an example of using time to approximate a sample on a CP. Figure 5-3 is an example of sampling from a conveyor without a flow scale.

Your CP is targeting flatfish in the GOA (no flow scale is being used). The captain estimated the haul at 8 tons. You decide to collect a single 200 kg sample. $8000 \text{ kg} / 200 \text{ kg} = 40$ units of 200 kg each. Randomly select a unit 0-39 to sample. You select sample unit 35. They process about 7-8 tons per hour. The factory manager estimates run time at 50 minutes. To establish when to begin sampling: $50 \text{ minutes process time} / 40 \text{ units} = 1.25 \text{ minutes per unit}$. $\text{Sample unit } 35 \times 1.25 \text{ minutes} = 43.75 \text{ minutes}$ ($60 \times 0.75 = 45 \text{ seconds}$). You will start to collect a 200 kg unit as close to 43 minutes and 45 seconds as you can. The sample unit code is still weight as you are only using time as an estimate based on your spatial sample.

Example 5-2 Simple Random Sampling Using Time to Approximate Sample Collection

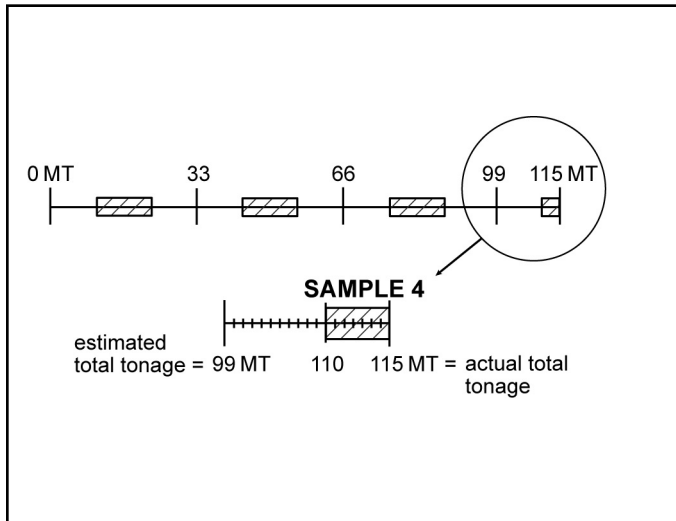

You must maintain your sampling design for the entire catch. If the actual haul size is larger than your estimate, extend your sample frame to accommodate the systematic sampling design for the haul. In this example, the observer was sampling 11 tons with 22 tons between each sample. The actual haul weight was 16 metric tons over their estimated weight for the haul of 99 metric tons. In order to maintain their sampling design, the observer began a sample at 110 metric tons (one interval of 33 metric tons after the start of their third sample). The observer would sample a full 11 ton unit or to the end of the haul, whichever came first.

Figure 5-6: Maintain Your Sampling Design for the Entire Catch

Addressing Challenging Sampling Situations on Catcher Processors

On rare occasions you may not be able to sample the entire originally chosen sample unit or be able to follow your intended sample design. If the original sample unit or design cannot be followed continue to sample the haul. Document the reasons in your daily notes. See “Documenting Sample Design Constraints or Problems” on page 2-26 for common design challenge scenarios. *Record the sample design code and sample unit type on the Observer Haul Form that best describes the method you used to sample.*

You may not be able to collect the entire originally chosen sampling unit. If this happens you will have to stop your sample collection sometime within one of your randomly chosen units. This situation should be avoided with a well planned sample design. However, if you are forced to stop collecting a sample before the entire sample has been collected, follow these guidelines:

1. Before you abandon your original design and sample unit, consider whether collecting a subsample for 2 predominant species would allow you to sample your original intended unit size. If you decide to collect a random subsample from the remainder of the unit, record the 2nd predominant in your subsample only. The weight for this species will be accounted for in the subsample. See “Subsampling for Two Predominant Species” on page 5-20 for subsample guidelines.
2. If a subsample is not possible, follow these guidelines for your smaller samples:

- If you are collecting 3 systematic samples and the first sample must be reduced in size from the original design, make all subsequent samples the same size as that first smaller than intended sample. Determine a sample size that is feasible for the remaining units left to be sampled. A good guideline for this is to try to make the new sample size consistent with the first sample that you had to reduce in size. For these smaller subsequent samples, use the start time/weight laid out in your original sample design.
- If you are collecting 3 systematic samples and the 1st sample unit is sampled without incident, but the second sample must be abandoned at some point due to high diversity, the 3rd sample should follow the original intended unit size. If that is not possible, attempt to keep sample 3 of consistent size with sample 2.

In order to achieve similar sample sizes over the course of one sampled haul, tailor the sample size to accommodate the most diverse portion of the catch. Establish a unit size that you know you can sample consistently through the entire haul. If you are constantly sampling less than your intended unit, you must come up with a new unit size, frame and possibly an entirely new sample design. Contact your inseason advisor or visit the field station if questions remain.

AT-SEA SAMPLE SIZES

It is generally the case that the size of your samples can be larger with clean catch (species diversity is low) than with dirty catch (species diversity is high). Even with clean catch, the factors discussed under “Sample Size Considerations” on page 5-4 play a significant role in sample size maximums.

Catch With High Species Diversity: Small Sample Sizes

On bottom trawl catcher vessels and catcher processors when hauls are “dirty” (there are many different species in the catch), it is unlikely you will be able to obtain sample sizes of several tons as you can on catcher processors with flow scales and a clean catch. With high diversity catches, you usually have to resort to taking sample sizes that can be feasibly weighed using the observer scales or the vessel’s MCP scale. *Typically, observers working with high diversity catches are able to routinely sample 300 - 500 kg for the haul.* Sample sizes totaling from 300 - 500 kg for hauls taken by bottom trawl catcher vessels (for example, fishing flatfish and Pacific Cod) are common because:

- The catch tends to be smaller.
- The catch is usually dumped on deck for sorting.
- Processing times are quicker.
- Hauls are more frequent.
- The catch composition is usually quite diverse.
- Space is limited.
- In instances where there are two predominant species.
- The catch of prohibited species is usually higher.

On vessels with flow scales (all catcher processors targeting pollock and a large contingent of bottom trawl catcher processors targeting flatfish and Pacific Cod) high species diversity in a catch significantly influences the maximum size of species composition samples.

Catch With Low Species Diversity: Haul Census

This option is only viable if there are one or two predominant species in the catch. Sampling an entire haul for species composition requires that you account for all organisms in the haul.



This is a haul census. In order to conduct a haul census the following criteria must be met:

- You must be able to see every organism in the catch as it passes you. If you are missing organisms while attempting a sample of all the catch, alter your approach and collect smaller, more accurate samples instead.
- You cannot leave the sorting area, and you cannot do anything other than sort or supervise the sorting of the catch.
- You must sort out all by catch from the entire catch. If crew members are assisting you in sorting, you must have direct, visual supervision of them! Make sure that the crew realizes you are sampling and know you want all bycatch species set aside.
- You must be able to weigh and count all the bycatch from the haul.
- You must take a subset sample of the predominant species from within the sample unit.
- In instances where there are two predominant species, a subsample for these two species must be taken from within the sample unit.

To fulfill these requirements, your vessel must be participating in a fishery with very low diversity. In the pollock fishery, hauls may have less than 1% bycatch, and sampling the entire haul for species composition might be possible. Keep in mind that you must have time, energy, space, and a low-diversity haul!



Even 1% bycatch in a 50 mt haul is 500 kg- about thirteen 40 kg baskets!

Sampling an entire haul may not be possible if you do not have sufficient access to the catch, space to store bycatch, or time to monitor the entire haul. When this is the case, reduce sampling effort and take several samples (a minimum of three) from the haul instead of

the entire haul. Adjust your sample size to the diversity seen, as appropriate.

Catch With Low Species Diversity: Large Sample Sizes

This option is only viable if there are two or less predominant species in the catch. While sampling an entire haul is ideal, it is more often the case that observers obtain large samples from within the haul. This is primarily because processing times for large bags can be lengthy and observers have other sampling duties. The strategies and catch composition criteria for sampling over large sampling unit sizes are the same as those for sampling the entire catch; species diversity must be relatively low, and you must be able to collect and weigh all the bycatch from within your sample.



When sampling, you must obtain a defined sample weight. Visual estimates such as “about half the catch” are not acceptable.

Catcher Processors Fishing AFA and CDQ Pollock

These vessels are required to have flow scales and the fishery tends to be clean, so sample sizes of several tons are common for composition data. Remember that, even in the pollock fishery, bycatch may be too diverse for you to achieve very large sample sizes. If the catch is diverse, drop your sample size to the size necessary to account for all species in the sample (see “Catch With High Species Diversity: Small Sample Sizes” on page 5-18 and “Catch With Low Species Diversity: Large Sample Sizes” on page 5-19). Remember, you must be able to account for all species for which you are sampling!

Vessels Fishing Limited Access Non-AFA Groundfish

The catch in non-AFA limited access hauls tends to be high in diversity. The level of diversity impacts sample size; the higher the diversity, the smaller the sample size has to be. Drop your sample size to the size necessary to account for all species in the sample (see “Catch With High Species Diversity: Small Sample Sizes” on page 5-18). Remember, you must be able to account for all species for which you are sampling!

Determining Weight of Large Samples by Flow Scale Readout

You must use the certified flow scale to determine your sample weights if you are sampling large sample units during limited access privilege fisheries. Sampling in limited access privilege fisheries is discussed in more detail starting on page 5-40. Keep in mind that you may use the flow scale to obtain sample weights during any fishery provided the crew is testing the scale correctly, the scale passes these tests (see “Motion Compensated Electronic Scales” on page 2-29), and there are no more than two predominant species in the catch. The maximum size of the sum of your samples for a haul will ultimately depend on the factors discussed on page 5-4.

Getting a sample weight by flow scale readout is easy and accurate. Record the weight from the readout prior to sampling *on your Deck Form*. Remove all non-predominant species from the sorting belt after the flow scale. Record the weight from the scale readout after you have completed your sample for species composition *on your Deck Form*. The difference between the end weight and the start weight is the sample weight. How you get the weight of the predominant species will depend on whether there are one or two predominant species in the catch. Refer to the following discussion concerning clean catches with one or two predominant species.



If the flow scale is not working, you must obtain sample sizes via the on board MCP scale or your observer scales.

If the Flow Scale is Not Working

If the flow scale is not working continue to sample hauls. Sample weights can only come from the motion compensated platform (MCP) scale or your observer scales. The options for sample sizes in this case would be limited: 1) samples would have to be small enough to weigh on the MCP or observer scales, or 2) the haul would have to be clean enough that you could sample the entire haul (weigh all bycatch on your scales).

Clean Catches With One or Two Predominant Species

On catcher processors with flow scales and a clean catch (a maximum of two predominant species and low amounts of other species), the flow scale can be used to determine sample size and all non-predominant bycatch can be weighed by the observer on the MCP scale. To determine the one or two predominant species, use a

visual estimate of count or weight. Under these sampling conditions it is expected that you obtain large sample sizes, often several tons in weight. Typically, observers working with clean catches and a flow scale are able to routinely sample 1/3 to 1/2 of the catch. If the haul is small in addition to being clean, you may be able to sample the entire catch. For slightly dirtier catches you can still sample for one or two predominant species but the sample size may need to be smaller and your total sampling fraction will be less than it would be for a cleaner haul. The goal of your random sample collection is to take at least three systematic, consistently sized, large samples.

One Predominant Species

For samples with one predominant species, you allow the predominant species to pass by while you remove all non-predominant bycatch. All bycatch from the sample is weighed and counted. When there is only one predominant species in a sample, you must take a random subset sample of this predominant species. Subset samples are discussed on page 2-27 and on page 5-24. The weight of the one predominant species is simply the flow scale sample weight minus the weight of bycatch and the weight of the subset sample.

Two Predominant Species

When there are two predominant species in the catch, all bycatch from within the sample is weighed and counted as above, but you must take a random subsample specifically for those two species.

Subsampling for Two Predominant Species

When there are two predominant species in a catch, there is no way to determine the proportions of each in a sample without actually weighing them. Having to weigh two predominant species in a sample would significantly limit the sizes of samples an observer could obtain. To supply species specific weight information to resource managers and still maintain large samples, you can take a random subsample for the two predominant species in the catch. These subsample data effectively give the relative proportion of the two predominant species in the sample. Management extrapolates subsample data to get the relative weight of the two predominant species in the parent sample and ultimately the entire catch.

On trawlers, when there are two predominant species and minimal other bycatch, take one or more subsamples

for those two predominant species. If the catch is so diverse that you have more than two predominant species or cannot account for all other bycatch from within your sample, you should not be subsampling. Consider drastically reducing your sample size so that you can account for all species within the sample! (See “Addressing Challenging Sampling Situations on Catcher Processors” on page 5-17).

The two predominant species in the parent sample must be identified to the level prescribed in the Species Identification Manual and Rockfish Guide (see “Species Identification” on page 2-13). The only exceptions to this rule are the Observer Program species group Northern/Southern Rock Sole, Arrowtooth/Kamchatka Flounder, and Shortraker/Rougheye Rockfish.

When one or both of the two predominant species in the sample are the species groups Northern/Southern Rock Sole, Arrowtooth/Kamchatka Flounder, or Shortraker/Rougheye Rockfish a random subsample for two predominant species may be used. The species group in the parent sample must be identified and recorded to species level in the subsample. This subsample will also serve as the species group subset sample for species identification. There are some specific sampling protocols associated with subsamples:

- Subsamples must come from within a sample.
- The minimum size of an individual subsample for two predominant species is **80.0 kg**.
- *You must continue to take subsamples until both the predominant species occur in the same subsample.* Typically, if you have assessed the catch correctly, only one subsample will be necessary to account for the two predominant species. If you are finding that it takes multiple subsample attempts to capture both the predominant species in one subsample, you should reassess predominance!
- The initial subsample must be randomly chosen. If you need to take another subsample because both predominant species were not present, take it immediately or as close to the initial subsample as possible.
- In cases where multiple subsamples are attempted for two predominant species, each attempt must be documented in your species composition as a discrete subsample.

- Everything that lands in your subsample is documented in the species composition data for that subsample. If you subsample for pollock and squid, and get pollock, squid *and Flathead Sole* in your sample, you report pollock, squid *and Flathead Sole* in the species composition data for that subsample
- You must follow the numbering scheme for subsamples discussed on page 5-44.
- *You cannot subsample for prohibited crab and salmon species in trawl samples. See “Counting and Weighing Prohibited Species Crab and Salmon on Trawlers” on page 5-24 for more information.*

If you find that you have taken multiple subsamples for two predominant species and none of these has contained both predominant species for which you subsampled, you cannot enter any of the data for that subsample or its parent sample.



A new random number must be selected for every subset and subsample collected within a haul.

If You Can't Meet the Minimum Sample Size Requirements

The smallest sample sizes suggested for the various sampling situations are the Observer Program's minimum standards. These minimums should be exceeded whenever possible. If you find that you cannot obtain species composition sample sizes that meet or exceed the Observer Program's minimum expectations, contact your inseason advisor or other Observer Program staff as soon as possible. Remember to document in the Daily Notes section of your logbook each occurrence when the sum of sample weights for a haul falls below the minimum expected sample size.

FLOW SCALE - MCP SCALE WEIGHT COMPARISON FORM

Observers on CP trawlers and Motherships equipped with a flow scale must complete this data collection.

Information for this comparison data is collected directly from subsets, subsamples, or small species composition samples of diverse catch which are weighed on the flow scale and then on the observer Motion Compensated Platform (MCP) scale. The Flow Scale - MCP Scale Weight Comparison data must be clearly labeled on the

deck sheet (see Figure 5-9 on 5-49). Record *the entire Flow Scale weight start and end as it is displayed on the flow scale readout. Do not report only the last 3 or 4 digits!* The instructions for this data collection are listed below.

1. Flow scale - MCP comparison data is recorded from each sample that is randomly selected for the collection of predominant species sex/lengths. At the appropriate flow scale weight, have the crew stop the flow of fish and clear the belts and areas “upstream” from your sampling area. Place the diverter board across the conveyor to divert fish into your baskets. On your Deck Form record the start weight as displayed on the flowscale.
2. Release the sample from the live tank with the help of the crew as normal. Collect *all* fish from belts into your baskets (or totes if needed) and record the full field end flow scale weight on your Deck Form.
3. Work up your sample as outlined in your manual weighing *all* the fish with your MCP.

The Flow Scale - MCP Scale Weight Comparison Form is found in the Species Composition button in ATLAS. Complete the following fields:

- Sample Number.
- Sample Date: Enter the date the comparison was performed.
- Start Flow Scale Weight.
- End Flow Scale Weight.
- MCP Scale Weight: This is the weight of fish weighed entirely by your platform scale (i.e. subsets, subsamples, or small composition samples).
- Comments: This box is used for any unusual circumstances or difficulties in the collection of your samples.

Contact your inseason advisor if you are unable to complete this task due to the boat's sorting line set up, or if you encounter any problems with this form. For instructions in ATLAS, see 18-11.



When collecting the Flow Scale - MCP Comparison data, be sure to weigh ALL catch that went over the flow scale on the MCP.

PROCESSING YOUR AT-SEA SAMPLES

Once a sample has been collected, sampled species need to be identified, counted, and weighed. Certain aspects of sample processing will depend on space available for sorting, catch diversity, and the size of your sample. For every sampled haul, you are also expected to collect biological information on one or more species. Methods and details pertaining to collection of biological data can be found in the “FISH MEASUREMENT AND SPECIMEN COLLECTION” and “PROHIBITED SPECIES SAMPLING” chapters. Keep in mind that you may also need to collect additional specimen samples or information for a research project assignment.

Identification of Sampled Species

Resource managers rely on species specific data to monitor catch rates and quotas. It is important that observers report sampled fish to species level or, where appropriate, group level. The characteristics you used to identify a species must be documented on a Species Identification Form. You are required to fill out a form for every fish seen on your first contract and every new or rare fish seen on subsequent contracts. Observer Program staff use these forms to assess your species identifications as well as your identification skills. You must take the time to complete these forms with the specimen in hand! For details on how and when to complete these, see “Species Identification Forms” on page 2-13.

Accounting for Pre-Sorted Samples

A pre-sort is an organism that is removed from the sample population and no longer available for the observer to sample. Pre-sorted organisms must be recorded as a discrete sample in the species composition data for the haul.

The organisms most often pre-sorted are large sharks, skates, and halibut. Refer to “Sample Bias” on page 5-5 for more information on pre-sorting mechanisms. Follow the guidelines below when assessing the catch for pre-sorted organisms.

- To be considered pre-sorted, organisms must **not** have had a chance to be in a composition sample. Typically, this means that the organism was removed from the catch **prior** to composition sampling. Examples of pre-sorted organisms include: 1) Crew members actively going into the tank to remove an organism that may

have been included in the sample if it were not removed.
2) Organisms that are isolated on deck and could not enter the live tanks because of excluder bars.

- If an organism is removed **between** composition samples from the flow of fish into the factory (*e.g.*, from incline belts and/or conveyor belts outside of the tank) or from a part of the deck that is not going to be sampled, it is **not** truly pre-sorted. That animal had the chance to land in your sample, it just didn't land in your sample because of where or when you happened to take it. Examples of organisms not being truly pre-sorted include: 1) Between composition samples a shark is removed from the conveyor belt because it is too large to go over the flow scale. 2) A large halibut is stuck in the live tank door that delivers fish to the factory. A crew member removes that halibut during a period you are not sampling. 3) A crew member on a catcher vessel removes a Salmon Shark from the trawl alley when you are done collecting your samples.
- If an organism is removed from the flow of fish into the factory (*e.g.*, incline belts and/or conveyor belts outside of the tank) **while you are sampling** it is not considered as having been pre-sorted. The organism is considered part of your sample because it would have landed in your sample if it was not removed. This organism must be included in your species composition and its weight added to the final flow scale weight if it did not go over the flow scale. Example: A large shark cannot go over the incline belt during your sample period. A crew member removes the shark from the incline belt and gives you the shark to weigh.
- You must have access to all pre-sorted organisms so the numbers and weights can be determined for your species composition.
- Crab pots, marine mammals, and large items are not recorded as pre-sorted; see “Crab Pots” on 5-26 and “Marine Mammals and Large Items” on page 5-26 for more information.
- Organisms caught outside of the codend should be reported as a pre-sorted sample provided they are made available to you and are safe to access. During retrieval, the vessel is not expected to remove these organisms from the trawl net but many will do so to prevent damage to the gear.

Halibut Deck Sort Pre-Sorted Samples

If your vessel is participating in halibut deck sorting, all halibut that are removed during the deck sort process must be recorded as a pre-sort sample. See page 5-38 for specific instructions on how to record halibut deck sort pre-sorted samples.

Any other pre-sorted organisms that are removed from the sample population within the same haul in which halibut deck sorting occurred, must be recorded as a separate discrete pre-sorted sample. This includes halibut that may be pre-sorted inside of the factory. Follow the guidelines described below on how to record these data.

Recording Data for Pre-Sorted Organisms

- Count and/or weigh everything you see pre-sorted out of the catch. Document these data on the species composition form as a discrete sample with its own unique sample number. Sample number 9000 is specifically reserved for halibut that are removed during the halibut deck sort process. All other pre-sort samples must be recorded using a different sample number. All pre-sorted samples must be designated as such by checking the “Pre-sorted” circle for that sample.
- For very large halibut, use the “Halibut Worksheet” in ATLAS to derive the weight from the actual length of the halibut. For very large Pacific Sleeper Shark, Salmon Shark, Longnose Skate, or Big Skate you may use the appropriate length to weight table to derive a weight if you recorded an actual length. The “Shark Length to Weight Tables” starts on page A-47, and the “Skate Length to Weight Table” is on page A-49. Do not use the length to weight tables for estimated lengths. If you cannot obtain an actual length, enter a value in the field for number of individuals but enter “0” in the weight field. For discard data, use an estimated length to determine weight. Document the situation on your Deck Form, along with any estimated lengths.
- Only use length/weight tables approved by NMFS.
- For organisms other than Pacific Halibut, Pacific Sleeper Shark, Salmon Shark, Longnose Skate, or Big Skate that are too large to weigh, record the number of individuals and enter “0” in the weight field. For discard data, use an estimated weight for the pre-sorted individual.
- *The sample size for this pre-sorted sample is the Observer Estimate for the haul, or the Vessel Estimate if*

an Observer Estimate was not made. Ensure the weight of the pre-sorted item(s) is included in the Observer and Vessel Estimates. Add the weight of the pre-sorted item(s) to the Observer and Vessel Estimates as appropriate.

Counting and Weighing Sample Items

In most fisheries, observers find it easiest to sort their sample, and then count, weigh, and record each species separately. In low diversity fisheries (for example, pollock) you may choose to weigh the unsorted sample and then sort the sample. If you weigh unsorted fish and then sort out bycatch, the predominant species weight is the total sample weight minus any bycatch weight.



Generally you will be using some container (e.g. a basket) to weigh your fish. **Remember to tare the scale for this container!** Check your tare frequently and tare every time you change containers! If your scale is not properly tared the weights will not be accurate. For more information see “Taring Your Scales” on page 2-28. **Every organism in a trawl sample must have a weight associated with it (with one exception; see “Large Organisms” below).** Only actual weights taken using a NMFS approved scale or NMFS approved length/weight tables may be used, unless otherwise directed by NMFS staff. **It is not acceptable for you to make your own weight estimate for any species in your species composition sample; doing so may invalidate the data.**

Large Organisms

The one exception to the need for a weight entry is for large items that cannot be weighed and for which a NMFS length/weight table does not exist. For these large items, enter zero in the weight field and notify NMFS.

For large Pacific Halibut, Pacific Sleeper Shark, Salmon Shark, Longnose Skate, or Big Skate that are too large to be weighed on your scales, you may use the appropriate length/weight table to provide a weight in the species composition data if you took a length measurement. If the length you recorded is not on the length/weight table, contact NMFS. Do not use the length/weight tables for estimated lengths. If you cannot take the measurement,

document your estimated length on the Deck Form and contact NMFS.



Trawler species composition data must have weights for all sampled species. Large items that cannot be weighed and do not have a length/weight table are the one exception; for these items, enter zero in the weight field and notify NMFS.

Small Organisms

Small organisms may not register on the scale but must be accounted for in your composition sample. Enter these with a weight of 0.01 kg.

If you cannot supply an actual weight for every organism (except for very large or very small items that cannot be weighed) your data cannot be used.

Prohibited Species in Species Composition Samples

Salmon, king and Tanner crab, herring, and halibut are prohibited species that you may encounter in your species composition sample. Along with recording number and weight information, king and Tanner crab and all salmon species are required to be identified to species and grouped by sex. Additional biological data are also collected from prohibited species. These include the presence of eggs for female crab, scales and genetics for salmon, and viabilities for halibut. See “PROHIBITED SPECIES SAMPLING” on page 12-1 for specific instructions.

Counting and Weighing Prohibited Species Crab and Salmon on Trawlers

Unlike other species encountered in the North Pacific, resource managers regulate the harvest of prohibited species crab and salmon by number and not weight. For this reason you must always provide a number along with weight for every prohibited species crab and salmon encountered in your trawl samples. ***Subset samples are not appropriate for prohibited crab and salmon species on trawlers!***

When developing your sample design and preparing to sample an individual haul be sure to consider the additional data requirements for prohibited species. Define the sample unit size accordingly to ensure you can complete all your required duties. If you anticipate being overwhelmed with crab or salmon during your sample, you must reduce the size of the sample to ensure you are

able to provide an accurate count of these species. ***You cannot subsample for prohibited crab and salmon species encountered in your trawl samples.***

Recording Crab Parts on Trawlers

There is an exception to the rule that a number must be provided for all prohibited species. On trawlers it is common for prohibited crab species to break apart, making the determination of a true number nearly impossible. The Observer Program asks that you record data on prohibited crab species in the following way:

- Identify all whole crabs to species and report their number and weight. For our purposes, a crab is considered whole if it is essentially whole by weight. It is not necessary for a crab to be completely intact to be considered whole.
- Identify loose crab parts to the best of your ability. Carapaces should be identified to species and legs can usually be identified to the appropriate genus group code. Report the weight of these parts on a separate line from any whole crab weight/number values and enter a value of zero for number of crab.

Subset Sampling for Number and Weight on Trawlers

Sometimes organisms are too numerous (hundreds of individuals), or too broken, to count accurately. If this is the case, the Observer Program allows you to report a portion of those individuals by weight only, without the number of individuals. For each occurrence you must weigh and count ***at least 50 randomly selected individuals per sample. This collection is referred to as a subset sample and these data are reported in your species composition data for the sample. For each species in each sample that you take, the number and weight should be recorded at least once (see Figure 5-8 on page 5-48).***

A subset sample for number and weight provides data users with values necessary to calculate an average weight for the species. On the species composition data form, individuals with weight only are entered on a separate line from those with weight and number. For the entry that has no number of individuals, a zero is entered in the number field.

Subset samples will be common for those assigned to catcher processor pollock vessels. In this fishery observers often find themselves sampling for one predominant species. Remember that when sampling

for one predominant species and using a flow scale, you provide the weight of the predominant species (which often amounts to several tons) by subtracting the weight of bycatch from the flow scale sample weight. A zero is entered in the number field. A subset sample is needed in these instances to provide data users with values necessary to calculate the predominant species average weight.

Other times when you might take a subset sample for number and weight are:

- When there are numerous brittle stars or jellies in a sample (these may be bits and pieces, or whole animals).
- When there are hundreds of small individuals of one species (usually flat fish).

If you are sampling for two predominant species, the required subsample will provide the number and weight relationship needed by data users. *Do not confuse the terms subset sample and subsample!* For more information on subset sampling for number and weight, please refer to “Subset Sample for Number and Weight” on page 2-27.

Collecting a random subset sample for number and weight is a valuable sampling tool that will allow you to take larger samples, *but this method is not appropriate for prohibited crab species and salmon on trawlers!*

Refer to “Counting and Weighing Prohibited Species Crab and Salmon on Trawlers” on page 5-24 for more information about sampling these species.

Subset Sampling for Species Identification on Trawlers

Several species have similar morphological characteristics, making it difficult to distinguish one from the other at first glance. A few of these species also tend to be prolific in certain fisheries. Identifying each fish to species would be a time consuming task if a sample was inundated with representatives from these similar species.

The Observer Program allows for subset sampling of 20-30 randomly selected individuals for these similar species when they occur in quantity. This compromise yields species specific information important for resource management while allowing observers enough time to process samples and complete other sampling related duties.



A new random number must be selected for every subset sample collected within a haul.

The species sets that you can subset sample for on trawlers are: Northern/Southern Rock Sole, Arrowtooth/Kamchatka Flounder, and Shortraker/Rougheye Rockfish.



For more information on species subset sampling, please refer to “Subset Sampling for Species Identification” on page 2-27.

Seabirds

Seabirds occur in samples infrequently. If a seabird lands in your at-sea sample, it is reported in that sample! See “SEABIRD INTERACTIONS” on page 16-1 for more information.

Decomposed Fish, Fish Waste, Damaged Fish, and Miscellaneous Items

Decomposed fish (code 899) are those organisms in an obvious state of decomposition, with a breakdown of muscle and skin. Prohibited species crab and salmon should never be recorded as decomposed fish as you must always provide a number along with weight whenever these species are encountered in your trawl samples. Fish waste (code 899) is considered anything caught that was previously processed by a vessel. An example of this would be a fish head that was clearly cut by a machine. Prohibited species may be recorded as fish waste. Damaged fish must be distinguished from decomposing fish. Damaged fish are those that are smashed, torn apart, or mutilated. Damaged fish should be identified, weighed, and recorded along with other undamaged fish of the same species. If the damaged fish cannot be identified to species then use the most appropriate group code such as flatfish unident (100), rockfish unident (300), roundfish unident (200), or fish unident (901). Miscellaneous items (code 900) include garbage, fishing gear, wood and other debris that may appear in your sample.

All decomposed fish, damaged fish, fish waste, and miscellaneous items in your species composition samples must be weighed. If you are able to count the items, report this number in the species composition data. If you are not able to count these items, enter zero in the

number field for these individuals. *Damaged prohibited species must be counted.*

Conjoined Items

When conjoined items (e.g. sea anemone on a rock) are encountered in your sample, try to separate the two items then count and weigh them separately. If you are unable to separate the two items, weigh them together and record them as miscellaneous (code 900) with a count of zero. Document the situation in your Daily Notes.

Corals

Corals are marine invertebrates that typically live in compact colonies of many individual polyps. When you encounter coral in your species composition, the coral should be identified and separated to order using the corals guide in the Species ID Manual provided. The six major groups of coral in the ID guide include: Hydrocoral, Stony Coral, Gorgonians, Black Coral, Soft Coral, Sea Pens and Sea Whips. If you are unable to identify the coral, list it as coral unidentified and collect a specimen or take photos. Specimens should also be collected when ever you encounter a new group of coral. These specimens will be reviewed during the debriefing process.

For trawl vessels, all organisms of the same order must be grouped together and recorded with a number of 1 (regardless of the number of individual organisms) with its measured weight. If the organism is too small to be weighed, a weight of 0.01 kg must be recorded.

Combined Samples

There are going to be occasions when you are processing a sample and come across a fish that you think might belong to a previous sample taken for the haul. When you know that a fish should be included in the species composition data for the haul, but do not know exactly what sample, you must resort to “combining” samples. You only combine those samples that you are unsure of; any intact samples are reported as discrete samples for the haul. Mark samples as “Combined” if you collect multiple samples from a haul but due to limited storage, you have to store them in the same container (i.e. a single checker bin).

On the Deck Form, mark the samples that will be rolled together as combined by checking the circle next to “Combined” for those samples. The combined samples are reported as one sample in ATLAS. When reporting

combined samples, enter the data for all the samples affected under a single sample number. By combining samples into one in the reported data, you are alerting data users to regard these samples separately from intact samples. Remember, you can have a mixture of combined and non-combined samples for a haul. You combine only those samples you believe may not be intact, complete samples. For an example of a combined sample recorded on a Deck Form see Figure 5-19 on page 5-59.

Marine Mammals and Large Items

Occasionally marine mammals or large items (such as a boulder or 55-gallon drum) are caught by trawlers. To prevent the weight of mammals or other large objects from being misinterpreted by fishery managers as fish weight, do not include the weight of the item in the Observer Estimate. Also, do not include such items in your species composition samples.

Crab Pots

Trawlers occasionally pick up a crab pot in the net. Record these instances on your Vessel Haul Form in the Gear Performance field (see page 4-17). Crab pots are not included in the Observer Estimate or the species composition sample. Do not include any crab or fish that are in the crab pot in your sample; the items in the crab pot were caught by the pot, and the pot was caught by the trawl. Note the incident in your logbook, with a description of the pot, any identifying numbers or tags, whether it was retained or not, and an account of the contents.

Crab in the BSAI Pollock Fishery

All vessels participating in the BSAI pollock fishery are required to use pelagic gear. The presence of 20 or more of any species of crab indicates the vessel was non-pelagic fishing, or “fishing the bottom”. When more than 20 crab occur in a pollock haul, observers are asked to do the following: 1) count and measure any crab in the composition samples, regardless of species and 2) measure all the crab you find. If there are too many, measure as many as you can. Record only those crab found within your species composition sample on your Species Composition Form and Length and Measurement Form. If your vessel has ATLAS, enter data from only those crab found within your species composition sample. Clearly label the crab found within your species composition sample and the crab found outside of your species composition sample on your

Deck Form. See “Measuring Crab in the BSAI Pollock Fishery” on page 12-4 for more information.

Fish that were discarded at sea prior to delivery should be considered as not retained. Estimate the amount of each species discarded and adjust the reported percent retained value accordingly.

ESTIMATING PERCENT RETAINED

Each species reported in the species composition samples for a haul must have an associated estimation of percent retained. A fish is considered fully retained (100% retained) when more than 15% of its round weight is turned into product. Round weight is the weight of the whole fish, prior to processing. *Percent retained is only an estimation, and your effort and time spent obtaining it should be minimal!*

During the processing of your third sample for the haul (out of 6 total), the vessel decides to dump the rest of the catch because the fish have been sitting on deck too long and are rotten. You estimate that the amount of fish overboard is about 50% of the entire catch. Initially, for your first two samples, Yellowfin Sole and rock sole were being 100% retained. Ultimately, 50% of the entire catch was dumped overboard; the percent retained for Yellowfin Sole and rock sole was 50% for the haul. For every instance that Yellowfin and rock sole showed up in your samples, you would record 50% in the percent retained column. Fish that were 0% retained initially would still be 0% retained.

Percent retained is often difficult to estimate because discard can happen in a variety of places. Make your estimation based on what you see happening, on a haul by haul basis. Potential types of discard include fish falling off belts, dumping of large portions of catch at sea and size sorting of fish. *If the vessel dumps a portion of catch at sea, none of the species groups should be considered fully retained.* For example, if 30 mt of an 80 mt net is dumped overboard, 3/8ths of all the species have been discarded. Therefore, you would record no more than 5/8ths (or 63%) of any group as retained.

Example 5-3 Determining Percent Retained



The percent retained you report for a species must be consistent for the species over all the samples collected during that haul.

Percent Retained and Improved Retention/Improved Utilization (IR/IU)

The percent retained you report for a species in a sample must represent the haul level retention for that species. See Example 5-3 on page 5-27 for an example of determining percent retained.

Through industry initiative, the North Pacific Fishery Management Council created a program to reduce bycatch and improve utilization of harvested groundfish. Since 1998, Improved Retention/Improved Utilization (IR/IU) standards have required all vessels to retain and utilize 100% Pacific Cod and pollock in the BSAI and GOA when the open access fishery for these species is not closed. In January of 2003, IR/IU regulations were expanded to the shallow water flatfish complex for vessels fishing in the GOA.

Percent Retained on Catcher/Processors

In most cases aboard CP vessels, percent retained will be your visual estimation. Sometimes a CP will put up product and later discard it to make room in their freezer for a more valuable product. This is called “high-grading” and it should be noted in your logbook as a possible regulation infraction. Since you will not know which hauls the product came from, do not change your earlier figures for percent retained.

The Groundfish Retention Standard (GRS) program further regulates non-AFA groundfish trawl catcher processors with requirements for the amount of groundfish that must be retained and the amount that must be made into a primary product.

Percent Retained on Catcher Vessels

Everything that is delivered to the processing plant from a catcher vessel is considered retained. The processor may later discard it or even give it back to your vessel for discard, but as long as it was delivered, it is considered retained.

Once the fisheries for IR/IU species are closed, vessels are required to keep the maximum retainable amount for these species. *Note that your sample is not covered under the IR/IU regulations, so fish discarded as a result of you working up your sample (e.g., taking otoliths, sexing fish, or completing a stomach sample) do not need to be factored into percent retained.*

Vessel personnel might challenge you on your percent retained estimations for IR/IU species. You should document your conversations if this happens. Do not make any changes to your percent retained methodology because of the IR/IU regulations, or pressure from the crew. The fishing industry has been informed that percent retained estimates are visual estimates only. If vessel personnel have questions about this regulation, refer them to the Alaska Regional Office or to the NMFS Office of Law Enforcement; see page A-61 for the contact numbers.



Because the percent retained value must represent the haul level retention for a species, you may find it easier to fill out the percent retained column for fish in your samples after you have finished sampling the haul.

SALMON IN THE SHORESIDE POLLOCK FISHERY

Along with the normal species composition requirements of trawl vessels, observers in the pollock fishery have additional sampling requirements for salmon. There are different regulations and observer duties pertaining to salmon in the Bering Sea (BS) and Gulf of Alaska (GOA) and although observer duties are similar, there are important differences in sampling protocols that must be followed. Please be sure to follow the protocols for the region your vessel is fishing in.



Salmon are managed by number, not weight. An accurate count of salmon caught is crucial for stock management!

BS and GOA Salmon Retention

There is a cap on the number of Chinook salmon that can be taken as bycatch in the BS and GOA pollock fishery. In the BS, regulations for the monitoring of salmon for all AFA catcher processors, motherships, catcher vessels and plants receiving BS pollock must be followed. Management of the BS Chinook Salmon catch limits by industry is dependent on NMFS observer salmon retention data. In the GOA salmon retention is regulated. All salmon caught in the trawl fishery must be delivered to the processing facility to be accounted for.

In both the GOA and BS catcher vessel pollock fisheries the vessel is required to deliver all salmon to the shoreside or at-sea processor. This includes all salmon

that are caught in the gear outside of the codend. While monitoring the haulback, watch for salmon outside of the codend. If encountered, inform the captain of your observations and request that all salmon found outside of the codend be placed in the RSW tanks along with all other catch. Document a potential violation, any time the vessel fails to retain one or more salmon of any species for delivery.

Plant/Offload Diagram

For all pollock deliveries, vessel observers should be able to describe the offload process and how the plant is weighing the delivery. For pollock offloads document the flow of fish in your logbook. Include diagrams and details in your daily notes as needed. Include any areas in the flow of fish where sorting may occur.

POLLOCK CATCHER VESSEL OFFLOAD: SALMON MONITORING REQUIREMENTS

Offload Salmon Retention Count Bering Sea and Gulf of Alaska

In addition to at-sea species composition sampling, the pollock delivery must be monitored in its entirety for salmon bycatch as these salmon data are reported to NMFS via the Salmon Retention Form (see page 12-16 for salmon retention information). Salmon must be identified to species and counted by an observer for all pollock deliveries. The monitoring of the offload for salmon is referred to as the offload salmon retention count. While the offload sampling duties are different for observers dependent on region (BS or GOA) a full accounting of salmon is required in both areas.

Encountering a Large Number of Salmon in the Offload

On occasion, a vessel delivery will contain several hundred to several thousand salmon. This is most likely to occur during the fall pollock fisheries. When there are excessive amounts of salmon in a delivery you are still *required to identify all to species and count them all for the salmon retention data. Remember that salmon are managed by number.* As a result it is important that salmon identification and counts are accurate.

Salmon Identification: Contentious Fish ID

If the identification of a salmon is in question:

- Count the gill-rakers on the first arch and record the information on your Deck Form.
- Collect the salmon as a specimen and take it to an Observer Program field office.
- Use your NMFS issued camera to take several photos of identifying characteristics. Include the completed Bag and Tag label in the photo.

Bering Sea Pollock Catcher Vessels

Pollock CVs dump fish into holding tanks onboard and deliver the catch to processing plants. In addition to sampling at sea for species composition, the entire pollock delivery must be monitored for salmon bycatch. Monitoring the delivery is required for observed vessels. A few specifics about pollock CV duties in the Bering Sea:

1. All pollock hauls must be sampled at sea and must have a discard estimate entry on the OHF. A discard estimate is required regardless if the haul was sampled or not.
2. In the rare event that a haul is not sampled for species composition the reasons for the haul not being sampled **must** be documented in the observer's Daily Notes. You should contact NMFS immediately.
3. All species discarded at sea must be included in the discard estimate.
4. An offload salmon retention count must be completed by the plant observer for all BS pollock deliveries. ***The vessel observer must assist the plant observer.*** See "BS Relief Guidelines for Working with the Plant Observer" on page 5-30.
5. At-sea discard of salmon is prohibited in the BS pollock CV fishery. Salmon discarded at sea must be documented on your Deck Form, in your Daily Notes and you must notify NMFS. Notification should take place the next time your vessel offloads or through inseason messaging if available. Salmon discarded at sea must be reported to the plant observer so they can include these salmon in their salmon retention report.
6. Any salmon found in your species composition sample or removed from the catch by a crew member must be placed in the RSW tank to be accounted for

during the offload.

7. Once you have collected the required FMA ID scale specimens and tagged salmon specimens (if the salmon is tagged) from salmon within your at-sea composition samples, the salmon should be placed in the RSW tank so that they may be accounted for at the plant during the offload salmon retention count. See "Salmon Data Collection" on page 12-9 for biological data requirements.
8. Document any at-sea discard of ***unsorted catch*** and notify NMFS immediately.
9. Any birds encountered during the offload will be attributed to your cruise/vessel. The bird event will be entered under the trip level with the vessel activity as fishing. Information on how to record bird data can be found on page 16-9 under "Completing the Bird Interaction, Activity, and Species Form".

BS Pollock Offload Salmon Retention Count

For all BS pollock CV deliveries a complete count during the offload for salmon must be completed by the plant observer and vessel observer.

The plant observer and vessel observer are both responsible for monitoring the entire offload for salmon bycatch. The plant observer is required to report the Salmon Retention Data. The vessel observer assigned to the delivering catcher boat is responsible for providing assistance to the plant observer. See "BS Relief Guidelines for Working with the Plant Observer" on page 5-34 and "Bering Sea Delivery Rules and Relief Guidelines for Observers" on page 11-5 for BS pollock delivery information.

Specimen data collected from salmon in the offload are reported along with salmon retention data by the plant observer.



Vessel observers must initial ALL data collected for the plant observer.

The plant is required to stop sorting fish during the salmon count and while biological specimens are collected. It is not acceptable for one observer to watch the sorting line while the other is counting salmon or collecting biological specimens from salmon.

See “Pollock Offload Salmon Monitoring, Sorting and Retention” on page 11-3 for salmon retention rules and duties at BS shoreside/floating processing facilities.

Coordinating With the Plant Observer

Meet with the plant observer before every delivery. At the first delivery, he or she will familiarize you with the processing operation and provide you with a Delivery Weight Verification Process explanation (see page 11-9). Both observers should discuss the following:

- Pre-offload meeting procedures.
- The best location in the plant to sample for salmon bycatch. BS pollock deliveries should not have after-scale salmon, but if encountered, after-scale should be documented and then added to the salmon retention data by the plant observer.
- The location of the salmon storage container.

This is also an opportunity for the two of you to arrange the schedule for monitoring the offload.



The delivery weight must be verified. You are responsible for knowing and documenting how all your data were derived!

Pre-Offload Meetings with Industry

Deck Loads/Live Tank Transfers and Interrupting Offloads: Pre-offload meetings are essential to ensure all Bering Sea pollock deliveries are monitored in their entirety for salmon bycatch. These meetings are expected to take place when a catcher vessel targeting BS pollock comes in with fish on deck, have fish in the live tank, or when an interruption of an offload occurs. See “Pre-Offload Meetings with Industry for Bering Sea Pollock Deliveries” on page 2-37 for further information.

BS Relief Guidelines for Working with the Plant Observer

Monitoring the pollock offload is a shared duty between the plant observer and vessel observer, with each expected to monitor 50% of the offload. Relief provided by the vessel observer is to allow the plant observer to perform other duties. The plant observer may need assistance with collecting salmon retention and biological samples. Follow these guidelines for monitoring the offload:

- Both the plant observer and vessel observer are responsible for ensuring the offload is 100% monitored.

- Observers on catcher vessels delivering BS pollock are responsible for being present and available to assist the plant observer for the entire duration of their offload.
- The vessel observer *must* be present at the beginning and end of each offload to assist the plant observer as needed. The vessel observer is not required to be present if their assigned vessel leaves to fish at the end of the offload. The vessel observer may assist with the collection of salmon retention and biological data.
- Before your offload begins, you should meet with the plant observer to coordinate the offload schedule to ensure the offload is monitored 100% and to work out a fair break schedule. When deciding on the schedule it is important to keep in mind other duties for both the plant and vessel observer.
- As a general rule, the plant observer should take the first shift monitoring the offload.
- During the offload, vessel observers should be aboard their vessel and available to monitor the transfer of fish from the live tank or deck load to the RSW tank, or to complete a partial offload if needed. This will be established during the pre-offload meeting which the vessel observer must attend.
- The vessel observer and plant observer each monitor about 50% of the offload. This will allow the plant observer to complete other plant duties. The plant observer may need their relief at any time within the offload. Keep in mind that your offload may have just started but the plant observer may have been on the sorting line during the last 2-3 hours of the previous offload, so may need their break immediately.
- Observers on break or otherwise not monitoring the sorting of catch must check on the observer monitoring the catch a minimum of once every two hours, unless prior arrangements were made between the plant and vessel observer (more frequent breaks for colder weather, etc.).
- The vessel observer is not to perform plant duties not directly related to monitoring their offload for salmon.
- Relief periods must be recorded in your Daily Notes and on the Deck Form (by the plant observer or vessel observer).

These guidelines for assisting the plant observer are minimums. *Observer actions resulting in the offload not being 100% monitored will reflect poorly on the observer's work performance evaluation.* It is your responsibility to work out a fair schedule with your fellow observer. Both parties should remain flexible and professional. The assistance given (relief and/or assistance with collecting biological data) must be recorded in your Daily Notes and on the offload Deck Form.

See "Bering Sea Delivery Rules and Relief Guidelines for Observers" on page 11-5 for additional offload guidelines.



If any of your offload is missed, document the circumstances and contact NMFS immediately.

Gulf of Alaska Pollock Catcher Vessels

Observers aboard pollock catcher vessels will complete at-sea composition samples just as they do in every other trawl fishery. In addition to sampling at sea for species composition, observers assigned to GOA pollock catcher vessels must monitor the delivery for salmon bycatch (also referred to as the offload salmon retention count). The pollock fleet is required to deliver all salmon to the processing plants. All salmon delivered must be made available for the observer to count, identify to species, and to collect biological information. The Observer Program only collects salmon retention data from observed deliveries.

GOA Pollock Sample Duties

A few specifics about CV duties for GOA pollock include but are not limited to:

- All pollock hauls must be sampled. In the rare event that a haul is not sampled you must document the reasons in the Daily Notes section of your logbook. Contact NMFS immediately upon returning to shore if you were not able sample all hauls.
- Collect the required biological data from salmon within your at-sea composition sample and place the salmon in the RSW tank. See "Salmon Data Collection" on page 12-9 for biological data requirements.
- At sea discard of salmon in the GOA directed pollock fishery is prohibited. Any discard of salmon or of unsorted catch must be documented and reported to NMFS immediately. This includes the dumping of unsorted catch.

- Any salmon found in your species composition sample or removed from the catch by a crew member must be placed in the RSW tank to be accounted for during the offload.
- All pollock hauls must have a discard estimate entry on the OHF. Include all species discarded at sea in the haul discard estimate.
- Salmon discarded at sea in the GOA must be included in your salmon retention data for the trip.
- An offload salmon retention count must be completed by the vessel observer for all GOA pollock deliveries to a plant.
- Vessel observers are not required to monitor deliveries to a tender vessel.
- Any birds encountered during the offload will be attributed to your cruise/vessel. The bird event will be entered under the trip level with the vessel activity as fishing. Information on how to record bird data can be found on page 16-9 under "Completing the Bird Interaction, Activity, and Species Form."
- Observers on board GOA pollock catcher vessels must report salmon species and numbers on the Salmon Retention Form in ATLAS. See "Salmon Retention Data in the Pollock Fishery" on page 12-16 for more information about retention data requirements.

Note that if you are on a catcher vessel that receives a codend from another vessel, you do not sample that codend at the plant. The observer on the vessel that caught the fish is responsible for recording all information on their haul forms and acquiring fish ticket information for the transferred haul.

GOA Vessel Observer Offload Salmon Retention Count

An offload salmon retention count means you will be present on the sorting line at all times while fish are running and will sort or monitor the sorting of all salmon from the delivery. In the GOA, the vessel observer is responsible for sorting salmon during the delivery and reporting the salmon bycatch data on the Salmon Retention Form. The offload salmon retention count is always required even in the rare event that not all hauls were sampled at sea. If you miss part of your offload, continue to monitor the remaining portion of

the delivery. Make a note on the Deck Form that part of the offload was missed and record the circumstances in your Daily Notes. Inform Observer Program field personnel at your earliest opportunity. See “GOA Vessel Observer Offload Salmon Retention Count Guidelines” on page 12-18 for GOA Salmon Retention instructions and guidelines for completing the offload Deck Form.



The delivery weight must be verified. You are responsible for knowing and documenting how all your data were derived!

GOA Pollock High Salmon Bycatch Deliveries

If you suspect that your GOA pollock offload has high salmon bycatch notify your employer as soon as possible, preferably before your offload begins, as you may have several hours of additional specimen collection once your offload has ended. An indicator of a potential high salmon bycatch event would be the presence of salmon in your at-sea species composition samples. Your employer may be able to coordinate assistance. Once at the plant, notify plant personnel as they may need to provide extra sorters or space for you to store salmon. If you are delivering to an AFA plant inform the plant observer as they may be able to assist with the offload salmon retention count and genetics collection.

GOA Plant: Pollock Deliveries

With no plant observer present at GOA plants, the vessel observer will be solely responsible for monitoring their entire pollock offload. See “GOA Vessel Observer Offload Salmon Retention Count” on page 5-31 for instructions.

Each plant is different and you will need to spend some time learning the operation. You will need to seek out this information yourself.

In Kodiak, your contractor or Observer Program staff may arrange a tour of the plants to familiarize you with the pollock offload procedures. If no tour is available and you know the plant you will be delivering to, take the time before you embark on your vessel to familiarize yourself with the sorting area and where you will be monitoring the offload to complete the salmon retention count.

Plant personnel may be available to show you where to monitor the offload and may be available to answer questions. Often this will be the dock foreman or another dock worker.

For all pollock deliveries, you will need to establish the following when you deliver:

- Identify key personnel including someone at the sorting area to bring any concerns to during the offload. Plants may establish an observer liaison. The liaison should be your go-to for all questions and concerns at the plant.
- Establish good communication with plant personnel at the very beginning and work to maintain this to collect quality data. Always notify plant personnel when sampling is complete so that they may dispose of the salmon.
- Familiarize yourself with the areas where after-scale salmon may be found as you may need to check this area during and immediately after your offload.
- Set up communications for the delivery schedule. Often this will be handled by your vessel, but it is helpful to communicate with the plant regarding offload schedule, especially if there is a backup of several days before your actual offload time.
- Familiarize yourself with the flow of fish from the vessel to the sorting area inside the plant. Make sure to note in your logbook the sorting process and how and where you get your salmon. Illustrate this in your sampling area diagram pages in your logbook.

GOA Breaks During the Pollock Offload

The average offload time for a GOA pollock delivery is 3-5 hours. It is rare that the plant will be offloading or “running fish” non-stop the entire time. There will be breaks during the offload when the plant switches tanks on the vessel, changing shifts or when the plant’s fish holds are full. These breaks can range from 5 minutes (for a shift change) to several hours (when plant tanks are full). These short breaks are an excellent time for you to collect genetic samples from salmon they have set aside. The plant may re-start the offload with little or no notice, so you must be sure you are at the sorting line when this happens. GOA plants often restart the offload earlier than scheduled. You are expected to monitor the entire offload.

GOA Plant After-Scale Salmon

The salmon that make it past the sorters are referred to as “after-scale” salmon because it made it past the sorters and was weighed as pollock and sorted “after the scales.” The “after-scale” area is where factory workers will set aside bycatch that was not sorted out from the belts and made it into the factory. After-scale salmon occur during

the offload, but often will not be available until several hours after the offload is complete and the entire delivery has been processed.

After-scale may occur when:

- You are unable to sort through the catch because fish are running too fast or too deep on the belts.
- When fish are run into a tank where you have limited access to the belts.
- When no-one is on the line to sort salmon from the belt.

If you suspect salmon are getting past your sorting area, continue to sample the offload. If you see salmon get by but you cannot access them, record these as salmon unidentified in your salmon retention data and document the reasons behind the unidentified salmon in your sample.

GOA Pollock Offload Monitoring: Verifying After-Scale Salmon

Before being included in your retention data you must be able to ensure and verify that any after-scale salmon found while your vessel is offloading actually came from your offload.

If you can verify that they were from your vessel, include them in your retention counts and collect biological data from them following protocols in “GOA Vessel Observer Offload Salmon Retention Count Guidelines” on page 12-18.

You may encounter several scenarios when you will not be able to be certain that after-scale salmon are from your offload.

- Sometimes a plant will be processing a previous offload while your vessel is offloading. Any after-scale salmon from these other offloads should not be included in your salmon retention count since they did not come from your vessel.
- Check if the plant started processing your fish and no other vessel’s fish were being processed simultaneously. If another vessel was being processed then do not collect data from the after scale salmon (as you cannot guarantee they were your vessel).
- If your offload is completed and another offload is taking place while you are finishing your collection of salmon biological data, do not include any additional

after-scale salmon in your salmon retention count and do not collect biological data. You cannot be certain that they came from your vessel offload. Document this in your daily notes.

Follow these guidelines when monitoring your offload:

1. Before your offload begins, identify the areas where plant personnel will set aside after-scale salmon that have been missed during the offload. This can be done by asking available plant personnel to show you where these areas will be.
 - If you find salmon in the after-scale area before the offload begins, note these and document the total number. These should *not* be included in your salmon retention count.
2. During the offload, check after-scale salmon areas during breaks in processing.
3. Once the offload is complete(all the fish from your vessel have been removed) check the after-scale area for salmon.
 - If you do not encounter any salmon during your offload:
 1. and there are no after-scale salmon then your offload is complete and you can leave the plant.
 2. and there are after-scale salmon that you can verify are from your offload, collect data from these salmon. Repeat this process until there are no longer verifiable after-scale salmon. Your offload is complete when you have checked for after-scale and there are none.
 - If you encounter salmon during your offload:
 1. Check the after-scale area before you start collecting biological samples from these salmon. If there are salmon and you can verify they came from your sample, take them and return to your offload.
 2. Once you have finished collecting samples from all of your salmon, check the after-scale area once more. If there are no after-scale salmon, your offload is complete.
 3. If there are any new after-scale salmon and you can verify they were from your offload, collect

samples from the salmon.

4. Continue to check for after-scale. Your offload is complete when you check after-scale and there are no salmon remaining from your offload.

After you have checked the after-scale area and there are no more salmon, you have completed your offload data collection and you may return to your vessel. Once you have left the offload you can no longer verify any after-scale salmon came from your vessel's offload. Inform the plant you have completed your offload duties and they do not need to hold any more salmon for you. Document any instances where, after leaving the plant, you were notified by the plant of potential after-scale salmon from your offload. Remind plant personnel that these salmon need to be recorded on the fish ticket for the offload and you will not be collecting any additional data from these fish.

Document any discrepancies you may find between your salmon retention counts and the fish tickets. *Do not change any salmon retention numbers to match the fish tickets.*

GOA Pollock Vessels Delivering to AFA Plants

Your duties will remain the same regardless of whether or not a plant observer is present. You are ultimately responsible for your salmon retention data.

Coordinating With the Plant Observer at an AFA Plant

When possible, meet with the plant observer before every delivery. When the plant observer is available he or she will familiarize you with the processing operation and provide you with a Delivery Weight Verification explanation (see page 11-9). Both observers should discuss the following:

- The best location in the plant to sample for salmon bycatch as well as the location to find and check for after-scale salmon.
- The plant's procedure for salmon sorted from the belt.
- The location of the salmon storage container.
- How to obtain the delivery weight and after-scale salmon numbers.

This is also an opportunity for the two of you to arrange the schedule for monitoring the offload.

GOA Relief Guidelines for Working with the AFA Plant Observer

The vessel observer is responsible for the pollock offload salmon retention count for GOA pollock. If a plant observer is assigned to the plant, you should make arrangements to have the plant observer give you a break from sampling. The plant observer should meet your vessel up on arrival for delivery. Discuss when you want a break and agree upon a reasonable schedule with the plant observer. The plant observer will have other sampling duties, so it is important to be flexible when arranging breaks. Breaks should follow the same 50/50 guidelines as for Bering Sea pollock deliveries, however the vessel observer is expected to take the first shift for their deliveries. Refer to the plant section for more detailed offload break guidelines ("Bering Sea Delivery Rules and Relief Guidelines for Observers" on page 11-5).

Ask the plant observer what the plant would like you to do with the salmon once you are finished with them.

The entire offload must be monitored, therefore you cannot leave the sorting area at any time fish are running unless the plant observer takes over! The plant observer, or dock personnel, should be able to give you an estimate for when your offload will begin. Delivery schedules are tentative, and can change with little notice, so stay in touch with your vessel to ensure you don't miss part of the delivery. If you do miss a portion of your offload, continue your offload salmon retention count. You must notify your inseason advisor or NMFS field staff, and document the reason and amount of time missed in your Daily Notes.



It is unacceptable to miss any portion of an offload. If any of your offload is missed, document the circumstances and contact NMFS immediately.

Finishing an Offload Salmon Retention Count

If your vessel completes a delivery and is going back out to sea before you are done with all your offload salmon retention count duties *you must stay at the plant and finish all required duties.* If you suspect this may occur, contact your employer as they may need to make coverage arrangements. If no plant observer is available you must complete all assigned duties. Notify the Observer Program and your employer.

You should not embark on another trip, be sent to another assignment or to your final debriefing prior to the completion of your offload salmon retention count and collection of biological specimens. It is your employer's responsibility to ensure that this doesn't happen. If you are put in this situation, contact the Observer Program as soon as possible.



By federal regulation, pollock catcher vessel observers must not be assigned to another vessel or sent to debriefing prior to completing their offload sampling duties.

When There are No Salmon Encountered in the GOA Offload Salmon Retention Count

On rare occasions you will monitor an offload and not encounter any salmon. Knowing that there are no salmon in an offload is just as important to fisheries managers as knowing how many there were.

To capture these data on a Deck Form, record the date of the offload, your cruise number, vessel permit and offload number in the header portion of the form. Leave the total delivery weight empty. On the Deck Form used for the offload record the 5 salmon species with zero for the number found. Enter salmon retention data for the haul as per the Salmon Retention Form protocols on page 12-19 of the Prohibited Species chapter.

CATCHER VESSELS OPERATING AS TENDERS

If you are on a catcher vessel that receives fish from another vessel, do not collect any sampling data from these fish. If there is an observer on the vessel that caught the fish, they are responsible for sampling the catch. Refer to "Trawler Operating as a Tender Vessel" on page 2-6 for more information on observer duties when deployed to a tender vessel.

OBSERVERS DELIVERING TO MOTHERSHIPS

It is unusual for catcher boats delivering to a mothership to carry an observer. If you find yourself aboard a catcher boat delivering to a mothership your duties will depend on how the fish are being delivered.

1. If the haul is delivered as a codend, the mothership observer is completely responsible for recording and sampling this haul. Do not record this haul on your

Vessel or Observer Haul Forms. It will be accounted for by the mothership observer. Your only duties are:

- Obtain haul information to give to the mothership observer.
- Monitor the haul back for marine mammal interactions.
- Monitor the haul back for bird interactions.
- Record non-fishing day positions for any day all codends are delivered to the mothership and no fish are brought on board your vessel.
- Record trip data.

If the captain usually gives haul information to the mothership, you must verify that all the mothership observers are receiving all the necessary information. *Report Marine Mammal and Seabird interactions at the trip level.*

2. If your vessel is dumping fish into RSW tanks, and then pumping the fish to a mothership, you should treat these hauls as if they were being delivered to a shoreside processor. Important reminders:

- You are responsible for recording and sampling these hauls and for completing all standard vessel observer duties and forms.
- For non-pollock hauls, obtain vessel and observer estimates and sample for species composition. For pollock hauls, observer estimates are not required. Obtain a vessel estimate and sample for species composition.
- Remember that salmon discards on pollock catcher vessels is prohibited.
- Collect length frequency and specimen data from sampled hauls. All data you collect will go on your forms, under your cruise number.

SALMON IN THE CATCHER PROCESSOR POLLOCK FISHERY

Catcher processors in the BS Pollock fishery operate under a salmon species catch limit similar to the shoreside CV fleet. Observers assigned to AFA pollock CPs, and AFA motherships must report salmon retention data on the Salmon Retention Form.

BS Pollock Catcher Processors/Motherships

One of your highest priorities aboard an AFA CP/ mothership is to collect salmon retention data. All salmon must be placed in the salmon storage container to be identified and counted for salmon retention. Refer to “Salmon Retention Data in the Pollock Fishery” on page 12-16 for specific protocols required for salmon retention monitoring and instructions on recording salmon retention data.

Requirements for AFA CPs and Motherships

End of Sorting Notification: You must arrange with the crew to be notified that the haul is nearing completion so you can be available to complete the final salmon retention count.

- *Be sure to let the crew know where to find you. Collecting salmon retention data is one of your highest priorities!*
- *The vessel is required to stop sorting fish during the salmon count and while biological specimens are collected.*

Salmon Storage Container: All AFA CP vessels and motherships have an approved storage location for salmon to be saved until the salmon retention count is completed by the observer, usually at the end of each haul.

Video Requirement: All AFA pollock CPs and motherships are equipped with a factory video monitoring system (also known as electronic monitoring or EM). The system is used to track salmon from the time it enters the factory to when it is placed into the salmon bin.

The observer may be fulfilling other duties and is not expected to observe the entire sorting of salmon from the flow of fish.

See “Salmon Data Collection” on page 12-9 for additional sampling requirements for salmon onboard your pollock CP.



Salmon bycatch numbers can be in the hundreds per haul during the summer months. Ensure you have enough Salmon genetic envelopes at the beginning of each trip to accommodate this data requirement.

Food Bank

Several vessels targeting pollock will retain salmon for the food bank. The percent retained for each salmon species will be a visual estimation based on your observations and/or guidance from factory personnel.

Aleutian Islands Pollock Fishery Guidelines

Participation in this small fishery is limited. Sampling requirements depend on vessel type and fishery status. *Contact NMFS for sampling instructions if you are on a vessel heading out to fish the Aleutian Islands pollock fishery!* In most instances, sampling will follow the BS pollock fishery protocols. See “Length and Specimen Priority List for Bering Sea/Aleutian Islands Vessels” on page 13-24 for length and specimen instructions.

HALIBUT IN THE TRAWL CP AND MOTHERSHIP NON-POLLOCK FISHERIES

Halibut bycatch in non-pollock trawl fisheries has the potential to impact industry’s ability to fully harvest their target species quotas. Regulations were enacted in 2020 that allow Catcher Processors and Motherships participating in non-pollock fisheries to sort halibut bycatch on the trawl deck in order to return them to the sea faster with the goal of reducing halibut discard mortality. The sorting and discarding of halibut on the trawl deck is referred to as halibut deck sorting.

Pre-Cruise Meetings: The vessel participant must provide the opportunity for a pre-cruise meeting. Use this meeting to cover the Deck Safety Plan, any vessel specific sampling challenges, and any other questions you might have.

Deck Sorting Safety Meeting and Deck Safety Plan

A Deck Safety Plan is a document which details procedures to be followed by the crew and observers in order to safely access and work on the trawl deck during halibut deck sorting. Observers must be provided with a copy of the Deck Safety Plan and review all of its contents with the vessel prior to embarking on a trip.

Vessels conducting halibut deck sorting must provide a deck sorting safety meeting and review all of the elements of the Deck Safety Plan prior to embarking on a trip any time any one of the following individuals boards the vessel;

- Observer(s)
- Vessel operator
- Key crew member that will be responsible for providing notification or reasonable assistance during halibut deck sorting.

Observers should use the deck sorting safety meeting to ensure they understand all components of the Deck Safety Plan. This meeting is also an opportunity to review the Halibut Deck Sort Sample Station Report, discuss the deck sort time limit, ask questions, clarify duties, and develop a plan with crew on how to best coordinate the sorting, data collection, and discard of deck sorted halibut. The observers must be provided with a copy of the Deck Safety Plan prior to embarking on a trip.

Halibut Deck Sorting Video Monitoring

Vessels conducting halibut deck sorting will be equipped with a video camera system recording images of the deck activities. The video system must be reviewed by the vessel operator once per calendar day to verify camera placement, camera view, and the system's ability to record and save the video data. At the beginning of each trip, the lead observer should ask the captain to notify him/her anytime the camera system malfunctions. Any issues with the video monitoring equipment should be brought to the attention of the inseason advisor.

Vessel Carrying Three or More Observers

Vessels conducting halibut deck sorting may elect to carry three or more observers. This is primarily done because having two observers on shift can allow the vessel to run fish over the flow scale in the factory while halibut deck sorting is occurring.

Have a discussion with the captain to determine the 12 hour period when the vessel would like to have two observers on duty. The observer team should work together to develop a fair and equitable schedule that meets the vessel's operational needs. Once this schedule is developed, the lead observer should provide it to the captain.

Changes to the schedule during a trip should be agreed upon by each of the assigned observers and the vessel. Notify your inseason advisor if issues arise due to scheduling, the need to make changes to schedules during a trip, or if you find yourself consistently working more than 12 hours in a 24 hour period.

Requirements for Non-Pollock Catcher Processors and Motherships Conducting Halibut Deck Sorting

Non-Pollock CPs and motherships must meet certain catch handling and monitoring requirements in order to participate in halibut deck sorting. See halibut deck sorting sample protocols for additional requirements on page 20-18.

Prior Notification: Vessel operators are required to notify the observer(s) on duty that halibut deck sorting may occur at least 15 minutes prior to bringing fish on board.

Time Limit for Halibut Deck Sorting: The amount of time the vessel may conduct halibut deck sorting is specified in the Halibut Deck Sorting Sample Station Certification Letter. Once the time limit has been reached, all deck sorting must cease, all halibut remaining on deck must be placed in the live tanks, and the observer may not facilitate any additional halibut discarding.

Halibut Deck Sorting Sample Station: The vessel must have a NMFS approved Halibut Deck Sorting Sample Station.

Weighing of Catch in the Factory While Halibut Deck Sorting is Occurring: Catch may not be weighed in the factory while halibut deck sorting is occurring unless there are three or more observers assigned to the vessel and two observers are on shift.

Visual Signal: During halibut deck sorting activities, vessel personnel must employ a visual signal in the factory to notify the crew that catch may not be run over the flow scale and weighed. The type of visual signal being used on the vessel will be defined in the Halibut Deck Sample Station Inspection Report. The visual signal is not required to be used when there are three or more observers assigned to the vessel and two observers are on shift.

Halibut Deck Sorting Pace: Vessel personnel may not pressure the observer to move halibut through the sampling process faster than the observer can handle. Contact your inseason advisor if this is occurring. The deck crew and the observer should work together at an efficient pace that allows for all halibut deck sort data collection to be completed in the allotted time.

Collecting Halibut Deck Sort Sample Data

This section describes the protocols for the collection of halibut deck sort species composition and viability data

Setting up the Halibut Deck Sort Data Forms Using Randomized Block Design Sample Table

Before fishing operations begin, pre-format the Halibut Deck Sort Data Forms using a Randomized Block Design Table. Ask the captain how many hauls they anticipate to retrieve during the trip and prepare enough forms based on this number. See “Figure 5-10: Setting up the Halibut Deck Sort Data Form using the 1 in 5 Random Block Design Table Example” on page 5-50. Follow these steps when setting up the Halibut Deck Sorting Data Forms:

1. Determine the start point in the 1 in 5 Randomized Block Design Table provided to you.
2. In the first block of five in the Halibut Deck Sort Data Form, shade the upper left hand box that is associated with the start point selected in step 1.
3. In descending order, continue to follow the sequence of random numbers on the 1 in 5 Randomized Block Design Table and shade the boxes in subsequent blocks of five on the front and back of the Halibut Deck Sort Data Form.

It is recommended to also pre-format Halibut Deck Sort Data Forms using the 1 in 10 Randomized Block Design Table and have them available on deck. The 1 in 10 table is used when a high abundance of halibut is expected in the haul.

Halibut Deck Sort Sampling Protocols

Once the vessel has determined that halibut deck sorting will occur for a specific haul, all halibut deck sorting must be carried out under the direct supervision of an observer on duty. The vessel must comply with the following catch handling requirements:

- Fish may not be spilled from the codend or sorted through until the observer is present on deck.
- During the halibut deck sort process, it is prohibited to sort or discard any species other than halibut.
- All deck sorted halibut must be discarded by the observer.
- Halibut deck sorting time should not exceed the time limit specified in the Halibut Deck Sorting Sample

Station Certification Letter.

Follow the halibut deck sort sampling guidelines as described below:

1. Once the codend is opened, record the time of day (Alaska Local Time) on the Halibut Deck Sort Form and start the NMFS issued stopwatch.
2. The deck crew will begin to sort halibut and pass it on to the observer. There must be one single pathway for halibut to move through the observer’s deck sample station and only one point of discard after the observer data collection point.



Document marine mammals sightings and interactions you observe during halibut deck sorting activities.

3. Using pre-formatted Halibut Deck Sort Data Forms, implement the randomized block design to select which halibut is measured and assessed for viability in each sampling block. All other halibut within the block are tallied and discarded (see “Figure 5-11: Example of Documenting Halibut Deck Sort Data on a Flatfish CP” on page 5-51).
4. If you are unable to measure and assess the randomly selected halibut within a sampling block, measure and assess the next halibut, then continue following the original sampling sequence on your Halibut Deck Sort Data Form. Document the circumstances on the Deck Form and in your Daily Notes.
5. No other halibut should be discarded while randomly selected assessment fish are sampled.
6. Halibut that have been selected for lengths and viability assessment but are too large to be measured on the measuring table should be measured using the NMFS issued measuring tape. Ensure that this is done in a safe area in the trawl alley in accordance with the vessel’s Deck Safety Plan and the Halibut Deck Sorting Sample Station Certification checklist.
7. Both the crew and the observer must carefully handle halibut throughout the halibut deck sort process to minimize potential injury to the fish. ***Halibut should not be lifted by the caudal peduncle.***
8. During the halibut deck sorting process communicate with the deck crew to ensure they sort halibut at a

pace that allows you to collect all required data.

9. Once halibut deck sorting activities stop, record the time sorting ended on the Halibut Deck Sort Form and stop the NMFS issued stopwatch.



Once the halibut deck sorting time limit is reached, any halibut remaining on deck must go into the live tanks with the rest of the catch. Do not continue to sample or discard halibut.

10. Add the halibut deck sort data to the species composition section (sample 9000) of your Halibut Deck Sort Data Form. Enter the total number of assessed halibut and leave the weight field blank. You will update this field with the weight of assessed halibut once you have entered these data in ATLAS. On a separate line enter the total number of unassessed halibut with a weight of 0 (see Figure 5-11 on page 5-51).
11. Enter the total number of assessed and unassessed halibut in the Halibut Deck Sort tab in ATLAS (see ATLAS Halibut Deck Sort Form instructions on page 18-22). After you enter these data in ATLAS, remember to update the weight of the assessed halibut.

Hauls With Low Halibut Abundance

At the beginning of the halibut deck sort, if it is evident that halibut abundance is low when the codend is opened, measure all deck sorted halibut up to the first randomly selected assessment fish.

- **If you reach the first randomly selected assessment halibut:** Record halibut deck sort data as described in the Halibut Deck Sort Sampling Protocols. Do not enter the additional halibut length data into ATLAS. Only enter length data for randomly selected assessment halibut.
- **If you do not reach the first randomly selected assessment halibut:** Halibut Deck Sort Data will be recorded and entered in ATLAS based on how many lengths you were able to collect:
 - Lengths taken from *all* unassessed deck sorted halibut: Add the total number of unassessed halibut to the species composition section (sample 9000) of your Halibut Deck Sort Data Form and leave the weight field blank. You will update this field with the weight of unassessed halibut once you have entered

these data in ATLAS.

- Lengths taken from *some or none* of the unassessed deck sorted halibut: Add the total number of unassessed halibut with a weight of 0 to the species composition section (sample 9000) of your Halibut Deck Sort Data Form. Enter these data in the Halibut Deck Sort tab in ATLAS (see 18-22). Notify your advisor and ask for a halibut trip average weight. You will need to update the discard weight and observer estimate for this haul.



Contact your inseason advisor if you are unable to obtain halibut weight data in a Halibut Deck Sort Sample.

Hauls With High Halibut Abundance

At the beginning of the halibut deck sort, if it is evident that halibut abundance is high, you may use a pre-formatted Halibut Deck Sort Data Form using the 1 in 10 Random Sample Design Table. Examples of indicators of potential high halibut abundance are: the last haul had high halibut numbers and the vessel is fishing in the same area, when the codend was opened there were a lot of halibut visible. *Do not switch from a 1 in 10 to a 1 in 5 pre-formatted Halibut Deck Sort Data Form. When this occurs, the halibut deck sort data collected at the higher rate (1 in 5) cannot be used in its entirety.*

Occasionally, a high halibut bycatch event may not be evident when the codend is opened. In these situations you may switch to the 1 in 10 pre-formatted data form after halibut deck sort data collection has begun. When this occurs, data collected using the 1 in 5 table will be corrected during debriefing to match the 1 in 10 rate. *It is important to determine halibut abundance early in the halibut deck sort process, preferably when the codend is opened, or within the first 25 halibut. Plan your sample and sample your plan!*



All deck sorted halibut weights must be added to the final flow scale weight and to the estimated discard weight for each haul in which halibut deck sorting occurred.

Marine Mammal Feeding on Discarded Catch Interactions During Halibut Deck Sorting

During halibut deck sorting it is important to monitor for the presence of marine mammals feeding on deck sorted halibut.

- From a safe spot adjacent to the Deck Sorting Sample Station, look for the presence of marine mammals before halibut deck sorting begins.
- If marine mammals are present, verify if they are feeding on deck sorted halibut. During halibut deck sorting, periodically step away from the Halibut Deck Sorting Sample Station to monitor for marine mammal interactions. Do not assume that the presence of marine mammals is an indication that they are feeding on discarded halibut. Marine mammals feeding on deck sorted halibut must be observed. The only exception is when the marine mammals remain directly below where the deck sorted halibut exit the vessel for the entire duration of the deck sort process. If you determine that the marine mammals are feeding on deck sorted halibut, follow these guidelines:
 - Continue collecting halibut deck sort data.
 - Record the marine mammal interaction raw data on a haul by haul basis on each Halibut Deck Sort Data Form.
 - Notify the vessel that marine mammals are feeding on deck sorted halibut being discarded and that the halibut viability data for that haul may be impacted. It is up to the vessel to determine if deck sorting will continue. Clearly document these discussions in your daily notes and inform your inseason adviser that marine mammals are feeding on deck sorted halibut.
 - Enter these marine mammal interactions in the Marine Mammal Data form in ATLAS at the haul level. Code the interactions as “feeding on discarded catch”. If you determine that the same group of marine mammals continue feeding on deck sorted halibut for multiple consecutive hauls, these interactions can be entered at the trip level.
- Provide the updated halibut deck sort data to the vessel so that they can update their ELB. Providing these data to the vessel should not interfere with your regular duties.



Once you have completed the halibut deck sort data collection and you have entered these data into ATLAS, provide the final halibut deck sort data to the vessel so that they can update their ELB. Providing these data to the vessel should not interfere with your regular duties.

LIMITED ACCESS PRIVILEGE PROGRAM FISHERIES

In the Bering Sea and Gulf of Alaska, observed vessels will be participating in either Limited Access or Limited Access Privilege Program fisheries (LAPP). Vessels fishing LAPP fisheries are specifically regulated by the American Fisheries Act (AFA), Community Development Quota (CDQ) Program, the Pacific Cod Trawl Cooperative (PCTC), the non-AFA trawl catcher/processor LAPP in the BSAI (referred to as Amendment 80), the Central GOA Rockfish Program, and/or laws associated with the Groundfish Retention Standards (GRS) program in the BSAI.

The majority of sampling protocols are the same regardless of whether the vessel is fishing limited access or LAPP. You should be aware of some specific sampling protocols for vessels fishing in the LAPP fisheries. Specific policies are noted by vessel type and fishery below.

Sample Sizes in LAPP Fisheries

Sample size guidelines and determining factors discussed in previous sections of this chapter are applicable to the LAPP fisheries.

AFA/CDQ Pollock Catcher Vessels

See “Salmon in the Shoreside Pollock Fishery” on page 5-28. Pollock catcher vessels operating in an AFA co-op or fishing CDQ have the same sampling protocols as limited access pollock fisheries (see previous discussions on sampling mechanics and designs on catcher vessels). These vessels will not have an observer sampling station or motion compensated platform scale. Halibut Prohibited Species Quota (PSQ) and crab PSQ may be discarded at sea after you sample it.

PCTC & CDQ Non-Pollock Trawl Catcher Vessels

Trawl catcher vessels fishing for Pacific Cod in the BSAI, will most likely participate in the PCTC. Few non-pollock trawl catcher vessels have participated in CDQ fisheries. This may be because their catch is typically diverse and bycatch rates can be very high. These catcher vessels participating in PCTC or CDQ fisheries, will not have a certified observer sampling station or MCP scale. The vessel must provide space on deck for you to sort and store samples and a place to hang your scale. Finally, prohibited species must be discarded by the vessel after

you have had an opportunity to sample those species. Inform the plant observer of any at sea discards.

For each haul, obtain observer estimates using codend or bin volume estimates. Densities should also be taken for each haul. If an observer estimate is not possible, report the vessel's estimate only and leave the observer estimate blank.

Since the catch is usually diverse, you will most likely take small samples at sea for all species. In rare cases, with very small hauls, you may be able to sample the entire catch. As the vessel observer on a non-pollock trawl catcher vessel you have no duties at the plant other than notifying the plant observer of any at sea discards and obtaining a total delivery weight for the delivery. It is the plant observer's responsibility to monitor the offload.

AFA, CDQ and Non-AFA Limited Access Groundfish on Trawl Motherships and CPs Fishing in the BSAI

Regardless of the fishery, trawl CPs and motherships fishing in the Bering Sea or Aleutian Islands who are participating in the limited access privilege fisheries are required to carry two observers, have the ATLAS program, a NMFS certified observer sampling station, a flow scale and a MCP scale. The vessel is required to test the flow scale daily (see "Flow Scale Testing" on page 2-31).

All catch landed by the vessel must be weighed on the flow scale and hauls cannot be mixed. Your duties and responsibilities will be the same no matter what species the vessel targets. The vessel's operating requirements will be the same as well, regardless of the species fished.

It is your responsibility to test the platform scale daily (see "Platform Scale Testing" on page 2-30). It is common for both AFA and non-AFA trawl CPs to participate in a variety of fisheries during any given trip. If catch coming onboard may be designated as CDQ, the vessel should provide you advance notice, but the vessel has up to two hours after completion of weighing all catch in the haul to officially designate a tow as CDQ in their logbook. As the observer, you should only be concerned with whether they treat potential CDQ catch appropriately and whether the catch is designated as CDQ when you record your catch weight information from the vessel's logbook.

Since motherships must coordinate their record keeping with the delivering vessel, they cannot designate catch as

potential CDQ and then change it to non-CDQ. Their catch should be designated prior to landing it. Check the logbook information carefully when filling out your haul forms, since a vessel may be fishing for several CDQ groups or participating in multiple fisheries.

GOA SHORESIDE TRAWL FISHERIES

The GOA shoreside trawl fleet presents challenges on many levels. The entire fleet is under 120 feet in length. Fisheries are generally short and intense. These two factors require that observers often shuffle between boats in a relatively short time period. This doesn't allow for settling into a routine on a particular boat, however, most of the boats are similar in size and deck layout making sampling similar on each boat. The following are some guidelines to assist you.

Sampling Effort

The majority of the time observers are able to sample all hauls retrieved by the vessel. You are expected to sample all hauls if the vessel hauls three or less per day, and all pollock hauls must be sampled. As with all boats, it is important for you to talk with the captain prior to the start of fishing to determine sampling challenges on that particular vessel (i.e., safe areas to sample, how to collect samples, where to stand during haulback, etc.). Due to the short nature of many GOA fisheries, each boat may make only a few hauls during each fishery and it is critical that observers sample as many hauls as possible. In these short fisheries, an observer missing a single haul on a particular vessel may reduce the fleet sample level drastically. The shallow water flatfish fishery may be the exception to sampling all hauls and may require you to use the RST or RBT. See "Selecting Hauls to Sample" on page 2-18.

The data you collect are vital for the management of the marine resource, but remember that safety is always your first priority!

Catch Estimates

Generally observers use codend measurements to estimate catch volume in these fisheries. The deck layout may be complicated and access to take measurements may be dangerous. In order to safely measure a codend do the following:

- Work with the captain and enlist the crew's help early on.

- Pre-measure the deck before fishing starts.
- Clearly explain your expectations and what you need.
- Be open to their suggestions to help you obtain codend measurements.

Bin volume measurements for catch estimates are often not an option due to low catch volume. Catch estimates are not required in the GOA pollock fishery unless the vessel is heavily sorting at sea. Use your baskets for making density estimates, unless you have an easily defined container for use. If using a container other than your baskets (a fish tote), the depth of fish must be at least 20-30 cm.

GOA Trawl Catcher Vessels: Determining Target Species

It is possible that vessels in the GOA trawl fisheries may change their target fishery during a trip when conditions favor other species. To ensure that you are able to collect all the needed data for a particular fishery please follow the steps listed below when deploying to a trawl catcher vessels in the GOA.

- Before fishing begins, it is a reasonable request to ask the captain what the intended target fishery will be for the trip. Inform the captain that your sampling duties change depending on what the target species will be, and not having this information, may interfere with your ability to collect required data. Sample the entire trip following the protocols for the species the captain says he will be targeting.
- If the captain plans to target pollock, you will be expected to complete all of your sampling duties during the trip for pollock catcher vessels in the GOA as outlined under “Gulf of Alaska Pollock Catcher Vessels” on page 5-31. These protocols include sampling all hauls and completing an offload salmon retention count.
- If the captain plans to target a species other than pollock, you will sample according to Observer Program protocols outlined in the manual for non-pollock hauls and trips. These would include observer estimates, and you are not required to complete an offload salmon retention count.
- If the captain does not declare a target species then assess the first haul for the predominant species. Base your sampling protocols for the remainder of the trip

on the first haul and document this situation in your logbook.

Random Sampling Design

Safe access to catch, space limitation, at-sea sorting, and weather all have implications in your ability to utilize an unbiased random sampling design on these boats. It is always preferred to obtain multiple random samples.

However, it is understood that in this fleet there may be many instances where you may only be able to obtain one non-random sample. If this is the case, you must document in your logbook the circumstances leading to opportunistic samples.

Following are some methods for collecting random samples in this fleet:

1. Sample from the trawl alley by dividing the area into spatial units. Randomly select a unit(s) from the trawl alley and transport all the fish in the sample unit to the sample area.
2. Sample from the trawl alley by dividing the population into units. Randomly select from the sampling units available to you by lifting a bin board to collect a sample.
3. Sample from a sorting belt. A few boats use sorting belts to run the catch for bleeding or for sorting. See “Simple Random Samples from the Codend or Conveyor Belt” on page 5-11 for instructions. **All catch** must go over the belt and any large species you see fall back down the incline belt **must be** accounted for in your species composition. If these two requirements cannot be met, you must choose another method.

Sampling on Trawl Catcher Vessels in the GOA Rockfish Fishery

Sampling strategies and methods in this fishery are no different than for catcher vessels participating in other bottom trawl fisheries. If you observe on a catcher vessel participating in the GOA rockfish trawl fishery, consider the following:

1. Participating vessels are required to carry 100% coverage when they are participating in this fishery, regardless of vessel size.
2. This fishery is limited, the allocated quota is relatively small, and observer deployments may be only a few

days at a time. It is critical that observers sample as many hauls as possible! Do not take the first haul off!

3. The ATLAS data entry program is required for all vessels participating in the GOA rockfish trawl fishery. ATLAS will be installed in the vessel's computer but without the ability to transmit from sea. You must enter data in ATLAS at sea, and transmit as soon as you arrive at the plant! See "Entering and Transmitting Data Using a USB Flash Drive" on page 18-28.

GOA Pollock Fisheries

See "GOA Pollock Sample Duties" on page 5-31 for detailed GOA pollock sampling instructions.

DECK FORM INSTRUCTIONS

The waterproof raw data forms provided by the Observer Program are meant to be taken out on deck. Never recopy raw data and always return to your debriefing interview with your original data. The Deck Forms are an important component of your data documentation. It is important to fill out the forms completely and legibly!



All raw species composition data collected by you must be documented on the Deck Form provided by the Observer Program.

Enter data line by line from the Deck Form directly into the ATLAS system. Line by line entry is easier to check and will speed up the debriefing process. There is one exception to this rule. When you enter salmon and crab species that have an associated sex, sum the lines of data on your Deck Form to enter these as a single line of data by sex into ATLAS (see Figure 18-27 on page 18-13).

The Deck Form is double sided with two sample blocks available on each side. The header information at the top of the Deck Form must be filled out and pertains to both sample blocks below it. *You cannot mix samples from two different hauls on a single side of the Deck Form.* You must maintain a separate set of forms for each vessel you are deployed to.



Maintain a separate set of forms for each vessel.

Multiple samples and subsamples taken within a haul should be maintained completely independent of each other with their own unique sample number

and sample block(s) on the Deck Form. If you have to combine samples later, simply check the circle next to "Combined?" for the affected samples (for information on combined samples see "Combined Samples" on page 5-26).

Note that the only time you will have subsample data on trawlers is when you have subsampled for two predominant species (see "Subsampling for Two Predominant Species" on page 5-20). Subsamples have a specific numbering system associated with them, explained on page 5-44. If there are two or more observers on a vessel, each observer must record their initials on the Deck Form next to each sample they collect.

Examples of completed Deck Forms can be found starting on page 5-47. *The following Deck Form rules must be followed on all vessels and all fields must be filled out completely.*

Date, Cruise, Permit: Enter the date (in mm/dd/yy format) the haul was retrieved. The date on this form must correspond to the retrieval information on the VHF Form. Your cruise number will be given to you during training or briefing, or by your employer. Vessel permits are listed on page A-31.

Haul No., Offload No.: For each sample taken within a haul, enter the haul number the sample came from and leave the offload number blank. Hauls can be numbered sequentially beginning with the number 1, or you can follow the captain's numbering convention *if the captain is not repeating haul numbers with each new trip.* Number offloads sequentially for the vessel, beginning with the number 1. Haul numbers and offload numbers must match entries on your Haul and Offload Forms.

Haul number and offload number must be unique for the vessel. If you disembark the vessel and then embark again at a later date, you can continue numbering the hauls from the number where you left off, continue with the captain's numbering convention (if s/he is not repeating haul numbers), or skip a few numbers (e.g., if you numbered hauls of the first trip 1, 2, 3, and 4, you could number hauls of the next trip as 11, 12, 13, 14).



Haul numbers do not have to be sequential (although it is easier if they are), but they do have to be unique for the vessel.

Page_ of_ for Vessel/Plant: For each vessel assignment Deck Form pages are numbered consecutively starting

with 1. All forms with raw data must be included in the total pages for the vessel/plant.

Page_of_for Haul/Offload: All Deck Forms associated with each individual haul/offload are numbered consecutively starting with 1 of “n” for the haul and it’s associated data. See examples in Figure 5-19 on page 5-59.

Sample number: Every sample taken from within a haul must have a unique identifying sample number. Number samples taken within a haul sequentially, starting with the number 1. You do not need to make sample numbers between hauls unique; you can start with the number 1 for the first sample of every sampled haul.

Subsample Number: For trawl sample data, the only time you will have a subsample block of data is when there are two predominant species in a sample. Subsamples must be numerically linked to the parent samples they came from. You do this by using a numbering convention designed specifically for subsamples: every subsample number must be three digits in length, with the first digit designating the parent sample from which the subsample came, and the next two digits indicating the number of that subsample for the parent sample. Subsample numbering convention is explained further below:

- The first subsample of sample number 1 for a haul should be numbered 101, the second subsample for sample number 1 of a haul should be numbered 102, the third 103, and so on...
- The first subsample of sample number 2 for a haul should be numbered 201, the second subsample for sample number 2 of a haul should be numbered 202, the third 203, and so on...
- The first subsample of sample number 3 for a haul should be numbered 301, the second subsample for sample number 3 of a haul should be numbered 302, the third 303, and so on...

Sample and Subsample Size: On trawlers, every sample and/or subsample must have a sample weight. Record the total weight of catch in your sample, in kilograms, and circle the “Kg” text.

of Sampled Hooks: Not used for trawl vessels.

Presorted: If the sample represents pre-sorted species, check the circle next to “Presorted” for the sample. See

page 5-22 for more information on accounting for pre-sorted species.

Combined: If the samples for a haul are going to be combined in the reported data, check the circle next to the word “Combined” for only those samples that will be combined. When these data are entered into ATLAS or on a paper form samples designated as combined are rolled up into a single sample entry. See “Combined Samples” on page 5-26 for a description of when samples must be reported as a “Combined Sample”.

Unable to Follow Design: No longer in use. If you have an older form do not make an entry in this field. When entering data into ATLAS, this field is labeled “Sampled As Designed”. Do not enter this field in ATLAS. It will default to “N” and should be left alone.

No Fish in Sample: Not used on trawl vessels.

Species: List each species encountered in the sample by their common name.

Sex: Tanner crab, king crab, and salmon should be listed separately by species and sex. Record an “M” or “F” for these species when sex is determined. Leave the sex field blank for any unsexed prohihs and for non prohibited species. Do not record sex codes for any other species even if they were sexed for length samples.

Number: Enter the number seen for each species listed. If you do not have a number for individuals seen of that species, enter a zero in the number field for that species. Use as many lines and columns as necessary for each species.

• If you subsampled for two predominant species, you must enter a zero in the number and weight column of the parent sample that included those species. *Number and weight information on the two predominant species is entered in the subsample(s) taken specifically for those two species.* Parent sample entries with a zero placeholder in the weight and number columns alert the database and data users to expect subsample data for the parent sample. See sample number 2 in Figure 5-8 (page 5-48) for an example of how to document number data in a parent sample that has a subsample associated with it. See subsample 201 Figure 5-9 (page 5-49) for an example of documenting subsample data.

• For decomposed fish (code 899) and miscellaneous items (code 900) you can enter the actual number of

items or, if counting individuals in these categories would be too tedious and time consuming, you may enter a zero in the number field for these individuals.

Weight: Enter the weight of each species written with a well defined decimal. Weights must be recorded to the nearest 0.1 kg or 0.01 kg. If you feel that your scale cannot be read accurately to the tenth, you must fill in at least a trailing zero. *Do not enter weights to more than two decimal places.* If a species in your sample was too small to weigh (e.g., one brittle star) *enter the weight as 0.01kg.*

For trawlers, all species in the composition samples must have an associated *actual weight* (with the exception of large items too big to be weighed which must have a zero in the weight field). If you do not have the weight for any given species, the sample data cannot be included in your data transmission. You may use the length/weight tables to determine the weight of Pacific Halibut, Longnose Skate, and Big Skate that exceed the capacity of your scales. For Pacific Sleeper Shark and Salmon Shark use the “Shark Length to Weight Tables” on page A-47 to derive weight. For Pacific Halibut use the “Halibut Worksheet” in ATLAS to derive weight. For Longnose Skate and Big Skate use the “Skate Length to Weight Table” on page A-49 to derive weight. To use these tables you must have an actual length. Estimates of lengths are not acceptable. Use as many lines and columns as necessary for each species.

- Remember that for subsamples, you enter zero in both the number and weight columns for the two predominant species. The weight and number information are captured by your subsample(s) for those species.

Percent Retained: Enter your rough estimate of the percentage of each species kept. Retention applies to organisms kept for any reason, including consumption on the vessel, processing, delivery, or for a home pack. Record the percent retained to the nearest whole number without the “%” symbol. Refer to “Estimating Percent Retained” on page 5-27 for more specifics regarding the protocol for documentation of percent retained.

Keypunch: In the spaces to the right of the word “Keypunch”, write the calculated sum for species number and species weight values you recorded for the sample. If your species composition sample has too many species to fit in one sample block, enter the total sums on the

keypunch line in the first block for the sample and leave the keypunch line blank for the second block used for the sample.

Keypunches are a valuable tool for staff who edit your data. If the keypunch value the computer calculates does not match the keypunch value you wrote down, staff know to double check for errors in the entries. If you are sloppy with your keypunch calculations, staff have to investigate each discrepancy. This is a waste of valuable time for both you and for staff. Ensure you double check your keypunch summaries!

Length, viability, injury, specimen, tally data, notes: Each sample block on the Deck Form has a blank area for recording sample specific data such as sex/length/weight information, specimen information, halibut assessments, notes pertaining to any biases to the sample, etc. Sex lengths and specimens must be clearly labeled with the species they are associated to. Make comments about anything unusual with the catch or your sampling technique for the haul. More complete descriptions of these notes should be documented in your log book. Making note of unusual occurrences on your species composition form will assist in the debriefing process, and help you distinguish one haul from others. *All raw data must be documented and clearly labeled!*

Tally K/P: Not used on trawlers. The K/P box is often used to initial your samples when working with another observer.

HALIBUT DECK SORT DATA FORM INSTRUCTIONS

An example of a completed Halibut Deck Sort Data Forms can be found on page 5-51. The following Halibut Deck Sort Data Form rules must be followed and all fields must be filled out completely.

Page_ of_ for Vessel: Halibut Deck Sort Data Forms should be grouped and numbered with all other Deck Forms for each vessel. All forms with raw data must be included in the total pages for the vessel.

Page_ of_ for Haul: Halibut Deck Sort Data Forms should be grouped and numbered with all other Deck Forms for each haul and are numbered consecutively starting with 1 of “n” for the haul and it’s associated data.

TRAWLER COMPOSITION SAMPLING : TRAWL DECK FORM EXAMPLES

Date, Cruise, Permit: Enter the date the haul was retrieved in mm/dd/yy format. The date on this form must correspond to the retrieval information on the VHF Form. Your cruise number will be given to you during training or briefing, or by your employer. Vessel permits are listed in the vessel's ELB.

Haul No.: Enter the haul number the halibut deck sort data came from.

Time Codend Opened: Record the time the codend is opened. All entries must be in Alaska Local Time (ALT). Use 24 hour time notations in four digits.

Time Sorting Ended: Record the time the halibut deck sorting activities stop. All entries must be in Alaska Local Time (ALT). Use 24 hour time notations in four digits.

Total Sorting Time: Record the total elapsed time of the halibut deck sorting activities. Total sorting time may be determined using a stopwatch or may be calculated.

- **S.W. (Stopwatch):** Start the stopwatch when the codend is opened and stop the stopwatch when halibut deck sorting activities end. Record the total sorting time to the nearest whole minute. Circle "S.W." if the stopwatch was used to determine total sorting time.
- **Calc. (Calculated):** Subtract the time codend was opened from the time the sorting ended. Record the total sorting time to the nearest whole minute. Circle "Calc." if a calculation was used to determine total sorting time.

Halibut Tally and Length/Viability Sample Blocks: Record length and viability data for the randomly selected assessment fish. Record a check mark for tallied halibut.

Sample number: The sample number for a halibut deck sort sample is 9000. This number is pre-filled on the Halibut Deck Sort Data Form.

Presorted: Halibut deck sort samples are pre-sorted samples. The Pre-sorted bubble is pre-filled on the Halibut Deck Sort Data Form.

Sample Size: The sample size for a pre-sorted sample is the Observer Estimate for the haul. Ensure the weight of all pre-sorted organisms are included in the Observer

Estimate. Record this weight as it appears on the Observer Haul Form.

Species: Record "halibut" in this field.



Only halibut may be recorded in a halibut deck sort sample. Any other organism pre-sorted on deck must be recorded as a separate pre-sort sample.

Sex: Do not determine the sex of halibut. Leave this field blank.

Number: Enter the number seen for each halibut record.

Weight: Enter the weight for each halibut record. Weights must be recorded to the nearest 0.01 kg.

Percent Retained: Enter your rough estimate of the percent retained of halibut for the haul. Retention applies to organisms kept for any reason, including consumption on the vessel, processing, delivery, or for a home pack. Record the percent retained to the nearest whole number without the "%" symbol.

Keypunch: In the spaces to the right of the word "Keypunch", write the calculated sum for the species number and species weight values you recorded for the sample.

TRAWL DECK FORM EXAMPLES

The following deck form examples illustrate how to properly record trawl species composition data.

DECK FORM

| | | | | | |
|---------|--------|--------|----------|-------------|---|
| Date | Cruise | Permit | Haul No. | Offload No. | Page <u>1</u> of <u> </u> for Vessel/Plant |
| 6/28/23 | 19999 | 5676 | 187 | | Page <u>1</u> of <u>3</u> for Haul/Offload |

| | | | |
|--|--------------------------------|--|---|
| Sample #: <u>4</u> | Sub-Sample #: | Sample Size: <u>123685.22</u> <small>Kgs Segments pots</small> | # of Sampled Hooks: |
| Presorted <input checked="" type="radio"/> | Combined <input type="radio"/> | | No Fish in Sample <input type="radio"/> |

| Species | Sex | # | Weight | % ret. | Length, viability, injury, specimen, tally data, measurements, bird observations, sample design, notes: |
|----------------------|-------------------------------------|----------|--------------|-------------------------------------|--|
| ----- KEYPUNCH ----- | <input checked="" type="checkbox"/> | <u>1</u> | <u>85.22</u> | <input checked="" type="checkbox"/> | Large Salmon Shark @ 192cm pre-sorted during dump 192cm = 85.22 kg (Salmon Shark L/W table) Flow Scale Wt = 123600 kg Presort = + 85.22 kg Total Catch Weight = 123685.22 kg |
| Salmon Shark | | <u>1</u> | <u>85.22</u> | <u>0</u> | |
| | | | | | |
| | | | | | |
| | | | | | |
| | | | | | |
| | | | | | |
| | | | | | |
| | | | | | |

Total Catch Weight must include the weight of all presorted items! Sample size for presorted items is always the Total Catch Weight.

P.P. Tally K/P

| | | | |
|---------------------------------|--------------------------------|--------------|---|
| Sample #: | Sub-Sample #: | Sample Size: | # of Sampled Hooks: |
| Presorted <input type="radio"/> | Combined <input type="radio"/> | | No Fish in Sample <input type="radio"/> |

| Species | Sex | # | Weight | % ret. | Length, viability, injury, specimen, tally data, measurements, bird observations, sample design, notes: |
|----------------------|-------------------------------------|---|--------|-------------------------------------|---|
| ----- KEYPUNCH ----- | <input checked="" type="checkbox"/> | | | <input checked="" type="checkbox"/> | Haul 187 - Haul Weight = 120MT Sample RN = <u>1</u> S/L RN = <u>2</u> FS/MCP 0 15 30 45 60 75 90 105 120MT |
| | | | | | |
| | | | | | |
| | | | | | |
| | | | | | |
| | | | | | |
| | | | | | |
| | | | | | |

It is helpful to record your sample frame on the Deck Form for quick reference.

Tally K/P

National Marine Fisheries Service/Fisheries Monitoring and Analysis Division Ver. 2016

Figure 5-7: Example of Presorted Sample Data From a Pollock CP

TRAWLER COMPOSITION SAMPLING : TRAWL DECK FORM EXAMPLES

DECK FORM

| | | | | | |
|---------|--------|--------|----------|-------------|--|
| Date | Cruise | Permit | Haul No. | Offload No. | Page <u>2</u> of _____ for Vessel/Plant |
| 6/28/23 | 19999 | 5676 | 187 | | Page <u>2</u> of <u>3</u> for Haul/Offload |

| | | | |
|---------------------------------|--------------------------------|---|---|
| Sample #: <u>1</u> | Sub-Sample #: | Sample Size: <u>15047.00</u> <small>Kgs Segments pots</small> | # of Sampled Hooks: |
| Presorted <input type="radio"/> | Combined <input type="radio"/> | | No Fish in Sample <input type="radio"/> |

| Species | Sex | # | Weight | % ret. | Length, viability, injury, specimen, tally data, measurements, bird observations, sample design, notes: |
|--------------------|-------------------------------------|------------|-----------------|-------------------------------------|--|
| -----KEYPUNCH----- | <input checked="" type="checkbox"/> | <u>210</u> | <u>15047.00</u> | <input checked="" type="checkbox"/> | |
| Pollock | | <u>0</u> | <u>14860.91</u> | <u>100</u> | Start: <u>0</u> P.P. End: <u>15047</u> Total Sample wt: <u>15047.00</u> Bycatch wt: <u>- 102.29</u> Pollock Subset: <u>- 83.80</u> wt. of Uncounted: <u>14860.91</u> Pollock |
| P. Cod | | <u>12</u> | <u>27.60</u> | <u>100</u> | |
| AK. Skate | | <u>2</u> | <u>19.60</u> | <u>0</u> | |
| Herring | | <u>12</u> | <u>3.54</u> | <u>0</u> | |
| Jelly fish | | <u>8</u> | <u>5.14</u> | <u>0</u> | |
| Flathead Sole | | <u>23</u> | <u>8.39</u> | <u>0</u> | |
| N. Rock Sole | | <u>25</u> | <u>10.50</u> | <u>0</u> | |
| Rock Sole U. | | <u>63</u> | <u>27.52</u> | <u>0</u> | |
| Pollock | | <u>36</u> | <u>45.20</u> | <u>100</u> | |
| Pollock | | <u>29</u> | <u>38.60</u> | <u>100</u> | |

Sampling for one predominant species. Following protocol, a subset sample was collected

All organisms collected in the subset sample must be counted, weighed and recorded

| | | | |
|---------------------------------|--------------------------------|--|---|
| Sample #: <u>2</u> | Sub-Sample #: | Sample Size: <u>15341.0</u> <small>Kgs Segments pots</small> | # of Sampled Hooks: |
| Presorted <input type="radio"/> | Combined <input type="radio"/> | | No Fish in Sample <input type="radio"/> |

| Species | Sex | # | Weight | % ret. | Length, viability, injury, specimen, tally data, measurements, bird observations, sample design, notes: |
|--------------------|-------------------------------------|------------|--------------|-------------------------------------|---|
| -----KEYPUNCH----- | <input checked="" type="checkbox"/> | <u>104</u> | <u>41.06</u> | <input checked="" type="checkbox"/> | |
| Pollock | | <u>0</u> | <u>0</u> | <u>100</u> | Start: <u>45202</u> P.P. End: <u>60543</u> Sampling for two predominant species. Following protocol, a subsample will be collected Flow Scale passed on third test |
| P. Cod | | <u>0</u> | <u>0</u> | <u>100</u> | |
| Rex Sole | | <u>1</u> | <u>.48</u> | <u>0</u> | |
| Flathead | | <u>73</u> | <u>17.11</u> | <u>0</u> | |
| Arrowtooth | | <u>20</u> | <u>10.01</u> | <u>0</u> | |
| AK. skate | | <u>1</u> | <u>5.70</u> | <u>0</u> | |
| Jelly fish | | <u>6</u> | <u>1.98</u> | <u>0</u> | |
| Chinook | <u>M</u> | <u>2</u> | <u>3.67</u> | <u>0</u> | |
| Chinook | <u>F</u> | <u>1</u> | <u>2.11</u> | <u>0</u> | |

Sampling for two predominant species. Following protocol, a subsample will be collected

Flow Scale passed on third test

Figure 5-8: Example of Sample Data for One and Two Predominant Species on a Pollock CP

DECK FORM

| | | | | | |
|---------|--------|--------|----------|-------------|--|
| Date | Cruise | Permit | Haul No. | Offload No. | Page <u>3</u> of _____ for Vessel/Plant |
| 6/28/23 | 19999 | 5676 | 187 | | Page <u>3</u> of <u>3</u> for Haul/Offload |

| | | | | |
|---------------------------------|--------------------------------|---------------------------|---------------------------------------|---|
| Sample #: <u>2</u> | Sub-Sample #: <u>201</u> | Sample Size: <u>84.84</u> | <small>kg</small> Segments pots | # of Sampled Hooks: |
| Presorted <input type="radio"/> | Combined <input type="radio"/> | | | No Fish in Sample <input type="radio"/> |

| Species | Sex | # | Weight | % ret. | Length, viability, injury, specimen, tally data, measurements, bird observations, sample design, notes: |
|----------------------|-------------------------------------|-----------|--------------|-------------------------------------|---|
| ----- KEYPUNCH ----- | <input checked="" type="checkbox"/> | <u>73</u> | <u>84.84</u> | <input checked="" type="checkbox"/> | <u>Flowscale/MCP</u> |
| Pollock | | <u>57</u> | <u>39.34</u> | <u>100</u> | <u>Start: 53905</u> |
| P. Cod | | <u>13</u> | <u>43.06</u> | <u>100</u> | <u>End: 53990</u> |
| Jellyfish | | <u>2</u> | <u>.82</u> | <u>0</u> | <u>Pollock S/L</u> |
| Arrowtooth | | <u>1</u> | <u>1.62</u> | <u>0</u> | <u>M F</u> |
| | | | | | <u>(51)-L (42)-L</u> |
| | | | | | <u>50-1 39-1</u> |
| | | | | | <u>(41)-1 46-1</u> |
| | | | | | <u>40-1 49-1</u> |
| | | | | | <u>(45)-L 41-1</u> |
| | | | | | <u>48-1 45-1</u> |
| | | | | | <u>46-1 (38)-1</u> |
| | | | | | <u>(47)-L (43)-1</u> |
| | | | | | <u>(49)-1 (50)-1</u> |
| | | | | | <u>Pollock S/L/W</u> |
| | | | | | <u>Sp#1-M/51/.87</u> |
| | | | | | <u>2-M/41/.50</u> |
| | | | | | <u>3-M/45/.55</u> |
| | | | | | <u>4-M/47/.54</u> |
| | | | | | <u>5-M/47/.56</u> |
| | | | | | <u>6-F/42/.51</u> |
| | | | | | <u>7-F/38/.42</u> |
| | | | | | <u>8-F/50/.95</u> |
| | | | | | <u>Pollock Otoliths</u> |
| | | | | | <u>sp#9-M/49/.79</u> |
| | | | | | <u>427617</u> |
| | | | | | <u>sp#10-F/43/.60 spent</u> |
| | | | | | <u>427616</u> |

Subsample 201 contained both predominant species. However, if both predominant species were not present, additional subsamples would be collected until both predominant species were present. All additional subsamples must be recorded as discrete subsamples.

Tally K/P P.P.

| | | | | |
|---------------------------------|--------------------------------|------------------------------|---------------------------------------|---|
| Sample #: <u>3</u> | Sub-Sample #: | Sample Size: <u>15302.00</u> | <small>kg</small> Segments pots | # of Sampled Hooks: |
| Presorted <input type="radio"/> | Combined <input type="radio"/> | | | No Fish in Sample <input type="radio"/> |

| Species | Sex | # | Weight | % ret. | Length, viability, injury, specimen, tally data, measurements, bird observations, sample design, notes: |
|----------------------|-------------------------------------|------------|-----------------|-------------------------------------|---|
| ----- KEYPUNCH ----- | <input checked="" type="checkbox"/> | <u>111</u> | <u>15302.00</u> | <input checked="" type="checkbox"/> | <u>Start: 91006</u> |
| Pollock | | <u>0</u> | <u>15172.68</u> | <u>100</u> | <u>End: 106308</u> |
| P. Cod | | <u>9</u> | <u>31.55</u> | <u>100</u> | <u>Total Sample wt: 15302.00</u> |
| Flathead Sole | | <u>34</u> | <u>12.94</u> | <u>0</u> | <u>Bycatch wt: -56.32</u> |
| AK. Skate | | <u>1</u> | <u>6.70</u> | <u>0</u> | <u>Pollock Subset: -73.00</u> |
| Arrowtooth | | <u>2</u> | <u>3.00</u> | <u>0</u> | <u>wt. of uncounted pollock: 15172.68</u> |
| Herring | | <u>8</u> | <u>2.13</u> | <u>0</u> | <u>Salmon Retention Count H187 @ 13:06</u> |
| | | | | | <u>Sorter: James Hetfield</u> |
| | | | | | <u>Genetics start: Chinook RN=6 Chum RN=30</u> |
| | | | | | <u>Chum-(75) Chinook-(7) Coho-0</u> |
| | | | | | <u>Pink-0 Sockeye-0</u> |
| | | | | | <u>Genetics/FMAID</u> |
| | | | | | <u>sp#11-Chum, M/53/2.08/Adipose present</u> |
| | | | | | <u>All scales: Zone B</u> |
| | | | | | <u>sp#12-Chum, F/61/2.51/Adipose present</u> |
| | | | | | <u>All scales: Zone A</u> |
| | | | | | <u>sp#13-Chinook, F/71/3.91/Adipose present</u> |
| | | | | | <u>Genetics scales: Zone B FMAID-Zone C</u> |
| | | | | | <u>Genetics for next Haul:</u> |
| | | | | | <u>-Last Chinook-1 (next 9)</u> |
| | | | | | <u>-Last Chum-15 (next 15)</u> |

Expecting high Chum salmon numbers, the observer used a thumb counter to tally these species.

Tally K/P P.P.

Ver. 2016
GPO U.S. GOVERNMENT PRINTING OFFICE 2015-677-023

Figure 5-9: Example of Subsample Data for Two Predominant Species and Salmon Retention Count on a Pollock CP

1 in 5 Randomized Block Design - Sample Table #1

| | | | | | | | | | | | | | | | | | | | | | | | | | | |
|---|---|---|---|---|---|---|---|---|---|---|---|---|---|---|---|---|---|---|---|---|---|---|---|---|---|---|
| | A | B | C | D | E | F | G | H | I | J | K | L | M | N | O | P | Q | R | S | T | U | V | W | X | Y | Z |
| A | 4 | 1 | 2 | 1 | 4 | 1 | 1 | 2 | 1 | 2 | 3 | 4 | 4 | 3 | 3 | 3 | 1 | 2 | 3 | 3 | 4 | 3 | 3 | 4 | 4 | 4 |
| B | 5 | 3 | 2 | 3 | 4 | 2 | 3 | 4 | 3 | 1 | 4 | 1 | 2 | 3 | 3 | 3 | 1 | 2 | 5 | 1 | 1 | 2 | 5 | 4 | 2 | 3 |
| C | 4 | 2 | 3 | 1 | 1 | 4 | 3 | 4 | 1 | 5 | 3 | 2 | 1 | 3 | 3 | 2 | 1 | 2 | 5 | 4 | 4 | 2 | 2 | 2 | 2 | 4 |
| D | 4 | 4 | 1 | 3 | 1 | 4 | 3 | 5 | 3 | 5 | 4 | 2 | 4 | 4 | 4 | 2 | 2 | 3 | 2 | 1 | 2 | 4 | 2 | 1 | 1 | 3 |
| E | 3 | 5 | 3 | 3 | 3 | 2 | 3 | 2 | 3 | 3 | 3 | 4 | 5 | 2 | 1 | 3 | 1 | 5 | 2 | 2 | 3 | 1 | 4 | 5 | 3 | 1 |

Page _____ of _____ for Vessel

Page _____ of _____ for Haul

Halibut Deck Sort Data Form

| Date | Cruise | Permit | Haul No. | Time Codend Opened | Time Sorting Ended | Total Sorting Time (minutes) |
|------|--------|--------|----------|--------------------|--------------------|------------------------------|
| | | | | | | S.W. Calc. |

| | A | B | C | D | E |
|----|--------------------------|--------------------------|--------------------------|--------------------------|--------------------------|
| 1 | <input type="checkbox"/> | <input type="checkbox"/> | <input type="checkbox"/> | <input type="checkbox"/> | <input type="checkbox"/> |
| 2 | <input type="checkbox"/> | <input type="checkbox"/> | <input type="checkbox"/> | <input type="checkbox"/> | <input type="checkbox"/> |
| 3 | <input type="checkbox"/> | <input type="checkbox"/> | <input type="checkbox"/> | <input type="checkbox"/> | <input type="checkbox"/> |
| 4 | <input type="checkbox"/> | <input type="checkbox"/> | <input type="checkbox"/> | <input type="checkbox"/> | <input type="checkbox"/> |
| 5 | <input type="checkbox"/> | <input type="checkbox"/> | <input type="checkbox"/> | <input type="checkbox"/> | <input type="checkbox"/> |
| 6 | <input type="checkbox"/> | <input type="checkbox"/> | <input type="checkbox"/> | <input type="checkbox"/> | <input type="checkbox"/> |
| 7 | <input type="checkbox"/> | <input type="checkbox"/> | <input type="checkbox"/> | <input type="checkbox"/> | <input type="checkbox"/> |
| 8 | <input type="checkbox"/> | <input type="checkbox"/> | <input type="checkbox"/> | <input type="checkbox"/> | <input type="checkbox"/> |
| 9 | <input type="checkbox"/> | <input type="checkbox"/> | <input type="checkbox"/> | <input type="checkbox"/> | <input type="checkbox"/> |
| 10 | <input type="checkbox"/> | <input type="checkbox"/> | <input type="checkbox"/> | <input type="checkbox"/> | <input type="checkbox"/> |
| 11 | <input type="checkbox"/> | <input type="checkbox"/> | <input type="checkbox"/> | <input type="checkbox"/> | <input type="checkbox"/> |
| 12 | <input type="checkbox"/> | <input type="checkbox"/> | <input type="checkbox"/> | <input type="checkbox"/> | <input type="checkbox"/> |
| 13 | <input type="checkbox"/> | <input type="checkbox"/> | <input type="checkbox"/> | <input type="checkbox"/> | <input type="checkbox"/> |
| 14 | <input type="checkbox"/> | <input type="checkbox"/> | <input type="checkbox"/> | <input type="checkbox"/> | <input type="checkbox"/> |
| 15 | <input type="checkbox"/> | <input type="checkbox"/> | <input type="checkbox"/> | <input type="checkbox"/> | <input type="checkbox"/> |
| 16 | <input type="checkbox"/> | <input type="checkbox"/> | <input type="checkbox"/> | <input type="checkbox"/> | <input type="checkbox"/> |
| 17 | <input type="checkbox"/> | <input type="checkbox"/> | <input type="checkbox"/> | <input type="checkbox"/> | <input type="checkbox"/> |
| 18 | <input type="checkbox"/> | <input type="checkbox"/> | <input type="checkbox"/> | <input type="checkbox"/> | <input type="checkbox"/> |
| 19 | <input type="checkbox"/> | <input type="checkbox"/> | <input type="checkbox"/> | <input type="checkbox"/> | <input type="checkbox"/> |
| 20 | <input type="checkbox"/> | <input type="checkbox"/> | <input type="checkbox"/> | <input type="checkbox"/> | <input type="checkbox"/> |
| 21 | <input type="checkbox"/> | <input type="checkbox"/> | <input type="checkbox"/> | <input type="checkbox"/> | <input type="checkbox"/> |
| 22 | <input type="checkbox"/> | <input type="checkbox"/> | <input type="checkbox"/> | <input type="checkbox"/> | <input type="checkbox"/> |
| 23 | <input type="checkbox"/> | <input type="checkbox"/> | <input type="checkbox"/> | <input type="checkbox"/> | <input type="checkbox"/> |
| 24 | <input type="checkbox"/> | <input type="checkbox"/> | <input type="checkbox"/> | <input type="checkbox"/> | <input type="checkbox"/> |
| 25 | <input type="checkbox"/> | <input type="checkbox"/> | <input type="checkbox"/> | <input type="checkbox"/> | <input type="checkbox"/> |

| Sample #: 9000 | | Presorted <input checked="" type="checkbox"/> | | Sample Size: _____ Kgs | |
|-----------------------|--------------------------|---|--------|--------------------------|--|
| Species | Sex | # | Weight | % ret. | |
| ----- KEYPUNCH ----- | <input type="checkbox"/> | | | <input type="checkbox"/> | |
| | | | | | |

Figure 5-10: Setting up the Halibut Deck Sort Data Form using the 1 in 5 Random Block Design Table Example

Page 152 of 182 for Vessel
 Page 1 of 3 for Haul

SB

Halibut Deck Sort Data Form

| Date | Cruise | Permit | Haul No. | Time Codend Opened | Time Sorting Ended | Total Sorting Time (minutes) | S.W. Calc. |
|----------|--------|--------|----------|--------------------|--------------------|------------------------------|------------|
| 04/02/23 | 20778 | 1239 | 201 | 1841 | 1912 | 31 | |

| | A | B | C | D | E |
|----|--------|-------|--------|---|---|
| 1 | ✓ | ✓ | ✓ | ✓ | |
| 2 | ✓ | ✓ | 113, P | | |
| 3 | ✓ | ✓ | ✓ | | |
| 4 | 64, E | 63, E | ✓ | | |
| 5 | ✓ | ✓ | ✓ | | |
| 6 | ✓ | ✓ | 58, D | | |
| 7 | ✓ | ✓ | ✓ | | |
| 8 | ✓ | 67, P | ✓ | | |
| 9 | 93, P | ✓ | ✓ | | |
| 10 | ✓ | ✓ | ✓ | | |
| 11 | 56, E | ✓ | ✓ | | |
| 12 | ✓ | ✓ | ✓ | | |
| 13 | ✓ | ✓ | ✓ | | |
| 14 | ✓ | ✓ | ✓ | | |
| 15 | ✓ | 85, P | 78, P | | |
| 16 | 71, E | ✓ | 83, D | | |
| 17 | ✓ | ✓ | ✓ | | |
| 18 | ✓ | ✓ | ✓ | | |
| 19 | ✓ | ✓ | ✓ | | |
| 20 | ✓ | 62, P | ✓ | | |
| 21 | ✓ | 98, E | ✓ | | |
| 22 | ✓ | ✓ | ✓ | | |
| 23 | 104, P | ✓ | ✓ | | |
| 24 | ✓ | ✓ | 68, D | | |
| 25 | ✓ | ✓ | ✓ | | |

The sample size for the halibut deck sort sample is the Observer Estimate as it appears on the Observer Haul Form.

| Sample #: 9000 | | Presorted <input checked="" type="radio"/> | | Sample Size: 19124.00 Kgs | |
|-----------------------|-------------------------------------|--|--------------|-------------------------------------|--|
| Species | Sex | # | Weight | % ret. | |
| ----- KEYPUNCH ----- | <input checked="" type="checkbox"/> | 76 | 98.79 | <input checked="" type="checkbox"/> | |
| Halibut | | 15 | 98.79 | 0 | |
| Halibut | | 61 | 0 | 0 | |

Once you have entered the halibut deck sort data into ATLAS, you can update the assessed halibut weight generated in the Species Comp Data tab, sample 9000.

Figure 5-11: Example of Documenting Halibut Deck Sort Data on a Flatfish CP

TRAWLER COMPOSITION SAMPLING : TRAWL DECK FORM EXAMPLES

SB DECK FORM

Date: 04/02/23 Cruise: 20778 Permit: 1239 Haul No.: 201 Offload No.:
 Page 153 of 182 for Vessel/Plant
 Page 2 of 3 for Haul/Offload

Sample #: 1 Sub-Sample #: Sample Size: 210.67 ^{Kgs} Segments pots # of Sampled Hooks:
 Presorted Combined No Fish in Sample

| Species | Sex | # | Weight | % ret. |
|----------------------|-------------------------------------|-----|--------|-------------------------------------|
| ----- KEYPUNCH ----- | <input checked="" type="checkbox"/> | 215 | 210.67 | <input checked="" type="checkbox"/> |
| Pollock | | 26 | 46.30 | 20 |
| P. Cod | | 5 | 49.12 | 100 |
| AK Skate | | 8 | 44.52 | 0 |
| Flathead Sole | | 96 | 42.58 | 100 |
| Northern R.S. | | 22 | 9.83 | 100 |
| Yellowfin Sole | | 4 | 2.36 | 100 |
| Brittle Star | | 54 | 3.50 | 0 |
| Brittle Star | | 0 | 12.46 | 0 |

Length, viability, injury, specimen, tally data, measurements, bird observations, sample design, notes:
 Hail Wt = 18 MT = 18000 Kg / 200 Kg = 90 units
 90 units / 3 = 30 (interval) RN = 27 (0-29)
 S1 = 27 x 200 Kg ~ 5400 Kg
 S2 = 57 x 200 Kg ~ 11400 Kg - S/L, FS/MCP
 S3 = 87 x 200 Kg ~ 17400

There were too many brittle stars to count in this sample. The observer randomly collected ~50 individuals to weigh and count, and the rest were weighed only. These were entered on a separate line, with zero entered in the number field.

MCP test: 10@10.0, 25@25.0, 50@50.0

Sample #: 2 Sub-Sample #: Sample Size: 221.16 ^{Kgs} Segments pots # of Sampled Hooks:
 Presorted Combined No Fish in Sample

| Species | Sex | # | Weight | % ret. |
|----------------------|-------------------------------------|-----|--------|-------------------------------------|
| ----- KEYPUNCH ----- | <input checked="" type="checkbox"/> | 286 | 221.16 | <input checked="" type="checkbox"/> |
| P. Cod | | 10 | 46.84 | 100 |
| Pollock | | 31 | 47.90 | 20 |
| Flathead Sole | | 81 | 35.00 | 100 |
| AK Skate | | 10 | 20.17 | 0 |
| Northern R.S. | | 23 | 10.06 | 100 |
| Rocksole Un. | | 101 | 46.52 | 100 |
| Yellowfin Sole | | 30 | 14.67 | 100 |

Length, viability, injury, specimen, tally data, measurements, bird observations, sample design, notes:
 Flowscale/MCP Start: 11507 End: 11726
 Flathead Sole S/L

| M | F |
|------|------|
| 24-1 | 25-1 |
| 33-1 | 33-1 |
| 35-1 | 34-1 |
| 42-1 | 35-1 |
| | 36-1 |
| | 38-1 |
| | 40-1 |
| | 41-1 |

 Flathead oto's
 sp# 150-M, 42.82 4305441
 sp# 151-F, 36.36 4305486
 sp# 152-F, 38.58 4305410
 sp# 153-F, 35.52 4305402
 Northern R. Sole S/L

| M | F |
|------|------|
| 31-1 | 37-1 |
| 33-1 | 33-1 |

 N. Rock Sole oto's
 sp# 154-M, 31.29 4509113

A subset sample was taken from rock sole in the sample - these fish were reported to species. The rest of the rock sole were counted and weighed, but not identified to species. These were reported to the group level (as rock sole unidentified).

Tally K/P

Ver. 2016

Figure 5-12: Example of Documenting Data From Samples on a Flatfish CP

SB
DECK FORM

| | | | | | |
|----------|--------|--------|----------|-------------|--|
| Date | Cruise | Permit | Haul No. | Offload No. | Page <u>154</u> of <u>182</u> for Vessel/Plant |
| 04/02/23 | 20778 | 1239 | 201 | | Page <u>2</u> of <u>3</u> for Haul/Offload |

| | | | | |
|---------------------------------|--------------------------------|----------------------------|--|---|
| Sample #: <u>3</u> | Sub-Sample #: | Sample Size: <u>200.51</u> | <small>Kgs Segments pots</small> | # of Sampled Hooks: |
| Presorted <input type="radio"/> | Combined <input type="radio"/> | | | No Fish in Sample <input type="radio"/> |

| Species | Sex | # | Weight | % ret. | Length, viability, injury, specimen, tally data, measurements, bird observations, sample design, notes: | | | | | | | | | | | | | | |
|----------------------|------|-----|--------|--------|---|---|---|------|------|------|------|------|--|---|---|------|------|------|------|
| ----- KEYPUNCH ----- | X | 135 | 200.51 | X | <p style="margin: 0;">AK Skates S/L - From Sample 2</p> <table style="margin: 5px 0; border-collapse: collapse;"> <tr><td style="border-right: 1px solid black; padding: 2px;">F</td><td style="padding: 2px;">M</td></tr> <tr><td style="border-right: 1px solid black; padding: 2px;">67-1</td><td style="padding: 2px;">51-1</td></tr> <tr><td style="border-right: 1px solid black; padding: 2px;">72-1</td><td style="padding: 2px;">70-1</td></tr> <tr><td style="border-right: 1px solid black; padding: 2px;">68-1</td><td style="padding: 2px;"></td></tr> </table> <p style="margin: 5px 0;">Rougheye S/L</p> <table style="margin: 5px 0; border-collapse: collapse;"> <tr><td style="border-right: 1px solid black; padding: 2px;">M</td><td style="padding: 2px;">F</td></tr> <tr><td style="border-right: 1px solid black; padding: 2px;">57-1</td><td style="padding: 2px;">60-1</td></tr> <tr><td style="border-right: 1px solid black; padding: 2px;">65-1</td><td style="padding: 2px;">63-1</td></tr> </table> <p style="margin: 5px 0;">Rougheye oto's</p> <p style="margin: 5px 0;">sp#155-M, 57, 2.81 4620913</p> <p style="margin: 5px 0;">sp#156-M, 65, 3.25 4620481</p> <p style="margin: 5px 0;">sp#157-F, 63, 3.15 4620555</p> | F | M | 67-1 | 51-1 | 72-1 | 70-1 | 68-1 | | M | F | 57-1 | 60-1 | 65-1 | 63-1 |
| F | M | | | | | | | | | | | | | | | | | | |
| 67-1 | 51-1 | | | | | | | | | | | | | | | | | | |
| 72-1 | 70-1 | | | | | | | | | | | | | | | | | | |
| 68-1 | | | | | | | | | | | | | | | | | | | |
| M | F | | | | | | | | | | | | | | | | | | |
| 57-1 | 60-1 | | | | | | | | | | | | | | | | | | |
| 65-1 | 63-1 | | | | | | | | | | | | | | | | | | |
| Pollock | | 32 | 47.52 | 20 | | | | | | | | | | | | | | | |
| P. Cod | | 9 | 50.76 | 100 | | | | | | | | | | | | | | | |
| AK. Skate | | 6 | 27.11 | 0 | | | | | | | | | | | | | | | |
| Rex Sole | | 8 | 4.21 | 100 | | | | | | | | | | | | | | | |
| Northern R.S. | | 14 | 5.39 | 100 | | | | | | | | | | | | | | | |
| Halibut | | 21 | 22.96 | 0 | | | | | | | | | | | | | | | |
| Yellowfin Sole | | 3 | 1.43 | 100 | | | | | | | | | | | | | | | |
| Arrowtooth | | 2 | 3.82 | 0 | | | | | | | | | | | | | | | |
| Fish Waste | | 0 | 8.35 | 0 | | | | | | | | | | | | | | | |
| Rougheye Rf. | | 4 | 12.21 | 0 | | | | | | | | | | | | | | | |
| Flathead Sole | | 36 | 16.75 | 100 | | | | | | | | | | | | | | | |
| | | | | | | | | | | | | | | | | | | | |
| | | | | | | | | | | | | | | | | | | | |
| | | | | | | | | | | | | | | | | | | | |
| | | | | | | | | | | | | | | | | | | | |
| | | | | | | | | | | | | | | | | | | | |
| | | | | | | | | | | | | | | | | | | | |
| | | | | | | | | | | | | | | | | | | | |
| | | | | | | | | | | | | | | | | | | | |
| | | | | | | | | | | | | | | | | | | | |

| | | | | |
|---------------------------------|--------------------------------|--------------|--|---|
| Sample #: | Sub-Sample #: | Sample Size: | <small>Kgs Segments pots</small> | # of Sampled Hooks: |
| Presorted <input type="radio"/> | Combined <input type="radio"/> | | | No Fish in Sample <input type="radio"/> |

| Species | Sex | # | Weight | % ret. | Length, viability, injury, specimen, tally data, measurements, bird observations, sample design, notes: |
|----------------------|-----|---|--------|--------|--|
| ----- KEYPUNCH ----- | X | | | X | <p style="margin: 0;"><u>Halibut Lengths/Viabilities</u> (Haul Level)</p> <p style="margin: 5px 0;">48-D</p> <p style="margin: 5px 0;">51-D</p> <p style="margin: 5px 0;">36-D</p> <p style="margin: 5px 0;">65-P</p> <p style="margin: 5px 0;">50-D</p> <p style="margin: 5px 0;">45-D</p> <p style="margin: 5px 0;">45-D</p> <p style="margin: 5px 0;">53-D</p> <p style="margin: 5px 0;">42-D</p> |
| | | | | | |
| | | | | | |
| | | | | | |
| | | | | | |
| | | | | | |
| | | | | | |
| | | | | | |
| | | | | | |
| | | | | | |
| | | | | | |
| | | | | | |
| | | | | | |
| | | | | | |
| | | | | | |

Figure 5-13: Example of Documenting Data From Samples on a Flatfish CP

Halibut Deck Sort Data Form

| Date | Cruise | Permit | Haul No. | Time Codend Opened | Time Sorting Ended | Total Sorting Time (minutes) | S.W. Calc. |
|----------|--------|--------|----------|--------------------|--------------------|------------------------------|------------|
| 04/03/23 | 20778 | 1239 | 207 | 1345 | 1356 | 11 | |

| | A | B | C | D | E |
|----|----|---|---|---|---|
| 1 | 61 | | | | |
| 2 | 85 | | | | |
| 3 | 73 | | | | |
| 4 | | | | | |
| 5 | | | | | |
| 6 | | | | | |
| 7 | | | | | |
| 8 | | | | | |
| 9 | | | | | |
| 10 | | | | | |
| 11 | | | | | |
| 12 | | | | | |
| 13 | | | | | |
| 14 | | | | | |
| 15 | | | | | |
| 16 | | | | | |
| 17 | | | | | |
| 18 | | | | | |
| 19 | | | | | |
| 20 | | | | | |
| 21 | | | | | |
| 22 | | | | | |
| 23 | | | | | |
| 24 | | | | | |
| 25 | | | | | |

It was evident that there was a low abundance of halibut for this haul. All deck sorted halibut were measured and the first randomly selected assessment fish was not reached.

Sample #: **9000** Presorted Sample Size: **16587.00** Kgs

| Species | Sex | # | Weight | % ret. |
|----------------------|-------------------------------------|---|--------|-------------------------------------|
| ----- KEYPUNCH ----- | <input checked="" type="checkbox"/> | 3 | 14.57 | <input checked="" type="checkbox"/> |
| Halibut | | 3 | 14.57 | 0 |
| | | | | |
| | | | | |

First randomly selected assessment halibut was not reached but you were able to measure all the deck sorted halibut. Once you enter these data in ATLAS, you can update the unassessed halibut weight generated in the Species Comp Data tab, sample 9000.

Figure 5-14: Example of Documenting Low Halibut Abundance Deck Sort Data on a Flatfish CP

DECK FORM

| | | | | | |
|----------|--------|--------|----------|-------------|--|
| Date | Cruise | Permit | Haul No. | Offload No. | Page <u>22</u> of _____ for Vessel/Plant |
| 10/17/23 | 22834 | 5678 | 35 | | Page <u>1</u> of <u>2</u> for Haul/Offload |

| | | | | |
|---------------------------------|--------------------------------|----------------------------|--|---|
| Sample #: <u>1</u> | Sub-Sample #: | Sample Size: <u>115.00</u> | <small>Kgs</small> <small>Segments</small> <small>pots</small> | # of Sampled Hooks: |
| Presorted <input type="radio"/> | Combined <input type="radio"/> | | | No Fish in Sample <input type="radio"/> |

| Species | Sex | # | Weight | % ret. | Length, viability, injury, specimen, tally data, measurements, bird observations, sample design, notes: |
|----------------------|-------------------------------------|-------------------------------------|-------------------------------------|-------------------------------------|--|
| ----- KEYPUNCH ----- | <input checked="" type="checkbox"/> | <input checked="" type="checkbox"/> | <input checked="" type="checkbox"/> | <input checked="" type="checkbox"/> | |
| Pollock | | 89 | 115.00 | 100 | BOMT @ 35min $l = 267$ rate per 100kg unit = 0.04375min (NMFS RNT) sample 1 - 223 @ 9min 45sec sample 2 - 490 @ 21min 26sec sample ③ - 757 @ 33min 07sec 5/L <u>Chum FMA ID Scales</u> sp# 61 - M @ 58/2.70/Adipose present, Zone A sp# 62 - F @ 72/5.20/Adipose present, Zone A sp# 63 - F @ 63/3.10/Adipose present, Zone B/C |
| Pollock | | 29 | 31.80 | 100 | |
| Pollock | | 26 | 33.60 | 100 | |
| Pollock | | 30 | 34.40 | 100 | |
| P. Cod | | 1 | 4.20 | 100 | |
| Chum | F | 2 | 8.30 | 100 | |
| Chum | M | 1 | 2.70 | 100 | |

Any salmon encountered at sea must be placed in the RSW tanks for the offload salmon retention count and salmon retention data.

| | | | | |
|---------------------------------|--------------------------------|----------------------------|--|---|
| Sample #: <u>2</u> | Sub-Sample #: | Sample Size: <u>113.10</u> | <small>Kgs</small> <small>Segments</small> <small>pots</small> | # of Sampled Hooks: |
| Presorted <input type="radio"/> | Combined <input type="radio"/> | | | No Fish in Sample <input type="radio"/> |

| Species | Sex | # | Weight | % ret. | Length, viability, injury, specimen, tally data, measurements, bird observations, sample design, notes: |
|----------------------|-------------------------------------|-------------------------------------|-------------------------------------|-------------------------------------|--|
| ----- KEYPUNCH ----- | <input checked="" type="checkbox"/> | <input checked="" type="checkbox"/> | <input checked="" type="checkbox"/> | <input checked="" type="checkbox"/> | |
| Pollock | | 85 | 113.10 | 100 | <u>Chum FMA ID Scales</u> sp# 64 - M @ 71/3.6/Adipose present, Zone A sp# 65 - F @ 54/2.8/Adipose present, Zone A/B sp# 66 - F @ 68/3.0/Adipose present, Zone A sp# 67 - M @ 68/3.2/Adipose present, Zone C sp# 68 - F @ 71/3.8/Adipose absent, Zone B/C Snout collected |
| Pollock | | 36 | 43.20 | 100 | |
| Pollock | | 25 | 32.40 | 100 | |
| Pollock | | 16 | 17.60 | 100 | |
| Jelly fish | | 3 | 3.90 | 100 | |
| Chum | F | 3 | 9.60 | 100 | |
| Chum | M | 2 | 6.40 | 100 | |

Snout, sex/length/weight, and FMA ID scale specimens collected from the chum missing the adipose fin.

Tally K/P

Ver. 2016

Figure 5-15: Example of Documenting Data From a Bering Sea Pollock Catcher Vessel

TRAWLER COMPOSITION SAMPLING : TRAWL DECK FORM EXAMPLES

DECK FORM

| | | | | | |
|----------|--------|--------|----------|-------------|--|
| Date | Cruise | Permit | Haul No. | Offload No. | Page <u>23</u> of _____ for Vessel/Plant |
| 10/17/23 | 22834 | 5678 | 35 | | Page <u>2</u> of <u>2</u> for Haul/Offload |

| | | | | |
|---------------------------------|--------------------------------|----------------------------|--|---|
| Sample #: <u>3</u> | Sub-Sample #: | Sample Size: <u>103.80</u> | <small>Kgs Segments pots</small> | # of Sampled Hooks: |
| Presorted <input type="radio"/> | Combined <input type="radio"/> | | | No Fish in Sample <input type="radio"/> |

| Species | Sex | # | Weight | % ret. | |
|----------------------|-----|----|--------|--------|--|
| ----- KEYPUNCH ----- | X | 83 | 103.80 | X | Length, viability, injury, specimen, tally data, measurements, bird observations, sample design, notes: → collected a specimen for species verification |
| Pollock | | 27 | 28.40 | 100 | |
| Pollock | | 30 | 34.60 | 100 | |
| Pollock | | 21 | 25.20 | 100 | |
| P. Cod | | 1 | 5.30 | 100 | |
| Gorgonian | | 1 | 1.20 | 100 | |
| Arrowtooth | | 3 | 9.10 | 100 | |
| | | | | | |

| | | | | |
|---------------------------------|--------------------------------|--------------|--|---|
| Sample #: | Sub-Sample #: | Sample Size: | <small>Kgs Segments pots</small> | # of Sampled Hooks: |
| Presorted <input type="radio"/> | Combined <input type="radio"/> | | | No Fish in Sample <input type="radio"/> |

| Species | Sex | # | Weight | % ret. | | | | | | | | | | | | | | | | | | | |
|----------------------|------|---|--------|--------|---|---|---|------|------|------|------|------|------|------|------|------|------|------|------|------|------|------|------|
| ----- KEYPUNCH ----- | X | | | X | Length, viability, injury, specimen, tally data, measurements, bird observations, sample design, notes: Pollock S/L <table style="margin-left: auto; margin-right: auto; border-collapse: collapse;"> <tr> <td style="border-right: 1px solid black; padding: 2px 5px;">M</td> <td style="padding: 2px 5px;">F</td> </tr> <tr> <td style="border-right: 1px solid black; padding: 2px 5px;">42-1</td> <td style="padding: 2px 5px;">43-1</td> </tr> <tr> <td style="border-right: 1px solid black; padding: 2px 5px;">43-1</td> <td style="padding: 2px 5px;">45-1</td> </tr> <tr> <td style="border-right: 1px solid black; padding: 2px 5px;">44-1</td> <td style="padding: 2px 5px;">46-1</td> </tr> <tr> <td style="border-right: 1px solid black; padding: 2px 5px;">45-L</td> <td style="padding: 2px 5px;">47-1</td> </tr> <tr> <td style="border-right: 1px solid black; padding: 2px 5px;">46-L</td> <td style="padding: 2px 5px;">48-L</td> </tr> <tr> <td style="border-right: 1px solid black; padding: 2px 5px;">50-1</td> <td style="padding: 2px 5px;">52-1</td> </tr> <tr> <td style="border-right: 1px solid black; padding: 2px 5px;">51-L</td> <td style="padding: 2px 5px;">52-1</td> </tr> <tr> <td style="border-right: 1px solid black; padding: 2px 5px;">52-L</td> <td style="padding: 2px 5px;">54-L</td> </tr> </table> <p style="text-align: right; margin-top: 10px;">(Sample 3)</p> | M | F | 42-1 | 43-1 | 43-1 | 45-1 | 44-1 | 46-1 | 45-L | 47-1 | 46-L | 48-L | 50-1 | 52-1 | 51-L | 52-1 | 52-L | 54-L |
| M | F | | | | | | | | | | | | | | | | | | | | | | |
| 42-1 | 43-1 | | | | | | | | | | | | | | | | | | | | | | |
| 43-1 | 45-1 | | | | | | | | | | | | | | | | | | | | | | |
| 44-1 | 46-1 | | | | | | | | | | | | | | | | | | | | | | |
| 45-L | 47-1 | | | | | | | | | | | | | | | | | | | | | | |
| 46-L | 48-L | | | | | | | | | | | | | | | | | | | | | | |
| 50-1 | 52-1 | | | | | | | | | | | | | | | | | | | | | | |
| 51-L | 52-1 | | | | | | | | | | | | | | | | | | | | | | |
| 52-L | 54-L | | | | | | | | | | | | | | | | | | | | | | |
| | | | | | | | | | | | | | | | | | | | | | | | |
| | | | | | | | | | | | | | | | | | | | | | | | |
| | | | | | | | | | | | | | | | | | | | | | | | |
| | | | | | | | | | | | | | | | | | | | | | | | |
| | | | | | | | | | | | | | | | | | | | | | | | |
| | | | | | | | | | | | | | | | | | | | | | | | |
| | | | | | | | | | | | | | | | | | | | | | | | |
| | | | | | | | | | | | | | | | | | | | | | | | |
| | | | | | | | | | | | | | | | | | | | | | | | |
| | | | | | | | | | | | | | | | | | | | | | | | |
| | | | | | | | | | | | | | | | | | | | | | | | |

Figure 5-16: Example of Documenting Data From a Bering Sea Pollock Catcher Vessel

| DECK FORM | | | | | Page <u>5</u> of _____ for Vessel/Plant | | | | | | |
|---------------------------------|-------------------------------------|----------------------------|----------------------------------|-------------------------------------|--|---|---|-------|-------|------|-------|
| Date | Cruise | Permit | Haul No. | Offload No. | Page <u>1</u> of <u>2</u> for Haul/Offload | | | | | | |
| 09/18/23 | 24680 | 7691 | 99 | | | | | | | | |
| Sample #: <u>1</u> | Sub-Sample #: | Sample Size: <u>187.20</u> | <small>Kgs Segments pots</small> | # of Sampled Hooks: | | | | | | | |
| Presorted <input type="radio"/> | Combined <input type="radio"/> | | | | No Fish in Sample <input type="radio"/> | | | | | | |
| Species | Sex | # | Weight | % ret. | Length, viability, injury, specimen, tally data, measurements, bird observations, sample design, notes: | | | | | | |
| ----- KEYPUNCH ----- | <input checked="" type="checkbox"/> | <u>34</u> | <u>187.20</u> | <input checked="" type="checkbox"/> | <p><u>Codend Volume</u></p> <p><u>Section 1</u> - </p> <p><u>Section 2</u> - </p> <p><u>AK skate S/L</u></p> <table style="margin-left: 20px;"> <tr><td>M</td><td>F</td></tr> <tr><td>104-1</td><td>97-1</td></tr> </table> | M | F | 104-1 | 97-1 | | |
| M | F | | | | | | | | | | |
| 104-1 | 97-1 | | | | | | | | | | |
| PCod | | <u>3</u> | <u>17.20</u> | <u>100</u> | | | | | | | |
| PCod | | <u>8</u> | <u>42.40</u> | <u>100</u> | | | | | | | |
| PCod | | <u>7</u> | <u>44.00</u> | <u>100</u> | | | | | | | |
| PCod | | <u>8</u> | <u>39.80</u> | <u>100</u> | | | | | | | |
| PCod | | <u>4</u> | <u>23.60</u> | <u>100</u> | | | | | | | |
| Halibut | | <u>2</u> | <u>4.20</u> | <u>0</u> | | | | | | | |
| Alaska Skate | | <u>2</u> | <u>16.00</u> | <u>100</u> | | | | | | | |
| Sample #: <u>2</u> | Sub-Sample #: | Sample Size: <u>194.05</u> | <small>Kgs Segments pots</small> | # of Sampled Hooks: | | | | | | | |
| Presorted <input type="radio"/> | Combined <input type="radio"/> | | | | No Fish in Sample <input type="radio"/> | | | | | | |
| Species | Sex | # | Weight | % ret. | Length, viability, injury, specimen, tally data, measurements, bird observations, sample design, notes: | | | | | | |
| ----- KEYPUNCH ----- | <input checked="" type="checkbox"/> | <u>34</u> | <u>194.05</u> | <input checked="" type="checkbox"/> | <p><u>15MT @ 60min i=33 RN=7</u></p> <p><u>rate per 150Kq unit=0.600</u></p> <p><u>S1=7@4min 12sec</u></p> <p><u>S2=40@24min</u></p> <p><u>S3=73@43min 48sec S/L</u></p> <p><u>Density Baskets (Red Baskets)</u></p> <p><u>B1=32.06 From Sample 1</u></p> <p><u>B2=31.85</u></p> <p><u>B3=33.20</u></p> <p><u>B4=31.45</u></p> <p><u>AK Skates S/L</u></p> <table style="margin-left: 20px;"> <tr><td>M</td><td>F</td></tr> <tr><td>98-1</td><td>101-1</td></tr> <tr><td>99-1</td><td>105-1</td></tr> </table> | M | F | 98-1 | 101-1 | 99-1 | 105-1 |
| M | F | | | | | | | | | | |
| 98-1 | 101-1 | | | | | | | | | | |
| 99-1 | 105-1 | | | | | | | | | | |
| P. Cod | | <u>5</u> | <u>40.80</u> | <u>100</u> | | | | | | | |
| P. Cod | | <u>8</u> | <u>42.00</u> | <u>100</u> | | | | | | | |
| P. Cod | | <u>8</u> | <u>44.80</u> | <u>100</u> | | | | | | | |
| P. Cod | | <u>5</u> | <u>28.00</u> | <u>100</u> | | | | | | | |
| Halibut | | <u>3</u> | <u>4.80</u> | <u>0</u> | | | | | | | |
| Rex Sole | | <u>1</u> | <u>.85</u> | <u>0</u> | | | | | | | |
| Alaska Skate | | <u>4</u> | <u>32.80</u> | <u>100</u> | | | | | | | |

Figure 5-17: Example of Documenting Data From a Bering Sea Pacific Cod Catcher Vessel

TRAWLER COMPOSITION SAMPLING : TRAWL DECK FORM EXAMPLES

DECK FORM

| | | | | | |
|----------|--------|--------|----------|-------------|--|
| Date | Cruise | Permit | Haul No. | Offload No. | Page <u>6</u> of _____ for Vessel/Plant |
| 09/18/23 | 24680 | 7691 | 99 | | Page <u>2</u> of <u>2</u> for Haul/Offload |

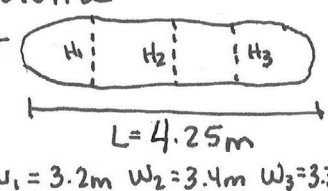
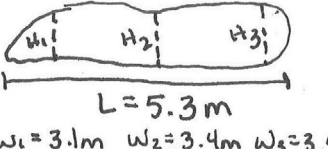
| | | | | |
|---------------------------------|--------------------------------|----------------------------|--|---|
| Sample #: <u>3</u> | Sub-Sample #: | Sample Size: <u>131.20</u> | <small>Kgs Segments pots</small> | # of Sampled Hooks: |
| Presorted <input type="radio"/> | Combined <input type="radio"/> | | | No Fish in Sample <input type="radio"/> |

| Species | Sex | # | Weight | % ret. | |
|----------------------|-----|----|--------|--------|---|
| ----- KEYPUNCH ----- | X | 29 | 131.20 | X | Length, viability, injury, specimen, tally data, measurements, bird observations, sample design, notes: PCod S/L M F 63-1 69-L 71-1 70-1 78-L 73-1 79-L 76-1 84-1 79-L 86-1 81-1 87-1 84-L 91-1 85-1 93-1 98-1 |
| PCod | | 7 | 36.80 | 100 | |
| P.Cod | | 7 | 36.40 | 100 | |
| P.Cod | | 10 | 44.40 | 100 | |
| Halibut | | 1 | 2.40 | 0 | |
| Great Sculpin | | 2 | 9.60 | 0 | |
| Pollock | | 1 | 1.00 | 100 | |
| Butter Sole | | 1 | .60 | 0 | |
| | | | | | |
| | | | | | |

| | | | | |
|---------------------------------|--------------------------------|--------------|--|---|
| Sample #: | Sub-Sample #: | Sample Size: | <small>Kgs Segments pots</small> | # of Sampled Hooks: |
| Presorted <input type="radio"/> | Combined <input type="radio"/> | | | No Fish in Sample <input type="radio"/> |

| Species | Sex | # | Weight | % ret. | |
|----------------------|-----|---|--------|--------|---|
| ----- KEYPUNCH ----- | X | | | X | Length, viability, injury, specimen, tally data, measurements, bird observations, sample design, notes: <u>Halibut Viabilities</u> (Haul level) 54-P 56-P 45-P 70-E 56-E 67-E 72-E 70-P |
| | | | | | |
| | | | | | |
| | | | | | |
| | | | | | |
| | | | | | |
| | | | | | |
| | | | | | |
| | | | | | |
| | | | | | |

Tally K/P

Ver. 2016

Figure 5-18: Example of Documenting Data From a Bering Sea Pacific Cod Catcher Trawler.

DECK FORM

| | | | | | |
|----------|--------|--------|----------|-------------|---|
| Date | Cruise | Permit | Haul No. | Offload No. | Page <u>1</u> of <u> </u> for Vessel/Plant |
| 07/13/23 | 20670 | 2345 | 165 | | Page <u>1</u> of <u>2</u> for Haul/Offload |

| | | | | |
|---------------------------------|---|----------------------------|-------------------------|---|
| Sample #: <u>1</u> | Sub-Sample #: <u> </u> | Sample Size: <u>350.85</u> | Kgs Segments pots | # of Sampled Hooks: <u> </u> |
| Presorted <input type="radio"/> | Combined <input checked="" type="radio"/> | | | No Fish in Sample <input type="radio"/> |

| Species | Sex | # | Weight | % ret. | Length, viability, injury, specimen, tally data, measurements, bird observations, sample design, notes: | | | | | | | | | | | | | | | | | | | | | | | | | | |
|---------------------------------|--|------------|---------------|-------------------------------------|---|-------------|--|---|---|------|--|----------|---------------------------------|------|------|------|------------------------------|------|----------|---------------------------------|------|----------|------|------|------|----------|------|------|--|------|--|
| ----- KEYPUNCH ----- | <input checked="" type="checkbox"/> | <u>322</u> | <u>350.85</u> | <input checked="" type="checkbox"/> | | | | | | | | | | | | | | | | | | | | | | | | | | | |
| Pollock | | <u>35</u> | <u>43.80</u> | <u>100</u> | <table border="1" style="width: 100%; border-collapse: collapse;"> <tr> <th colspan="2">Pollock S/L</th> </tr> <tr> <th>M</th> <th>F</th> </tr> <tr> <td>44-1</td> <td>(53) - <input checked="" type="checkbox"/></td> </tr> <tr> <td>(47) - L</td> <td>(54) - <input type="checkbox"/></td> </tr> <tr> <td>48-L</td> <td>56-L</td> </tr> <tr> <td>49-L</td> <td>59-<input type="checkbox"/></td> </tr> <tr> <td>51-L</td> <td>(60) - L</td> </tr> <tr> <td>(52) - <input type="checkbox"/></td> <td>61-L</td> </tr> <tr> <td>(53) - 1</td> <td>63-L</td> </tr> <tr> <td>55-L</td> <td>66-1</td> </tr> <tr> <td>(59) - 1</td> <td>67-1</td> </tr> <tr> <td>63-1</td> <td></td> </tr> <tr> <td>64-1</td> <td></td> </tr> </table> <p style="margin-top: 10px;"><u>Pollock Otoliths</u></p> <p>sp#1- M/53/1.60-393070</p> <p>#2- M/47/95-393073</p> <p>#3- F/60/1.90-393078 (Pre-spawn)</p> <p>#4- M/59/1.75-393071</p> <p>#5- F/53/1.30-393077 (Pre-spawn)</p> <p>#6- F/54/1.55-393072 (Pre-spawn)</p> <p>#7- M/52/1.25-393080</p> <p>#8- M/52/1.30-393076</p> | Pollock S/L | | M | F | 44-1 | (53) - <input checked="" type="checkbox"/> | (47) - L | (54) - <input type="checkbox"/> | 48-L | 56-L | 49-L | 59- <input type="checkbox"/> | 51-L | (60) - L | (52) - <input type="checkbox"/> | 61-L | (53) - 1 | 63-L | 55-L | 66-1 | (59) - 1 | 67-1 | 63-1 | | 64-1 | |
| Pollock S/L | | | | | | | | | | | | | | | | | | | | | | | | | | | | | | | |
| M | F | | | | | | | | | | | | | | | | | | | | | | | | | | | | | | |
| 44-1 | (53) - <input checked="" type="checkbox"/> | | | | | | | | | | | | | | | | | | | | | | | | | | | | | | |
| (47) - L | (54) - <input type="checkbox"/> | | | | | | | | | | | | | | | | | | | | | | | | | | | | | | |
| 48-L | 56-L | | | | | | | | | | | | | | | | | | | | | | | | | | | | | | |
| 49-L | 59- <input type="checkbox"/> | | | | | | | | | | | | | | | | | | | | | | | | | | | | | | |
| 51-L | (60) - L | | | | | | | | | | | | | | | | | | | | | | | | | | | | | | |
| (52) - <input type="checkbox"/> | 61-L | | | | | | | | | | | | | | | | | | | | | | | | | | | | | | |
| (53) - 1 | 63-L | | | | | | | | | | | | | | | | | | | | | | | | | | | | | | |
| 55-L | 66-1 | | | | | | | | | | | | | | | | | | | | | | | | | | | | | | |
| (59) - 1 | 67-1 | | | | | | | | | | | | | | | | | | | | | | | | | | | | | | |
| 63-1 | | | | | | | | | | | | | | | | | | | | | | | | | | | | | | | |
| 64-1 | | | | | | | | | | | | | | | | | | | | | | | | | | | | | | | |
| Pollock | | <u>18</u> | <u>21.80</u> | <u>100</u> | | | | | | | | | | | | | | | | | | | | | | | | | | | |
| Pollock | | <u>30</u> | <u>40.20</u> | <u>100</u> | | | | | | | | | | | | | | | | | | | | | | | | | | | |
| Pollock | | <u>25</u> | <u>31.60</u> | <u>100</u> | | | | | | | | | | | | | | | | | | | | | | | | | | | |
| P. Cod | | <u>2</u> | <u>19.80</u> | <u>100</u> | | | | | | | | | | | | | | | | | | | | | | | | | | | |
| Flathead Sole | | <u>21</u> | <u>5.20</u> | <u>100</u> | | | | | | | | | | | | | | | | | | | | | | | | | | | |
| Rex Sole | | <u>3</u> | <u>2.10</u> | <u>100</u> | | | | | | | | | | | | | | | | | | | | | | | | | | | |
| N. Rock Sole | | <u>3</u> | <u>2.20</u> | <u>100</u> | | | | | | | | | | | | | | | | | | | | | | | | | | | |

All measured fish, including those with specimen data, must be documented together. You must circle the lengths corresponding to fish that contributed specimen data.

| | | | | |
|---------------------------------|--------------------------------|--------------------------|-------------------------|---|
| Sample #: <u>2</u> | Sub-Sample #: <u> </u> | Sample Size: <u> </u> | Kgs Segments pots | # of Sampled Hooks: <u> </u> |
| Presorted <input type="radio"/> | Combined <input type="radio"/> | | | No Fish in Sample <input type="radio"/> |

| Species | Sex | # | Weight | % ret. | Length, viability, injury, specimen, tally data, measurements, bird observations, sample design, notes: | | | | | | | | | | | | | | | | | | | | |
|----------------------|-------------------------------------|-----------|--------------|-------------------------------------|--|------------|--|---|---|----------|----------|--|----------|------------|--|---|---|-------|--------------|-------|-----------|-------|---------------|--|------------|
| ----- KEYPUNCH ----- | <input checked="" type="checkbox"/> | | | <input checked="" type="checkbox"/> | | | | | | | | | | | | | | | | | | | | | |
| Pollock | | <u>36</u> | <u>43.60</u> | <u>100</u> | <p>*found 3 Flathead on deck next to where s1 & s2 were stored. Not sure which sample they belong to so I combined them</p> <table border="1" style="width: 100%; border-collapse: collapse;"> <tr> <th colspan="2">P. Cod S/L</th> </tr> <tr> <th>M</th> <th>F</th> </tr> <tr> <td>(77) - 1</td> <td>(89) - 1</td> </tr> <tr> <td></td> <td>(96) - 1</td> </tr> </table> <p style="margin-top: 10px;"><u>P Cod Otoliths</u></p> <p>sp#9- F/89/9.40/393074 (spawning)</p> <table border="1" style="width: 100%; border-collapse: collapse;"> <tr> <th colspan="2">Bairdi S/L</th> </tr> <tr> <th>M</th> <th>F</th> </tr> <tr> <td>103-L</td> <td>93-L no eggs</td> </tr> <tr> <td>108-1</td> <td>93-1 eggs</td> </tr> <tr> <td>123-L</td> <td>103-1 no eggs</td> </tr> <tr> <td></td> <td>108-L eggs</td> </tr> </table> | P. Cod S/L | | M | F | (77) - 1 | (89) - 1 | | (96) - 1 | Bairdi S/L | | M | F | 103-L | 93-L no eggs | 108-1 | 93-1 eggs | 123-L | 103-1 no eggs | | 108-L eggs |
| P. Cod S/L | | | | | | | | | | | | | | | | | | | | | | | | | |
| M | F | | | | | | | | | | | | | | | | | | | | | | | | |
| (77) - 1 | (89) - 1 | | | | | | | | | | | | | | | | | | | | | | | | |
| | (96) - 1 | | | | | | | | | | | | | | | | | | | | | | | | |
| Bairdi S/L | | | | | | | | | | | | | | | | | | | | | | | | | |
| M | F | | | | | | | | | | | | | | | | | | | | | | | | |
| 103-L | 93-L no eggs | | | | | | | | | | | | | | | | | | | | | | | | |
| 108-1 | 93-1 eggs | | | | | | | | | | | | | | | | | | | | | | | | |
| 123-L | 103-1 no eggs | | | | | | | | | | | | | | | | | | | | | | | | |
| | 108-L eggs | | | | | | | | | | | | | | | | | | | | | | | | |
| Pollock | | <u>37</u> | <u>44.20</u> | <u>100</u> | | | | | | | | | | | | | | | | | | | | | |
| Pollock | | <u>30</u> | <u>35.60</u> | <u>100</u> | | | | | | | | | | | | | | | | | | | | | |
| Pollock | | <u>30</u> | <u>37.40</u> | <u>100</u> | | | | | | | | | | | | | | | | | | | | | |
| P. Cod | | <u>1</u> | <u>7.80</u> | <u>100</u> | | | | | | | | | | | | | | | | | | | | | |
| Poacher U. | | <u>1</u> | <u>.05</u> | <u>100</u> | | | | | | | | | | | | | | | | | | | | | |
| Flathead Sole | | <u>24</u> | <u>5.30</u> | <u>100</u> | | | | | | | | | | | | | | | | | | | | | |
| Rex Sole | | <u>2</u> | <u>1.15</u> | <u>100</u> | | | | | | | | | | | | | | | | | | | | | |
| Arrowtooth | | <u>11</u> | <u>3.75</u> | <u>100</u> | | | | | | | | | | | | | | | | | | | | | |
| AK. skate | | <u>1</u> | <u>1.80</u> | <u>100</u> | | | | | | | | | | | | | | | | | | | | | |
| Bairdi | M | <u>6</u> | <u>2.20</u> | <u>100</u> | | | | | | | | | | | | | | | | | | | | | |
| Bairdi | F | <u>6</u> | <u>1.30</u> | <u>100</u> | | | | | | | | | | | | | | | | | | | | | |

Figure 5-19: Example of Combined Sample Data From a Pollock Catcher Trawler In the GOA.

TRAWLER COMPOSITION SAMPLING : TRAWL DECK FORM EXAMPLES

| DECK FORM | | | | | Page <u>2</u> of _____ for Vessel/Plant | |
|---------------------------------|-------------------------------------|--------------------------------|---------------|-------------------------------------|---|---|
| Date | Cruise | Permit | Haul No. | Offload No. | Page <u>2</u> of <u>2</u> for Haul/Offload | |
| 07/13/23 | 20670 | 2345 | 165 | | | |
| Sample #: <u>3</u> | | Sub-Sample #: | | Sample Size: <u>135.60</u> | <u>0</u> Kgs Segments pots | # of Sampled Hooks: |
| Presorted <input type="radio"/> | | Combined <input type="radio"/> | | | | No Fish in Sample <input type="radio"/> |
| Species | Sex | # | Weight | % ret. | Length, viability, injury, specimen, tally data, measurements, bird observations, sample design, notes: <u>Chinook Genetics</u> sp# 10- F/69/4.1/Adipose present/ Zone A sp# 11- F/52/2.3/Adipose present/ Zone A <u>Bairdi S/L</u> <u>M F</u> 88-1 73-1 eggs | |
| ----- KEYPUNCH ----- | <input checked="" type="checkbox"/> | <u>119</u> | <u>135.60</u> | <input checked="" type="checkbox"/> | | |
| Pollock | | <u>30</u> | <u>36.60</u> | <u>100</u> | | |
| Pollock | | <u>20</u> | <u>23.80</u> | <u>100</u> | | |
| Pollock | | <u>30</u> | <u>35.80</u> | <u>100</u> | | |
| Pollock | | <u>21</u> | <u>24.80</u> | <u>100</u> | | |
| Flathead Sole | | <u>7</u> | <u>3.00</u> | <u>100</u> | | |
| N. Rock Sole | | <u>2</u> | <u>.75</u> | <u>100</u> | | |
| Arrowtooth | | <u>4</u> | <u>1.05</u> | <u>100</u> | | |
| Chinook | <u>F</u> | <u>2</u> | <u>6.40</u> | <u>100</u> | | |
| Halibut | | <u>1</u> | <u>3.00</u> | <u>100</u> | | |
| Bairdi | <u>M</u> | <u>1</u> | <u>.25</u> | <u>100</u> | | |
| Bairdi | <u>F</u> | <u>1</u> | <u>.15</u> | <u>100</u> | | |
| | | | | | Tally K/P | |
| Sample #: | | Sub-Sample #: | | Sample Size: | <u>0</u> Kgs Segments pots | # of Sampled Hooks: |
| Presorted <input type="radio"/> | | Combined <input type="radio"/> | | | | No Fish in Sample <input type="radio"/> |
| Species | Sex | # | Weight | % ret. | Length, viability, injury, specimen, tally data, measurements, bird observations, sample design, notes: * FMA ID - take Chinook 4 take Chum 3 | |
| ----- KEYPUNCH ----- | <input checked="" type="checkbox"/> | | | <input checked="" type="checkbox"/> | | |
| | | | | | | |
| | | | | | | |
| | | | | | | |
| | | | | | | |
| | | | | | | |
| | | | | | | |
| | | | | | | |
| | | | | | | |
| | | | | | | |
| | | | | | | |
| | | | | | | |
| | | | | | Tally K/P | |

Figure 5-20: Example of GOA Pollock Catcher Trawler Sample Data

DECK FORM

| | | | | | |
|----------|--------|--------|----------|-------------|--|
| Date | Cruise | Permit | Haul No. | Offload No. | Page <u>3</u> of _____ for Vessel/Plant |
| 07/15/23 | 20670 | 2345 | | 1 | Page <u>1</u> of <u>1</u> for Haul/Offload |

| | | | | |
|---------------------------------|--------------------------------|--------------|-------------------------|---|
| Sample #: | Sub-Sample #: | Sample Size: | Kgs Segments pots | # of Sampled Hooks: |
| Presorted <input type="radio"/> | Combined <input type="radio"/> | | | No Fish in Sample <input type="radio"/> |

| Species | Sex | # | Weight | % ret. | |
|--------------------------|-----|---|--------------------------|--------|---|
| ----- KEYPUNCH ----- | X | | | X | <p>Length, viability, injury, specimen, tally data, measurements, bird observations, sample design, notes:</p> <p><u>Salmon Retention Count</u> (includes 2 chinook from @sea samples H165, sample 3) Chinook - <input checked="" type="checkbox"/> L (8) Chum - L (2) Colho - 1 (1) Sockeye - 0 Pink - 0</p> <p>* FMA ID - Take Chinook - 2 Take Chum - 3</p> |
| <u>Chinook Genetics:</u> | | | | | |
| sp#12 - M/56/3.00 | | | Adipose present / Zone A | | |
| sp#13 - M/42/2.80 | | | Adipose present / Zone A | | |
| FMA ID Fish - Zone A | | | | | |
| sp#14 - M/63/3.20 | | | Adipose present / Zone C | | |
| sp#15 - F/60/3.00 | | | Adipose present / Zone A | | |
| sp#16 - F/51/2.60 | | | Adipose present / Zone A | | |
| sp#17 - M/58/3.80 | | | Adipose present / Zone B | | |
| <u>Chum Genetics</u> | | | | | |
| sp#18 - M/61/3.90 | | | Adipose Present / Zone A | | |
| sp#19 - M/58/3.80 | | | Adipose Present / Zone C | | |

| | | | | |
|---------------------------------|--------------------------------|--------------|-------------------------|------------------------|
| Sample #: | Sub-Sample #: | Sample Size: | Kgs Segments pots | # of Sampled Hooks: |
| Presorted <input type="radio"/> | Combined <input type="radio"/> | | | |

| Species | Sex | # | Weight | % ret. | |
|----------------------|-----|---|--------------------------|--------|--|
| ----- KEYPUNCH ----- | X | | | X | <p>The two female Chinook encountered in haul 165 sample 3 were placed in the RSW tank and were tallied in the final offload Salmon Retention Count. Genetics from these two Chinook were recorded in the at-sea composition and specimen data at the sample level (Figure 5-20).</p> <p>FMD ID for next haul /offload: - Last Chinook - 4 (next 16) - Last Chum: 2 (next 1)</p> |
| <u>Colho FMA ID</u> | | | | | |
| sp#20 - M/55/3.60 | | | Adipose Present / Zone B | | |

National Marine Fisheries Service/Fisheries Monitoring and Analysis Division Ver. 2016

Figure 5-21: Example of a GOA Pollock Catcher Vessel Offload Salmon Retention Count

TRAWLER COMPOSITION SAMPLING : TRAWL DECK FORM EXAMPLES

DECK FORM

| | | | | | |
|---------|--------|--------|----------|-------------|--|
| Date | Cruise | Permit | Haul No. | Offload No. | Page <u>10</u> of <u>10</u> for Vessel/Plant |
| 7/20/23 | 20670 | 2345 | | 2 | Page <u>1</u> of <u>1</u> for Haul/Offload |

| | | | | | |
|---------------------------------|--------------------------------|--------------|-------------------------|------------------------|---|
| Sample #: | Sub-Sample #: | Sample Size: | Kgs Segments pots | # of Sampled Hooks: | |
| Presorted <input type="radio"/> | Combined <input type="radio"/> | | | | No Fish in Sample <input type="radio"/> |

| Species | Sex | # | Weight | % ret. | Length, viability, injury, specimen, tally data, measurements, bird observations, sample design, notes: |
|--------------------|-----|---|--------|--------|--|
| -----KEYPUNCH----- | X | | | X | <p style="text-align: center;"><u>Salmon Retention #</u></p> <p>Chinook - 0</p> <p>Chum - 0</p> <p>Coho - 0</p> <p>Sockeye - 0</p> <p>Pink - 0</p> |
| | | | | | |
| | | | | | |
| | | | | | |
| | | | | | |
| | | | | | |
| | | | | | |
| | | | | | |
| | | | | | |
| | | | | | |

Follow this format when you do not find any salmon species in your offload salmon retention count! It is important that raw data are represented on the Offload Deck Form. Enter this data on the Salmon Retention Form immediately following the offload.

| | | | | | |
|---------------------------------|--------------------------------|--------------|-------------------------|------------------------|---|
| Sample #: | Sub-Sample #: | Sample Size: | Kgs Segments pots | # of Sampled Hooks: | |
| Presorted <input type="radio"/> | Combined <input type="radio"/> | | | | No Fish in Sample <input type="radio"/> |

| Species | Sex | # | Weight | % ret. | Length, viability, injury, specimen, tally data, measurements, bird observations, sample design, notes: |
|--------------------|-----|---|--------|--------|---|
| -----KEYPUNCH----- | X | | | X | <p>offload Start: 1200</p> <p>No Breaks !!</p> <p>Finish : 1530</p> <p style="font-size: 2em; text-align: center;">NO SALMON IN OFFLOAD</p> |
| | | | | | |
| | | | | | |
| | | | | | |
| | | | | | |
| | | | | | |
| | | | | | |
| | | | | | |
| | | | | | |
| | | | | | |

National Marine Fisheries Service/Fisheries Monitoring and Analysis Division Ver. 2016

Figure 5-22: Example of GOA Pollock Offload With No Salmon Bycatch



MOTHERSHIP DATA COLLECTION

Table of Contents

| | |
|---|-----|
| Priorities | 6-1 |
| Introduction | 6-1 |
| Catch Information | 6-1 |
| Vessel Type | 6-2 |
| Haul Order for Motherships | 6-2 |
| Haul Order for CP/Motherships | 6-2 |
| Monitoring for Marine Mammals | 6-2 |
| Seabird Interactions and Sightings | 6-3 |
| Flow Scale - MCP Scale Weight Comparison Form and Flow Scale Test | 6-3 |
| Observer Estimates | 6-3 |
| Codend Delivery Duties | 6-3 |
| Pumped Fish Delivery Duties | 6-3 |
| Salmon Retention Data | 6-3 |
| Recording VHF and OHF Data | 6-3 |

PRIORITIES

- Your safety!
- Collect data and specimens from marine mammal and endangered seabird mortalities.
- Rehabilitate endangered and threatened seabirds.
- Collect salmon retention data.
- Verify and record fishing effort information for delivering catcher boats and for your vessel if operating as a CP.
- Send data to the Observer Program as directed (see “Sending Data” on page 2-39).
- Sample for species composition.
- Monitor for marine mammals.
- Document any compliance concerns.
- Measure and assess viabilities of Pacific Halibut.
- Measure and sex other prohibited species.
- Collect biological data from the appropriate species.
- Collect sexed length frequencies from the appropriate species.
- Complete research projects.
- Record all sightings of banded or tagged seabirds

- Record marine mammal sightings.

INTRODUCTION

A mothership is a factory vessel which routinely takes unsorted catch from other vessels. Unsorted catch is usually delivered by codend transfer but may be transferred by brailer, pumping, or another method. Some catcher/processors will act as motherships occasionally, intermittently taking catch from smaller delivering catcher boats while fishing for themselves.



CATCH INFORMATION

As an observer on a mothership, your most important duty is gathering catch information. This will often take longer than on catcher/processors and involves coordination and cooperation with the vessel personnel. The fishing effort information required on the Vessel Haul Form should come from the delivering vessel’s NMFS logbook. You will rarely have access to this, but these data will be collected by the mothership captain, mate, or purser via a radio schedule broadcast. Some observers create a “worksheet” for the person doing the radio schedule, although most vessels will already have

Please let me know if there are any gear problems or marine mammal interactions reported by the catcher boats. Thanks!

| Del.# | Vessel Name | Date Set | Time Set | Set Latitude | Set Longitude | Bottom Depth | Fishing Depth | Date Retrieved | Time Retrieved | Retrieval Latitude | Retrieval Longitude | Catch Estimate |
|-------|-------------|----------|----------|--------------|---------------|--------------|---------------|----------------|----------------|--------------------|---------------------|----------------|
| 40 | M.D. | 01/25 | 1830 | 54.36' | 165.39' | 92F | 65F | 01/26 | 0025 | 54.37' | 165.39' | 36.90 |
| 41 | O.L. | 01/25 | 1810 | 55.29' | 164.49' | 85F | 68F | 01/25 | 2030 | 55.29' | 164.48' | 39.50 |
| 42 | Ald. | 01/25 | 2315 | 54.30' | 165.43' | 95F | 61F | 01/26 | 0335 | 54.30' | 165.64' | 38.32 |

Figure 6-1: Observer Radio Schedule Worksheet (example)

one. See Figure 6-1 as an example of an Observer Radio Schedule worksheet. If a crew member is getting haul data for you, make sure that they are gathering complete and accurate data from the catcher boats. Once this information is obtained, check carefully to ensure that no transcription errors are made when you copy data to the Vessel Haul Form. The data requested on the Observer Haul Form are those items which you are responsible for calculating or verifying. See “Recording VHF and OHF Data” on page 6-3

Electronic Logbooks

Motherships are required to use electronic logbooks (EDCPLs). Signed copies must be obtained and brought back for debriefing. Most of the Vessel Haul Form information will be gathered from the mothership delivery/radio worksheet, however you will need to obtain the delivery haul number from the EDCPL.

Vessel Type

On a CP acting as a mothership the “vessel type” code and the ADF&G column distinguish which hauls were self-made and which were deliveries. Use a vessel type “1” for self-made tows, and leave the ADF&G column blank. Use a vessel type “2” for codend deliveries. If your mothership pumps fish from the hold of another vessel, enter a vessel type “4,” indicating the delivery of potentially sorted catch. For all deliveries, enter the catcher vessel’s ADF&G number in the appropriate column (see Figure 6-2). At the top of the OHF, list the vessel names and corresponding ADF&G numbers for all catcher vessels delivering to your mothership. One list per data set is sufficient; you do not need a list on each page.

Haul Order for Motherships

Vessels acting as motherships exclusively document haul data in only one EDCPL. The retrieval information from the catcher vessel delivering to the mothership, determines the haul order on your haul forms. The delivering vessel’s retrieval date and time will not necessarily be the same day the codend was delivered to the mothership.

When filling out the VHF, you may find it easier to fill out the gear *retrieval* information first. You will avoid recording hauls on the wrong date if these columns are completed before recording gear *deployment* information.

Haul Order for CP/ Motherships

Vessels that act intermittently as motherships while fishing for themselves will have two electronic vessel logbooks (EDCPLs): one for their activity as a catcher processor and one for their activity as a mothership. The vessel will use a different haul numbering system between these two catch logs.

Remember that haul numbers do not have to be in consecutive ascending order, *but haul retrieval dates do*. You must list all hauls on the haul forms in ascending order by retrieval data, whether self fished or not. Use the vessel’s numbering system recorded in the catcher processor and in the mothership electronic logbooks accordingly.

Monitoring for Marine Mammals

Monitor the dumping of the codend for marine mammals in the catch. If you cannot monitor every delivery, this should be done on as many hauls as possible. If you monitor the dumping of the haul, record this haul as monitored for marine mammals. If your vessel, or the

catcher boats, report marine mammals nearby or possibly interacting with gear during haul back or delivery, this should be noted in your logbook.

Seabird Interactions and Sightings

Report observed bird interactions or sightings at the trip level on the Bird Interaction, Activity and Species Form in ATLAS. See Bird Sightings and Interactions on page 16-1 for a description of seabird data priorities.

Flow Scale - MCP Scale Weight Comparison Form and Flow Scale Test

Observers on CP trawlers and motherships equipped with a flow scale must collect the Flow Scale - MCP Comparison Test data and complete the Flow Scale - MCP Comparison Test Form in ATLAS (see “Flow Scale - MCP Scale Weight Comparison Form” on page 5-1). These vessels are also required to conduct the flow scale daily test in the presence of an observer. For information regarding testing flow scales, see “Flow Scale Testing” on page 2-31.

OBSERVER ESTIMATES

All motherships accepting pollock in the Bering Sea must have a motion compensated flow scale, as required by the American Fisheries Act. On these vessels, *observer estimates should be taken from the final flow scale read out*. If you are on a mothership that is not regulated by the AFA and does not have a flow scale, use the best method for obtaining independent catch estimates (see “Observer Estimates of Catch Weight” on page 4-6) and contact your inseason advisor.

CODEND DELIVERY DUTIES

Treat these deliveries as if your vessel caught the fish. Standard CP prioritized duties should be followed for each haul. These are:

- Collect and report salmon retention data.
- Obtain an independent observer estimate (i.e. the final flow scale weight).
- Sample for species composition.
- Collect biological data.
- Collect length frequency samples on prohibited and predominant species.

- Complete research projects.

Refer to the individual manual section regarding each one of these duties. See “BS Pollock Catcher Processors/Motherships” on page 5-36 for CP sampling guidelines.

Codend Delivery Problems

Usually codend transfers go smoothly. There are two situations that may complicate your ability to get delivery information or observer estimated catch weights. The first is when the codend is lost during transfer. In this situation, obtain the haul data from the delivering catcher vessel and ask them for an estimate of catch weight. Document this in the vessel estimate column of your OHF and leave the observer estimate field blank. Contact your inseason advisor to alert them of the incident.

The second situation is when the codend “leaks” fish during transfer. This may happen when the zipper is not secured. If you see fish spilling out from a codend during delivery, make an estimate of the tonnage lost and enter this weight to the estimated discard weight column in the OHF, and add it to the flow scale read out for your observer estimate. Again, notify your inseason advisor that the observer estimate did not come exclusively from the flow scale weight.

PUMPED FISH DELIVERY DUTIES

These fish have the potential to be sorted at sea, so they are treated differently than those delivered by codend transfer. *Do not sample these hauls for species composition*. If your vessel takes nothing but pumped fish, contact an Observer Program office for recording and sampling duties.

SALMON RETENTION DATA

Collect salmon retention data as you would on a CP. See “BS Pollock Catcher Processors/Motherships” on page 5-36 and “Salmon Retention Data in the Pollock Fishery” on page 12-16 for information.

RECORDING VHF AND OHF DATA

Maintain only one set of Vessel and Observer Haul Forms per gear type. List self-made tows and deliveries together, in the order which they were retrieved. If the vessel acts as a tender only and does not fish for itself record

non-fishing day positions only. See “DOCUMENTING FISHING EFFORT” on page 4-2 and “Completing Haul Forms on Trawl Vessels” on page 4-16 for rules and instructions on how to fill out the Vessel and Observer Haul Forms.

The particulars of these forms that are specific to motherships are listed and explained below.



Codend Delivery Rules

1. **Trip Number:** Record the trip number associated with the haul.
2. **Haul Number:** Enter the haul number for each codend delivery as it appears in the mothership electronic logbook under the Delivery Haul Number field (see Figure 6-2 on page 6-5).
3. **Vessel Type:** Enter a “2” to indicate that the vessel received unsorted catch.
4. **Gear Performance:** Gather this information from the delivering vessels. If no problems are reported, the default answer is “1.”
5. **Location Code:** Enter an “R.”
6. **Date and Time of Gear Deployment:** You will need to get this information from the delivering vessels. Remember that hauls must be listed by catcher vessels’ date of gear *retrieval*, so *deployment* dates and times may be out of sequence! Write the dates in two digit format (e.g., 01/01 for January 1st).
7. **Deployment Position, Average Bottom Depth, and Average Gear Depth:** Collect these data from the catcher boats. Degree, minute, and second entries must be two digits.
8. **Date and Time of Gear Retrieval:** Enter the day and time the catcher boat retrieved these hauls. It may be easier to fill these columns out first, so that your haul order is established before filling out the date, time and position of the beginning of the set. Write the dates in two digit format (e.g., 01/01 for January 1st).
9. **Retrieval Position:** Enter the corresponding latitude and longitude of the catcher boat’s retrieval position. Degree, minute, and second entries must be two digits.

Pumped Fish Delivery Rules

1. **Vessel type:** Enter a “4” to indicate that the vessel received potentially sorted catch.
2. **Gear Performance:** Gather this information from the delivering vessels. If no problems are reported, the default answer is “1.”
3. **Date and Time of Gear Deployment and Bottom Depth and Gear Depth:** Leave these columns blank. Often, pumped fish are made up of several hauls, so these data are not applicable.
4. **Date of gear retrieval:** Enter the day on which the delivery occurred. Write the dates in two digit format.
5. **Time of gear retrieval:** Enter the time when the delivery occurred.
6. **Location code:** Enter a “D” and the corresponding latitude and longitude of the mothership when it received the delivery.

Rules for Completing OHF information on a Mothership

1. **Full Name of Catcher Boat/ADF&G #:** Enter the name of the delivering catcher boat and its ADF&G number in the box located on the top right hand side of the OHF. You only need to list each boat once per data set. When all the lines on the first page are used up, go on to page 2, etc. Keep the catcher boat list together on the first several pages of your OHF.
2. **Vessel Estimate:** Enter the catch estimate made by mothership personnel in mt.
3. **Density and Volumetric Estimate:** Leave these columns blank.

4. **Haulback Bird Obs. Code:** This is always entered as "0" for No Monitoring.
5. **Short Wired:** This is always entered as "U" for Unknown.
6. **Catcher Boat's ADF&G #:** Enter the ADF&G number for the catcher boat which made this delivery.

| DAILY ELB REPORT | | | | VESSEL NAME | | | | Trip Name | | Report Date | | | | |
|------------------|------------------------|--------------------|---------------------|-----------------------------|------------------|----------------------|-----------------------|-----------------------------|------------------|-----------------------|----------------------|-----------------------|----------------|---------------------|
| MOTHERSHIP EDCPL | | | | MONEY | | | | A | | 07/05/2023 | | | | |
| | | | | OPERATOR NAME AND SIGNATURE | | | | ADF&G Vessel No | | | | | | |
| | | | | Rich Wright | | | | 76543 | | | | | | |
| | | | | | | | | Federal Fisheries Permit No | | | | | | |
| | | | | | | | | 1357 | | | | | | |
| CV or BS | RECEIVE DISCARD REPORT | MGMT PGM | NAME | ADF&G NO | RECEIPT TIME | RECEIPT POSITION | | FEDERAL REPORTING AREA | SPECIAL AREA | FISH TICKET NUMBER | DELIVERY HAUL NUMBER | TOTAL HAUL WEIGHT | SPECIES CODE | WT |
| | | | | | | LATITUDE | LONGITUDE | | | | | | | |
| CV | NC | AFA 100 | Fearless | 12345 | 05:04 | 64 56.3 N | 172 23.7 E | 519 | COBLZ | E23 234675 | 371 | 123.134 MT | 127 | 2.333 MT |
| CV | NC | AFA 100 | Fearless | 12345 | 06:05 | 65 55.4 N | 173 23.5 E | 519 | COBLZ | E23 234675 | 371 | 123.134 MT | 127 | 2.333 MT |
| | | | | | | | | | | | | 60 | 125 | 2.333 MT |
| | | | | | | | | | | | | 60 | 125 | 2.333 MT |

COMMENTS:

| FLOW SCALE TEST TIME | PLATFORM SCALE WEIGHT (kg) | FLOW SCALE WEIGHT (kg) | ERROR | PERCENT ERROR | OBSERVER PRESENT |
|----------------------|----------------------------|------------------------|--------|---------------|------------------|
| 10:16 | 1,245.00 | 1,234.00 | -11.00 | -0.88 | YES |

Delivery Haul Number: For all codend deliveries, use the haul number found in this field when completing the VHF and OHE.

Status: Sent Transmission Time: 07/16/2023 12:34 Last update: 07/06/2023 10:56 MONEY Page A-1

Figure 6-2: Mothership ELB Example

MOTHERSHIP DATA COLLECTION: RECORDING VHF AND OHF DATA

Vessel Haul Form

Page 1 of

| | | | |
|------------------------|-----------------------|---------------------|--|
| Cruise 26401 | Permit 4389 | Year 2023 | |
|------------------------|-----------------------|---------------------|--|

Observer Name Jim Page
Vessel Name The Ocean

| Trip No. | Haul No. | IFC? Y/N | CDQ No. | Gear Type | Vessel Type | Gear Performance | Location Code | Pur. Code | Deployment Information | | | | | | | | | | Retrieval Information | | | | | | | | | | | | | |
|----------|----------|----------|---------|-----------|-------------|------------------|---------------|-----------|------------------------|-----|------|--------------|------|------|--------|-----------|------|------|-----------------------|--------------------|--------|-----|-----|------|--------------|------|------|-----------|------|------|----|----|
| | | | | | | | | | Mo. | Day | Time | Latitude (N) | | | E or W | Longitude | | | Average Bottom Depth | Average Gear Depth | M or F | Mo. | Day | Time | Latitude (N) | | | Longitude | | | | |
| | | | | | | | | | | | | Deg. | Min. | Sec. | | Deg. | Min. | Sec. | | | | | | | Deg. | Min. | Sec. | Deg. | Min. | Sec. | | |
| 1 | 36 | N | C54 | 2 | 2 | 1 | R | CA | 01 | 24 | 1103 | 55 | 45 | 22 | W | 64 | 14 | 55 | 106 | 73 | F | 01 | 24 | 1215 | 55 | 43 | 32 | W | 64 | 15 | 01 | |
| 1 | 37 | N | | 2 | 2 | 1 | R | CA | 01 | 24 | 1602 | 54 | 32 | 39 | W | 65 | 18 | 27 | 111 | 102 | F | 01 | 24 | 1815 | 54 | 31 | 59 | W | 65 | 17 | 35 | |
| 1 | 38 | N | | 2 | 2 | 1 | R | CA | 01 | 24 | 1415 | 54 | 09 | 11 | W | 65 | 35 | 13 | 144 | 125 | F | 01 | 25 | 0028 | 54 | 11 | 56 | W | 65 | 35 | 48 | |
| 1 | 39 | N | | 2 | 2 | 2 | R | CA | 01 | 25 | 1602 | 54 | 32 | 06 | W | 65 | 18 | 47 | 111 | 106 | F | 01 | 25 | 2029 | 54 | 32 | 49 | W | 65 | 16 | 36 | |
| 1 | 40 | N | | 2 | 2 | 1 | R | CA | 01 | 25 | 1810 | 55 | 29 | 02 | W | 64 | 49 | 12 | 85 | 68 | F | 01 | 25 | 2030 | 54 | 29 | 40 | W | 64 | 48 | 16 | |
| 1 | 41 | N | | 2 | 2 | 1 | R | CA | 01 | 25 | 1830 | 54 | 36 | 09 | W | 65 | 39 | 21 | 92 | 65 | F | 01 | 26 | 0025 | 54 | 37 | 47 | W | 65 | 39 | 18 | |
| 1 | 42 | N | | 2 | 2 | 1 | R | CA | 01 | 25 | 2315 | 54 | 30 | 16 | W | 65 | 43 | 25 | 95 | 61 | F | 01 | 26 | 0335 | 54 | 30 | 38 | W | 65 | 42 | 59 | |
| 1 | 43 | N | | 2 | 4 | 1 | D | CA | | | | | | | | | | | | | | 01 | 26 | 0900 | 54 | 13 | 19 | W | 65 | 35 | 12 | |
| 1 | 44 | N | C54 | 2 | 2 | 1 | R | CA | 01 | 26 | 0601 | 55 | 02 | 10 | W | 65 | 33 | 17 | 91 | 80 | F | 01 | 26 | 0945 | 55 | 02 | 50 | W | 65 | 33 | 13 | |
| | 0 | | | | | | | N | | | | | | | | | | | | | | | 01 | 27 | | 55 | 53 | 12 | W | 66 | 31 | 10 |

Comments:

National Marine Fisheries Service/Fisheries Monitoring and Analysis Division - Ver. 2024

Observer Haul Form

Page 1 of

| | | | |
|------------------------|-----------------------|---------------------|--|
| Cruise 26401 | Permit 4389 | Year 2023 | |
|------------------------|-----------------------|---------------------|--|

Observer Name Jim Page
Vessel Name The Ocean

| | |
|---|-------------------------|
| Full Name of Catcher Boat Kashmir | ADF&G # 56782 |
| Ramble On | 78910 |
| Heartbreaker | 20194 |

| Haul No. | Haul Sampled By (Cruise No.) | RST On Haul? (Y=On, n=Off, x=NA) | RRT On Break? (Y=On Break, n=No Break) | Sample Design | Sample Unit Type | % Monitored for Marine Mammals | Gear descriptor | Fishing Method | Trawl Vessels | | | | Longline and Pot Vessels | | | | | | | | |
|----------|------------------------------|----------------------------------|--|---------------|------------------|--------------------------------|-----------------|----------------|-----------------------------------|-------------------------------|-------------------------------|------------|------------------------------|---------------------------------------|--------------|--------------------------------------|---|------------------------|---------------------|---|---|
| | | | | | | | | | Vessels Total Catch Estimate (mt) | Estimated Discard Weight (kg) | Observers Catch Estimate (kg) | B, C, or W | Density (kg/m ³) | Volumetric Estimate (m ³) | Hook Coll. # | # of Segments in Set (Longline Only) | Total Pots (or Hooks) in Set (required for pot vessel only) | Flow Scale Weight (MT) | Rel. Determin. Code | | |
| 36 | 26401 | X | N | 7 | 3 | 0 | | | 91.72 | 0 | 91724 | W | . | . | 0 | U | 56782 | . | . | . | . |
| 37 | 26401 | X | N | 7 | 3 | 100 | | | 29.43 | 0 | 29431 | W | . | . | 0 | U | 78910 | . | . | . | . |
| 38 | 26401 | X | N | 7 | 3 | 100 | | | 37.55 | 0 | 37550 | W | . | . | 0 | U | 20194 | . | . | . | . |
| 39 | 26401 | X | N | 7 | 3 | 100 | | | 26.15 | 0 | 26153 | W | . | . | 0 | U | 56782 | . | . | . | . |
| 40 | 26401 | X | N | 7 | 3 | 100 | | | 39.50 | 0 | 39502 | W | . | . | 0 | U | 78910 | . | . | . | . |
| 41 | 26401 | X | N | 7 | 3 | 100 | | | 39.90 | 0 | 39902 | W | . | . | 0 | U | 56782 | . | . | . | . |
| 42 | 26401 | X | N | 7 | 3 | 0 | | | 38.33 | 0 | 38325 | W | . | . | 0 | U | 20194 | . | . | . | . |
| 43 | 0 | X | N | | | 0 | | | 163.24 | | 163240 | W | . | . | 0 | U | 56782 | . | . | . | . |
| 44 | 26401 | X | N | 7 | 3 | 100 | | | 38.96 | 0 | 38961 | W | . | . | 0 | U | 20194 | . | . | . | . |
| 0 | | | | | | | | | . | . | . | | . | . | . | | . | . | . | . | . |

Comments:

National Marine Fisheries Service/Fisheries Monitoring and Analysis Division - Ver. 2024

Figure 6-3: Examples of VHF and OHF Form data from a Mothership

| Cruise | Permit | Year |
|--------|--------|------|
| 27078 | 9876 | 2023 |

Vessel Haul Form

Page 1 of 1

Observer Name David Paich

Vessel Name Rosanna

| Trip No. | Haul No. | IFG? Y/N | CDQ No. | Gear Type | Vessel Type | Gear Performance | Location Code | Deployment Information | | | | | | | | | | Retrieval Information | | | | | | | | | | | | | |
|----------|----------|----------|---------|-----------|-------------|------------------|---------------|------------------------|-----|------|------|--------------|------|------|--------|-----------|------|-----------------------|----------------------|--------------------|--------|-----|------|------|--------------|------|------|--------|-----------|------|------|
| | | | | | | | | Pur. Code | Mo. | Day | Time | Latitude (N) | | | E or W | Longitude | | | Average Bottom Depth | Average Gear Depth | M or F | Mo. | Day | Time | Latitude (N) | | | E or W | Longitude | | |
| | | | | | | | | | | | | Deg. | Min. | Sec. | | Deg. | Min. | Sec. | | | | | | | Deg. | Min. | Sec. | | Deg. | Min. | Sec. |
| 0 | | | | | | | N | | | | | | | | | | | | 08 | 31 | | | 53 | 53 | | W | 66 | 32 | | | |
| 1 | 521 | N | | 1 | 1 | R | CA | 09 | 01 | 1020 | 52 | 07 | 10 | W | 70 | 51 | 13 | 108 | 108 | F | 09 | 01 | 1340 | 52 | 02 | 29 | W | 70 | 49 | 06 | |
| 1 | 1301 | N | | 1 | 2 | R | CA | 09 | 01 | 1255 | 52 | 06 | 09 | W | 70 | 51 | 26 | 98 | 98 | F | 09 | 01 | 1520 | 52 | 07 | 22 | W | 70 | 50 | 12 | |
| 1 | 1302 | N | | 1 | 2 | R | CT | 09 | 01 | 1455 | 52 | 03 | 59 | W | 70 | 49 | 42 | 85 | 85 | F | 09 | 01 | 1915 | 52 | 06 | 11 | W | 70 | 50 | 17 | |
| 1 | 522 | N | | 1 | 1 | R | CA | 09 | 01 | 1845 | 52 | 03 | 45 | W | 70 | 49 | 58 | 83 | 83 | F | 09 | 01 | 2000 | 52 | 07 | 37 | W | 70 | 51 | 40 | |
| 1 | 1303 | N | | 1 | 2 | R | CA | 09 | 01 | 2045 | 52 | 06 | 15 | W | 70 | 50 | 31 | 80 | 80 | F | 09 | 01 | 2330 | 52 | 02 | 45 | W | 70 | 50 | 59 | |
| 1 | 523 | N | | 1 | 1 | R | CA | 09 | 02 | 0401 | 52 | 03 | 25 | W | 70 | 51 | 02 | 80 | 80 | F | 09 | 02 | 0940 | 52 | 02 | 13 | W | 70 | 50 | 16 | |
| 1 | 1304 | N | | 1 | 2 | R | CA | 09 | 02 | 0342 | 52 | 07 | 04 | W | 70 | 49 | 25 | 84 | 84 | F | 09 | 02 | 1205 | 52 | 05 | 41 | W | 70 | 49 | 42 | |
| 1 | 1305 | N | | 1 | 2 | R | CT | 09 | 02 | 1817 | 52 | 07 | 17 | W | 70 | 50 | 15 | 75 | 75 | F | 09 | 02 | 1916 | 52 | 03 | 28 | W | 70 | 49 | 13 | |
| 1 | 1306 | N | | 1 | 2 | R | CT | 09 | 02 | 1933 | 52 | 02 | 39 | W | 70 | 51 | 08 | 86 | 86 | F | 09 | 02 | 2031 | 52 | 02 | 35 | W | 70 | 50 | 29 | |
| 1 | 524 | N | | 1 | 1 | R | CT | 09 | 02 | 2104 | 52 | 06 | 47 | W | 70 | 49 | 11 | 78 | 78 | F | 09 | 02 | 2347 | 52 | 07 | 49 | W | 70 | 50 | 55 | |
| 0 | | | | | | | N | | | | | | | | | | | | | 09 | 03 | | | 53 | 53 | | W | 66 | 32 | | |

Comments: _____

| Cruise | Permit | Year |
|--------|--------|------|
| 27078 | 9876 | 2023 |

Observer Haul Form

Page 1 of 1

Observer Name David Paich

Vessel Name Rosanna

| Haul No. | Haul Sampled By (Cruise No.) | RST On Haul? (Y/N) | RBT On Break? (Y/N) | Sample Design | Sample Unit Type | % Monitored for Mammals | Gear Descriptor | Fishing Method | Trawl Vessels | | | | Longline and Pot Vessels | | | | | | | | | | | | | | | | | | | |
|----------|------------------------------|--------------------|---------------------|---------------|------------------|-------------------------|-----------------|----------------|-----------------------------------|-------------------------------|-------------------------------|------------|------------------------------|---------------------------------------|--------------|--------------------------------------|---|------------------------|--------------------|---|---|---|---|---|---|---|---|---|---|---|---|---|
| | | | | | | | | | Vessels Total Catch Estimate (mt) | Estimated Discard Weight (kg) | Observers Catch Estimate (kg) | B, C, or W | Density (kg/m ³) | Volumetric Estimate (m ³) | Hook Coll. # | # of Segments in Set (Longline Only) | Total Pots (or Hooks) in Set (requires log pot-vessel only) | Flow Scale Weight (MT) | Est. Observer Code | | | | | | | | | | | | | |
| 0 | | | | | | | | | | | | | | | | | | | | | | | | | | | | | | | | |
| 521 | 27078 | X | N | 7 | 3 | 100 | | | 71.38 | 4000 | 71383 | W | . | . | 1 | N | . | . | . | . | . | . | . | . | . | . | . | . | . | . | . | |
| 1301 | 27078 | X | N | 7 | 3 | 100 | | | 26.68 | 50 | 26684 | W | . | . | 0 | U | 40001 | . | . | . | . | . | . | . | . | . | . | . | . | . | . | |
| 1302 | 27078 | X | N | 7 | 3 | 100 | | | 34.75 | 150 | 34750 | W | . | . | 0 | U | 54123 | . | . | . | . | . | . | . | . | . | . | . | . | . | . | |
| 522 | 27092 | X | N | 7 | 3 | 100 | | | 29.76 | 500 | 29762 | W | . | . | 2 | N | . | . | . | . | . | . | . | . | . | . | . | . | . | . | . | |
| 1303 | 27092 | X | N | 7 | 3 | 100 | | | 16.76 | 100 | 16756 | W | . | . | 0 | U | 20194 | . | . | . | . | . | . | . | . | . | . | . | . | . | . | |
| 523 | 0 | X | N | | 0 | | | | 22.15 | | 22151 | W | . | . | 0 | U | | . | . | . | . | . | . | . | . | . | . | . | . | . | . | |
| 1304 | 27092 | X | N | 7 | 3 | 100 | | | 37.61 | 70 | 37605 | W | . | . | 0 | U | 40001 | . | . | . | . | . | . | . | . | . | . | . | . | . | . | |
| 1305 | 27092 | X | N | 7 | 3 | 100 | | | 70.03 | 300 | 70027 | W | . | . | 0 | U | 54123 | . | . | . | . | . | . | . | . | . | . | . | . | . | . | |
| 1306 | 27078 | X | N | 7 | 3 | 100 | | | 33.79 | 900 | 33788 | W | . | . | 0 | U | 20194 | . | . | . | . | . | . | . | . | . | . | . | . | . | . | . |
| 524 | 27078 | X | N | 7 | 3 | 100 | | | 72.17 | 20 | 72171 | W | . | . | 7 | Y | | . | . | . | . | . | . | . | . | . | . | . | . | . | . | |
| 0 | | | | | | | | | | | | | | | | | | | | | | | | | | | | | | | | |

If your vessel is both fishing for itself and receiving codends from other vessels, use the vessel's numbering system recorded in the catcher processor and in the mothership electronic logbooks accordingly.

Comments: Haul 523: Rough weather, unable to sample

Figure 6-4: Examples of VHF and OHF Forms for a vessel fishing itself and acting as a mothership

This page intentionally left blank

LONGLINE CATCH DATA COLLECTION



Table of Contents

| | |
|--|------|
| Priorities | 7-1 |
| Safety Concerns on Longliners | 7-1 |
| Documenting Fishing Effort | 7-4 |
| Daily Fishing Logbook (DFL) | 7-4 |
| Electronic Logbooks (ELB) | 7-6 |
| Fishing Effort from the Vessel Logbook | 7-6 |
| Fishing Effort Data: Vessels Under 60 ft | 7-7 |
| Estimating Discards | 7-8 |
| Verifying Gear | 7-9 |
| Hook and Segment Data | 7-10 |
| Counting Hooks | 7-10 |
| Verifying the Number of Segments in a Set | 7-11 |
| Partial Segments | 7-11 |
| Accounting for Mixed Gear | 7-13 |
| Calculating Total Hooks in the Set | 7-14 |
| Calculating Total Hooks in Your Sample | 7-15 |
| Hook Spacing | 7-15 |
| Offload Data for Longliners | 7-16 |
| Determining Offload Delivery Weight | 7-16 |
| Obtaining Your Fish Ticket | 7-16 |
| Landing Report Verification | 7-16 |
| Offload Form Instructions | 7-17 |
| Recording VHF and OHF Data | 7-18 |
| Completing the Vessel Haul Form | 7-18 |
| Completing the Observer Haul Form | 7-21 |
| Hook Count and Spacing Form Instructions | 7-23 |
| Snap gear | 7-23 |
| Snap Gear Verification: Counting Hooks | 7-24 |
| Snap Gear Hook Count and Spacing Form Instructions | 7-25 |

PRIORITIES

- Your safety!
- Record the vessel's total fishing effort for every set retrieved.
- Determine average hooks per segment, verify and document total segments per set.
- Collect Hook Spacing data in all Sablefish IFQ and CDQ fisheries (and not using snap gear).
- Send data to the Observer Program as directed (see "Sending Data" on page 2-39).
- Document any compliance concerns.
- Record calculations and daily notes.

SAFETY CONCERNS ON LONGLINERS

It is always your highest priority to stay safe and be aware of your surroundings aboard every vessel. Remember that every vessel is different and fishing situations are constantly changing. There are several safety concerns specific to longliners.

When sampling on longliners, you stand outside for long periods of time and are exposed to the elements. In the winter months, you could experience freezing conditions, snow, spray and high winds. Summer weather can be chilly. The Observer Program provides insulated coveralls and you are strongly encouraged to bring additional winter clothing if you know you will be deployed on a longliner.

On some vessels the “tally station” (where you stand to tally species composition samples) is on the deck above the rollerman. On others, you sample next to the roller station (also called the haul station). Roller stations are usually open areas near the water line. It is not uncommon to have a wave come through the roller station and you need to be alert to this possibility. Additionally, the roller station is full of moving hooks and line. When a moving line wraps around an arm or leg it can drag a person into machinery. Moving hooks are also a threat. It is not uncommon for crew members to be seriously injured by incoming and outgoing hooks.

The Observer Program expects you to be proactive about your own safety by wearing a personal flotation device whenever you are working on deck, even if you think your sample station is not openly exposed to the elements. You should always notify the captain or crew if you plan to be, or think you will be, out on deck alone.

GENERAL DESCRIPTION OF OPERATIONS

The primary target species in the longline fisheries are Pacific Cod, Sablefish (Black Cod), Pacific Halibut, and Greenland Turbot. Often, longline vessels also retain incidentally caught species such as skates, rockfish, Arrowtooth Flounder, and pollock. The species retained depends upon fishing regulations, such as IR/IU, and upon market prices. Some incidentally caught species are only retained if market prices are high at the time.



Longliners in the North Pacific fish with baited hooks on a line that lies on or near the sea floor. The “backbone” of the gear is the line or “groundline.” The length of the groundline depends on the size of the vessel and the species

targeted. Hooks are attached to the groundline by another thinner line, called a gangion (pronounced “gan-yun”). The length of the gangion and the distance between gangions is different depending on the target

fishery and vessel. There is an anchor on each end of the groundline (there may be more along the line) and buoys are attached to each of the anchors by buoy lines (see Figure 7-1).

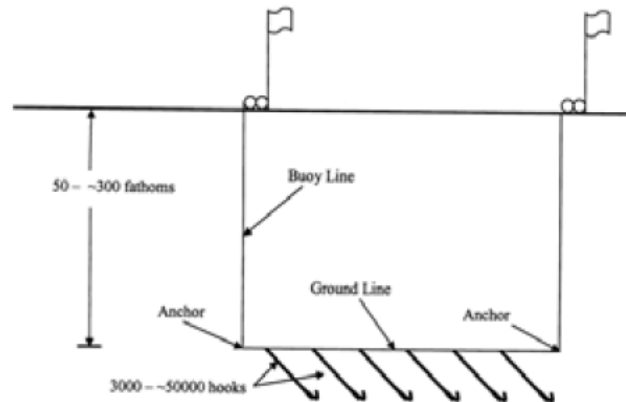

Figure 7-1: Typical Longline Configuration

Longline fishers further divide their gear into smaller segments in order to handle it aboard the vessel. A longline haul (referred to as a “set” or “string”) consists of several segments of gear tied together by the groundline. Segments of gear can be configured as magazines (“mags”), rails, skates, coils, or tubs. The crew may either use these terms interchangeably or to indicate a specific amount of gear.



Your vessel may call segments of gear “mags”, skates, tubs, coils, racks or rails. We’ll just call them segments.

This gear is often referred to as “stuck gear” or “fixed hooks” as the total number of hooks remains relatively constant per segment because hooks are permanently attached to the groundline. Fixed hook gear is used by the majority of the longline vessels in Alaska.

On some vessels, hooks are baited by hand and the gear is set directly from tubs or canvas mats. Crew tie gear together by the groundline just prior to, or during, the deployment of the gear. On other vessels, a mechanized “autobaiter” is used to bait gear and the gear is deployed from this machine. Longline gear is set by dropping the buoy and anchor from one end of the groundline out the aft of the vessel. The rest of the gear quickly trails out as the anchor sinks. On the last segment of the set, another anchor and buoy are tied to the end of the line

and deployed. The gear is allowed to soak for some time before retrieval.

Longline gear is retrieved by pulling in the groundline so that the hooks come aboard one at a time. The line comes in over the roller, through the crucifier, over the block, and then is either coiled or hung onto racks by the hooks.

Usually longliners set multiple strings, let them soak, and then rotate between hauling and resetting the gear. This cycle may be continued for many sets per day.

Snap Gear

A less common type of longline gear is snap gear. A snap gear longline vessel will set a long continuous line (considered to be a single segment) with hooks snapped-on



during the setting in variable intervals. The hooks are then removed during retrieval. There is no crucifier to remove fish, otherwise operations are very similar to fixed hook longline operations. See “Snap gear” on page 7-23 for a more detailed description of snap gear operations.

Longline Catcher Processor (CP) Vessels

Longline CPs usually conduct fishing operations 24 hours a day, 7 days a week, and have crew members working in shifts. You will need to schedule your work time not only to achieve sampling objectives but also to get adequate rest. Lack of adequate rest is a safety concern. Your safety is the highest priority!

Processing strategies aboard CP longliners will vary vessel to vessel, but generally speaking the operation can be summarized as follows: 1) as the gear is retrieved, fish are removed from the hooks by the crucifier or rollerman



and enter the factory area through a series of conveyor belts or troughs, 2) in the factory, fish are mechanically or manually sorted by species and size, 3) processed fish are panned and frozen, and 4) finished product is stored in freezer holds.

To sample effectively aboard longliners, you need to communicate with the crew, especially with the rollermen. This can be difficult aboard CPs because the rollermen may not always be able to see you, hear you or understand you. Upon boarding a vessel, seek out the factory manager(s) and the rollermen. Explain your needs before they begin setting gear and you begin sampling. Experienced crew may have suggestions based on how they have worked with previous observers. This may be good information, but you alone need to decide where and how you will sample to obtain the best data. Prior to the first gear retrieval, work out a communications system with the rollerman. For every sampled set, inform the rollerman of your sampling needs. Try different techniques and be creative to achieve your sampling goals.



Refer to “Catcher Processor (CP) Monitoring Options” on page 8-23 for information regarding observer coverage, sample station options, and flow scales.

Longline Catcher-Only Vessels

Catcher-only longliner vessels are similar to CP longliners in that the gear is deployed and retrieved in a similar manner. Most of the differences between the two vessel types are in the scale of operations. Catcher-only longliners tend to have smaller crews, set fewer hooks and catch less fish. Most catcher-only vessels hand bait their hooks, but a few use autobaiters. Some will set and retrieve gear such that the entire crew gets a 6-8 hour sleep break.

Additionally, catcher-only longliners periodically deliver their catch to processors. You may get some downtime on the way to and from town to complete paperwork and catch up on sleep.



When choosing a sampling area on a catcher-only longliner, work closely with crew members. Space is limited and there may not

be a permanent observer sampling station. Be creative; you may need to use baskets or bin boards to construct a sample table, or use the hold hatch cover. Look around, talk to the crew and use what space is available.

DOCUMENTING FISHING EFFORT

This chapter covers the collection of fishing information for longline and pot vessels. You will use this information for the Vessel Haul Form (VHF) and Observer Haul Form (OHF).

Logbook Requirements for Vessels 60 ft or Greater

All vessels greater than or equal to 60 feet in length overall are required by federal regulation to maintain a current NMFS "Alaska Groundfish" Daily Fishing Logbook (DFL) or use an Electronic Logbook (ELB). The captain or an assigned crew member must enter details of fishing activities, effort, and catch in the logbook. Under regulation 50 CFR 679.50, observers have the right to inspect and copy the NMFS logbook and all other documentation of fishing effort.

Daily Fishing Logbook (DFL)

Catcher vessels greater than or equal to 60 feet in length can use either a "paper" Daily Fishing Logbook (DFL)

or an Electronic Logbook (ELB). See Figure 7-2 on page 7-4 for an example of a DFL paper "Goldenrod" page. Observers must collect copies of the DFL pages labeled "Goldenrod Observer copy".

Logbook Requirements for Vessels Under 60 ft

Vessels less than 60 feet are not required to use an NMFS logbook, so you must collect haul data for the VHF and OHF forms from an alternate source (without the convenience of the NMFS Logbook). Haul data should be recorded directly onto the haul forms from a logbook when possible. Vessels retaining halibut must maintain an International Pacific Halibut Commission (IPHC) logbook.

Vessels not retaining halibut may use an alternative method of logging catch information, such as a personal notebook or unofficial logbook. You are allowed access to this data while on board the vessel. Vessels under 60 ft are not required to provide copies of their personal notes of haul data. Document in your daily notes if the original data is recorded straight onto the haul forms and copies of raw data were unavailable.

COPY DISTRIBUTION:
 Revised: 5/11/2018 **WHITE** Vessel Copy; **Keep in Logbook** • **GREEN** IFO Distribution • **GOLDENROD** Observer copy • **BLUE** Discard Report Submit to Processor • **YELLOW** NMFS Copy; Remit

OMB Control No. 0648-0213
 Expiration Date: 06/31/2021

| | | | | | | | | | | | | | | | | | | |
|---|--|---|--------------------------------|--|---|---------------------------------------|---|---------------------------------------|-----------------------------|------------------------|------------------------------------|----------------------------------|------------------------------------|----------------------------------|---------------------|---|--|---|
| CATCHER VESSEL DFL LONGLINE AND POT GEAR | | VESSEL NAME BIG SHOT | FEDERAL CRAB VESSEL PERMIT NO. | BY/DATE ONLY 7 | | | | | | | | | | | | | | |
| OPERATOR NAME AND SIGNATURE <i>William Joel</i> | | ADDRESS ONLY 38915 5361 | | | | | | | | | | | | | | | | |
| INACTIVE | START | END | REASON | FEDERAL REPORTING AREA 64D | | | | | | | | | | | | | | |
| IDENTIFICATION | | OBSERVER INFORMATION | | | | | | | | | | | | | | | | |
| IFO Permit # 158818 IFO Permit # 3472 | | CDQ Group # Halibut CDQ Permit # OBSERVER NAME & CRUISE # Debbie Harry 25410 OBSERVER NAME & CRUISE # | | | | | | | | | | | | | | | | |
| MANAGEMENT PROGRAM <input type="checkbox"/> CDO <input type="checkbox"/> Exempted <input type="checkbox"/> Research <input type="checkbox"/> AIP | | CREW SIZE 5 GEAR TYPE (check one) <input checked="" type="checkbox"/> Pot is longline set? <input type="checkbox"/> YES <input type="checkbox"/> NO <input type="checkbox"/> J <input type="checkbox"/> T <input type="checkbox"/> H <input type="checkbox"/> L <input type="checkbox"/> M <input type="checkbox"/> O <input type="checkbox"/> P If none & size or longline pot, complete appropriate boxes below. | | | | | | | | | | | | | | | | |
| IFO Permit # 158818 IFO Permit # 3472 | | GEAR ID A <input checked="" type="checkbox"/> B <input type="checkbox"/> C <input type="checkbox"/> D <input type="checkbox"/> | | | | | | | | | | | | | | | | |
| IFO Permit # 157485 IFO Permit # 2692 | | Length of gear (ft) (to nearest ft) Set hook to set Spacing hook to set No. hooks per set 800 15 42in 225 | | | | | | | | | | | | | | | | |
| Complete these boxes once per delivery | | | | | | | | | | | | | | | | | | |
| CATCH BY SET | SET # | DATE & TIME VMS SET | HAILED | Study of tag # | BEGIN POSITION LATITUDE LONGITUDE | END POSITION LATITUDE LONGITUDE | SEGN & END DEPTH (Fath.) | GEAR ID | NUMBER OF SKATES OR POTS | TARGET SPECIES CODE | CDQ/IFO HALIBUT (Permit No.) | IFO SABL CRAB (Permit No.) | CR CRAB | HAUL WEIGHT LBS | BIOD. ACC'D GEAR | Mammals (No.) Weighted white haulings | Number stragglers | |
| | 23 | 3-24 1550 | 3-24 1000 | 90 | 59 33 19 144 36 40 | 69 59 31 15 144 32 45 | 83 165 | A | 18 | 200 | 260 | 60 | | 3000 | 1 | Sperm Other None | Subfish Halibut Other fish None | |
| | 24 | 3-24 1550 | 3-24 1000 | 5 | 59 30 40 144 37 34 | 91 59 32 51 144 41 52 | 240 95 | | 18 | | 4150 | 190 | | | 5500 | 1 | Sperm Other None | Subfish Halibut Other fish None |
| | 25 | 3-24 1550 | 3-24 1000 | 90 | 59 33 56 144 34 77 | 69 59 31 80 144 31 55 | 74 10 | | 15 | | 2470 | | | | 2550 | 1 | Sperm Other None | Subfish Halibut Other fish None |
| | 26 | 3-24 1550 | 3-24 1000 | 92 | 59 32 17 144 29 58 | 93 59 33 70 144 32 86 | 78 15 | | 15 | | 2150 | 50 | | | 2800 | 1 | Sperm Other None | Subfish Halibut Other fish None |
| | 27 | 3-25 1050 | 3-25 1050 | 90 | 59 32 77 144 38 65 | 69 59 31 09 144 35 53 | 88 130 | | 15 | | 3140 | 10 | | | 4200 | 1 | Sperm Other None | Subfish Halibut Other fish None |
| | 28 | 3-25 1050 | 3-25 1050 | 5 | 59 33 41 144 43 93 | 91 59 35 25 144 47 20 | 80 163 | | 15 | | 2820 | | | | 2700 | 1 | Sperm Other None | Subfish Halibut Other fish None |
| | 29 | 3-25 1410 | 3-25 1410 | 69 | 59 32 07 144 42 49 | 90 59 31 01 144 40 74 | 95 111 | | 10 | | 600 | | | | 650 | 1 | Sperm Other None | Subfish Halibut Other fish None |
| | For groundfish and Pacific herring, circle: (0) or nearest 0.001 mt. For Pacific halibut, Pacific salmon, king crab, and Tanner crab, record in numbers. | | | | | | | | | | | | | | | | | |
| | DISCARD POSITION | | DATE | TIME SET | HAILED | Study of tag # | BEGIN POSITION LATITUDE LONGITUDE | END POSITION LATITUDE LONGITUDE | SEGN & END DEPTH (Fath.) | GEAR ID | NUMBER OF SKATES OR POTS | TARGET SPECIES CODE | CDQ/IFO HALIBUT (Permit No.) | IFO SABL CRAB (Permit No.) | CR CRAB | HAUL WEIGHT LBS | BIOD. ACC'D GEAR | Mammals (No.) Weighted white haulings |
| | | 3-24 | 3-24 | 3-24 | 3-24 | 3-25 | 3-25 | 3-25 | 3-25 | | | | | | | | | |
| | | 700 | 691 | 200 | 130 | 700 | 691 | 200 | 130 | | | | | | | | | |
| | | 98 | 98 | 98 | 98 | 98 | 98 | 98 | 98 | | | | | | | | | |
| | | 500 | 500 | 200 | 500 | 500 | 500 | 200 | 500 | | | | | | | | | |
| | | 500 | 500 | 200 | 500 | 1000 | 1000 | 400 | 1500 | | | | | | | | | |
| COMMENTS: <i>Halibut Discards were undersized & released carefully</i> | | | | | | | | | | | | | | | | | | |
| DELIVERY | | DATE | ATP ACFT TICKET NO. | RECEIPT'S NAME OF FOREGOING DELIVERER | UNLOADING POINT | BIOD. LOG ONLY | | | | | | | | | | | | |

Figure 7-2: Vessel Logbook Example

Regardless of what your vessel is using to document their fishing effort, you must obtain all basic haul information and report it on the Vessel and Observer Haul Forms. *These data are expected to be verified on a daily or haul-by-haul basis during a trip to ensure they are accurate.*

hauls in the management code column next to the set number (see Figure 7-3).

The Greenland Turbot longline fishery is not an IFQ fishery therefore you do not mark the VHF as being in IFQ, even if the vessel is retaining Sablefish due to an IFQ permit holder on board.

Vessels Fishing IFQ

All longline and pot vessels (IFQ and non-IFQ) use the same type of logbook. Data are entered differently depending on whether the vessel is fishing for IFQ species or not. If you are unsure whether or not the vessel is fishing IFQ consult the captain. For a more detailed description of IFQ see “Individual Fishing Quota (IFQ)” on page 8-24.

IPHC Logbooks

Vessels retaining Pacific Halibut must use a logbook provided by the International Pacific Halibut Commission (IPHC). If they are over 60 feet, they must complete the IPHC logbook and an NMFS DFL or ELB (logbook). You are allowed access to this catch information. The IPHC logbook does not contain a goldenrod observer copy, so you will not retain a copy of the IPHC logbook for your data when you disembark the vessel. Some of the haul data you are required to report can be found in the IPHC logbook, but some data points recorded in the IPHC logbook may not match the observer program definitions for haul data described in the manual. Use this IPHC data only if the vessel does not provide you with data as defined in the manual and you cannot

Fishing IFQ is shown in the logbook by the IFQ permit number listed on the upper left-hand corner of the DFL and an entry greater than 0.00 in the columns “IFQ Halibut” and/or “IFQ Sablefish.” Look for both entries. See “Vessel Logbook Example” on page 7-4; all hauls in the logbook page in Figure 7-2 are IFQ hauls. Fixed gear vessels using electronic logbooks (ELB) will denote IFQ

| DAILY ELB REPORT | | | | VESSEL NAME Warrior | | | | | | | | | | | | | | Trip Name B | | Report Date 01/26/2023 | | | |
|--|-----------|----------------------------|-------------|---|-----------------------------------|----------------------|---------------------------------|-----------------------------------|-------------|------------------|----------------------|-----------------------------------|---------|-----------|--------------------------|-------------------------|-----------------|--------------------------|----------------|--------------------------------------|--------------|--------------------------------------|--|
| CP LONGLINE & POT GEAR | | | | OPERATOR NAME AND SIGNATURE David Drainman | | | | | | | | | | | | | | ADF&G Vessel No. 2285 | | Federal Fisheries Permit No. 7253 | | | |
| SET NO. | MGMT FROM | TIME SET | TIME HAILED | Buoy or Bag # | BEGIN POSITION LATITUDE LONGITUDE | Buoy or Bag # | END POSITION LATITUDE LONGITUDE | FEDERAL REPORTING AREA | BEGIN DEPTH | END DEPTH | IPHC OFFICE USE ONLY | TARGET SPECIES CODE | GEAR ID | GEAR TYPE | NUMBER OF SKATES OR POTS | | BIRD AVOID GEAR | FLOW SCALE WEIGHT | HAUL WEIGHT | SPECIES CODE | WT | NO. | |
| | | | | | | | | | | | | | | | SET | LOST | | | | | | | |
| 32 | OA | 01/26 16:16 | 01/27 05:45 | | 59 07.5 N 173 31.0 W | | 59 07.5 N 173 54.3 W | 521 | 63 FM | 67 FM | | 110 | 61A | AL | 15 | 0 | 1 | 6.030 0 MT | 7.6000 MT | 110 | 6.0340 MT | | |
| | | | | | | | | | | | | | | | 60 Sold | | | | 270 | 0.2080 MT | | | |
| 33 | OA | 01/26 19:10 | 01/27 16:00 | | 59 13.7 N 173 45.6 W | | 59 13.7 N 174 13.2 W | 521 | 64 FM | 67 FM | | 110 | 61A | AL | 18 | 0 | 1 | 9.600 0 MT | 10.800 0 MT | 110 | 9.5970 MT | | |
| | | | | | | | | | | | | | | | 60 Sold | | | | 270 | 0.5980 MT | | | |
| COMMENTS: | | | | | | | | | | | | | | | | | | | | | | | |
| FLOW SCALE TEST TIME | | PLATFORM SCALE WEIGHT (kg) | | FLOW SCALE WEIGHT (kg) | | ERROR | | PERCENT ERROR | | OBSERVER PRESENT | | COMMENT | | | | | | | | | | | |
| 17:20 | | 451.20 | | 437.60 | | -13.60 | | -3.01 | | YES | | FAILED TEST | | | | | | | | | | | |
| 17:30 | | 451.20 | | 449.90 | | -1.30 | | -0.29 | | YES | | | | | | | | | | | | | |
| Status: Receipt Received Transmission Time: 01/27/2023 08:10 Last update: 01/28/2023 23:08 | | | | | | | | | | | | | | | WARRIOR Page B-1 | | | | | | | | |
| ELB TRIP REPORT | | | | VESSEL NAME Warrior | | | | | | | | | | | | | | Trip Name B | | ADF&G Vessel No. 2285 | | Federal Fisheries Permit No. 7253 | |
| OPERATOR NAME AND SIGNATURE David Drainman | | | | | | | | | | | | | | | | | | | | | | | |
| GEAR ID | GEAR TYPE | LENGTH OF SKATE (feet) | HOOK Size | HOOK Spacing (feet) | HOOKS Per Skate | Percent with swivels | Swivels on hooks | Swivels on snags | | | | | | | | | | | | | | | |
| 63A | AL | 4620 | 13 (100%) | 3.5 | 1320 | 100 | ✓ | | | | | | | | | | | | | | | | |
| 63B | AL | 4550 | 13 (100%) | 3.5 | 1300 | 100 | ✓ | | | | | | | | | | | | | | | | |
| Trip Start Date 01/26/2023 | | | | Crew Size 20 | | | | | | | | | | | | | | | | | | | |
| OBSERVER INFORMATION | | | | OBSERVER NAME AND CRUISE NUMBER # | | | | OBSERVER NAME AND CRUISE NUMBER # | | | | OBSERVER NAME AND CRUISE NUMBER # | | | | NO. OF OBSERVERS ABOARD | | | | | | | |
| | | | | Monica Geller 21053 | | | | | | | | | | | | 1 | | | | | | | |
| ACTIVITY | | | | ACTIVITY DATE | | | | REASON | | | | | | | | | | | | | | | |
| Go Active | | | | 01/26/2023 | | | | | | | | | | | | | | | | | | | |
| Go Inactive | | | | 02/21/2023 | | | | going to town to offload | | | | | | | | | | | | | | | |
| Status: Receipt Received Transmission Time: 02/19/2023 Last update: 02/21/2023 05:27 | | | | | | | | | | | | | | | WARRIOR Page B-0 | | | | | | | | |

Figure 7-3: Daily ELB Report and Trip ELB Report Examples

independently collect fishing information. Information collected from the IPHC logbook must be verified like all other catch data. See “Figure 7-5: IPHC Logbook” on page 7-8 for an example of an IPHC Logbook page.

Electronic Logbooks (ELB)

Some catcher vessels will use an electronic logbook (ELB); however, by regulation, all catcher processors and motherships with flow scales must use an ELB. This software captures the same information as the paper versions and is sent to the Alaska Regional Office electronically daily. If your vessel is using an ELB, you must bring back signed copies of the Daily ELB Report printouts, including the ELB Trip Report pages for non-fishing days, in place of “Goldenrod” copies. Request a signed copy of all revisions made to the ELB. Examples of the Daily ELB printout and the Trip ELB printout are shown in Figure 7-3 on page 7-5.



Observers should never give advice to the vessel regarding ELBs. The vessel should contact the Alaska Regional Office directly for guidance.

Verifying Fishing Effort Information

Before copying anything from the vessel logbook to your data forms, ensure you understand what information the captain is documenting. You must determine the accuracy of the information and whether it represents the information you need to report. For example, on the Vessel Haul Form (VHF), the deployment time must indicate the first hook in the water. Does the captain know this is the information you need, and are they recording deployment times of the first hook in the water, not the last? Don’t assume the vessel captain knows what data you need to collect! There are both newer and older versions of the vessel logbooks, with some variations in format. Please consult the captain if you have questions regarding the vessel logbook entries. Haul data should be recorded directly onto the haul forms from a logbook when possible.

Fishing Effort from the Vessel Logbook

Transfer the following information from the vessel logbook to your Vessel Haul Form (VHF) and Observer Haul Form (OHF) See Figure 7-9 on page 7-27 for examples of proper documentation for these data).

- Haul (Set) numbers. *If you are unable to make haul numbers match the ELB, contact your in-season*

advisor.

- Individual Fishing Quota (IFQ), Yes or No
- Community Development Quota (CDQ) group number, if applicable
- Date and Time of Gear Deployment
- Date and Time of Gear Retrieval
- Position of Gear Deployment (latitude and longitude)
- Position of Gear Retrieval (latitude and longitude)
- Average Bottom Depth
- Number of Segments Retrieved
- Vessel estimate
- Flow Scale Weight (CP caught Pacific Cod only)

In addition, record any gear performance problems. This information is not recorded in the vessel logbook. Ask the person responsible for logbook entries to record problems with the gear for you somewhere on the logbook page or on a separate page.

For as many sets as possible, you will need to verify the following entries:

- **Date and Time of Gear Deployment and Retrieval:** The documented time of gear deployment should represent the first hook in the water. The documented time of gear retrieval should represent when the last hook came out of the water. When possible, for each set, independently note the time when the crew begins to deploy hooks and when they retrieve the last hook for that set. You may be unable to verify deployment or retrieval times for all sets. For unverified sets, rely on the information provided by vessel personnel in the vessel’s logbook. If your vessel’s logbook contains erroneous times, let the crew member in charge of the logbook know about the error. If the incorrect data continues to be logged, consult the Observer Program for advice on recording your set data.
- **Position of Gear Deployment and Retrieval:** The latitudes and longitudes entered in the “Begin Position of Haul” and “End Position of Haul” columns in the vessel’s logbook should be the position of the first hook set and the last hook retrieved. The captain or mate

read these positions from the GPS navigation systems located on the bridge. Seconds must be documented on the VHF only if they are recorded by the vessel. If no seconds are recorded, leave it blank. Do not enter "00" as this creates a defined position in geographical space which is incorrect. Occasionally check that the positions in the vessel's logbook match the GPS readings. The person responsible for the logbook may have incorrectly entered the position. Question any large changes in position between one set and the next or long distances between set and retrieval positions.

even if this estimate is only of retained catch. Document and inform your inseason adviser that the non-retained species were not included in the vessel estimate as this is a potential violation.

If your vessel is not required to keep a NMFS logbook you will need to ask the captain for an estimate for each haul. If the captain does not give you an actual weight for the vessel estimate do not record your own estimate. Document that the captain did not give you a catch estimate and notify your inseason adviser.

Gear Performance Codes

This code indicates if there were problems with the gear that may have affected the amount of fish caught. These are sometimes noted in the vessel logbook or may be based on your own observations. Note in the comments section of the VHF and your Daily Notes the reasons for using gear performance codes other than code "1 - No problems."

Fishing Effort Data: Vessels Under 60 ft

Vessels not required to complete an NMFS logbook must cooperate with the observer to provide the necessary catch data. You must clearly inform the captain of your needs so that they can assist you with obtaining accurate and timely information. This discussion should occur immediately upon embarking on the vessel. You may need to alter your request for information during your trip as you gain experience with the data.

Vessel Estimates

The vessel estimate is the captain's estimate of total catch for a haul, sometimes referred to as the "haul weight". This estimate should include all retained and non-retained species. Always use the weight recorded by the captain,

If the vessel's captain cannot provide you with the needed information, you will be expected to collect haul data independently. You may need to adjust your other duties to adapt to the additional time required to collect catch information. Document this in your daily notes to ensure you meet program expectations.

Fishing Effort Summary for Fixed Gear Vessels Page _____ of _____

The information collected on this form is intended to be utilized only by the assigned observer to complete their required data collections. Vessel Name _____ ADF&G number _____

| Haul No. | CDQ # | IFQ | Deployment Information | | | | Average bottom depth ft or M (circle one) | Retrieval Information | | | | Total Segs. | Total hooks/pots | Catch estimate Lb or MT (circle one) | Gear problem? | |
|----------|-------|--------------------------|------------------------|-----|------------|--------------|--|-----------------------|-------|-----|------------|-------------|------------------|--|---------------|--------------------------|
| | | | Month | Day | Time (ALT) | Latitude (N) | | Longitude | Month | Day | Time (ALT) | | | | | Latitude (N) |
| | | <input type="checkbox"/> | | | | | | | | | | | | | | <input type="checkbox"/> |
| | | <input type="checkbox"/> | | | | | | | | | | | | | | <input type="checkbox"/> |
| | | <input type="checkbox"/> | | | | | | | | | | | | | | <input type="checkbox"/> |
| | | <input type="checkbox"/> | | | | | | | | | | | | | | <input type="checkbox"/> |
| | | <input type="checkbox"/> | | | | | | | | | | | | | | <input type="checkbox"/> |
| | | <input type="checkbox"/> | | | | | | | | | | | | | | <input type="checkbox"/> |
| | | <input type="checkbox"/> | | | | | | | | | | | | | | <input type="checkbox"/> |
| | | <input type="checkbox"/> | | | | | | | | | | | | | | <input type="checkbox"/> |
| | | <input type="checkbox"/> | | | | | | | | | | | | | | <input type="checkbox"/> |
| | | <input type="checkbox"/> | | | | | | | | | | | | | | <input type="checkbox"/> |
| | | <input type="checkbox"/> | | | | | | | | | | | | | | <input type="checkbox"/> |
| | | <input type="checkbox"/> | | | | | | | | | | | | | | <input type="checkbox"/> |
| | | <input type="checkbox"/> | | | | | | | | | | | | | | <input type="checkbox"/> |
| | | <input type="checkbox"/> | | | | | | | | | | | | | | <input type="checkbox"/> |
| | | <input type="checkbox"/> | | | | | | | | | | | | | | <input type="checkbox"/> |
| | | <input type="checkbox"/> | | | | | | | | | | | | | | <input type="checkbox"/> |

Definitions:

Deployment date/time/position: When the first hook/pot enters the water **Catch Estimate:** Visual estimate of total catch including bycatch in lbs or kgs **IFQ:** Check the box if IFQ

Retrieval date/time/position: When the last hook/pot left the water **Gear Problem ?:** Was there any issues with gear if so check the box

CDQ: Indicate CDQ with the CDQ number otherwise, leave blank **Total Segs.:** Total number of gear segment retrieved **Total hooks/pots:** Total number of hooks or pots retrieved

Updated 11/8/2012

Figure 7-4: Optional Fishing Effort Summary Form for Fixed Gear Vessels

LONGLINE CATCH DATA COLLECTION: ESTIMATING DISCARDS

If the data you are collecting deviates from the definitions listed in the Observer Sampling Manual, you must document this information in your daily notes. As with all catch information, this data is expected to be verified daily or haul by haul during a trip to ensure accuracy. If haul information is collected in another manner (Fishing Effort Summary, written on a post-it note, notebook page), this raw data should be retained and returned with you for debriefing (if possible). Vessels under 60 ft are not required to provide copies of their personal notes of haul data. Document in your daily notes if the original data is recorded straight onto the haul forms.

Fishing Effort Summary Form for Fixed Gear

To facilitate easy data sharing, you must offer the captain the "Fishing Effort Summary for Fixed Gear Vessels" Form. This form is pre-formatted to make it simple for the captain to provide the data you need to complete your work. This summary form is not a regulatory form, but the observer will use it to perform their required duty. A vessel may fill out all, some, or none of this form. However, if they do not fill it out, they should be informed that you must collect this information through other means.

Fishing Effort and IPHC Logbooks

Vessels under 60 ft retaining halibut must record their catch in the IPHC logbook. Before using the IPHC logbook, offer the captain the option of using the Fishing Effort Summary Form. Discuss with the captain your data requirements. Some of the haul data you are required to report can be found in the IPHC logbook, but some data points recorded in the IPHC logbook may not match the observer program definitions for haul data described in the manual. Use this IPHC data only if the vessel does not provide you with data as defined in the manual and you cannot independently collect fishing information. Information collected from the IPHC logbook must be verified like all other catch data (see Figure 7-5).

ESTIMATING DISCARDS

Observers must make an independent estimate of discards for all sampled hauls. By recording discard estimates in a separate field in the data, fisheries managers are able to quantify discards at both the vessel and fleet level. The time spent on this information should be minimal.

The process of estimating total discards differs between catcher vessels and catcher processors. Regardless of the vessel type, obtaining a discard estimate should only take a few moments. On catcher vessels, discards are

IPHC HALIBUT LOGBOOK Example

Complete this box for each page → TRIP# 2 PAGE: 1 of 1 VESSEL NAME: FLÉTAN STATE VESSEL#: 12345

Complete these boxes once for each trip

| | | | |
|--|--|---|--|
| Captain's IFQ#: <u>1234</u> Captain's Name: <u>JOHN JONES</u> Crew Size (including Captain): <u>3</u> <input checked="" type="checkbox"/> If extra names as above | | GEAR ID: <u>A</u> GEAR TYPE: <input checked="" type="checkbox"/> JAWL <input type="checkbox"/> TRIPLE <input type="checkbox"/> LAMPREY <input type="checkbox"/> SCUM <input type="checkbox"/> TRAIL <input type="checkbox"/> LAND LINE LENGTH OF SKATE (ft): <u>900</u> HOOK Size: <u>3</u> Spacing (ft): <u>9</u> No. Per Skate: <u>100</u> HOOK Size: <u>4</u> Spacing (ft): <u>3</u> No. Per Skate: <u>300</u> | IPHC Initials/#: _____ Date: _____ Sample Number: _____ AREA 4 CLEARANCE NUMBER TO FISH: <u>2013-0084</u> TO OFFLOAD: <u>2013-0147</u> |
| IFQ# <u>1235</u> Name: _____ IFQ# <u>2345</u> Name: <u>MARY JONES</u> IFQ# _____ Name: _____ CDQ (check one) Yes <input type="checkbox"/> No <input checked="" type="checkbox"/> CDQ#: _____ | | | |

RECORD BY STRING (Beginning and End) SWIVELS (check one) Yes No

| CATCH DATE | TIME SEV. HAULED | LOCATION | | | | Beg/End DEPTH (Fath.) | IPHC-Office Use Only | GEAR ID | NUMBER OF SKATES | | TARGET SPECIES | LEGAL-SIZED HALIBUT CATCH | SABLEFISH SOLID FISH SET NUMBER | SABLEFISH WESTERN CUT (IPHC use) |
|------------|------------------|------------|-------------|-----------|-------------|-----------------------|----------------------|---------|------------------|--------------------|----------------|---------------------------|---------------------------------|----------------------------------|
| | | Lat Long | Lon 1 | Lon 2 | Lon 2 | | | | Set | Lost (same hook #) | | | | |
| 5 | 11 | 50°30.40' | 179°56.21'E | 50°32.55' | 179°55.24'E | 40-50 | | A | 12.5 | 1.5 | hal | 6020 | | 0 |
| 5 | 11 | 50°31.76' | 179°55.81'E | 50°32.63' | 179°55.48'E | 115-139 | | A | 20 | 0 | hal | 10840 | | 0 |
| 5 | 12 | 50°30.22' | 179°53.19'W | 50°33.47' | 179°52.93'W | 209-220 | | B | 10 | 0 | BC | 850 | | 4200 |
| 5 | 12 | 50°29.10' | 179°55.73'W | 50°32.18' | 179°55.46'W | 220-282 | | B | 10 | 0 | BC | 1200 | | 3950 |
| 5 | 13 | no fishing | | | | | | | | | | | | |
| 5 | 14 | 50°32.39' | 179°56.03'E | 50°31.51' | 179°58.86'E | 58-90 | | A | 12 | 0 | hal | 7550 | 150 | 0 |

| Date of Sale | Dealer | Dealer Code | Unloading Port | Port Code | Weight Sold | Clear | % | % |
|--------------|---------------------|-------------|----------------|-----------|-------------|-------|---|---|
| 5 16 | Island Cold Storage | | Adak | | 2,654.3 | SS | | |
| | | | | | | SN | | |

IPHC will forward AK Sablefish information to Sablefish Assessment, Alaska Bay Lab

COMMENTS: _____
Capt. signature

Data points recorded in the IPHC logbook may not match the VHF definitions for haul data described in the manual. Use this IPHC data only if the vessel does not provide you with data as defined in the manual and you are not able to independently collect fishing information. Information collected from the IPHC logbook must be verified.

Figure 7-5: IPHC Logbook

generated on deck, where you can see all the fish at one time. On catcher processors, discard can occur on deck or anywhere in the factory.

Familiarizing yourself with the flow of fish on the vessel will help you to recognize areas of potential discard. If vessel personnel sort out and discard undesirable fish, or if portions of the catch are dumped overboard, you must estimate the total weight of these discards. Account for catch discarded in one of the following ways:

1. Using visual cues such as how many baskets of discards a sample generated can help you to quantify what you are seeing. For example, if one of your samples resulted in an estimated two baskets of discards (approximately 80 kg), and that sample represents 1/9th of the entire haul, you can assume there were about 18 baskets of total discards for the haul, or about 720 kg (80 kg x 9).
2. A simple visual estimate based on your observations may be easiest. Experience with method 1 will help you to make more accurate visual estimates. For example, if you estimate that 25% of the catch was discarded then simply multiply the vessel estimate by .25 and enter that weight for discard on the OHF.

Seabird Avoidance Measures

Longline vessels over 55 feet LOA are required to use streamer line seabird deterrent devices to reduce the possibility of catching seabirds. You must independently verify the use of bird deterrents for as many sets as possible. Refer to “Monitoring Seabird Avoidance Measures” on page 16-7 for more information.

You are encouraged to notify the captain if you observe short-tailed albatross, spectacled eiders, or Steller’s eiders around the vessel. Based on this information, the captain may decide to take alternative or extra measures to reduce the likelihood of interacting with these species. For information on observer duties in regards to seabirds, see “SEABIRD INTERACTIONS” on page 16-1.

VERIFYING GEAR

Resource managers calculate catch weights for longliners from the numbers you supply for sample weight, sampled segments, and total segments. Successful management of the longline fisheries is dependent on the accuracy of these values. *It is crucial that the vessel’s gear be independently verified by you!* There are two gear related elements that you must verify: 1) number of hooks per segment, and 2) number of segments per set. See “Snap gear” on page 7-23 for snap gear verification protocol.

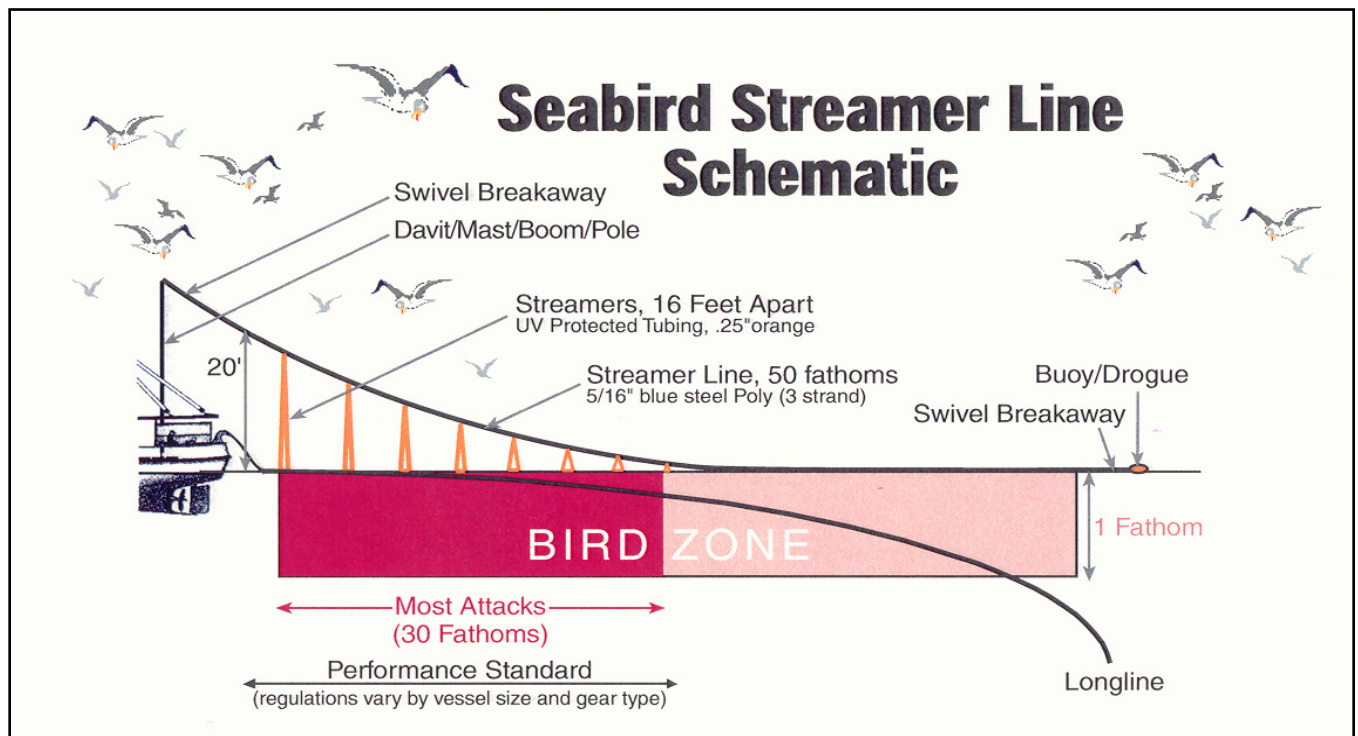

Figure 7-6: Seabird Steamer Line Schematic

In the following sections, methods for obtaining verified values for hooks per segment and segments per set are discussed.

Hook and Segment Data

The total number of hooks per sample and per set are calculated by the database using the data you submit. These data include your independent hook counts per segment and gear verification observations. In rare cases when a vessel is fishing two different sized segments of gear in the same set, you will have to calculate total number of hooks per set. (See “Accounting for Mixed Gear” on page 7-13). Guidelines for obtaining hook counts are below.

The species composition data you supply to the Observer Program are extrapolated to the entire set by relating total segments sampled to hooks per segment data provided to NMFS by the bi-weekly hook count form. Accurate values for segments sampled, total segments in the set, and hook counts, are necessary to determine the total weight of fish harvested!

Counting Hooks

One of the first tasks you need to complete when assigned to a longliner is determine how many hooks are on an average segment of gear. The process of obtaining this information is referred to as getting your “hook counts.” These hook counts must be documented on Deck Forms as they are raw data. These data will then be transferred to the Hook Count and Spacing Form. *Hook counts are the foundation of all your other data. Without these numbers, the total number of hooks in your sample and the number of hooks in the entire set cannot be calculated!*



You must count at least 1/5 the segments, of a typical sized set of gear, at least twice per week.

Determining Average Hooks Per Segment

The captain will record a number of hooks per segment in his vessel logbook, *but you must collect hook count data independently.* The captain’s estimate often reflects the number of hooks when the gear was first constructed, not the current number. As gear is used, hooks are lost and gear is spliced. Though the crew does try to keep segments relatively similar in length, and replace hooks regularly, used gear will almost always have a hook count that differs from when it was new. *As gear is repaired*

over the course of a season, hooks per segment will tend to change. To account for this, hook counts must be performed on a regular basis.

Methods of Obtaining Hook Counts

You must count the number of hooks attached to segments of gear for at least *one-fifth of an average set, twice per week*, the entire time you are aboard the vessel. When you board your vessel, verify with the captain what the average size set will be. This information will help you determine what 1/5 of an average set is and how many segments you will need to include in your bi-weekly hook count collection. When determining how many segments of gear to count you must always round up to the nearest whole segment. In these instances, you may be required to count more than 1/5 of the average set. Your approach to counting hooks will depend on how the vessel is storing gear, therefore, randomization is not required when selecting which segments will be used for hook counts. Methods for obtaining hook counts are discussed below. Record raw data for hook counts on your Deck Form and transfer them to the Hook Count and Spacing Form. See “Hook Count and Spacing Form Instructions” on page 7-23.

Total No. of Segments on Board = 60
Average size set = 21 segments
1/5 of 21 segments = 4.2 = 5 whole segments
Always round up to the nearest whole segment
Hook count collection should include hook counts for 5 segments. Reassess how many segments must be counted when the average size set changes!



Do not use the auto baiter counters to verify hook counts. These machines may not be in good repair and the hook counts are not verified.

- **Counting hooks in tubs or on magazine racks:** Many longliners store their gear in tubs, or on “racks” (also called “mags”) prior to setting it. When the gear is in tubs or on



racks, individual hooks are readily accessible and can be easily counted. Count hooks in these configurations when the vessel is in transit or between sets. Always make sure only overhauled, ready-to-set gear is counted. Use a thumb counter to count hooks since the numbers can get very high.

- **Counting hooks on coiled gear:** A few smaller longline vessels still hand coil their gear onto canvas or plastic mats. Hooks are placed to the center of the coil, making it too difficult to get an accurate count. If the vessel is coiling their gear, you will have to count hooks during non-sample times as the gear is retrieved. *Because this gear has not been through the repair process yet, you must count swivels without gangions (if they are using swivel gear), gangions without hooks as well as gangions that still have hooks!*
- **Counting hooks as they come aboard during a non-tally period:** Since hooks come aboard one at a time, you can count them as the gear is retrieved. It is *highly recommended* that you perform this duty during units that you are not doing anything else, to ensure you are getting accurate counts. *Because this gear has not been through the repair process yet, you must count swivels without gangions, gangions without hooks as well as gangions that still have hooks!*
- **Counting hooks as they come aboard during the tally period:** *This option should not be used by inexperienced observers and should not be used on most CPs because the gear is retrieved too quickly for you to obtain an accurate empty hook count!* If the gear is being retrieved slowly (e.g., during Sablefish and halibut fishing), catch diversity is low, and you are experienced in longline sampling, you may find you can perform hook counts during your tally sample by counting empty hooks as well as fish. The sum of the number of organisms you counted plus the number of empty hooks you counted in a segment is the hook count for the segment.



If you are counting hooks as the gear is retrieved, you must count gangions with no hooks as well as those with hooks or swivels. The gear likely had all the hooks when it was deployed!

Documenting Your Hook Count Data on the Hook Count and Spacing Form

All raw hook count data must be recorded on a deck form then transferred to the Hook Count and Spacing Form.

Each individual hook count is recorded in the Hooks Per Segment column, along with a Segment Number. Segment Numbers should be sequential starting with “1” for each collection. Record a unique Collection Number on the Deck Form form for each hook count collection. If the hooks per segment are counted over the course of several days, record them on the paper Hook Count and Spacing Form. *Do not enter hook counts into ATLAS until you have completed a count on 1/5th of the average set and completed these entries on the form.* The date recorded on the form will be the day you completed all of the hook counts for a distinct collection (on 1/5th of a set). Enter the Collection Number that corresponds to the hook count that should be used for that particular haul on the Observer Haul Form. *If your vessel is participating in an IFQ Sablefish or CDQ Sablefish fishery, you must complete the spacing and average spacing columns on the form before submitting.*

Verifying the Number of Segments in a Set

For each longline vessel to which you are deployed, you need to develop a method for verifying the total number of segments retrieved for as many sets as possible, both sampled and non-sampled. Verifying segments in conjunction with average hook counts are important in order to calculate the value for the total number of hooks in an entire set. Make sure to check and verify the “Number of Skates Lost” column in the vessel logbook and to subtract any lost gear in the “# of Segments in Set” column in the OHF. If you notice any discrepancies between your verified total segments in a set and what the captain is reporting in the vessel logbook, consult the captain to see if there has been some miscommunication. Errors do occur in longline vessel logbooks, so do not assume what you verified is incorrect. Document all discrepancies and resolutions in your logbook, and notify your inseason advisor. Gear deployment strategies and methods used by captains to log the number of segments in a set can be quite different. You must communicate with the captain to determine how he/she is documenting segments per set, and then develop a method to independently verify this information.

Longline Gear Verification Methods

Verification methods will be dependent on vessel activities such as how fast they set or retrieve gear, the number of segments in a set, and the time and effort you have to complete your assigned tasks aboard the longline vessel. Use the guidelines below to choose the most appropriate method to verify gear. It should be noted that these methods are guidelines and can be used interchangeably. Regardless of which method you use, document how you independently verified segments in your daily notes. If you find none of the suggestions work for you, document the situation(s) in your logbook and notify your inseason advisor or Observer Program staff.



Keep in mind that on the Observer Haul Form you need to report the amount of gear retrieved. Document the amount of segments set minus segments lost as the value for Total Segments in Set.

Count segments before and after the set is deployed

On catcher vessels and some CPs, gear segments are stored in plastic tubs or coiled on canvas mats. If the vessel is using tubs, you can verify the amount of gear on board by: 1) counting the tubs prior to each set, then 2) after each set, determining how many tubs remain. Subtract this remaining number from the total number counted to get the amount of gear in the set. If the crew coils their gear onto mats, they will typically keep mats from a single haul together in a stack at the combi station. This way, they are readily available for the crew member who is coiling the gear as it is retrieved. To verify the number of segments in these situations, simply count the mats in the stack and confirm that they are all used at the end of the set.

On most CPs and some catcher vessels, gear is stored on metal racks, with several segments of gear attached to one another. These grouped segments are often referred to as rails or magazines (made up of skates of gear). Some vessels refer to the rail or magazine as a skate. Be sure to become familiar with the vessel's gear and what the crew is referring to when describing gear as all vessels vary. *Ask the crew how many segments typically compose a full rack of gear and how these grouped segments are distinguished from one another.* Every vessel differs in its techniques. Count the total number of magazines or rails before the gear is set, and then again after each set. Subtract the post-set number from the pre-set number to obtain the amount of gear set. It is a good idea to

confirm that the number of segments in each magazine or rail is consistent, so make sure to randomly spot check the number of segments in some racks of gear. You may also be able to confirm segments per mag when you are tallying.

Count all segments on board before and after a set is retrieved

On some vessels it may be possible to easily access the gear on board at any given time. The gear on board may be stored in a gear shack. To verify segments with this method count the gear before and after they are done retrieving a set. Subtract the pre-set number from the post-set number to obtain the amount of gear set.

Using time and the captain's plotter

Counting the number of segments on the captain's plotter in conjunction with time can be an effective way to verify gear for boats that deploy large sets. For example, if a vessel typically takes 10 minutes to haul a segment of gear and you count 48 segments of gear on the plotter, it should take the vessel approximately 8 hours to retrieve the set. Cross check the times and the number of segments recorded in the vessel logbook to see if it matches up with your calculations/observations.

Count segments as it is being deployed

You may be able to count the segments of gear as they are being deployed, if you are present during this process and the gear is not being set too fast. Generally, this method can be done on vessels that deploy small sets with fewer segments.

Count gear as it is retrieved

For vessels that use smaller sets with fewer segments, it may be possible to count the gear as it is being retrieved. You can only use this method if it does not interfere with your sampling duties. On many CP vessels, this method is not feasible because the retrieval of gear may take an entire day or you may not be able to see the gear during the non-tally period.

You can also use your spatial design to verify segments in a set. When using a spatial design, you must be able to sample randomly chosen segments within a set. This can be accomplished by keeping track of the number of segments retrieved via the plotter, working closely with the captain/crew, and by counting the segments retrieved

in the gear room. Through these various methods, you will be able to verify how much gear was set.

Partial Segments

The definition of a partial segment is when the longline vessel is retrieving gear, the line parts or is cut, and only a portion of a segment has been retrieved. In cases where only a partial segment is retrieved, you will need to determine the number of hooks retrieved from the parted longline segment. You may accomplish this by counting the hooks on the retrieved gear segment in the gear room. You will then be able to determine how much of the broken segment was sampled by taking the hooks retrieved and dividing this number by the average number of hooks.

$$\frac{\text{Total Hooks Retrieved From Broken Segment}}{\text{Average Hooks Per Segment}} = \text{Portion of Segment Retrieved}$$

Add the fractional segment to the total whole segments tallied and record this as your sample size.

$$\text{Portion of Segment Retrieved During Sample} + \text{\# of Whole Segments Retrieved During Sample} = \text{Total \# of Segments in Sample}$$

The same process can be used to determine the number of segments hauled if the vessel parts gear and the gear is lost.

$$\text{Portion of Segment Retrieved} + \text{\# of Whole Segments Retrieved} = \text{Total \# of Segments in Set}$$

Document these calculations in your logbook.

If a partial segment is lost and you are not able to verify the number of hooks retrieved, ask the captain/crew for an estimate of the gear retrieved and include this on the OHF “ # of Segments in Set.” *For your species composition sample, it is preferred that you obtain an actual count of the hooks retrieved and use this for your segments retrieved calculation.* However, if you cannot count the actual hooks retrieved, use an estimate of the amount of the segment retrieved for your species composition sample. Document in your logbook and on the Deck Form the reasons why an actual number

of hooks could not be obtained for the calculation of number of segments sampled.

If the gear parts and the vessel is able to retrieve the gear by either picking it up by the end buoys or dragging for it, and no gear is lost, then it is not necessary for you to calculate partial segments.

Accounting for Mixed Gear

There are some vessels that carry different sized segments of gear with a large difference in the average number of hooks per segment. Typically these vessels have only two different sized segments (e.g., half of the gear will have 150 hooks per segment and half of the gear will have 250 hooks per segment). The large difference in the number of hooks between these segments means that two distinct hook counts for each size must be collected and recorded each week (see “Hook Count and Spacing Form for a Catcher Vessel” on page 7-31).

Talk to the captain to determine if the vessel is using different sized segments of gear and if they intend to mix them within the same set. Let the captain know that you need to account for the different segment sizes in your haul data. If the two different sized segments are set together you must maintain a count of segments of each size and calculate the total hooks retrieved for each haul, regardless of how many of each size segment are mixed. Work with the vessel to identify the different sized segments in the set and during your sampling. Document all instances when gear is mixed. The collection number recorded on the OHF should be the number that represents the majority of the gear in the set. In your logbook, document your calculations for the average hook count per gear type and the number of segments of each type that were within your samples and in the entire set. Record the total hooks on the OHF. The methods for calculating and recording the use of mixed gear are below.

Different Sized Magazines or Rails

There are several longline vessels that have the same type of gear, but the gear is composed of a different number of segments. On these vessels, the segment size does not vary, but the magazine or rail will be composed of a different number of segments. For example, half of the vessels gear may be made up of 4 segment magazines and the other half will be made up of 6 segment magazines. You may either be able to track these long and short

magazines of gear or keep an accurate count of the total segments. On these vessels, the captain may record the gear being hauled by the total number of skates. To avoid having to calculate total hooks in your sample or haul, set up your design to sample by skates. If you are able to track individual skates of gear and sample based on skates, long and short magazines do not need to be tracked. Perform your twice weekly hook counts based on skates, and count 1/5th of an average set of skates.

If you are sampling by long and short magazines or rails you must mark the different sized segments and record the data as you would for mixed halibut and Sablefish gear.

If you cannot track individual skates, ask the crew if they have gear with an extra skate attached. You must track this gear. You should have the vessel mark it with a splice of colored line. It is important that the “long” mag (as it may be referred to) is accounted for during your species composition samples, and those extra hooks are accounted for on the Observer Haul Form

Hook Configuration on Halibut Gear vs. Sablefish Gear

Halibut gear has a slightly different configuration than Sablefish gear. The gangions on halibut gear are typically farther apart, so there are fewer hooks than on an equal length segment of Sablefish gear.



If the vessel has a Pacific Halibut IFQ permit, the captain may fish two different kinds of longline gear (halibut and Sablefish gear) with differing numbers of hooks per gear segment in a single set.

If you are on a vessel fishing for both Sablefish and halibut, talk with the captain and examine the gear to determine if some of the gear is different, and/or different gear is mixed within a set. The average number of hooks per segment and number of gear segments of each gear type contained within the set must be determined. Document instances when gear is mixed. Also document your calculations for the average hook count per gear type, and the number of segments of each type that were within your samples and in the entire set. This information will be necessary if your data needs to be corrected later.

On your OHF, record the total segments for the set and the total hooks for the set. Make sure that your total hook count represents the correct combination of halibut and

Sablefish segments in the set. Refer to the following discussion on obtaining hook counts and determining average hook counts by gear type.

Calculating an Average Hook Count- Mixed Gear

Determining an average hook count is simple:

1. Count hooks on a known number of segments.
2. Divide the total number of hooks counted by the total number of segments assessed. The resulting value represents the average hook count of a segment within the set.
3. Record the average hook count full field for your calculations.

$$\frac{\sum \text{number of hooks counted in each segment}}{\text{number of gear segments counted}} = \text{average hook count}$$

Calculating Total Hooks in the Set

Calculating total hooks in a set must only be done when your vessel is using mixed gear.

Once you have a value for average hooks per segment per gear type and total segments per set of each gear type, you can calculate the total number of hooks for the entire set. Do not round your hook counts until you have performed the final calculation to come up with your total number of hooks. Record the total number of hooks on the OHF as a whole number.

$$\text{average hook count} \times \text{total \# segments in set} = \text{Total hooks in set}$$

If the vessel is fishing mixed gear for halibut and Sablefish, you will need to determine a separate average hook count for the two types of gear. You will also need to determine how many segments of each type are in the set. Apply the average hook count value for the halibut gear to the number of segments of halibut gear in the set and apply the average hook count for the Sablefish gear to the number of segments of Sablefish gear in the set. *Combine these two values for the total hook count in the set.* On the OHF form, record this total hook count along with the collection number and number of segments in

the set. The presence of the total hook count will override the entry for the number of segments and the collection number.

Calculating Total Hooks in Your Sample

Average hook counts are also used to determine sampled hooks. *Calculating total hooks in your sample must only be done when your vessel is using mixed gear.* Simply multiply the number of gear segments sampled for composition by your average hook count to determine the number of hooks sampled.

| |
|--|
| $\text{average hook count} \times \text{total \# segments sampled} = \text{total hooks in sample}$ |
|--|

Enter this information on the Deck Form in the “# of Sampled Hooks” field. If the vessel is fishing mixed gear for halibut and Sablefish, you will need to determine how many segments of each gear type are in your sample and apply the average hook count you calculated for each gear type. Apply the hook count value for the halibut gear to the number of segments of halibut gear in the sample and apply the hook count for the Sablefish gear to the number of segments of Sablefish gear in the sample. Combine these two values to get your sample hook count.

The calculations for average hooks per segment, total number of hooks in the set, and total number of hooks in your sample must be documented in your logbook.

HOOK SPACING

Hook Spacing measurements must be completed in all Sablefish IFQ and Sablefish CDQ fisheries that do not fish using snap gear (as spacing is too variable on snap gear).

Catch rate (the amount of catch per hook) is a value computed from catch data and effort data. Hook spacing is required in order to standardize effort data because catch per hook is higher for wider hook spacings; hook spacing experiments show that the catch per hook for 4 meter spacing is twice that for 1 meter spacing. Hook spacing is essential for computing catch rate information for hook and line gear used in the Sablefish fishery.

Hook spacing data must be collected from the same segments used for hook counts. If you are having

problems collecting these data due to the vessel’s set up, contact NMFS staff for advice.

How to measure

Measure the distance between gangions. Due to limited space on fishing vessels, it is recommended that you pull the line up out of a longline tub while at the same time holding the measuring tape alongside the line. Measure the length between where the gangions are attached to the mainline. This method is faster than laying the groundline out flat and measuring it (see Figure 7-7).

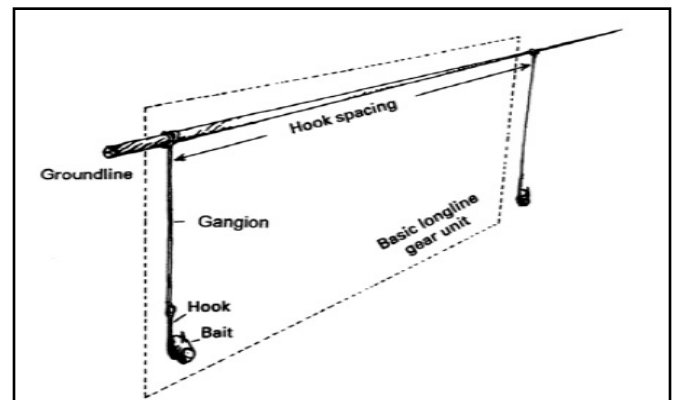

Figure 7-7: Hook Spacing

Collection Procedures:

1. Complete measurements once for each vessel, with the exception being if they make changes to the gear while fishing. In this scenario, please repeat the measurements. Measure the hook spacing while the baiters are hand-baiting or while the longline gear are in tubs, skate bottoms, or on racks.
2. From a single longline set, randomly select 5 separate segments from which to take measurements. From each of the 5 segments, measure the distance (in cm) between six consecutive hooks (see Figure 7-7 on page 7-15). You should measure hooks from parts of the line which have not been patched. When you complete all 5 segments, you will have a total of 25 measurements.
3. Hook spacing data is directly associated to the segments used for hook counts. If 1/5th of an average set is less than five segments of gear and a hook spacing collection is needed, you still need to count and measure a total of five segments of gear. In this case, count an extra segment or two to meet the 5 segment requirement.

- Record the measurement in centimeters per hook interval on the Hook Count and Spacing Form.

OFFLOAD DATA FOR LONGLINERS

Observers on catcher longliner vessels must report offload information on the Vessel/Plant Offload Form. Data for the Vessel/Plant Offload Form may be obtained from the Alaska Department of Fish and Game (ADF&G) fish ticket.

Determining Offload Delivery Weight

When the vessel delivers its catch to a processing plant, the fish are weighed. The scales at each plant are tested by the State of Alaska annually and they do not need to be tested daily in order for you to use this weight as a delivery weight. The weight of everything delivered is totaled and provided to the vessel on the Alaska Department of Fish and Game (ADF&G) fish ticket. Catcher vessel observers will record delivery information on the Offload Form (see page 7-17 for Offload Form instructions).

In the majority of situations, the fish ticket will be the best source of data for determining delivery weight. Plants are allowed to record the number only of prohibited species for some deliveries, however fisheries managers need weight data as well. If you are using the fish ticket for a delivery weight, the total round weight will be documented in the "Observer Only" box at the bottom of the fish ticket (see Figure 4-11 on page 4-27) in Trawl Catch. This weight should include everything that was delivered to the plant. If the total round weight on the fish ticket is incorrect, make the appropriate changes and document the situation in your logbook. For information on interpreting fish tickets and tips on how to avoid potential errors see Figure 11-2 on page 11-18. *Though they may appear on the fish ticket, at-sea discards are never included in your delivery weight.*

Obtaining Your Fish Ticket

Work with the plant observer and/or plant personnel to obtain the fish ticket information for your delivery. It will be expected that you try to obtain a fish ticket prior to leaving port. Fish tickets can be obtained from the processing facility where your delivery occurred or from Observer Program staff in a field office or Seattle. Check with the plant office to find out when you can expect the fish ticket (i.e. landing report) to be ready. There is usually a 2-3 day wait for the plant office to

issue a fish ticket. It is not uncommon that you will leave port before it is ready and will have to obtain the ticket from an Observer Program office or from the plant after your next delivery. At the first opportunity you must obtain your fish ticket and submit your completed plant/vessel offload information to NMFS. Fish tickets contain confidential data, and must be secured at all times. It is expected that no one but you see this fish ticket or have access to it.

Landing Report Verification

Delivery weight information must be verified. The delivery weight information may be verified by a plant observer. Plant observers, if present, need to give you documentation on how verification was done when they complete this task. For more information on this aspect of a plant observer's duties see "Delivery Worksheet Verification" on page 11-8.



You must verify the delivery information before you record it on the Plant/Vessel Offload Form. You are responsible for knowing and documenting how all your data were derived!

You are responsible for your data and must know how delivery information were derived. If no plant observer is assigned to the plant you deliver to, CV observers must document the delivery methods. Verifying delivery methods requires documenting how fish were offloaded (pumped or by hand) and how they were weighed (hopper scale, brailer, totes, etc.).

Catcher vessel observers must be able to provide details about their offload and the accuracy of the landing report, including verification of the following:

- Do the species reported on the landing report match your observations of catch at sea and the offload?
- Are the delivery weights correct? Was the correct product recovery (PRR) code applied to fish that were bled or processed at sea?
- Is the condition of fish delivered properly reported on the Landing Report? For example, if fish were bled at sea are they reported on the fish ticket as bled fish?
- Was ice/slime deducted, if so was it significant and was this correctly accounted for?
- Are discards at sea reported on the Fish Ticket?
- Are there reported fish with the product code of 92, 95,

or 97? If these fish were weighed at the plant you must add their weight to the “Total Round Weight” value reported on the landing report. If these fish were not weighed they should be added to the discards for the appropriate haul on the OHF. If you are unsure which haul the discards were from, allocate all discards to the largest haul.

Document any discrepancies between the landing report information and what you may have observed at sea or during your offload. For more information on reading your landing report see “ADF&G Electronic Groundfish Ticket Instructions” on page 11-18.

Partial Coverage Sector Offload Verification

Observers deployed in the partial coverage sector must also verify that an offload occurred. If you are not staying on the vessel you need to communicate to the captain that you must be notified when the offload begins or given the offload start time so that you have the opportunity to go to the plant and verify the offload is taking place.

Offload Form Instructions

Complete the Offload Form for all catcher vessel deliveries. You must maintain a set of Offload paper forms in addition to sending these data electronically. *Refer to “Offload Data Form” on page 2-24 for instructions on how to enter this data into ATLAS.*

Cruise Number, Permit, Year, Observer Name, and Vessel/Plant name: Enter your cruise number. Enter the vessel permit found in the manual on page A-31. For “Year” enter the full year (e.g., “2024”). Enter your name and the name of the vessel to which you are assigned.

Resubmission: Not used for vessels with ATLAS.

Processor Name and Processor Permit: In the box in the upper left hand corner, fill in the name and processor permit for each of the plants to which your vessel delivers. You only need to record each plant once for each data set. There is a list of processor permits for shoreside or floating plants and motherships on page A-29. If your vessel delivers to a plant that is not on the list, enter 99999 (for “unknown”) and contact NMFS staff for advice.

Offload Trip(s) First/Last: Enter the trip numbers for all trips associated with an offload. Record the initial trip

after boarding the vessel to the trip where the offload occurs.

Use these guidelines when completing the “First” and “Last” columns:

- **Offload #1:** You board your vessel, it travels to the fuel dock (trip 1) and then goes fishing (trip 2). You tie up at the dock and offload (end of trip 2). On the offload form “First” trip will be trip 1 and “Last” trip will be trip 2.

The following offloads “first” trip number will be that trip that follows the previous offload.

- **Offload #2:** The vessel moves to the fuel dock (trip 3) then goes fishing (trip 4). You tie up at the dock and offload (end of trip 4). On the offload form “First” trip will be 3 and “Last” trip will be 4.

Record the trip number in both columns if there is only one trip associated with the offload.

- **Offload #3:** The vessel heads back out to fish (trip #5) and returns to deliver (end of trip 5). On the offload form “First” trip will be trip 5 and “Last” trip will be trip 5.

In the event that your vessel offloads its catch to 2 or more processors, record the range of all trips associated with the entire catch, for example:

- **Offload #4 and #5:** The vessel heads back out to fish(trip6). You return and deliver half the catch to Akutan (end of trip 6) and then travel and deliver the rest of its fish to Sand Point (trip 7). For offloads #4 and #5, the “First” trip will be trip 6 and the “Last” trip will be trip 7.

Offload Number: All offloads must be recorded and assigned a number. Offload numbers must be unique for the cruise/vessel and should be sequential and ascending, beginning with “1.”

Completion Date: Enter the month and day the offload was completed. Write the dates in two digit format.

Gear Type and NMFS area: These columns are used by plant observers only. Leave these columns blank.

Total Delivered LB or KG: Record the total round weight delivered to the plant for that trip. Delivery weights can be entered in either pounds or kilograms. Delivery weights recorded in pounds must be recorded to the nearest whole pound. Weights reported in kilograms must be

reported to the nearest whole kilogram. Remember that when cut or bled fish are delivered, the round weight must be used. Round weights are listed at the bottom or end of the fish ticket.

If there are multiple fish tickets with the same Landing Report ID Number, sum the individual delivery weights to obtain a single total delivery weight.

Total Pollock Weight, Were all Groundfish Weighed?, ADF&G Number of Delivering Vessel: These columns are used by plant observers only. Leave these columns blank.

Receiving Processor Permit Number: For each offload, record the processing plant's permit number. The permit numbers should be one of those you listed under Processor Name and Processor Permit Number described above. If a delivery is split and sold to more than one processor, you should make an entry on the Vessel/Plant Offload Form for each delivery. If this, or any other incident out of the ordinary occurs, please note the circumstances in your logbook.

Was Catch Sorted (Y/N): Record a "Y" for any delivery that was sorted at sea. Record an "N" if the crew did not sort the catch before delivery.

Tender offload (Y/N): Record a "Y" if your vessel acted as a tender by receiving catch from another vessel. Otherwise enter an "N."

Landing Report ID Number: Record the Landing Report ID Number associated with the delivery for this vessel. This number will be taken directly from the fish ticket, from a delivery worksheet provided by the plant observer, or may be obtained from the plant office along with other catch information. Record the Landing Report ID Number exactly as it appears on the fish ticket. If you did not receive a fish ticket, this field may be left blank. Multiple fish tickets associated with the same offload to a single processor will usually have the same Landing Report ID Number. In this case, there should be a single line of entry for this delivery.

Occasionally, there may be more than one Landing Report ID Number for an offload. If this occurs, each one must be listed separately on the Offload Form as if they were separate offloads. The trip number will remain the same, but the offload numbers and total delivery weights will be unique to each Landing Report ID Number.

RECORDING VHF AND OHF DATA

All calculations must be recorded in your logbook. Keep accurate, complete records throughout your deployment! This will enable you to provide staff with pertinent cruise details at your debriefing interview. *You are responsible for your work and must be able to recall all methods and techniques used to collect your data.*

Completing Haul Forms on Longline Vessels

In addition to entering data and calculations in the observer logbook, all observers must complete a summary of fishing effort and total catch. This information is recorded on the Vessel Haul and Observer Haul Forms (VHF and OHF). *If you are on a vessel equipped with ATLAS, you must maintain a set of paper forms in addition to sending these data electronically.*

The fishing effort information required on the Vessel Haul Form should come from the vessel's NMFS logbook or electronic logbook if the vessel maintains an NMFS logbook. On vessels under 60 ft, this information will come from one of the alternative methods described on page 7-4 and page 7-8. Additionally, *observers must retain the goldenrod copies of the vessel logbook pages or signed copies of the electronic logbook printouts pertinent to their cruise.* The logbook copies are submitted with all other data for the vessel. For expectations on when you will receive signed copies of the goldenrods or the electronic logbook, see "Record Keeping and Reporting \$679.5" on page 20-13.

When recording information on the VHF, check carefully to ensure that the data are accurate and reasonable and there are no transcription errors. The OHF contains entries for calculated values. Double-check your work! Instructions on how to fill out each of these forms follow.



Keep the "goldenrod" copy or printed copies of the electronic logbook in a secure place. These forms are confidential, and must not be seen by crew from other vessels.

Completing the Vessel Haul Form (VHF)

An entry must be made on the VHF for every day you are assigned to a vessel. This is the Observer Program's only way to account for the number of days you were assigned to a vessel. Start your entries with the day you embark on the vessel and end them on the day you disembark the vessel. A non-fishing day must be recorded for each day gear was not retrieved, such as during a delivery or day in

port. Skip a line between each day's entries. Ensure that all sets retrieved during your deployment are recorded on your VHF, whether you sampled them or not. Sets will be recorded in order of retrieval date and time. Keep separate sets of forms for each vessel to which you are assigned. Refer to Figure 7-9 for an example of a longline Vessel Haul Form.



Longline sets are documented in the order they were retrieved, not the order in which they were set. This means you may have out-of-sequence set numbers. It is OK if your set numbers are out of order because the vessel retrieved gear out of order.

- **Cruise, Permit, Year:** Enter the cruise number supplied in your training or briefing. Enter the vessel permit number found on page A-31. For “Year” enter the full year (e.g., “2024”).
- **Observer name/Vessel name:** Enter your name and the name of the vessel.
- **Trip Number:** Enter the trip number for the set. Trips should be numbered consecutively starting with the number one. Refer to the chapter “TRIP INFORMATION” for more details on documenting trips.
- **Haul Number:** There must be an entry for every set of gear retrieved. Each set should have its own distinct number. You should use the same haul numbers the vessel uses in their logbook. This will make it easier to track the sets and enter the corresponding data on your forms, especially if gear is retrieved out of order. Haul numbers may be out order because sets will be recorded by retrieval date and time. Enter a “0” in this field for all non-fishing day entries.
- **IFQ? Y or N:** Was the particular set fished under an Individual Fishing Quota? Enter an “N” if it was not. Enter a “Y” if it was. An IFQ permit number in the upper left hand corner of the DCPL or DFL and an entry greater than 0.00 in the columns “IFQ Halibut” and/or “IFQ Sablefish” indicate the vessel was fishing IFQ (see page 7-5). For a description of IFQ fishing see page 2-19.
- **CDQ group #:** Record a “C” and the two digit CDQ group number for each set taken using the Community Development Quota (CDQ). This number can be found

at the top of the vessel logbook in the box marked “CDQ group #”.

- **Gear Type:** Enter the appropriate gear code in this column. The Gear Type codes are:
 - 8 -Longline vessels.
 - 7 -Jig vessel.
- **Vessel Type:** Enter the appropriate code.
 - 1 -Catcher Processor (CP) - vessel processed and froze it’s own catch.
 - 3 -Catcher-only Vessel (CV) - vessel has retained fish for delivery to a shore-based plant, a floater or mothership.
 - 5 -All-sold/bait: The vessel used the catch as bait, or sold catch directly to other vessels to use as bait.
 - 6 -CV-discarded: The entire catch from this catcher-only vessel’s haul was discarded and not delivered.
- **Gear Performance:** Enter the appropriate code. This code indicates if there were problems with the gear that may have affected the amount of fish caught. The following codes are applicable to longline fishing.
 - 1 - No problems.
 - 2 - Crab pot(s) inset.
 - 5 - Other problem: describe the problem in your logbook daily notes.
 - 6 - Gear lost (partial or complete loss of gear).
 - 7 - Considerable depredation of the catch by sea lions.
 - 8 -Considerable depredation of the catch by killer whales.
 - 9 - Not used for fixed gear.
 - 10 - Considerable depredation of the catch by sperm whales.

Note in the comments section of the Vessel Haul Form and your Daily Notes the reasons for using gear performance codes other than code 1. See “Feeding on Catch or Discards” on page 14-2 for a description of marine mammal catch depredation. When codes 7, 8, or 10 are used, complete a Marine Mammal Data Form in Atlas as these are examples of “Feeding on Catch (not yet landed)” (see page 14-5).

- **Location Code:** Enter “R” if the location is a retrieval position. Enter a “D” if you are on a mothership receiving catch and are unable to obtain a retrieval position (not common for longline vessels). Enter “N” for each day you are assigned to the vessel that no gear is retrieved (see “Non-Fishing Days” below). There must be a position entry for every day you were on board the vessel.

- **Purpose Code:** The Purpose Code provides a label in your data signifying how the data will be used for fisheries management. Enter the following code unless otherwise instructed by Observer Program Staff:

CA - Catch Accounting

Non-Fishing Days

A non-fishing day is one during which you are assigned to a vessel and no hauls are retrieved. All days while assigned to a vessel, including days in port, steaming, or waiting out a storm, must be accounted for. The trip number will be blank for all non-fishing days. Enter “0” in the haul number column, and a location code of “N”. Record the Month/Day and latitude/longitude of the vessel for that day under the “*Retrieval Information*” Tab. *Do not include a time.* Non-fishing days are recorded on both the VHF and the OHF.

Port Coordinates

If you are in one of the ports listed in the appendix “Port Codes and Non-Fishing Day Port Positions” on page A-27 on a non-fishing day, you can use the coordinates given as the non-fishing day position. One hundred degrees of longitude are assumed, so do not enter the leading “1”.

“Deployment Information” Tab

- **Month/Day:** Enter the date the first hook of a set was deployed. The month and day must be two digits (e.g., 01/01 for January 1st).

- **Time:** Enter the time the first hook of a set entered the water. Verify that the captain is entering this time, not the time the anchor or flag entered the water. All entries must be in Alaska Local Time (ALT). Enter four digits with no colon marks.

- **Latitude:** Enter the vessel’s latitude when each set’s first hook was deployed. This position can be found in the “Begin Position” field in the vessel logbook. Vessels

may record their positions to the nearest minute, seconds, or hundredths of a minute. If the vessel listed their positions to the hundredths of a minute, you must convert this value to seconds. To convert from a hundredth of a minute (also called a decimal minute) to seconds, use the “Decimal Minutes to Seconds Conversion Chart” on page A-45. If you need to do the calculation, use the formula “Abbreviations, Conversions, and Formulas” on page A-19. Do not enter degree marks or include an “N” to indicate north for latitude. Degree, minute, and second entries must be two digits.

- **E or W:** Fill out the “E or W” column to indicate if the longitude is east or west of the 180-degree line.

- **Longitude:** Enter the vessel’s longitude when each set’s first hook was deployed. This position can be found in the “Begin Position” field in the vessel logbook. One hundred degrees of longitude are assumed, so do not enter the leading “1”. Record the position to the same level of accuracy as it is recorded in the vessel logbook. Vessels may record their positions to the nearest minute, seconds, or hundredths of a minute. If the vessel listed their positions to the hundredths of a minute, you must convert this value to seconds. To convert from a hundredth of a minute (also called a decimal minute) to seconds, use the “Decimal Minutes to Seconds Conversion Chart”. If you need to do the calculation, use the formula “Abbreviations, Conversions, and Formulas” on page A-19. Do not enter degree marks. Degree, minute, and second entries must be two digits.

If the vessel is not recording seconds or a hundredth of seconds, leave this field blank. Coordinates with minutes greater than 59 are not valid. Enter only numbers in the latitude and longitude columns. Do not enter any marks or slashes to indicate degrees, minutes, or seconds. Degree, minute, and second entries must be two digits.

- **Average Bottom Depth:** Average the beginning and ending depths found in the vessel logbook. Round the depth to the nearest whole number. Do not enter decimals in this field.

- **Average Gear Depth:** Leave this column blank.

- **M or F:** Record “M” if depth is reported in meters, Record “F” if depth is reported in fathoms.

“Retrieval Information” Tab

- **Month and Day:** Enter the date the last hook of a set is retrieved. Month and day must both be two digits (e.g., 01/01 for January 1st). Attribute the set to the day retrieval is completed (i.e., record sets in order of retrieval date).
- **Time:** Enter the time the last hook was retrieved. You can find this time in the “Time Hauled” field in the vessel logbook. All entries must be in Alaska Local Time (ALT). Enter four digits with no colons.
- **Latitude and Longitude:** Enter the latitude and longitude of the vessel when the last hook of the set was retrieved. This position can be found in the “End Position” field of the vessel logbook. Follow the same rules as described for deployment.

Completing the Observer Haul Form (OHF)

An entry must be made on the OHF for every set made by the vessel, whether it was sampled or not. Follow the same guidelines as for the VHF. Include the same spacing and “0’s” for non-fishing days. *Skip a line between each day’s entries.* When placed side-by-side, you should be able to read the VHF and OHF forms straight across all rows. The information for a haul on one form should line up with the same haul’s information on the other form. Always start a new OHF when you start a new VHF. Keep a separate set of data forms for each vessel to which you are assigned. Refer to Figure 7-9 for an example of a longline Observer Haul Form.

Cruise, Permit, Year: Enter the cruise number supplied in your training or briefing. Enter the Vessel permit numbers found on page A-31. For “Year” enter the full year (e.g., “2024”).

Observer’s Name/Vessel Name: Enter your name and the name of the vessel.

Full Name of Catcher Boat box Catcher Boat’s ADF&G#: Fill in these two items only if you are on a mothership. Longline motherships are rare in the Alaskan fisheries.

Haul No.: The set number must correspond with the set number on the VHF and all other data forms. If a line is skipped on the VHF, skip the same line on the OHF. Non-fishing day entries must match the VHF with a haul number of 0.

Electronic logbooks will not allow duplicate haul numbers during a calendar year. If possible you should use the same numbering system as your vessel if they are using an electronic logbook. If you are unable to use the same numbering system let your inseason advisor or Observer Program staff know the reason why.

Haul Sampled By?: Enter the cruise number of the observer who sampled this haul for species composition. Always enter “0” if there are no species composition data collected for a haul or in the event that all composition data has to be deleted. If more than one observer samples a haul record the cruise number of the observer who sampled the majority of the haul.



If working with another observer, divide the sets that you both sampled evenly between you. Document your system of assigning shared sets in your logbook.

RST On Haul?: Enter one of the appropriate letter codes:

- Y - I used the RST and it was an “ON” haul.
- N - I used the RST and it was an “OFF” haul.
- X - RST is not being used, all hauls were sampled, or using RBT only.

RBT on Break?: Enter the code as to whether or not you were using the Random Break Table.

- Y - I am on a break.
- N - I am not on a break. If you are not using the RBT, this is your default code.

Sample Design: Enter the code that best describes your method used for collecting your composition samples. Leave this field blank for unsampled hauls. See “Sample Designs for Species Composition” on page 2-25 in Essential Information for a description of each code:

- 5 - Opportunistic
- 6 - Simple Random
- 7 - Systematic Random
- 9 - Other Random
- 10 - Census
- 11 - Other
- 12 - Unknown

Sample Unit Type: Enter the code that best describes the sample unit used for completing your composition sample. Leave this field blank for unsampled hauls. See “How to Use the Random Number Table” on page 2-26 for a description of each unit type:

- 1 - Gear
- 2 -Time
- 5 - Other
- 6 - Unknown

% Monitored for Marine Mammals: This is the percent of the gear you monitored for the presence of marine mammals. This is normally the percent of the gear that was tallied but *may include more if you also watched the gear at other times*. Divide the number of segments of gear you watched being retrieved by the total segments of gear in the set, or divide the total time you watched gear being retrieved by the total retrieval time of the set. Multiply this number by 100, round it to the nearest whole percent, and enter it into the percent Monitored for Marine Mammals column.



You may include unsampled gear as monitored for marine mammals as long as you were near enough to the line to ensure that you could have seen any mammal interactions or depredated catch.

Gear Descriptor: On vessels using longline gear, leave this column blank.

Fishing Method: On vessels using longline gear, leave this column blank.

Vessel’s Total Catch Estimate (mt): Record the “Hail Weight” from the vessel logbook. If the vessel is not required to keep a logbook, you must obtain the vessel estimate from the captain. If the estimate is in pounds, convert the estimate to metric tons and round to the nearest two decimal places. Show this calculation in the observer logbook. There must be an entry for every haul. This value should be recorded directly from the vessel logbook.

Estimated Discard Weight (kg): Record the estimated discard weight in kilograms, rounded to the nearest whole kilogram. If there were no discards, enter a zero value in the discards column for that haul. If you do not know whether or not there were discards or it was an unsampled haul, leave the field blank.

Trawl Vessels Tab: The information in this tab is for trawlers only; leave these columns blank.

“Longline and Pot Vessels” Tab

Hook Collection #: Enter the hook collection number that corresponds to each haul. Follow the rule of retrieval. As soon as a hook count is completed, assign that hook collection to the next retrieved haul, and any other hauls that follow until a new hook collection is completed. If your vessel is using mixed gear, the collection number recorded on the OHF should be the number that represents the majority of the gear in the set.

of Segments in Set: Enter the total number of segments of gear in the set. Record only the amount of gear that was retrieved. *Do not include gear that has been lost in your value for total segments in a set.* The amount of gear set and lost is recorded in the vessel’s log in the “Number of Skates or Pots” columns. What captains consider to be a “segment” differs between vessels. The captain may be counting skates, mags, tubs, or coils of gear, any of which you may designate as a segment of gear. Remain consistent with what you designate as a segment of gear for the entire time you are on the vessel. *Partial segments of gear should be recorded as the number of segments to two decimal places, not as the number of actual hooks. For example, “15.25” is an acceptable entry to the # of Segments in Set field.* See “Partial Segments” on page 7-11.

Total Hooks in Set: *Leave this field empty unless you are on a vessel that is setting two different-sized segments of gear (mixed gear) within the same string or if your vessel is using snap gear.* Enter the total number of hooks in the set. Total Hooks must be rounded to a whole number, and there must be an entry for every set when mixed gear is used. Record only the number of hooks that were retrieved. *Do not include hooks from segments that have been lost.* If you enter a value in the *Total Hooks in Set field*, the number of segments remains a required entry on the Observer Haul Form.

Flow Scale Weight (MT): Record the flow scale weight in metric tons directly from the electronic logbook. This is the weight of all Pacific Cod weighed by the flow scale. Always record the flow scale weight as it is entered in the vessel’s ELB. No changes should be made based on your observations. If a potential error is identified, notify the captain, clearly document the situation in your daily notes and contact your inseason adviser.

Bird Deterrence Code: Independently verify the gear setting operations and record the appropriate code for the type of seabird avoidance gear being used. Record an “N” for hauls that you were not able to observe the setting of gear.

- 1 - Paired streamer line used
- 2 - Single streamer line used or one streamer line and one buoy bag
- 3 - Single buoy bag used
- 0 - No streamers were used
- N - Observer didn't check deterrent type

Document any other deterrent methods used in the comments section of the OHF and in your Daily Notes. If the vessel uses one streamer line and one buoy bag together you will use the code for a single streamer and document the deterrent method.

Deterrence code entries must be based on your actual observations not what is recorded in the vessel logbook.

See “Monitoring Seabird Avoidance Measures” on page 16-7, the Streamer Line Schematic on page 7-9, and a summary of Avoidance Regulations on page 20-21.

HOOK COUNT AND SPACING FORM INSTRUCTIONS

(See “Snap Gear Hook Count and Spacing Form Instructions” on page 7-25 for instructions to complete this form for snap gear)

Without accurate information on your Hook Count and Spacing Form, accurate catch estimates cannot be completed. Complete the Hook Count and Spacing Form for all longline vessels. Enter these data to the Hook Count and Spacing Form in ATLAS. Each paper form has room for two complete hook counts. If you need to use both, simply cross out the header information for the lower collection and write “continued” in the collection row.

Cruise/Permit: Enter the cruise number supplied in your training or briefing. Enter the Vessel permit numbers found on page A-31.

Observer Name/Vessel Name: Enter your name and the name of the vessel.

Resubmission: Not used for vessels with ATLAS.

Collection Number: Number used to reference the hook count on the Observer Haul Form. The number must be unique by permit number, starting with collection number 1.

Date: The date entered corresponds to the day you completed your last hook count for this Collection Number.

Segment Number: Enter a Segment Number for each segment on which you counted hooks. The segment number for each individual Collection Number should start with the number one.

Hooks Per Segment: Enter the number of hooks counted on a single segment of gear.

Spacing (cm) and X: Used only when collecting hook spacing data aboard IFQ or CDQ Sablefish vessels. Enter the distance between six consecutive hooks from five individual segments into each column. Calculate the average distance between the hooks and enter that value in the X column. Only the X column value will be entered into ATLAS. See “Hook Spacing” on page 7-15 for instructions on completing this data. Do not do hook spacing on a snap gear vessel.

SNAP GEAR

Snap gear is a type of long line gear where the gangions with baited hooks are “snapped” on to the groundline as the gear is spooled out behind the vessel from a large drum. The hook is attached to a gangion tied to a metal snap. The gangion is typically 12-24 inches long (up to 48 inch long gangions are used when targeting halibut). Groundline is run off the drum during the set and baited hooks are snapped onto the line by crew. During retrieval the snaps are removed as the line comes aboard and the line is re-coiled around the drum. Snap hooks are then stored on the vessel before being re-baited by hand and set. This gear configuration can be challenging to verify as it does not utilize equal sized segments of gear, equal hook spacing, or equal hooks fished per-set.

Snap Gear Hook and Segment Data

On a snap gear vessel the number of segments in a set will always be “1” unless gear is lost. If gear is lost, the number of segments should be listed as a partial segment based on the number of hooks retrieved. If gear is lost, count the # of hooks retrieved and record this number

on the Observer Haul Form as total hooks retrieved. This will only work if you are counting hooks as they are retrieved or if the vessel stores hooks retrieved in a way that they are available for you to count. If you are not able to get a count of the hooks retrieved, obtain an estimate of the hooks retrieved and record this as a partial segment on the Observer Haul Form (see Snap Gear Partial Segments 7-24).

A very small number of snap gear vessels use segmented gear in tubs. Even if a vessel uses segmented snap gear, the number of segments set will still be considered “1” (on the observer Haul Form) because the number of hooks per segment and the segment sizes are too variable to be reported as reliable haul data.

Snap Gear Verification: Counting Hooks

Snap gear is longline gear that has individual hooks “snapped” onto the groundline by hand during the setting of the gear. It may consist of one long continuous piece of groundline or segments that are connected together as the line is set. Because hooks are added as gear is set, the standard methods for obtaining total hook counts for haul and sample size discussed earlier in this section are not possible. The observer will need to verify the total number of hooks per set for every set. Options for obtaining accurate hook counts are below in order of preference:

1. Monitor the setting process and count hooks as the gear is being deployed and the hooks are “snapped” onto the line. This is the preferred method. Keep in mind that poor lighting may present challenges to counting hooks during night time gear deployment or retrieval.
2. Monitor the baiting process and count hooks as they are being baited. You will need to observe the setting of the gear to verify that the vessel is setting the same number of baited hooks. Hooks may be left over, or the crew may bait more hooks during the set to add to the line. Keep in mind that they may choose to bait hooks for multiple sets at once.
3. Monitor the entire retrieval and count hooks as they are retrieved. This may be done for sampled or unsampled hauls. You may sample as a census or you could sample a portion of the set and count the remainder of the hooks. If you are sampling a haul, you must tally empty hooks as well as count everything caught on the line for a total hook count

in the set. Keep in mind that you have other sampling priorities that may not be accomplished if you decide to census a haul. Poor lighting may present challenges to counting hooks during night time gear deployment or retrieval.

4. Hooks will be taken off the line during retrieval and may be stored in an organized manner such as on a hook rack, around the edge of a tub, or in a pile. You may be able to count these during and at the end of the set to obtain a total hook count. If the vessel is consistent in the manner in which they store their gear, obtaining an accurate count may be possible. This may prove to be an efficient method for obtaining hook counts for total hooks in a set and/or in a sample.
5. Count all the gear on the vessel at the beginning of the trip and use the differences of gear counts on the vessel to determine total hooks set. If the vessel has 1,000 hooks at the beginning of a trip, you may do simple math for each set to obtain an accurate hook count provided you can account for hooks that are lost or removed from use for other reasons.
6. If no hook count was obtained, then the counts from similar sized hauls will be used. On the OHF record the collection # from the Hook Count and Spacing Form where hauls of similar size, or “like sets”, were recorded. See “Snap Gear Hook Count and Spacing Form Instructions” on page 7-25 for hook count recording protocols. The least preferred method to obtain a hook count would be to ask the captain and use unverified information from their haul documentation. This information would not be used to complete a hook collection; rather this value would be entered in the “total hooks” column on the OHF as a hook override.

You may choose to use one or all of the above methods during your time on each vessel. Document your methods in your daily notes. If you decide to use a method not described above, document the sampling method in your daily notes. For an example of snap gear hooks count on the Hook Count and Spacing Form see Figure 7-15.

Snap Gear Partial Segments

If part of a set is lost during the retrieval of gear and you are not able to get an exact count of hooks retrieved,

then you may need to calculate a partial segment based on an estimate of the hooks retrieved. You can get an estimate of hooks retrieved and divide this by the total hooks for the set. Record this under the “# of segments” on the OHF and leave the “Total Hooks” field blank. See “Partial Segments” 7-11 for more partial segment calculation information.

Snap Gear Hook Count and Spacing Form Instructions

Observers on snap gear vessels will record raw hook counts on a Deck Form as they are completed. These data will be entered on the Hook Count and Spacing Form and then into ATLAS. For snap gear, each hook count will be recorded on the paper Hook Count and Spacing Form for the trip as a single collection grouped with other similar sized sets, or “like sets”. The # of hooks in “like sets” will vary from vessel to vessel and what is considered a like set will be somewhat subjective, based on the setting style of the vessel you are on. For example, if all sets range from 350-500 hooks in size, with no real consistency, these hook counts may all be listed under a single collection.

Collections on the Hook Count and Spacing Form will be completed by the observer at least every 3 days, and no less than twice per week, or more frequently if set length varies. These data will be recorded on the Observer Haul Form in the “Total Pots (or Hooks) in Set” column. Fields on the form will be the same as with fixed hook gear with the following differences:

Date: The date recorded on the form will be the day you completed all of the hook counts for a distinct collection.

Collection Number: Number used to reference the hook count on the Observer Haul Form. The number must be unique by permit number, starting with collection number 1. Similar sized hauls should be recorded in the same collection.

Segment Number: The segment number for each individual collection number will be the same as the haul # from which the hook count is taken. For example, haul #2 on the Observer Haul Form will have its hook count listed as segment #2 on the Hook Count and Spacing Form. See “Snap Gear-Completed Hook Count and Spacing Form” on page 7-33 for an example.

Hooks Per Segment: Enter the number of hooks counted on a single haul.

Spacing (cm) and X: Do not complete hook spacing on a snap gear vessel.

Snap Gear Observer Haul Form Rules:

Follow the OHF protocols outlined in “Completing the Observer Haul Form” on page 7-21 except for the following fields:

Hook Collection #: For snap gear, the hook collection number will be same collection number that the haul’s hook count is entered under on the Hook Count and Spacing Form. If you are not able to count hooks for a haul, enter the collection # of the “like sets” from the Hook Count and Spacing Form.

of Segments: On a snap gear vessel the # of segments in a set will always be “1” unless gear is lost. If gear is lost and you are not able to count the hooks retrieved, the # of segments should be listed as a partial segment based on an estimate of the number of hooks retrieved. If you are able to count the number of hooks retrieved for a partial set, record the # of segments as 1 and the actual hooks retrieved in the “Total Hooks in Set” field. See “Partial Segments” on page 7-11 for guidance on calculating partial hook counts. See the OHF snap gear data on page 7-32 for an example.

Total Hooks in Set: Enter the total number of hooks in the snap gear set. This is always an actual count done by the observer. If you count hooks during deployment and retrieval, record only the number of hooks that were retrieved. Do not include lost hooks. The number of segments remains a required entry on the Observer Haul Form, but by entering an actual hook count you override the # that would be calculated by ATLAS.

LONGLINE CATCH FORM EXAMPLES

The following catch form examples illustrate how to properly record longline catch effort data.

Vessel Haul Form

Page 1 of 1

| | | | |
|------------------------|-----------------------|---------------------|--|
| Cruise 21148 | Permit 4540 | Year 2023 | |
|------------------------|-----------------------|---------------------|--|

Observer Name Stevie Nicks
Vessel Name Rhiannon

| Trip No. | Haul No. | IFC? Y/N | CDO No. | Gear type | Vessel Type | Gear Performance | Location Code | Deployment Information | | | | | | | | | | Retrieval Information | | | | | | | | | | | | | |
|----------|----------|----------|---------|-----------|-------------|------------------|---------------|------------------------|-----|-----|------|--------------|------|------|--------|-----------|------|-----------------------|----------------------|--------------------|--------|-----|-----|------|--------------|------|------|--------|-----------|------|------|
| | | | | | | | | Pur. Code | Mo. | Day | Time | Latitude (N) | | | E of W | Longitude | | | Average Bottom Depth | Average Gear Depth | M or F | Mo. | Day | Time | Latitude (N) | | | E of W | Longitude | | |
| | | | | | | | | | | | | Deg. | Min. | Sec. | | Deg. | Min. | Sec. | | | | | | | Deg. | Min. | Sec. | | Deg. | Min. | Sec. |
| | 0 | | | | | | N | | | | | | | | | | | 08 | 13 | | 54 | 08 | | W | 65 | 46 | | | | | |
| | 0 | | | | | | N | | | | | | | | | | | 08 | 14 | | 56 | 36 | 16 | W | 71 | 14 | 01 | | | | |
| 1 | 100 | N | | B | 1 | 1 | R | CA | 08 | 14 | 1405 | 57 | 43 | 10 | W | 73 | 27 | 41 | 75 | | F | 08 | 15 | 0810 | 57 | 54 | 42 | W | 73 | 31 | 12 |
| 1 | 101 | N | | B | 1 | 1 | R | CA | 08 | 15 | 0125 | 56 | 12 | 16 | W | 72 | 19 | 31 | 69 | | F | 08 | 15 | 1541 | 56 | 39 | 27 | W | 72 | 21 | 45 |
| 1 | 102 | N | | B | 1 | 1 | R | CA | 08 | 15 | 1300 | 56 | 41 | 13 | W | 72 | 35 | 15 | 70 | | F | 08 | 15 | 2300 | 56 | 45 | 10 | W | 72 | 24 | 59 |
| 1 | 103 | N | | B | 1 | 1 | R | CA | 08 | 15 | 1555 | 56 | 40 | 25 | W | 72 | 32 | 45 | 76 | | F | 08 | 16 | 0730 | 56 | 44 | 45 | W | 72 | 19 | 11 |
| 1 | 104 | N | | B | 1 | 1 | R | CA | 08 | 16 | 0200 | 56 | 47 | 59 | W | 72 | 17 | 33 | 72 | | F | 08 | 16 | 1730 | 56 | 44 | 19 | W | 72 | 29 | 27 |
| 1 | 105 | N | | B | 1 | 1 | R | CA | 08 | 16 | 1207 | 56 | 45 | 27 | W | 72 | 13 | 10 | 76 | | F | 08 | 17 | 0310 | 56 | 41 | 17 | W | 72 | 27 | 22 |
| 1 | 106 | N | | B | 1 | 1 | R | CA | 08 | 16 | 1030 | 56 | 39 | 08 | W | 72 | 28 | 14 | 75 | | F | 08 | 17 | 0945 | 56 | 43 | 06 | W | 72 | 15 | 26 |
| 1 | 107 | N | | B | 1 | 6 | R | CA | 08 | 17 | 0425 | 56 | 38 | 31 | W | 72 | 27 | 52 | 68 | | F | 08 | 17 | 1800 | 56 | 43 | 12 | W | 72 | 12 | 45 |

Comments:

National Marine Fisheries Service/Fisheries Monitoring and Analysis Division Ver. 2024

Observer Haul Form

Page 1 of 1

| | | | |
|------------------------|-----------------------|---------------------|--|
| Cruise 21148 | Permit 4540 | Year 2023 | |
|------------------------|-----------------------|---------------------|--|

Observer Name Stevie Nicks Vessel Name Rhiannon

| | |
|---------------------------|---------|
| Full Name of Catcher Boat | ADF&G # |
| | |

| Haul No. | Haul Sampled By (Cruise No.) | RST On-Haul? (Y=On, N=Off, X=N/A) | RBT On-Break? (Y=On-Break, N=No Break) | Sample Design | Sample Unit Type | % Monitored for Marine Mammals | Gear descriptor | Fishing Method | Trawl Vessels | | | | Longline and Pot Vessels | | | | | | |
|----------|------------------------------|-----------------------------------|--|---------------|------------------|--------------------------------|-----------------|----------------|-----------------------------------|-------------------------------|-------------------------------|------------|------------------------------|---------------------------------------|--------------|--------------------------------------|---|------------------------|------------------|
| | | | | | | | | | Vessels Total Catch Estimate (mt) | Estimated Discard Weight (kg) | Observers Catch Estimate (kg) | B, C, or W | Density (kg/m ³) | Volumetric Estimate (m ³) | Hook Coll. # | # of Segments in Set (Longline Only) | Total Pots (or Hooks) in Set (required for pot vessel only) | Flow Scale Weight (MT) | Bin/Discard Code |
| 0 | | | | | | | | | | | | | | | | | | | |
| 0 | | | | | | | | | | | | | | | | | | | |
| 100 | 21148 | Y | N | 7 | 1 | 33 | | | 7.95 | 1500 | | | | 1 | 16.00 | | | 5.19 | 1 |
| 101 | 21148 | Y | N | 7 | 1 | 31 | | | 11.77 | 4500 | | | | 1 | 16.00 | | | 6.57 | 1 |
| 102 | 0 | N | N | | | 0 | | | 10.00 | | | | | 1 | 16.00 | | | 5.82 | 1 |
| 103 | 21148 | Y | N | 7 | 1 | 33 | | | 9.72 | 3500 | | | | 1 | 16.00 | | | 6.68 | 1 |
| 104 | 21148 | Y | N | 7 | 1 | 38 | | | 5.50 | 1000 | | | | 1 | 16.00 | | | 4.12 | N |
| 105 | 0 | N | N | | | 0 | | | 7.55 | | | | | 1 | 16.00 | | | 4.59 | 1 |
| 106 | 21148 | Y | N | 7 | 1 | 35 | | | 8.00 | 3000 | | | | 1 | 16.00 | | | 6.23 | 1 |
| 107 | 0 | Y | Y | | | 0 | | | 10.95 | | | | | 2 | 14.00 | | | 6.05 | N |

Comments: Documenting the use of the RST in combination with the RBT.

National Marine Fisheries Service/Fisheries Monitoring and Analysis Division Ver. 2024

Figure 7-9: Examples of VHF and OHF Data From a CP Longline Vessel Fishing for Pacific Cod

Hook Count and Spacing Form

Page 1 of 1

| | |
|--------|--------|
| Cruise | Permit |
| 21148 | 4540 |

Observer Name Stevie Nicks
 Vessel Name Rhiannon

Resubmission
 (Circle All Changes)

Page _____ of _____ for Transmission

Collection Number: 1 Date: 08 / 15 / 2023

| Segment Number | Hooks per Segment | Spacing (cm) → <input checked="" type="checkbox"/> | | | | Segment Number | Hooks per Segment | Spacing (cm) → <input checked="" type="checkbox"/> | | | |
|----------------|-------------------|--|--|--|--|----------------|-------------------|--|--|--|--|
| <u>1</u> | <u>922</u> | | | | | | | | | | |
| <u>2</u> | <u>897</u> | | | | | | | | | | |
| <u>3</u> | <u>905</u> | | | | | | | | | | |
| <u>4</u> | <u>928</u> | | | | | | | | | | |
| | | | | | | | | | | | |
| | | | | | | | | | | | |
| | | | | | | | | | | | |
| | | | | | | | | | | | |
| | | | | | | | | | | | |
| | | | | | | | | | | | |
| | | | | | | | | | | | |
| | | | | | | | | | | | |
| | | | | | | | | | | | |
| | | | | | | | | | | | |
| | | | | | | | | | | | |

DECK FORM Page 1 of _____ for Vessel/Part

Date 08/15/23 Cruise 21148 Permit 4540 Haul No. _____ Offload No. _____

Page _____ of _____ for Haul/Offload

Sample # _____ Sub-Sample # _____ Sample Size: _____ # of Sampled Hooks _____

Presorted Combined Unable to Follow Design No Fish in Sample

| Species | Sex | # | Weight | N. net |
|---------------------------|-----|------------|--------|--------|
| <u>Hook Collection #1</u> | | | | |
| Seg # | | Hooks/seg | | |
| <u>1</u> | | <u>922</u> | | |
| <u>2</u> | | <u>897</u> | | |
| <u>3</u> | | <u>905</u> | | |
| <u>4</u> | | <u>928</u> | | |

Sample # _____ Sub-Sample # _____ Sample Size: _____ # of Sampled Hooks _____

Presorted Combined Unable to Follow Design No Fish in Sample

| Species | Sex | # | Weight | N. net |
|--------------------------------------|-----|-------------|--------|--------|
| <u>Hook Collection #2 - 08/17/23</u> | | | | |
| Seg # | | Hooks/seg | | |
| <u>1</u> | | <u>1000</u> | | |
| <u>2</u> | | <u>1028</u> | | |
| <u>3</u> | | <u>981</u> | | |
| <u>4</u> | | <u>1019</u> | | |

Hook Collection raw data must be transferred directly from the Deck Form to the paper form before entering into ATLAS

Collection Number: 2 Date: 08 / 17 / 2023

| Segment Number | Hooks per Segment | Spacing (cm) → <input checked="" type="checkbox"/> | | | | Segment Number | Hooks per Segment | Spacing (cm) → <input checked="" type="checkbox"/> | | | |
|----------------|-------------------|--|--|--|--|----------------|-------------------|--|--|--|--|
| <u>1</u> | <u>1000</u> | | | | | | | | | | |
| <u>2</u> | <u>1028</u> | | | | | | | | | | |
| <u>3</u> | <u>981</u> | | | | | | | | | | |
| <u>4</u> | <u>1019</u> | | | | | | | | | | |
| | | | | | | | | | | | |
| | | | | | | | | | | | |
| | | | | | | | | | | | |
| | | | | | | | | | | | |
| | | | | | | | | | | | |
| | | | | | | | | | | | |
| | | | | | | | | | | | |
| | | | | | | | | | | | |
| | | | | | | | | | | | |
| | | | | | | | | | | | |
| | | | | | | | | | | | |
| | | | | | | | | | | | |
| | | | | | | | | | | | |
| | | | | | | | | | | | |

Figure 7-10: Hook Count and Spacing Form for a CP Longline Vessel Fishing for Pacific Cod

LONGLINE CATCH DATA COLLECTION: LONGLINE CATCH FORM EXAMPLES

| | | |
|-----------------|----------------|--------------|
| Cruise 26200 | Permit 1113 | Year 2023 |
|-----------------|----------------|--------------|

Trip Data Form

Observer name Ray Thomas

Vessel name Blue World

Resubmission (Circle All Changes)

Page 1 of 1 for vessel

| Trip No. | Crew Size | Fish in hold at start? | Port of Trip Start | Trip Start Position | | | Start Date | Time of trip start | Port of Trip End | Trip End Position | | | End Date | Time of Trip End | Did fishing occur? | Bait Used? | Time Lost at Sea (Hours) | | | | | | |
|----------|-----------|------------------------|--------------------|---------------------|------|--------|------------|--------------------|------------------|-------------------|-------|--------------|----------|------------------|--------------------|------------|--------------------------|-----------------|--|---------------------|--------------------------|---------------------|-------------------------------------|
| | | | | Latitude (N) | | E or W | | | | Longitude (100) | | Latitude (N) | | | | | E or W | Longitude (100) | | Mechanical problems | Weather related problems | Crew related issues | USCG / Enforcement related stoppage |
| Deg. | Min. | Sec. | Deg. | Min. | Sec. | Month | Day | Deg. | Min. | Sec. | Month | Day | Y | M | | | | | | | | | |
| 1 | 12 | N | 14 | | | | 06 | 14 | 1430 | 14 | | | 06 | 16 | 2330 | Y | 5 | | | | | | |
| 2 | 12 | N | 14 | | | | 06 | 16 | 0210 | 14 | | | 06 | 18 | 0420 | Y | 5 | | | | | | |

Comments:

Page _____ of _____ for transmission

| | | |
|-----------------|----------------|--------------|
| Cruise 26200 | Permit 1113 | Year 2023 |
|-----------------|----------------|--------------|

Vessel Haul Form

Observer Name Ray Thomas

Vessel Name Blue World

Page 1 of 1

| Trip No. | Haul No. | IFO? Y/N | CDQ No. | Gear Type | Vessel Type | Gear Performance | Location Code | Pur. Code | Deployment Information | | | | | | | Retrieval Information | | | | | | | | | | | | | | |
|----------|----------|----------|---------|-----------|-------------|------------------|---------------|-----------|------------------------|------|------|--------------|------|------|--------|-----------------------|------|------|----------------------|--------------------|--------|------|------|------|--------------|----|---|--------|-----------|----|
| | | | | | | | | | Mo. | Day | Time | Latitude (N) | | | E or W | Longitude | | | Average Bottom Depth | Average Gear Depth | M or F | Mo. | Day | Time | Latitude (N) | | | E or W | Longitude | |
| Deg. | Min. | Sec. | Deg. | Min. | Sec. | Deg. | Min. | Sec. | Deg. | Min. | Sec. | Deg. | Min. | Sec. | Mo. | Day | Time | Deg. | Min. | Sec. | Deg. | Min. | Sec. | | | | | | | |
| | 0 | | | | | | N | | | | | | | | | | | | | | | | | | | | | | | |
| 1 | 46 | Y | | B | 3 | 1 | R | CA | 06 | 14 | 1218 | 58 | 46 | 10 | W | 45 | 51 | 133 | 360 | F | 06 | 15 | 1114 | 58 | 32 | 22 | W | 45 | 50 | 46 |
| 1 | 47 | Y | | B | 3 | 1 | R | CA | 06 | 14 | 1825 | 58 | 32 | 40 | W | 45 | 52 | 30 | 320 | F | 06 | 15 | 1512 | 58 | 44 | 31 | W | 45 | 51 | 53 |
| 1 | 49 | Y | | B | 3 | 1 | R | CA | 06 | 15 | 1639 | 58 | 28 | 13 | W | 45 | 46 | 41 | 280 | F | 06 | 16 | 0908 | 58 | 38 | 40 | W | 45 | 50 | 31 |
| 1 | 48 | Y | | B | 3 | 1 | R | CA | 06 | 15 | 2236 | 58 | 31 | 26 | W | 45 | 45 | 15 | 300 | F | 06 | 16 | 1743 | 58 | 40 | 20 | W | 45 | 49 | 41 |
| 2 | 50 | Y | | B | 3 | 1 | R | CA | 06 | 16 | 1013 | 58 | 33 | 30 | W | 45 | 45 | 33 | 393 | F | 06 | 17 | 0852 | 58 | 41 | 15 | W | 45 | 30 | 30 |
| 2 | 51 | Y | | B | 3 | 1 | R | CA | 06 | 16 | 1842 | 58 | 30 | 26 | W | 45 | 46 | 42 | 375 | F | 06 | 17 | 1409 | 58 | 38 | 30 | W | 45 | 48 | 15 |
| 2 | 52 | Y | | B | 3 | 1 | R | CA | 06 | 17 | 0931 | 58 | 28 | 10 | W | 45 | 44 | 24 | 331 | F | 06 | 17 | 2042 | 58 | 36 | 43 | W | 45 | 46 | 40 |
| | 0 | | | | | | N | | | | | | | | | | | | | | | | | | | | | | | |

Comments:

Page _____ of _____ for transmission

Figure 7-11: Examples of Trip Form and VHF Form from a Catcher Longline Vessel Fishing for Sablefish and Halibut

LONGLINE CATCH DATA COLLECTION: LONGLINE CATCH FORM EXAMPLES

Page 1 of 1

| | | | | | | |
|------------------------|-----------------------|---------------------|------------------------------------|----------------------------------|--|---------|
| Cruise 26200 | Permit 1113 | Year 2023 | Observer Haul Form | | | |
| | | | Observer Name Ray Thomas | Vessel Name Blue World | | |
| | | | Full Name of Catcher Boat | | | ADF&G # |
| | | | | | | |

| Haul No. | Haul Sampled By (Cruise No.) | RST On Haul? (Y=On, N=Off, or N/A) | RBT On Break? (Y=On Break, N=No Break) | Sample Design | Sample Unit Type | % Monitored for Marine Mammals | Gear descriptor | Fishing Method | Trawl Vessels | | | | | Longline and Pot Vessels | | | | | | | |
|----------|------------------------------|------------------------------------|--|---------------|------------------|--------------------------------|-----------------|----------------|-----------------------------------|-------------------------------|-------------------------------|------------|------------------------------|---------------------------------------|--------------|--------------------------------------|---|------------------------|-----------------|--|---|
| | | | | | | | | | Vessels Total Catch Estimate (mt) | Estimated Discard Weight (kg) | Observers Catch Estimate (kg) | B, C, or W | Density (kg/m ³) | Volumetric Estimate (m ³) | Hook Coll. # | # of Segments in Set (Longline Only) | Total Pots (or Hooks) in Set (required for pot vessel only) | Flow Scale Weight (MT) | Flow Scale Code | | |
| 0 | | | | | | | | | | | | | | | | | | | | | |
| 46 | 26200 | X | N | 7 | 1 | 38 | | | 1.95 | 600 | | | | 1 | 26.00 | 2476 | | | | | N |
| 47 | 26200 | X | N | 7 | 1 | 33 | | | .96 | 220 | | | | 2 | 18.00 | | | | | | N |
| 49 | 26200 | X | N | 7 | 1 | 33 | | | .40 | 800 | | | | 1 | 18.00 | | | | | | I |
| 48 | 26200 | X | N | 7 | 1 | 34 | | | 1.77 | 300 | | | | 2 | 18.00 | | | | | | N |
| 50 | 26200 | X | N | 7 | 1 | 40 | | | 2.37 | 120 | | | | 3 | 18.00 | | | | | | I |
| 51 | 26200 | X | N | 7 | 1 | 38 | | | 1.41 | 60 | | | | 4 | 18.00 | | | | | | I |
| 52 | 26200 | X | N | 7 | 1 | 33 | | | 1.41 | 50 | | | | 4 | 18.00 | | | | | | I |
| 0 | | | | | | | | | | | | | | | | | | | | | |

Comments: **H46-mixed gear: Sablefish - 22 @ 99 hks = 2178.0
Halibut - 4 @ 74.4 hks = 297.6 Σ 2475.6 total hooks**

National Marine Fisheries Service/Fisheries Monitoring and Analysis Division Ver. 2024

Page 1 of

| | | | | | | | |
|------------------------|-----------------------|---------------------|------------------------------------|--|--|------------------------|-------------------|
| Cruise 26200 | Permit 1113 | Year 2023 | Plant/Vessel Offload Form | | | | |
| | | | Observer Name Ray Thomas | Vessel/Plant Name Blue World | | | |
| | | | Catcher Boat Name | | | Catcher Boat ADF&G No. | Vessel Permit No. |
| | | | | | | | |

| Offload Trip(s) | | Offload No. | Completion Date | | Gear Type | NMFSA Area | Total Delivered | Kg or Lb | Total Pollock Weight <small>BSAJ Pollock Only</small> | Were All Groundfish Weighed? (Y/N) | ADF&G No. of Delivering Vessel | Receiving Processor Permit No. <small>Vessels Only</small> | Was Catch Sorted? (Y/N) | Tender Officer? (Y/N) | Landing Report ID No. | Elanding Management Program | CDO No. |
|-----------------|------|-------------|-----------------|-----|-----------|------------|-----------------|----------|--|------------------------------------|--------------------------------|---|-------------------------|-----------------------|-----------------------|-----------------------------|---------|
| First | Last | | Month | Day | | | | | | | | | | | | | |
| 1 | 1 | 1 | 06 | 17 | | 13227 | LB | | | | | 71130 | Y | N | 190777 | | |
| 2 | 2 | 2 | 06 | 19 | | 11023 | LB | | | | | 71130 | Y | N | 196321 | | |

Notes:

National Marine Fisheries Service/Fisheries Monitoring and Analysis Division Page _____ of _____ for Transmission Ver. 2014

Figure 7-12: Examples of OHF and Offload Data From a Catcher Longline Vessel Fishing for Sablefish and Halibut

Hook Count and Spacing Form

Page 1 of

| | |
|--------|--------|
| Cruise | Permit |
| 26200 | 1113 |

Observer Name Ray Thomas

Resubmission
(Circle All Changes)

Vessel Name Blue World

Page of for Transmission

| Collection Number: <u>1 (Blackcod)</u> | | | | | | | | Date: <u>06 / 14 / 2023</u> | | | | | | | | | |
|--|-------------------|----------------|-----|-----|-----|-----|-----|-----------------------------|----------------|-------------------|----------------|--|--|--|--|--|---|
| Segment Number | Hooks per Segment | Spacing (cm) → | | | | | | X | Segment Number | Hooks per Segment | Spacing (cm) → | | | | | | X |
| 1 | 102 | 151 | 150 | 152 | 151 | 150 | 151 | | | | | | | | | | |
| 2 | 95 | 152 | 150 | 150 | 151 | 152 | 151 | | | | | | | | | | |
| 3 | 98 | 150 | 149 | 150 | 151 | 151 | 150 | | | | | | | | | | |
| 4 | 105 | 150 | 149 | 151 | 150 | 151 | 150 | | | | | | | | | | |
| 5 | 95 | 148 | 150 | 150 | 152 | 150 | 150 | | | | | | | | | | |
| | | | | | | | | | | | | | | | | | |
| | | | | | | | | | | | | | | | | | |
| | | | | | | | | | | | | | | | | | |
| | | | | | | | | | | | | | | | | | |
| | | | | | | | | | | | | | | | | | |
| | | | | | | | | | | | | | | | | | |
| | | | | | | | | | | | | | | | | | |
| | | | | | | | | | | | | | | | | | |
| | | | | | | | | | | | | | | | | | |

| Collection Number: <u>2 (Halibut)</u> | | | | | | | | Date: <u>06 / 14 / 2023</u> | | | | | | | | | |
|---------------------------------------|-------------------|----------------|--|--|--|--|--|-----------------------------|----------------|-------------------|----------------|--|--|--|--|--|---|
| Segment Number | Hooks per Segment | Spacing (cm) → | | | | | | X | Segment Number | Hooks per Segment | Spacing (cm) → | | | | | | X |
| 1 | 73 | | | | | | | | | | | | | | | | |
| 2 | 70 | | | | | | | | | | | | | | | | |
| 3 | 79 | | | | | | | | | | | | | | | | |
| 4 | 75 | | | | | | | | | | | | | | | | |
| 5 | 75 | | | | | | | | | | | | | | | | |
| | | | | | | | | | | | | | | | | | |
| | | | | | | | | | | | | | | | | | |
| | | | | | | | | | | | | | | | | | |
| | | | | | | | | | | | | | | | | | |
| | | | | | | | | | | | | | | | | | |
| | | | | | | | | | | | | | | | | | |
| | | | | | | | | | | | | | | | | | |
| | | | | | | | | | | | | | | | | | |
| | | | | | | | | | | | | | | | | | |
| | | | | | | | | | | | | | | | | | |
| | | | | | | | | | | | | | | | | | |

Figure 7-13: Example of a Hook Count and Spacing Form for a Catcher Vessel Longliner fishing for Sablefish and Halibut

LONGLINE CATCH DATA COLLECTION: LONGLINE CATCH FORM EXAMPLES

| Cruise | | Permit | | Year | | Vessel Haul Form | | | | | | | | | | | | | | | | | | | | Page <u> 1 </u> of <u> 1 </u> | | | | | | | | | | | | | | | |
|--------|--|--------|--|------|--|--------------------------------------|--|--|--|--|--|--|--|--|--|--|--|--|--|-----------------------------|--|--|--|--|--|-------------------------------|--|--|--|--|--|--|--|--|--|--|--|--|--|--|--|
| 25456 | | 78910 | | 2023 | | Observer Name <u> Tatiana Smith </u> | | | | | | | | | | | | | | | | | | | | | | | | | | | | | | | | | | | |
| | | | | | | | | | | | | | | | | | | | | Vessel Name <u> Pisces </u> | | | | | | | | | | | | | | | | | | | | | |

| Deployment Information | | | | | | | | | | | | Retrieval Information | | | | | | | | | | | | | | | | | | | | | | |
|------------------------|----------|---------|---------|-----------|-------------|------------------|---------------|-----------|-----|------|------|-----------------------|------|------|--------|-----------|------|------|----------------------|--------------------|--------|-----|-----|------|--------------|------|------|--------|-----------|------|------|----|----|--|
| Trip No. | Haul No. | FG? Y/N | CDQ No. | Gear Type | Vessel Type | Gear Performance | Location Code | Pur. Code | Mo. | Day | Time | Latitude (N) | | | E or W | Longitude | | | Average Bottom Depth | Average Gear Depth | M or F | Mo. | Day | Time | Latitude (N) | | | E or W | Longitude | | | | | |
| | | | | | | | | | | | | Deg. | Min. | Sec. | | Deg. | Min. | Sec. | | | | | | | Deg. | Min. | Sec. | | Deg. | Min. | Sec. | | | |
| | 0 | | | | | | N | | | | | | | | | | | | | | | | | 07 | 04 | | | 51 | 53 | 53 | W | 76 | 39 | |
| 1 | 1 | Y | | 8 | 3 | 1 | CA | 07 | 05 | 0604 | 50 | 33 | 54 | W | 77 | 56 | 18 | 103 | | | F | 07 | 05 | 1408 | 50 | 40 | 50 | W | 77 | 54 | 36 | | | |
| 1 | 2 | Y | | 8 | 3 | 1 | CA | 07 | 05 | 0802 | 50 | 32 | 42 | W | 77 | 57 | 48 | 99 | | | F | 07 | 05 | 1442 | 50 | 28 | 23 | W | 78 | 00 | 12 | | | |
| 1 | 3 | Y | | 8 | 3 | 1 | CA | 07 | 05 | 1507 | 50 | 33 | 00 | W | 77 | 57 | 48 | 163 | | | F | 07 | 06 | 0901 | 50 | 28 | 30 | W | 77 | 53 | 30 | | | |
| 1 | 4 | Y | | 8 | 3 | 6 | CA | 07 | 05 | 2115 | 50 | 31 | 48 | W | 77 | 56 | 12 | 175 | | | F | 07 | 06 | 1257 | 50 | 25 | 00 | W | 77 | 52 | 08 | | | |
| 1 | 5 | Y | | 8 | 3 | 1 | CA | 07 | 06 | 1004 | 50 | 42 | 35 | W | 77 | 56 | 25 | 175 | | | F | 07 | 06 | 2312 | 51 | 53 | 43 | W | 77 | 39 | 50 | | | |
| 1 | 6 | Y | | 8 | 3 | 1 | CA | 07 | 06 | 1452 | 50 | 42 | 33 | W | 77 | 52 | 05 | 115 | | | F | 07 | 07 | 0504 | 50 | 44 | 38 | W | 77 | 48 | 42 | | | |
| 1 | 7 | Y | | 8 | 3 | 1 | CA | 07 | 07 | 0108 | 50 | 38 | 46 | W | 77 | 41 | 20 | 137 | | | F | 07 | 07 | 0852 | 50 | 36 | 55 | W | 77 | 38 | 00 | | | |
| 1 | 8 | Y | | 8 | 3 | 1 | CA | 07 | 07 | 0603 | 50 | 31 | 34 | W | 77 | 35 | 06 | 163 | | | F | 07 | 07 | 1203 | 50 | 28 | 13 | W | 77 | 31 | 39 | | | |
| | 0 | | | | | | N | | | | | | | | | | | | | | | | | 07 | 08 | | | 51 | 53 | | W | 76 | 39 | |

Comments: H4-Line parted, gear lost

National Marine Fisheries Service/Fisheries Monitoring and Analysis Division Ver. 2024

| Cruise | | Permit | | Year | | Observer Haul Form | | | | | | | | | | | | | | | | | | | | Page <u> 1 </u> of <u> 1 </u> | | | | | |
|--------|--|--------|--|------|--|--------------------------------------|--|--|--|--|--|--|--|--|--|--|--|--|--|--|--|--|--|--|--|-------------------------------|--|---------------------------------|--|---------------|--|
| 25456 | | 78910 | | 2023 | | Observer Name <u> Tatiana Smith </u> | | | | | | | | | | | | | | | | | | | | Vessel Name <u> Pisces </u> | | Full Name of Catcher Boat _____ | | ADF&G # _____ | |

| Haul No. | Haul Sampled By (Cruise No.) | RST On Haul? (Yes, On, No Off, No N/A) | RBT On Break? (Yes, No Break, No No Break) | Sample Design | Sample Unit Type | % Monitored for Marine Mammals | Gear descriptor | Fishing Method | Trawl Vessels | | | | | Longline and Pot Vessels | | | | | | | | | | | | | |
|----------|------------------------------|--|--|---------------|------------------|--------------------------------|-----------------|----------------|-----------------------------------|-------------------------------|-------------------------------|------------|------------------------------|---------------------------------------|--------------|--------------------------------------|---|------------------------|-----------------|--|--|--|--|--|--|--|--|
| | | | | | | | | | Vessels Total Catch Estimate (mt) | Estimated Discard Weight (kg) | Observers Catch Estimate (kg) | B, C, or W | Density (kg/m ³) | Volumetric Estimate (m ³) | Hook Coll. # | # of Segments in Set (Longline Only) | Total Pits (or Hooks) in Set (required for pot vessel only) | Flow Scale Weight (MT) | Flow Scale Code | | | | | | | | |
| 0 | | | | | | | | | | | | | | | | | | | | | | | | | | | |
| 1 | 25456 | X | N | 7 | 1 | 40 | | | .50 | 200 | | | . | . | 1 | 1.00 | 367 | . | 3 | | | | | | | | |
| 2 | 25456 | X | N | 7 | 1 | 33 | | | .80 | 100 | | | . | . | 1 | 1.00 | 358 | . | 3 | | | | | | | | |
| 3 | 25456 | X | N | 7 | 1 | 34 | | | .42 | 42 | | | . | . | 1 | 1.00 | 369 | . | 3 | | | | | | | | |
| 4 | 25456 | X | N | 7 | 1 | 33 | | | .75 | 100 | | | . | . | 1 | .90 | | . | 3 | | | | | | | | |
| 5 | 25456 | X | N | 7 | 1 | 36 | | | .56 | 100 | | | . | . | 2 | 1.00 | 540 | . | 3 | | | | | | | | |
| 6 | 0 | X | N | | | | | | 1.23 | 250 | | | . | . | 1 | 1.00 | | . | N | | | | | | | | |
| 7 | 25456 | X | N | 7 | 1 | 33 | | | .40 | 40 | | | . | . | 1 | 1.00 | 382 | . | 3 | | | | | | | | |
| 8 | 25456 | X | N | 7 | 1 | 36 | | | .75 | 75 | | | . | . | 2 | 1.00 | 581 | . | 3 | | | | | | | | |
| 0 | | | | | | | | | | | | | . | . | | | | . | | | | | | | | | |

Comments: H4-Line broke, captain estimates 10% of gear lost
H6- Did not sample due to very rough weather

National Marine Fisheries Service/Fisheries Monitoring and Analysis Division Ver. 2024

Figure 7-14: Examples of VHF Form and OHF Form from a Snap Gear Longline Catcher Vessel

Hook Count and Spacing Form

| | |
|--------|--------|
| Cruise | Permit |
| 25456 | 78910 |

Observer Name Tatiana Smith

Resubmission
(Circle All Changes)

Vessel Name Pisces

Page _____ of _____ for Transmission

Collection Number: 1 Date: 07 / 07 / 2023

| Segment Number | Hooks per Segment | Spacing (cm) → | | | | | X | Segment Number | Hooks per Segment | Spacing (cm) → | | | | | X |
|----------------|-------------------|----------------|--|--|--|--|---|----------------|-------------------|----------------|--|--|--|--|---|
| 1 | 367 | | | | | | | | | | | | | | |
| 2 | 358 | | | | | | | | | | | | | | |
| 3 | 369 | | | | | | | | | | | | | | |
| 4 | 397 | | | | | | | | | | | | | | |
| 7 | 382 | | | | | | | | | | | | | | |
| | | | | | | | | | | | | | | | |
| | | | | | | | | | | | | | | | |
| | | | | | | | | | | | | | | | |
| | | | | | | | | | | | | | | | |
| | | | | | | | | | | | | | | | |
| | | | | | | | | | | | | | | | |
| | | | | | | | | | | | | | | | |
| | | | | | | | | | | | | | | | |
| | | | | | | | | | | | | | | | |

Collection Number: 2 Date: 07 / 07 / 2023

| Segment Number | Hooks per Segment | Spacing (cm) → | | | | | X | Segment Number | Hooks per Segment | Spacing (cm) → | | | | | X |
|----------------|-------------------|----------------|--|--|--|--|---|----------------|-------------------|----------------|--|--|--|--|---|
| 5 | 540 | | | | | | | | | | | | | | |
| 8 | 581 | | | | | | | | | | | | | | |
| | | | | | | | | | | | | | | | |
| | | | | | | | | | | | | | | | |
| | | | | | | | | | | | | | | | |
| | | | | | | | | | | | | | | | |
| | | | | | | | | | | | | | | | |
| | | | | | | | | | | | | | | | |
| | | | | | | | | | | | | | | | |
| | | | | | | | | | | | | | | | |
| | | | | | | | | | | | | | | | |
| | | | | | | | | | | | | | | | |
| | | | | | | | | | | | | | | | |
| | | | | | | | | | | | | | | | |
| | | | | | | | | | | | | | | | |

National Marine Fisheries Service/Fisheries Monitoring and Analysis Division - OMB Control No. 0648-0593, expires 9-30-2012

Cr. 2010

Figure 7-15: Snap Gear- Completed Hook Count and Spacing Form

This page intentionally left blank

LONGLINE COMPOSITION SAMPLING



Table of Contents

| | |
|---|------|
| Priorities | 8-2 |
| Composition Sampling Guidelines | 8-2 |
| Selecting Sets to Sample | 8-3 |
| Longline Species Composition Samples and Subsamples | 8-4 |
| Number of Samples per Sampled Set | 8-4 |
| Sample Size Considerations | 8-4 |
| Random Sampling on Longliners | 8-5 |
| Sampling Rules | 8-5 |
| Spatial Frames on Longliners | 8-5 |
| Addressing Challenging Sampling Situations | 8-9 |
| Tally Composition Samples | 8-9 |
| Method for Tallying Predominant Species | 8-10 |
| Method for Tallying Non-Predominant Species | 8-10 |
| Method for Tallying Drop-Offs and Discarded Species at the Rail of Retained Species | 8-10 |
| Method for Tallying Depredated Items | 8-11 |
| Crab Pots and Large Items | 8-12 |
| Method for Tallying Pieces of Miscellaneous Items | 8-12 |
| Species Identification Rules | 8-12 |
| Tallying Seabirds | 8-15 |
| Tallying Corals | 8-15 |
| Tally Visibility Challenges | 8-15 |
| Weight Samples | 8-15 |
| Subset Sampling for Non-Predominant Species | 8-16 |
| Subsamples for Predominant Species | 8-17 |
| When Halibut is the Predominant Species | 8-17 |
| Sample Bias | 8-18 |
| Recording Subset and Tally data in species composition | 8-18 |
| Discrepancies Between Tally and Weight Samples | 8-19 |
| Combined Samples | 8-19 |
| Dealing with Time and Space Constraints on Longline Vessels | 8-20 |
| Halibut Injury Assessments | 8-20 |
| Careful Release Methods for Halibut | 8-21 |
| Seabirds | 8-21 |
| Estimating Percent Retained | 8-21 |
| Specimen Collection on Longliners | 8-22 |
| Catcher Processor (CP) Monitoring Options | 8-23 |
| Individual Fishing Quota (IFQ) | 8-24 |
| Composition Sampling | 8-24 |
| Halibut IFQ Vessels Fishing in State Waters | 8-24 |
| Bycatch Retention | 8-24 |
| When Halibut is the Predominant Species | 8-25 |
| CDQ Specific Information for Fixed Gear Catcher Vessels | 8-25 |
| CDQ Specific Information for Fixed Gear Catcher/Processors | 8-25 |
| Deck Form Instructions | 8-26 |
| Snap Gear Species Composition sampling | 8-29 |
| Snap Gear Sample Design | 8-29 |
| Snap gear Composition Samples | 8-30 |
| Longline Deck Form Examples | 8-31 |

PRIORITIES

- Your safety!
- Collect data and specimens from marine mammal and endangered seabird mortalities.
- Rehabilitate ESA-listed seabird species.
- Sample for species composition.
- Send data to the Observer Program as directed (see “Sending Data” on page 2-39).
- Document any compliance concerns.
- Measure and assess injury of Pacific halibut.
- Measure and determine the sex of other prohibited species.
- Collect biological data
- Collect sexed length frequencies
- Complete research projects.

INTRODUCTION

Species composition sampling is high on the Observer Program’s priority list, and more time is spent on this task than any other. Species composition sampling is the collection of catch samples from a selected haul.

Fisheries managers base their assessment of catch rate on the results of your species composition samples. The data you collect are used to monitor allowable harvest and is used by scientists for population analysis and stock assessment.

Keep in mind during your composition sampling efforts that complete, accurate, and verified haul data is required for management and accurate haul data is a higher priority than composition sampling.

COMPOSITION SAMPLING GUIDELINES

One of the first things you should do when you arrive on a vessel is to become familiar with your boat and its fishing operations. Inspect your sample station and any other areas where you might be working. This will help you determine how you will sample on this boat. Refer to “Becoming Familiar with Your Vessel” on page 2-4

and for guidelines specific to longliners, see “Longline Vessel” on page 2-6. When deciding how to sample on this vessel, consider the following:

- Safety on deck, in the factory, or any other area where you will be working.
- Where to tally your sample
- Where to collect and contain your weight sample
- What sampling biases could occur in your collection and how to minimize them
- How to collect your sample
- How many samples you will be able to collect
- What sample sizes you will be able to collect
- How you will process your sample
- Do you need to use the Random Sampling Table (RST) or Random Break Table (RBT)

Equipment: You will need at least three to six thumb counters, a clipboard, and Deck Forms. Prior observers have devised many innovative techniques that have made using multiple thumb counters easier. The most common is to duct tape multiple thumb counters to a clipboard. Be creative, experiment, and find what works best for you.

It is important to check the functionality of your thumb counters and to oil them on a regular basis. This will ensure that your thumb counters work properly during your tally periods.

Tally Station: The tally station is where you stand to count organisms as the groundline is retrieved. You must have a clear line of sight to the groundline as it exits the water. The Observer Program suggests that the tally station is never more than five meters from where fish are landed. This is a requirement for catcher processors with certified sampling/tally stations. From your tally station, you must be able to see the groundline coming out of the water, identify fish as they come aboard, and identify drop-offs using species identification rules discussed later in this chapter. If you are having trouble seeing the groundline from available tally areas, see “Tally Visibility Challenges” on page 8-15.

Choose a location that is safe, away from direct wave action, and out of the way of the pole gaffer and roller

man. Your tally station must have adequate railings to prevent you from falling overboard. For added safety, try to find a location where you are visible to the captain and/or crew. On catcher processors, often the best place will be on the weather deck, above the roller station. On small vessels a bait shed may cover the back deck. The bait shed is not a weather deck. The observer program does not recommend tallying from this location as railings tend to be low, access often is limited and you are obscured from the view of the crew. *Never tally from inside the wheelhouse.*

Sample Station: The sample station is the location where you will weigh and measure catch. Many CP vessels have a sample station already set up for observer use and most have motion compensated platform scales. On vessels that do not have established stations, select a location that is out of wave action, out of crew traffic, and has enough room to store one or two baskets of fish. The location should be as close as possible to where the fish come on board. On some vessels, you won't have much choice where you set up a sampling station and you will have to work with the area available to you. Explain your needs to the crew and work with them as much as possible.

Draw a diagram of the sampling station in your logbook. In your Daily Notes, discuss the random sample design you intend to use. Your sample design will be put to the test once you start sampling, and you may find that you need to make some changes to it. When you have settled on a random sample design(s), fill out a Sample Design Detail form in your logbook. On this form, describe your sampling design in detail. Day-to-day minor adjustments to the random sample design can be documented in the Daily Notes section of your logbook.

Inexperienced observers should be especially careful until they are familiar with the way catch is handled. You may need to reduce your sampling effort during the retrieval of the first few hauls (fewer and/or smaller samples). Document your methods and the reasons for the reduced sampling effort in your Daily Notes. After only a few hauls you will be familiar with the catch handling process and able to decide on a sampling design that is right for that vessel and fishery. If you are unable to sample a haul for any reason, you must document the circumstances in your log book.



Be sure to discuss safe deck practices, hauling procedures and potential sampling needs with the vessel before fishing begins!

You may alter your design as you gain experience, become aware of biases, species composition changes, or target fishery changes. Document all changes in the Daily Notes section of your logbook and explain why they were made. Sample designs for longline sampling are discussed in detail starting on page 8-5. If you have problems designing or implementing a sampling design, contact your ATLAS inseason advisor or other Observer Program staff member as soon as possible.

Selecting Sets to Sample

On some vessels, you will be able to sample every set. This is typically the case for observers on catcher vessels targeting Sablefish and Pacific halibut or if you are on a vessel with another observer. In general, observers on catcher vessels familiar with the fishery are expected to sample all sets when less than three per day are landed or if the boat only fishes for part of the day. Catcher/processor longline vessels are the exception to this generality, and observers may need to use the RST or RBT on a longline CP retrieving more than two sets a day. When extenuating circumstances prevent you from following these guidelines, you must document the situation in your logbook.

If you cannot collect species composition data from all sets, you must randomly select which sets to sample using the appropriate Random Sample Table (RST) and/or Random Break table (RBT). Please refer to "How to Use the RST" on page 2-19 for instructions on using the RST and "How to Use the RBT" on page 2-19 for instructions on using the RBT. Consult with Observer Program staff if you frequently use the RST and RBT together as the sampling effort for that vessel will be low.

Preferred Sampling Method

There are several sampling methods available to you for collecting samples. These are covered in "Random Sampling on Longliners" on page 8-5. As discussed in the section "Introduction to Sampling Theory" on page 2-21, the preferred method is to take *systematic random samples*. Longline fishing is unique in that gear can span large distances. Spacing of samples throughout a set accounts for any fish stratification associated with topography changes over these distances.

To achieve systematic random sampling on longliners, the set is divided into sampling units of equal size. Units to sample are chosen using a systematic random design.

Longline Species Composition Samples and Subsamples

Longline species composition sampling is unique from that on other vessel types. The collection of data regarding the types and numbers of individuals within a sample must occur independently of the actual weighing of the sampled species. It is impractical to combine the two sampling elements: the tally station is typically not close to the collection site and weighing fish while at the same time tallying is next to impossible. By physically separating tally sessions from weighing sessions, you are ensuring that the critical process of getting an accurate tally of fish in a sample is given the attention it needs.

The terms *tally-period* and *non-tally period* are used to discuss the two distinct composition data collection periods on longliners. During the tally period, *everything* that comes up on a hook during randomly chosen segments of gear must be counted, or *tallied*. It is very important to remember that *all catch is counted*, including those species that are not retained or brought on board the vessel (drop-offs and invertebrates for example). During the tally period, the only thing you do is tally! The tally period always occurs as gear is being retrieved.

Tallying fish on the line is only a part of the species composition sampling process. Fisheries managers base their assessments of fish mortality rate on weight taken from the biomass. To supply resource managers with the essential information they need, you also collect weight information and biological data for the species tallied. Non-predominant species tallied are collected by the rollerman, at your request, during the tally period. The task of weighing them is accomplished during non-tally periods, while the gear is still being retrieved.

Weights and other biological data are also needed for the predominant species, but because you need about 60 individuals total for these data, it is not practical to collect these fish during your tally period. For this reason, predominant species are collected outside the tally period. Less frequently, you may need to collect *non-predominant* fish from outside the tally period as well. Two reasons you might resort to this are space constraints and high species diversity. Non-tally periods are also used for halibut injury assessments, halibut

measurements, and performing other duties. If assigned to an IFQ vessel see “Individual Fishing Quota (IFQ)” on page 8-24 for further instructions.

Information from a single tally period, and any fish you collect for weights during that tally period, are recorded together as a distinct sample. Fish collected outside the tally period are recorded separately as a subsample. Observers are asked to try and collect any subsample fish from segments of gear as close to the tally period segments as possible. By doing so, statisticians and data managers can make the assumption that subsample fish are from the same population as the tally period fish.

A specific numbering system is used to link subsample data to tally sample data in the database. This numbering convention is discussed on page 8-27. To indicate this relationship the term “parent sample” is used. For any subsample, the parent sample is the sample immediately adjacent to the subsample.

Number of Samples per Sampled Set

You should take as many individual samples within a set as feasibly possible. Multiple samples, taken systematically throughout the set, capture any changes to the population due to stratification. *At least three discrete composition samples of approximately equal sized units are required for every sampled haul to allow data users to assess sample variance.*

There may be fisheries and vessel types where it is not possible to collect multiple species composition samples within a sampled set. In those instances, you must document the circumstances in your Daily Notes.

Sample Size Considerations

When deciding the size of your tally samples, consider your general health, weather conditions, the size of the set and species diversity. Reduce the size of your tally samples if you are not feeling well, conditions are unfavorable, have not had enough sleep, or if species diversity is high.

Tally samples taken within a set should be the same size. This is easy to achieve on longliners, because the crew is working with discrete segments of gear. The total number of segments you are able to sample depends on vessel specific factors, but most observers find they can sample at least 1/3 of a set and still have time to attend to their other sampling duties. If you find you cannot routinely tally at least 1/3 of a set, document the circumstances

in your observer logbook and contact your inseason advisor or other Observer Program staff member for guidance.

All segments sampled for species composition must be documented on your deck sheets as tally marks or total counts for those species tallied using a thumb counters. This is a tool for you and your debriefer to verify the number of segments tallied per sample.

Snap gear Sampling Considerations

Sample size and methods are similar for vessels using snap gear with the exception that snap gear vessels rarely fish segmented gear. Even when each segment is easily distinguishable the number of hook in each segment is too variable to sample based on segments. The desired sample effort on snap gear vessels is 1/3 of the hooks retrieved over multiple samples. See “Snap Gear Species Composition Sampling” on page 8-29 for snap gear sampling specifics and guidelines for snap gear sample designs.

RANDOM SAMPLING ON LONGLINERS

Two types of sample designs can be used on longliners:

1. gear based simple random,
2. gear based systematic random,

A systematic random sampling design is most commonly used on a longline vessel. As catch size decreases, a simple random sampling design may become more common. You can use either of these designs for a particular set and you can alternate designs between sampled sets to adjust for different situations.

Sampling units on a longline vessel will always be units of gear (one or several segments can comprise a sample unit).



Do not use a random sample design that is not listed unless you contact NMFS first!

Sampling Rules

There are a few rules to keep in mind when determining how you will sample a set:

1. **Number of samples trumps quantity of set sampled:** If there is a possibility that you will only be able to select two sampling units from your frame, reduce your unit size. By reducing unit size in the

sampling frame, you are ensuring that there will be at least three sampled units within the frame. This may mean that you end up taking four samples for a set instead of three because of your starting random sampling unit selection. Always reselect a start point if you have adjusted a frame to accommodate three samples taken systematically (see Figure 8-2 on page 8-7).

2. **Sampling units should be equal in size:** Size discrepancy between all sampling units should be minimized. If the total number of gear segments is not evenly divisible by the number of segments comprising a sample unit, there will be a unit at the end of your sample frame that is smaller than all other units. This is called a hanging unit. *It is critical that units be equal or as close to equal in size as possible, so a rule was developed to deal with this specific case.* You must determine if including the hanging unit onto the previous unit of the frame would cause less of a disruption to unit size than leaving it as a discrete unit. For example, if the hanging unit is comprised of 1 segment and the previous units are comprised of 3 segments, unit size will be more consistent if the last two units are combined. Figure 8-1 shows an example of how to reduce size discrepancy in hanging units.

Spatial Frames on Longliners

When creating a sample frame on a longliner, sampling units must be comprised of whole segments of gear segments. A unit can be one or several segments in length, so long as they are equal.

To sample from a spatial frame, determine the number of segments of gear in a set and decide how much of the set you need to tally. Take into account how long you can stand on deck tallying and on how much bycatch can be stored in the fish collection area when deciding on your unit size. In colder months, or where space is limited, you may want to have fewer segments in your sample unit. On vessels with ample space, you may be able to have larger tally sample units (i.e. more segments per unit).

To create spatial units:

1. Multiply the total number of segments in a set by the fraction you intend to tally. This will give you the total number of segments you need to tally to meet your sample size goal for the set. The observer program

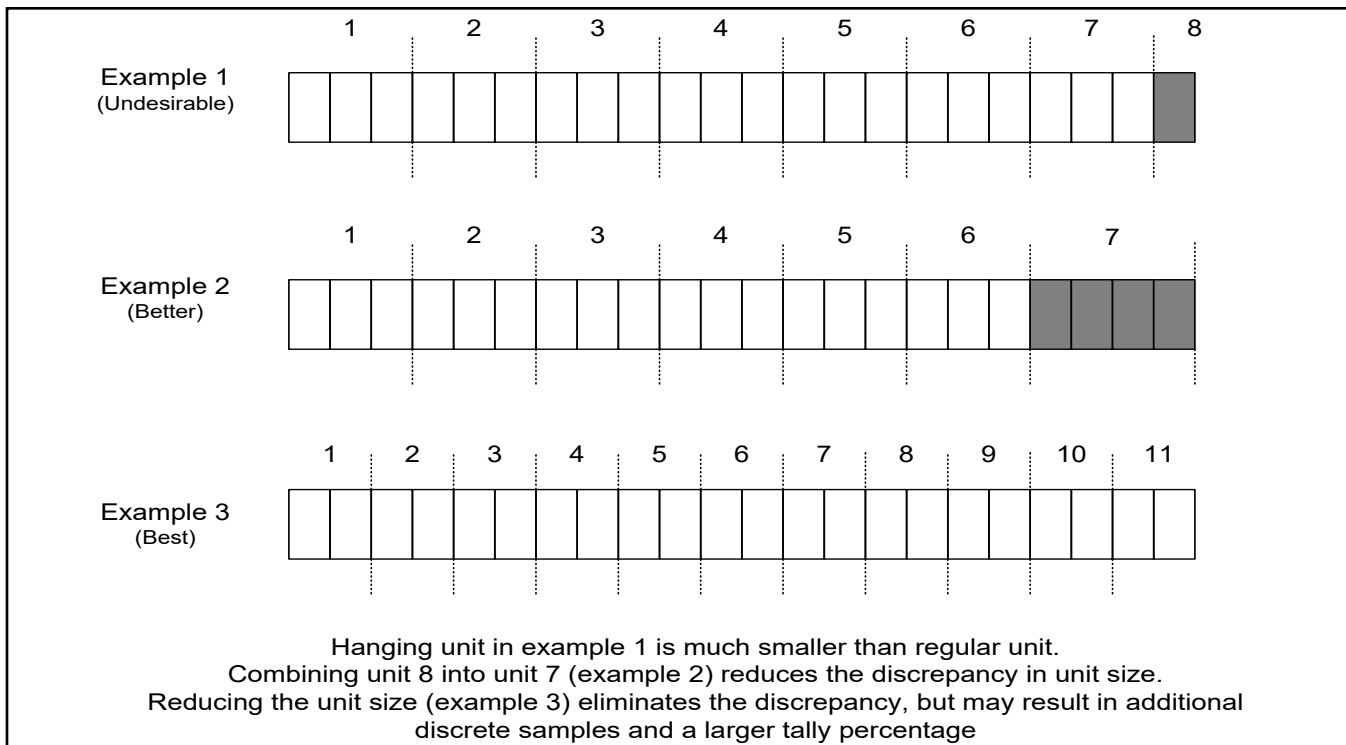

Figure 8-1: Minimizing Size Discrepancy with Hanging Units

expects observers to tally at least 1/3 of a set when it is feasible to do so. For example, if a set is 23 segments and you want to sample 1/3, you need to sample 7.66 segments. You must sample full segments, so you would round this value to 8.

2. Take the total number of segments you need to tally and divide this by the total number of discrete samples you want to collect for the set. If you had to sample 8 segments and wanted to do this over 3 samples, the size of the units would be 2.66 segments per unit. You must tally full segments, so you would round appropriately for a total of 3 segments. This value represents your sample unit size.
3. Divide the total number of segments in the set by the number of segments in a unit. This gives you the total number of sampling units in the set.
4. To complete your sampling design, use the random number table (RNT), dice, slips of paper, or another random method to select your sampling units or a start unit to tally sample. This will be dependent on whether you are using a simple spatial or a systematic spatial design. Document the random selection method in your logbook.

Systematic Sample Designs on Longliners

A systematic design is one in which samples are equally spaced throughout the population. For your sampling design, keep in mind that at least three samples per set are preferred.

Systematic sampling is the preferred sampling method on longliners.

Spatial Based Systematic Sampling Design:

1. Multiply the total segments of gear by the fraction of the set you can tally. Observers are usually able to sample a total of 1/3 of a set. The resulting value is the number of segments you need to tally to meet your total sample size goal for the set.
2. Divide this value by the number of tally samples you intend to take. The resulting value represents the size of one sampling unit. On longliners, the smallest a spatial unit can be is one segment.
3. Divide the total number of segments in the set by the # of segments in one sample unit. This will give you the total number of units in the longline set.
4. Number the units in the set consecutively.
5. Systematic sampling requires that you sample

throughout the entire set at equal intervals from a random start point. To determine the start sampling unit the set, refer to the sampling fraction you chose in step one. The sampling fraction represents the sampling interval i for the set. For every i , you must tally one full sampling unit. If i is 3 (1/3 of the set), randomly choose a number between 1 and 3. This random number represents the first unit you will sample from your frame. For example, i is 3, you would randomly select a number between 1-3. If the random number chosen is 2, you would begin your systematic sampling at unit 2.

unit was 2, and sampling fraction is 3, sampling would occur every 3 units from the random start unit: 2, 5, 8, 11, etc.

Once you have a sample design for the set, determine if there is a chance you will get only two samples for the set. To do this, map out the sampling sequence when you choose the last number in interval i as your start point. If this sampling sequence gives you only two samples for the set, reduce your sampling unit size by one or more segments if possible, recalculate the number of units in the set and select new sample units. For an example see Figure 8-2.

- From the random start point determined in step 5, sample at interval i . For example, if the random start

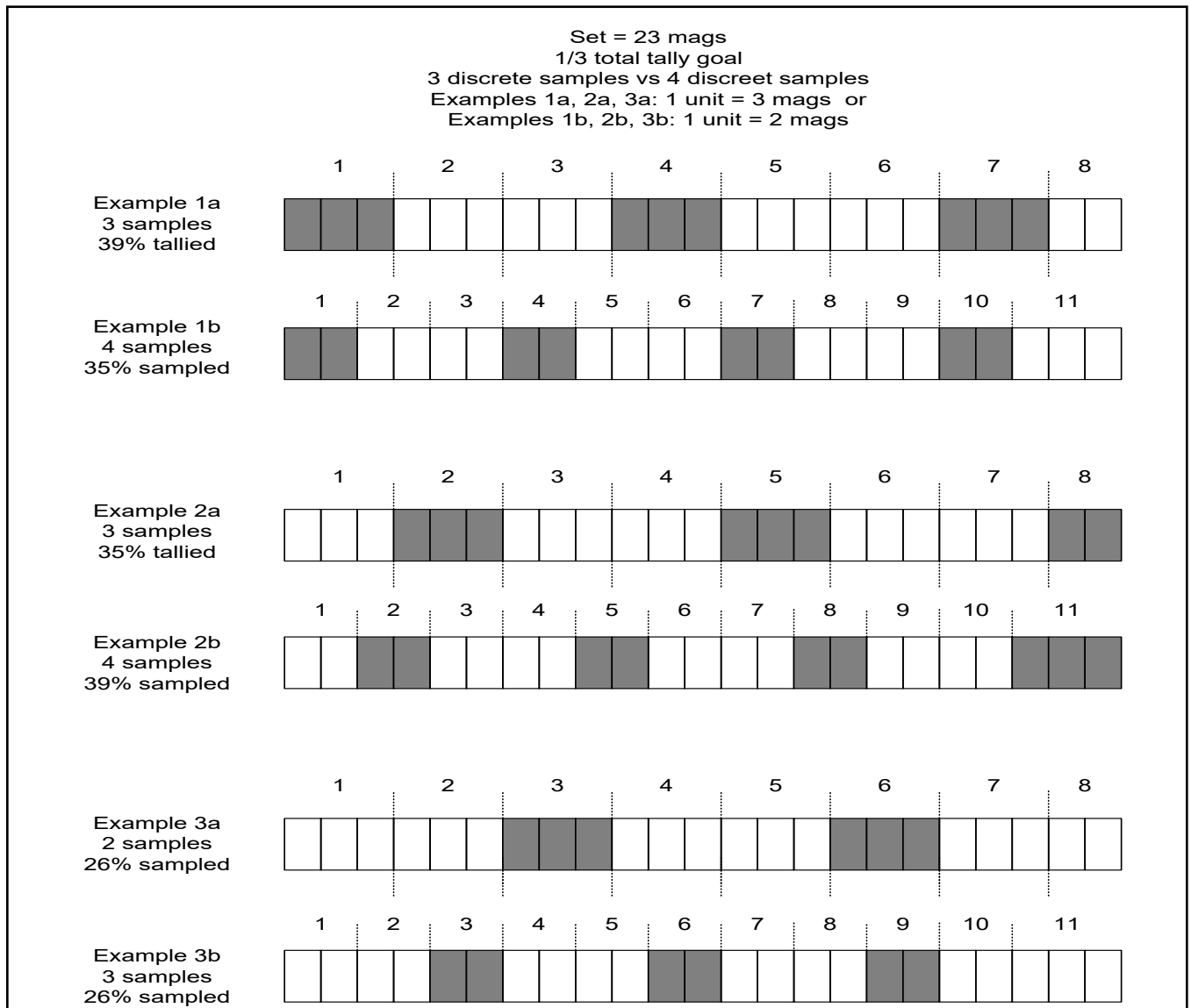

Figure 8-2: Systematic Random Sampling from a Spatial Frame

EXAMPLE: For this example, using steps 1-6 described above, consider an 18 segment set and the observer plans to sample 1/3 of the haul:

1. Determine the # of units to tally: $18 \text{ segments} \times \frac{1}{3} = 6 \text{ segments}$
2. Determine the sample unit size: $6 \text{ segments} / 3 \text{ samples} = 2 \text{ segments per sample}$. This is the sampling unit.
3. Determine # of units in the haul: $18 \text{ segments} / 2 \text{ segments per sample unit} = 9 \text{ sample units in the haul}$
4. List your sample units: You now have units numbered 1-9 (each unit consisting of 2 segments of gear)
5. Determine the sample interval: Because 1/3 of the set is the desired sample fraction, 3 units will be the sample interval.
6. Determine the start unit: A random start unit of 1, 2, or 3 will be selected, and then every 3rd unit after the starting unit will be sampled for species composition. Random #1 is selected so units 1, 4, and 7 will be sampled. In the 18 segment set these units will be segments 1-2, 7-8, and 13-14.

Gear Based Simple Random Design:

A simple random design should be used when it is not possible to collect multiple samples. Collecting a single sample may be necessary if the set is short and/or time and space are limiting factors. The steps to follow when creating a Simple Random Design are the same as described above for a Systematic Sample Design. The main difference is that once the units are numbered, you will randomly select only one sampling unit. An example of simple random sampling from a spatial frame is illustrated in Figure 8-3.

1. Determine the # of units to tally: $6 \text{ segments} \times \frac{1}{3} = 2 \text{ segments}$.
2. Determine the sample unit size: Since you will be collecting only one sample, the unit size has already been determined in step 1.
3. Determine # of units in the haul: $6 \text{ segments} \div 2 \text{ segments per sample unit} = 3 \text{ sampling units in the haul}$.
4. List your sample units: You now have units numbered 1-3 (each unit consisting of 2 segments of gear).

5. No sample interval needs to be determined for a Longliner Simple Random Design.
6. Randomly select the sampling unit: there are 3 units in your frame. Random # 2 is selected and this is your single sampling unit for species composition.



Systematic is always the preferred sampling method. If you have a sampling situation that requires a simple random design document the circumstances thoroughly in your Daily Notes.

Selecting the Start Sample Unit

Longline vessel sample units are always gear based. When sampling longline gear you will need to count segments during retrieval in order to know when to collect your samples. For smaller sets (~20 segments) you should have little problem tracking gear by counting segments by mag, rail, tub, or skate. You may also be on deck for much of the haul and be able to visually count segments as they are hauled in order to work through your design.

You will develop a feel for the hauling speed of the vessel and can use time to estimate when you will have to be back at the rail to tally your composition sample. However, on larger sets consisting of many segments of gear per haul, you may have trouble tracking or verifying segments as they are hauled. If this is the case you may use the estimate of time to retrieve a segment to work through your design.

For example, you are sampling a 54 segment set with 9 sampling units. Each unit is 6 segments of gear. If it takes approximately 6 minutes to retrieve a segment then one sample unit will take approximately 36 minutes. You randomly select unit 2 as your starting unit (segments 7-12). You will need to know when segment #7 (the start of unit 2) comes aboard. The 6 segments in unit 1 will take approximately 36 minutes to haul. Keep in mind you need to sample starting on segment 7, not at minute 36. Once sample 1 is complete, sample 2 will be collected approximately 72 minutes later (the approximate time for units 3 and 4 to be hauled).

Always wait until the start of a segment to start your sample!

Closely monitor the retrieval speed and time and communicate with the wheelhouse in order to start sampling as closely to the correct segment as possible. Because time is used to determine approximately when to collect your sample, you may at anytime adjust the

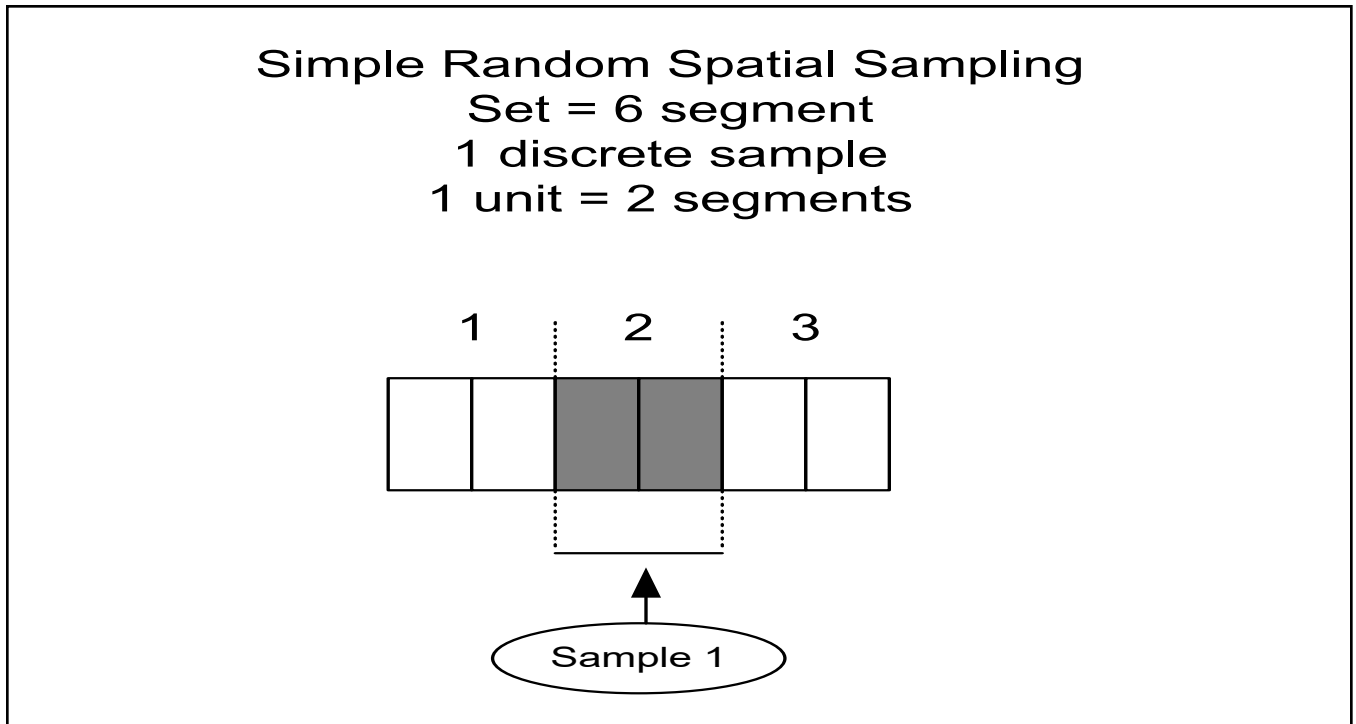

Figure 8-3: Simple Random Sample from a Spatial Frame

time per segment as the retrieval speed changes. If you miss your pre-selected sample start, document this and continue to sample your entire sample unit. You must always sample the entire predetermined unit, even if you do not start your sample at the desired segment.



Do not start or stop tallying in the middle of a segment!

Addressing Challenging Sampling Situations

On rare occasions you may not be able to sample the entire originally chosen sample unit or be able to follow your intended sample design. *Record the sample design code and sample unit type on the Observer Haul Form that best describes the method you used to sample.* If for any reason you abort or alter a sampling design during the sampling of a haul document the circumstances in your observer logbook.

TALLY COMPOSITION SAMPLES

Tallying everything that comes up on a hook is the most critical aspect of longline composition sampling. Tallying all organisms is required for all longliners regardless of the size of the vessel or the target fishery. During the longline tally period you count everything the vessel caught that

you observe during the longline retrieval process. In this phase of sampling you obtain the *number* of organisms occurring in your sample. Resource managers determine the amount of fish caught by extrapolating tally data up to the entire set. If the organisms were not accurately tallied, the data are not accurate and the fisheries management process is negatively affected. Your tally includes all items caught whether or not they were brought on board, including fish, invertebrates, crab pots, trash, rocks and other miscellaneous items. Remember, *your tally data is the raw data*, and the data recorded in your species composition must always reflect that. *Your tally is your sample!*



Count everything that comes up on a hook during each tally period including drop-offs, organisms that were “horned off” prior to coming on board, and miscellaneous items like invertebrates and trash!

It is important to note that it is unacceptable to adjust your tally data to match what was saved for you by the rollerman! For instructions on dealing with these instances see “Discrepancies Between Tally and Weight Samples” on page 8-19.



Check the functionality of your thumb counters daily and oil your thumb counters on a regular basis.

Method for Tallying Predominant Species

Most observers use thumb counters to tally the most abundant species and use the blank space provided on the Deck Form to tally all other species. *You must record the thumb counter tally number on the Deck Form when the sample is completed.* If the gear is retrieved slowly, you may be able to tally empty hooks as well, but because you typically use an average hook value to calculate sampled hooks and total hooks, you don't really need to count empty hooks (unless in the snap-gear fishery).

Species predominance will change depending on the area and depth fished. At the beginning of your trip, or when you travel to a new fishing area, ask the crew what species they believe will be predominant in the catch. You can get an idea of the predominant species for the set during your first sample. It is important to identify the predominant species as this affects subsequent sampling decisions. However, predominance can change within a haul and between samples, so you should be prepared to reassign thumb counters as appropriate to tally the predominant species. Predominance is determined by using a visual count or weight estimate at the sample level. This means you may associate a different species to each tally sample.

Method for Tallying Non-Predominant Species

Non-predominant catch is also counted during the tally period, but it is not practical or even possible to have a thumb counter for every species that is caught. For each sample, use spaces provided on the Deck Form to keep track of these less abundant species (please see the figures containing composition data examples starting on page 8-32). Create columns or rows for every species or species group observed and make a tally mark in the appropriate space each time you observe that species. There are some rules pertaining to the level to which you can identify certain groups and species of fish on the line. These are discussed under "Species Identification Rules" on page 8-12.

Method for Tallying Drop-Offs and Discarded Species at the Rail for Retained Species

A vessel will retain various species depending on what markets they have developed. Often only the target

species are retained, but vessels may also retain some or all of certain non-predominant or non-target species. Fisheries managers consider any fish that is caught on the longline to be removed from the resource. For this reason you must include any fish captured by the longline in your composition data, even if the fish drops off the hook before reaching the vessel or is discarded at the rail by the rollerman. On the Deck Form all retained species must have two tally records in the raw data:

- The first tally includes everything landed, drop-offs, and individuals discarded at the rail for that retained species.
- The second tally only includes drop-offs and individuals discarded at the rail for that species. Both tallies are used to calculate the percent retained for retained species on longline vessels. Be sure that both tallies are clearly documented on your Deck Form. See "Estimating Percent Retained" on page 8-21.

An example of recording tallies (raw data) for retained species is on Figure 8-4. Notice how drop-offs and fish discarded at the rail are included in the final circled tallies. For additional examples of how to record drop-offs and organisms discarded at the rail for retained species, see the Deck Form examples starting on page 8-32.

| DECK FORM | | | | | | | | | |
|-----------|-------------------------------------|---------------|-----------------------|-------------------------------------|--|--|-----------------------|--|--|
| Date | Cruise | Permit | Haul No. | Offload No. | Page <u>1</u> of <u> </u> for Vessel/Plant | | | | |
| 1/13/23 | 23619 | 7700 | 6 | | Page <u> </u> of <u> </u> for Haul/Offload | | | | |
| Sample #: | 1 | Sub-Sample #: | | Sample Size: | 3.0 | <small>Big Sawtooth Jaws</small> | # of Sampled Hooks: | | |
| Presorted | <input type="radio"/> | Combined | <input type="radio"/> | Unable to Follow Design | <input type="radio"/> | No Fish in Sample | <input type="radio"/> | | |
| Species | Sex | # | Weight | % ret. | <small>Length, viability, injury, specimen, tally data, measurements, bird observations, sample design, notes:</small> | | | | |
| KEYPUNCH | <input checked="" type="checkbox"/> | | | <input checked="" type="checkbox"/> | | | | | |
| PCod | | 346 | 0 | | P.Cod - (346) D/O - <input type="checkbox"/> = 4 | | | | |
| Pollock | | 13 | 0 | | Pollock - (19) D/O - <input checked="" type="checkbox"/> = 5 | | | | |
| Pollock | | 6 | 4.7 | | | | | | |

Figure 8-4: Raw Data For Retained Species and Drop-Offs

Method for Tallying Halibut

Halibut are easy to identify on the line and can be tallied to species. The method used for determining the weight of halibut in a sample is different from that for other species. The weight of a halibut in your sample is determined by applying a standard weight to that fish based on its estimated length. This means that you must estimate a length for every halibut in your tally period. Weights are then obtained using the estimated lengths in the "Halibut Worksheet" in ATLAS.



In addition to being tallied, the length of halibut must be estimated. Unlike other species, weights of halibut in the tally period are derived from estimated lengths, not actual weights.

The species composition raw data examples at the end of this chapter show the commonly used technique for recording halibut data within your tally sample. In the example, a range of size categories are listed in 10 centimeter increments. As halibut are observed on the line, make a visual estimate of the length of each halibut and place a tick mark next to the appropriate size category.

The following suggestions will help you estimate the length of halibut:

- Measure the distance from the roller to weld marks on the side of the vessel or the waterline, if weather permits.
- Measure the distance between the gangions on the groundline and measure the length of the gangions themselves. On most longline vessels, the distance between the gangions and the lengths of the gangions are consistent. Under normal operations, you will be able to see the fish being pulled by the groundline and gangion. Estimate the length of the halibut, in reference to the length of the groundline between the gangions, or the length of the gangion itself.
- Use the length of the gaff or the pole gaff to compare to the lengths of the halibut.
- Pre-measure the length of the longline trough. Some halibut will be brought on board either to be retained or by accident. Having several marked measurements in the trough will allow you to quickly estimate length of the landed halibut.
- Some IFQ vessels have permanent marks on the trough to obtain actual measurements for their retained halibut. These marks are usually in inches rather than centimeters. To use these marks for reference you must independently verify the marks in centimeters and it is expected that all estimates are made in centimeters. Do not use the vessels length/weight table in inches to determine your halibut weights. Only halibut length estimates made in centimeters can be utilized with the “Halibut Worksheet” in ATLAS.

All methods and reference marks used to estimate halibut lengths must be documented in the vessel diagram and Daily Notes sections of your logbook.

Test and refine your halibut length estimates. Practice visually estimating halibut landed for injury assessments before you obtain their actual length. Calibrate yourself by comparing your estimates to the actual measurements. With experience, you will become proficient at estimating halibut measurements and knowing which methods work for you in different situations.

After sampling a set, use the “Halibut Worksheet” in ATLAS to determine the proper weight of estimated length groupings. Enter the number of halibut at each estimated length into the table. The worksheet will calculate and provide a total weight of halibut in your tally sample. The weight you obtain using this method is reported in the tally sample data. Refer to the Halibut Worksheet (page 18-13).

Method for Tallying Depredated Items

Whale depredation is the most common form of marine mammal interaction observed in the North Pacific. Orcas and sperm whales have been observed feeding on catch from longline gear in both the Bering Sea and Gulf of Alaska.

Sometimes, marine mammal depredation is evidenced by hooks with fish lips or partial body parts remaining from the original whole fish. It is important that you tally these items, because they represent fish that were caught. Other signs of whale depredation include 1) raked carcasses and/or 2) whales diving on the longline. For a more detailed explanation on marine mammals feeding on the catch see page 14-2.



To the best of your ability determine what species the lips or other remaining parts belonged to. Make tally marks for a pair of lips or other body part as you would a whole fish. Typically, whales are interested in turbot and Sablefish so if your vessel is fishing for one of these species left over parts from depredation likely belong to individuals from one of these species. Include the tally number for depredated items with the rest of the tally data reported for the species. If you are unable to identify a fish to species or group using just the

LONGLINE COMPOSITION SAMPLING : SPECIES IDENTIFICATION RULES

head or lips left on the hook include these animals as “unidentified fish” in your tally sample.

When marine mammal depredation occurs this should be documented in your logbook on a set by set basis.

Important issues to address are:

- How many marine mammals did you see around the line and what were the behaviors you witnessed?
- How much of your tally sample was made up of gear containing “preyed upon” fish?
- What is your estimate of how much of the total line had depredation (*i.e.*, were whales feeding from the line only before, during or after your tally or were they consistently feeding throughout the line)?
- How egregious was the depredation (*i.e.*, were whales taking only a few fish, were lots of heads left on the hooks for you totally or was the line just empty, etc.)?
- How do you feel about the data you collected? Do you feel that it closely represented the true catch, or did the depredation severely affect the composition?

All marine mammal interactions must be documented on the Marine Mammal Interaction and Specimen Form; see “Marine Mammal Interactions” on page 14-2.

Mammal depredation should be recorded using the appropriate gear performance code on the Vessel Haul Form; see “Gear Performance” on page 7-19.

Method for Tallying Fish Consumed by Sandfleas

Sandflea predation is common with fish caught by longline gear. *Fish that have suffered from sandflea predation must be tallied to species or appropriate group code along with all fish of that species.* Halibut lengths may still be estimated. Do not include fish with major sandflea predation in your weight samples as the weight of the fish may be altered by the predation.

Method for Tallying Fish Waste and Decomposed Fish

Fish waste and decomposed fish are rarely used on longline vessels. Fish waste is considered anything caught by a hook that was previously processed by a vessel. An example of this would be a fish head that was clearly cut by a machine. Fish waste must be tallied with a corresponding weight. Decomposed fish (code 899) are those organisms in an obvious state of decomposition,

with a breakdown of muscle and skin. Decomposed fish must be tallied to species or group since it was caught on the line. If you cannot identify the fish to those levels, record it as fish unidentified with an actual number and a weight of 0.

Method for Tallying Pieces of Miscellaneous Items

The database does not accept decimal values for number of individuals. For this reason, observers must use the nearest whole number appropriate for fish and/or invertebrate pieces.

With the exception of depredated or sandflea eaten items, observers infrequently may encounter pieces of items on a longline. On the rare occasion that you do encounter a partial organism, tally it as one animal. For example, if one king crab claw comes up during the tally period, record this item as “1” in the number field.

Crab Pots and Large Items

Occasionally large items (such as crab pots or 55 gallon drums) are caught by longline vessels. These items must be tallied as miscellaneous unidentified (code 900) with an actual number and a weight of 0.

Conjoined Items

When conjoined items (*e.g.* sea anemone on a rock) are encountered in your tally sample, you must tally each of items separately. If the conjoined item ends up in your weight sample, separate the two items and count and weigh them separately. If you are unable to separate the two items, *do not weigh them together*. In this case you would list each item separately with a actual count and a weight of zero. Document the situation in your Daily Notes.

Marine Mammals

Marine mammals or marine mammal parts (*i.e.* bones, baleen) caught by longliners are never tallied nor are they included in the species composition. This information must be documented on the Marine Mammal Interaction and Specimen Form.

SPECIES IDENTIFICATION RULES

Ideally, you could collect all bycatch organisms from within the tally session. With space on longliners often limited and numbers of fish potentially high, it is more often the case that a small portion of tallied bycatch is

collected. This means there will be many organisms that you never get to see up close and in hand.

Many species are quite distinguishable from others. Once you become familiar with them, they can be tallied and identified on the line to species with minimal difficulty. Not having the fish in hand is only a problem for those groups of species that are too morphologically similar to be reliably identified on the line. These individuals must be accounted for in a very specific way.

For these fish, you will tally individuals at the appropriate group code while collecting a subset for identification to species. For individuals tallied at the group code level, you may identify to species only those you have in hand. This process will be necessary for such morphologically similar fish as Arrowtooth and Kamchatka Flounder (Arrowtooth/Kamchatka group), Northern and Southern Rock Sole (rock sole unidentified group), Shortraker and Rougheye Rockfish (Shortraker/Rougheye group), Bairdi and Opilio Tanner crabs (Unidentified Tanner crabs group), Red, Blue and Brown King crab (unidentified king crab group), certain sculpin species, and the *Bathyraja* skates.

You should strive to identify organisms to the most accurate category possible *or allowable*. There may be occasions when you need to identify some flatfish as just “flatfish unidentified,” and some roundfish as just “roundfish unidentified.” *If you use fish unidentified (901), flatfish unidentified (100), rockfish unidentified (300), or roundfish unidentified (200), please contact NMFS!*

Tallying Miscellaneous Invertebrates and Items

Observers are expected to tally everything they see during their tally sample periods, even non-prohibited miscellaneous invertebrates, rocks, and trash! Tally invertebrates to group code or to species as appropriate. Reference your species identification guide(s) to determine the levels to which the observer program expects invertebrates to be identified.

Tallying the *Raja* and *Bathyraja* Skates

The two *Raja* skate species you may encounter are relatively easy to differentiate from each other and the *Bathyraja* group. Because of this, the Observer Program allows observers to tally the *Raja* skates to species on the line. The two *Raja* skates you can tally to species are:

- *Longnose Skate*

- *Big Skate*

If you are unable to differentiate Longnose Skates from Big Skates on the line, use the category *stiff snout skate* (*Raja* sp., code 167) for these animals.

*All the other skate species you will see fall into the soft snout skate (*Bathyraja* sp., code 159) group.* The Observer Program does not allow observers to identify *Bathyraja* skates further to species without the skate in hand. *This means that you cannot differentiate to species those *Bathyraja* skates during your tally period that were not collected.* Use the *Bathyraja* sp (code 159-soft snout) for any *Bathyraja* skates not identified to species in hand.

If you are unable to differentiate *Bathyraja* skates from *Raja* skates on the line, then you must use the skate unidentified code (code 90) for all tallied skates. Contact your inseason advisor as soon as possible about this problem.

Tallying Sculpins

There are two sculpin species groups and one sculpin species that can be identified on the line while tallying. They are:

- *Irish lord unidentified*
- *Myoxocephalus unidentified*
- *Bigmouth Sculpin*

If the sculpin that you are seeing during the tally period do not fall into one of these categories, you must tally them as *sculpin unidentified* (code 400-Cottidae sp.). Specimens that you collected during your tally periods can be identified further to species when you have them in hand.

Tallying the Kamchatka/Arrowtooth Flounder Complex

Kamchatka and Arrowtooth Flounder are too similar in appearance to be tallied to species on the line. For this group, individuals in the tally sample period are tallied as code 149 or “Kamchatka/Arrowtooth.” Specimens that you collected during your tally periods can be identified further to species when you have them in hand.

Greenland Turbot can be confused and incorrectly tallied on the line as Kamchatka/Arrowtooth. *If you encounter turbot in your weight sample, and you did not tally turbot, it may have been tallied as a Kamchatka/Arrowtooth.* See “Discrepancies between tally and

weight samples" on page 8-19 for instructions on how to record these data and contact your inseason advisor for additional guidance.

Tallying the Northern/Southern Rock Sole Complex

Northern and Southern Rock Sole are too similar in appearance to be tallied to species on the line. For this group, individuals in the tally sample period are tallied as code 104 or "rock sole unidentified." Specimens that you collected during your tally periods can be identified further to species when you have them in hand.

Tallying the Tanner Crab and King Crab Complex

Individuals within the Tanner crab group and king crab group are too similar in appearance to be tallied to species on the line. For these two groupings, individuals in the tally sample period are tallied by their respective group - either code 3 for "Tanner crab unidentified" or code 2 for "king crab unidentified." Specimens that you collected during your tally periods can be identified further to species when you have them in hand.

Tallying the Shortraker/Rougheye Rockfish Complex

For the Shortraker/Rougheye complex, both rockfish species in the tally sample period must be tallied as code 354 (Shortraker/Rougheye unidentified). Specimens collected during the tally period must be identified to species once in hand.

Observers are asked to take the following additional information on Shortraker and Rougheye species:

- Collect 30-40 Shortraker/Rougheye Rockfish *per haul from within your tally sample*.
- Identify these fish in hand to species.
- Weigh these fish by species and report them in your longline sample along with any other fish collected for the sample.
- Collect sexed lengths and otoliths according to the priority lists starting on page 13-24.

You may choose to collect sex/length and otolith data from additional individuals outside your tally sample periods. If you do so, these data must be reported as subsample data.

Bycatch of Shortraker and Rougheye Rockfish is often high on Sablefish vessels, and you should be able to collect 30-40 fish from within your samples on many sampled sets.

Specimens that you collected during your tally periods can be taken further to species when you have them in hand.

Tallying Other Similar Species

The following species can be confused with other similar species that do not occur with nearly the same frequency. The fish in the list below should be identified to species during the tally period. Spot check your subset fish for the more rare, similar species. For subset collection protocols see "Subset Sampling for Non-Predominant Species" on page 8-16.



If these individuals are the predominant species, you must collect 60 total fish for your weight samples for the set.

The occurrence of one of the similar species is a good indicator that there might be more within the haul. If you do get one of the more rare similar species in the subset sample, you must do the following:

- **Flathead Sole:** spot check for Petrale Sole and Bering Flounder. If one or more of the similar species occur in the subset, continue tallying as flatfish unidentified (code 100) for the rest of the haul even if you do not find any more rare species in subsequent samples. Identify to species all individuals in the subset sample.
- **Shortspine Thornyhead:** spot check for Longspine Thornyhead. If one or more of the similar species occur in the subset, continue tallying as thornyhead rockfish unidentified (code 349) for the rest of the haul even if you do not find any more rare species in subsequent samples. Identify to species all individuals in the subset sample.
- **Giant Grenadier:** spot check for grenadier unidentified. If one or more of the similar species occur in the subset, continue tallying as grenadier unidentified (code 80) for the rest of the haul even if you do not find any more rare species in subsequent samples. Identify to species all individuals in the subset sample.

Follow these guidelines for the sample in which the less common species was found and for all subsequent samples within that haul. When this happens, collect

as many individuals of the group code you see to minimize the use of the unidentified group code within your composition sample. Also, if you suspect you will encounter some of the less common species (i.e. different area, tally observations, etc.), collect more subset fish.

Return to tallying Flathead Sole, Shortspine Thornyhead, and Giant Grenadier on the following sampled hauls until you see the less common similar species.

Tallying Seabirds

All seabirds caught on a hook during your tally period must be tallied, regardless of whether they are dead or alive. This means that you tally seabirds caught on the surface, as the gear was retrieved, as well as those that were caught as the gear was deployed (i.e. that are dead). *NMFS requires the crew to retain all seabirds retrieved during an observer's tally period for the purposes of species identification. Remind the rollerman to keep any seabirds during the tally period.* Tally any seabirds not landed only to the level you feel confident. Keep in mind that you will have to verbally describe at your debriefing any seabirds taken to species during your cruise!

If the crew is not keeping seabirds for you, inform the captain and NMFS of this problem. For detailed duties regarding seabirds, see "BIRD SIGHTINGS AND INTERACTIONS" on page 16-1.

Tallying Corals

Corals are marine invertebrates that typically live in compact colonies of many individual polyps. When you encounter coral in your species composition, the coral should be identified and separated to order using the Corals guide in the Species ID Manual provided. The six major groups of coral in the ID guide include: Hydrocorals, Stony Corals, Gorgonians, Black Corals, Soft Corals, and Sea Pens and Sea Whips. If you are unable to identify the coral, list it as coral unidentified and collect a specimen or take photos with the haul/sample number in them. Specimens should also be collected whenever you encounter a new group of coral. These specimens will be reviewed during the debriefing process.

Corals on the line must be tallied as coral unidentified (except for sea pens/sea whips). *Record each instance of coral on a hook as a single individual.* If the coral is retained and a weight is obtained, include only the single coral and its associated weight. This may result in multiple weight entries for the same order. Do not group

corals together even when they are within the same order. If you are unable to distinguish individual coral in your bycatch collection, do not record a weight. Leave the weight field blank with the appropriate tally number. For an example see Figure 8-7 on page 8-33.

Tally Visibility Challenges

On longline vessels it is critical that the line is visible to the observer from the tally station while counting organisms during retrieval. It is expected that the line can be seen from where it exits the water to where it comes aboard the vessel and fish are removed.

Due to deck set-up and operating conditions, on some small longline vessels, the line may be obscured by the rollerman, other crew, or the vessel. In these situations you should:

- Move to an area that is not obscured, and/or
- Work with the crew to gain a clear site path. It may be that you only need to move out of the way at certain times if at all, and
- Document the hauls, samples and organisms when the line was obscured so that your data can be evaluated during debriefing.
- Ask the crew to inform you of the drop-offs when they occur and spot check their IDs when possible.
 - Keep these crew reported fish tallied separately from the ones you observed. Document on your Deck Form how certain you are that the species identification is correct.
- Always inform NMFS staff as soon as possible of the situation.

Halibut specific tallying instructions are outlined on page 8-25.

WEIGHT SAMPLES

On a longliner you will most likely not be able to weigh every individual that you tally. Weight samples must be collected to determine weights for species composition either as a subset during the tally period or as a subsample before or after the tally period. These weight samples allow resource managers to determine the average weight of a given species. For this reason you must ensure no sorting or bias occurs during the collection of these fish.

Weigh the collected organisms by species. For organisms tallied at the group level, it is important that you identify the weight representatives from these groups to species. The weight and number information you report for these species allows resource managers to determine the proportion of one species to the other in the group level tally data.



Do not weigh partial or depredated fish as part of your weight sample. Weigh only whole fish! Do not include fish with major sandflea predation in your weight samples as the weight of the fish may be altered by the predation.

Subset Sampling for Non-Predominant Species

For non-predominant species you will collect a subset sample for number and weight from within your tally period.

To collect bycatch species while you are tallying, you must ask the rollerman to retain at least 15 individuals of a given species per sampled haul. You will weigh and count these individuals during the non-tally period. It is preferred that you spread this collection equally over your samples for the haul. Inform the rollerman that you will need a certain number of bycatch individuals for a particular species, regardless of size, to be landed. For example, if you are collecting 3 samples for a given set, ask the rollerman to retain the first five individuals of each species encountered during the tally. If you cannot do so, randomly choose one sample from which to take your 15 individuals.



If you are having problems collecting 15 individuals of a given species per sampled haul contact your inseason advisor for additional guidance

Always collect a subset sample for any fish for which you are tallying as a group. Your subset fish should be keyed to species if collected from inside your tally. The rest of the tallied fish are recorded in the sample data under the group code.

For large Longnose Skates and Big Skates, you can use the length/weight table (“Skate Length to Weight Table” on page A-49) to provide a weight in the species composition data if they are too large to weigh and an actual length is obtained. Do not use the length to weight tables for estimated lengths.

Weighed fish from within the tally period are recorded as sample data see Figure 8-7 on page 8-33.



Even though you think the rollerman is doing an excellent job of collecting fish, you must always tally everything, because some fish may be displaced by the rollerman or lost before they can be weighed by you.

Never adjust your tally data to match what the rollerman saved for you. If you encounter more of a species than what you tallied in your bycatch baskets see “Discrepancies Between Tally and Weight Samples” on page 8-19 on how to report this in your species composition.

Determining Halibut Weight in Samples

Vessels are required to release halibut outboard of the railing (see “Careful Release Methods for Halibut” on page 8-21) unless the observer requests halibut to be landed or the vessel is fishing IFQ halibut. For these reasons, observers typically do not collect halibut during the tally period. When halibut are not the predominant species, you are expected to tally them in 10 centimeter increments using a visual estimate of their length and later applying a weight derived from the “Halibut Worksheet” in ATLAS. For more details about estimating halibut lengths during the tally period see “Method for Tallying Halibut” (page 8-10).

The “Halibut Worksheet” in ATLAS is used to calculate the halibut weights based on lengths or estimated lengths (see “Figure 18-26: Halibut Worksheet” on page 18-13 in the ATLAS section of the manual). If you use the Halibut Worksheet, you are required to record these data on your Deck Forms:

- Estimated lengths
- Frequency of each estimated length
- Number and weight totals derived from the Halibut Worksheet

If you do not use the Halibut Worksheet, all raw data and calculations must be documented on your Deck Forms.

The data examples at the end of this chapter show the commonly used technique of recording halibut data within your tally sample and documentation protocol for generating a weight for this species (see Figure 8-7 on page 8-33).

Dealing with Whole Crab Versus Crab Pieces

Document weight data for whole crab only. For our purposes, a crab is considered whole if it is essentially

whole by weight. It is not necessary for a crab to be intact to be considered whole.

If a crab leg(s) is attached to a hook in your tally period it should be counted as an individual. However, a weight should not be recorded as there are not sufficient parts to determine an appropriate weight. Crab legs can potentially be identified to king crab unidentified or Tanner crab unidentified. If you are uncertain of the identification, list the crab leg(s) as crab unidentified with a weight of 0.

If you find that a crab in your subset weight sample that was once whole is now broken and missing a majority of its weight, you may be able to determine the species but *you must not report the weight of these parts.*

Weights that do not represent whole crab are inaccurate from the data user's perspective and negatively impact weight to number relationships otherwise provided by the data.

In summary:

- Tally all crab on the line to the appropriate code.
- Identify all whole crabs in hand to species and report their number and weight.
- Identify crab parts to the best of your ability. Carapaces should be identified to species and legs can usually be identified to the most appropriate genus group code. Do not report the weight of these parts.

Subsamples for Predominant Species

There is usually not enough space to collect and store predominant species for average weights during the tally sample. This is why observers collect predominant species weight samples from outside the tally period. These samples are referred to and recorded as subsample data. Subsample data must have weight and number entries for each species in that subsample. You must also be able to monitor the collection of these fish to ensure no sorting or bias occurs. When collecting your subsample fish, try to do so right before or right after that sample period. This allows statisticians and resource managers to regard these fish as being from the same population as the tally period fish. You must collect at least 60 total individuals of the predominant species per sampled haul. If the predominance based on count or weight changes with each tally period, it is OK to collect about 20 per sample and not end up with 60 of one species.

Spread this collection out over the samples taken within a haul and collect approximately equal numbers of fish for each sample. For example, if you are collecting 3 samples for a given set, collect the first 20 predominant species that come over the rail during each selected non-tally period. The sample most closely associated with these data is the parent sample to that subsample.

When the catch rate is low and you are unable to collect sufficient numbers of the predominant species during a subsample (less than 20 of the predominant per selected subsample unit) observers may be able to collect predominant species during their tally period. In this scenario you must be able to monitor the collection to ensure no sorting or bias occurs.

Do not confuse predominant species with target species. For example, your vessel may be targeting Sablefish, but if they are catching more grenadier than Sablefish, you should be collecting average weight data for 60 grenadier for the haul. However, predominance can change during tally periods within a haul. For this reason, predominance must be determined by sample. This can be done by either a count or weight. Just be consistent. The subsample should be a weight collection for the species that is most abundant during the corresponding tally period. If predominance changes between samples, at least 20 individuals of the predominant species should be collected from each subsequent sample.

Lengths and specimens collected from your *subsample should be recorded on your Length and Specimen Form with a sample design code 9- "Other Random."* See "Sample Design" on page 13-16 for more details.

In the database, a subsample must be linked to its parent sample. To accommodate this, there is a numbering convention designed specifically for subsamples. This subsampling numbering convention is discussed on page 8-27.



Be sure to account for the biases discussed earlier in this section. If the weight data is skewed because you are only getting big fish or small fish, crucial management decisions are being based on faulty, inaccurate information. This can be harmful to the fishery!

When Halibut is the Predominant Species

It is preferred that halibut weight be obtained by using the "Halibut Worksheet" in ATLAS with the estimated

lengths of all tallied halibut. See Figure 8-4 on page 8-10 for an example of recording tallies and drop-offs. See Figure 8-7 on page 8-33 for an example of tallying and recording halibut within your sample.

When halibut are the predominant species (e.g., on vessels fishing IFQ halibut) it may be difficult to keep up with a tally by estimated lengths. If you are unable to estimate the length of each halibut in your tally, there is an alternate, less preferred method of obtaining weight data for these halibut. This method requires that you tally all halibut from within your sample and actually weigh a randomly selected group of individuals, just as you do for all other species.



Only one of these approved methods should be used to determine the weight of halibut within the same species composition sample.

You should only use this less preferred option if you are catching a great deal of halibut or if you are unable to accurately estimate the length of the halibut caught. Management still needs to calculate the total weight of halibut caught, so you absolutely must tally all the halibut in your samples! If you decide to use a weight collection, you will need to randomly collect at least 7-10 halibut per sample (or 20 - 30 halibut per set). Collect these individuals during a non-tally sample unit that is as close, spatially, to a sampled unit as possible. This unit can either be before or after the tally period. *Report the number and actual weight of these halibut as subsample data. Report the number of halibut tallied as sample data with a zero entry for weight.*

For those halibut that are far too large to weigh, you may measure the halibut and use this length with the “Halibut Worksheet” in ATLAS to get their weight.

SAMPLE BIAS

Many longline catcher processors have incline belts that take fish from a trough in the roller station to a holding bin or processing machine in the factory. Incline belts can be a source of bias: larger fish may not make it up the incline belt at the same rate as smaller fish or visa versa. When collecting fish for weights and biological data, be sure to monitor for size bias and minimize this bias as much as you can. Often you can minimize or eliminate bias by collecting fish before the incline belt. If you cannot avoid the incline belt, be sure to *clear all fish* in front of the incline before and after you collect your

subsample fish. In the event you have problems clearing the belt or cannot separate your subsample fish from other fish, contact your inseason advisor.

If the vessel is retaining skate species, make sure that your weight sample of these organisms is not coming from only the retained skates. Crew tend to toss out skates that are too small to make into product, potentially biasing your sample and the data.

If the crew is collecting fish for you, make sure they are not size selecting them. Discuss your needs with crew so that they know that you want a random sample with no size bias. Sometimes crew members will sort fish for processing, not realizing that this activity is negatively affecting your sample.

RECORDING SUBSET AND TALLY DATA IN SPECIES COMPOSITION.

Weight and tally data are reported together in species composition. After the tally period is completed, weigh the bycatch that was saved by the rollerman. First, record the number and weight of these subset individuals. Next, subtract the number of subset organisms from the total tally number for that species or species group. The remaining tally number will then be recorded with a weight of zero at the appropriate species or species group level which it was tallied at. The total number of organisms you report in your species composition data (species composition “#” keypunch) for a sample should be the same as the total number of organisms you tallied (tally keypunch).

Example: Sample 2, you tallied 151 Pacific Cod, 8 pollock and 9 Kamchatka/Arrowtooth. The rollerman saved you 5 pollock and 5 Arrowtooth flounder during the tally period. Count and weigh these and record them on the left side of the Deck Form. Then subtract the # of individuals from the total number you tallied for that species or species group and record the remaining individuals which were not saved and report them with a weight of zero on a separate line.

- 151 Pacific Cod tallied - 0 Pacific Cod saved = 151 Pacific Cod tallied but not saved
- 8 pollock tallied - 5 pollock saved and weighed = 3 pollock tallied but not saved
- 9 Kamchatka/Arrowtooth - 5 Arrowtooth saved and weighed = 4 Kam/Arrow tallied but not saved

See Figure 8-5 for an example of recording weighed and tallied organisms.

See the Deck Form examples at the end of this chapter for examples of how to document composition tally data (with no weight) and weight data.



You do not subtract subsample fish from the tallied number of that fish!

| Sample #: 2 | Sub-Sample #: | | Sample Size: | | | % Segments post | # of Sampled Hooks: |
|---------------------------------|-------------------------------------|-----|---|-------------------------------------|--|---|------------------------|
| Presorted <input type="radio"/> | Combined <input type="radio"/> | | Unable to Follow Design <input type="radio"/> | | | No Fish in Sample <input type="radio"/> | |
| Species | Sex | # | Weight | % ret. | Length, viability, injury, specimen, tally data, measurements, bird observations, sample design, notes | | |
| ----- KEYPUNCH ----- | <input checked="" type="checkbox"/> | 168 | 10.82 | <input checked="" type="checkbox"/> | | | |
| P Cod | | 151 | 0 | | P Cod - (151) % L | | |
| Pollock | | 5 | 4.10 | | Pollock - # L (8) % L | | |
| Arrowtooth | | 5 | 6.72 | | | | |
| Kam / Arrow | | 4 | 0 | | | | |
| Pollock | | 3 | 0 | | Kam / Arrow - # □ (9) | | |
| | | | | | | | |
| | | | | | | | |
| | | | | | | | |
| | | | | | | | |
| | | | | | | | |
| | | | | | | | |
| | | | | | | | |
| | | | | | | | |
| | | | | Tally XP | 168 | | |

Figure 8-5: Subset and Tally Data

DISCREPANCIES BETWEEN TALLY AND WEIGHT SAMPLES

There may be instances where the rollerman collects more of a certain species than what you tallied. In this event, always use your tally number in the species composition. Record the number and weight of the given species that the rollerman collected for you in the subsample. For example, if you tallied 7 Flathead Sole, but 9 were encountered in your bycatch baskets, you would record 7 Flathead Sole with a weight of 0 in your species composition. The 9 Flathead Sole, and its associated weight, would be recorded in the subsample. Remember, *your tally data is the raw data*, and the data recorded in your species composition must always reflect that. *Your tally is your sample!*

There may be instances where the rollerman collects a species that you did not tally. For example, during sample 1, you tally 15 Yellowfin Sole and 0 rock sole. You have good communication with both the rollerman and the bleeder for bycatch collection and have asked that 5 of the Yellowfin Sole be collected for your weight sample. You have a clear line of sight to the bleeder and can see that he is collecting the appropriate bycatch. Upon

identifying and weighing the individuals in the bycatch baskets you identify 3 Yellowfin Sole and 2 Northern Rock Sole. Both the 3 Yellowfin, and its associated weight, and the 2 Northern Rock Sole, and its associated weight, would be recorded in the sample. The remaining 10 flatfish tallied as Yellowfin would be recorded as flatfish unidentified with a weight of 0 in the sample. *Document these occurrences and contact your inseason advisor to discuss your specific challenges.*

COMBINED SAMPLES

The only time you combine sample data on a longliner is when you are unable to distinguish the tally data of one sample from another. This would be the case if, for example, you tallied one sample, did not write down the tally numbers for that sample and forgot to reset your clickers for the next sample. The data in this case are still viable, because you have the number of fish caught over a known quantity of gear. To salvage these data, you combine data from the affected samples.

By combining samples into one in the reported data, you are alerting data users to regard these samples separately from intact samples. As with trawlers, you can have a mixture of combined and non-combined samples for a set. You combine only those samples you believe are no longer discrete samples.

On the raw data Deck Form, mark the samples that will be combined by checking the circle next to "Combined" for those samples. The combined samples are reported as one sample in ATLAS. When reporting combined samples, enter the data for all the samples affected under a single sample number.



You do not combine samples when fish collected for weights are mixed between samples. If this happens, report all your weight fish as a subsample to one or the other distinct samples within the haul.

WHEN THERE ARE NO FISH ENCOUNTERED DURING THE SAMPLE

On rare occasions there will be no fish on the line during your tally period. Fisheries managers assess catch per unit effort and data revealing that there were no fish in a sample are just as important as data that relay what and how much fish were caught. Please see Figure 8-8

on page 8-34 for an example on how to record a sample where no fish were encountered.

Remember to Check the “No Fish in Sample” box on the Deck Form and to write “NO FISH” across the body of the sample block.

In ATLAS you simply enter an “N” in the “Species Comp in sample?” box. Please refer to page 18-14 of the ATLAS chapter for information on how to enter these data.

Obtaining Weight Data - Small Vessels

It is recognized that time and space constraints on small vessels will make the collection of weight data challenging. As a result you may have to alter your methods on a haul by haul, sample by sample or day by day basis to adapt to the fishing operations. If possible, you should adhere to the guidelines listed earlier in this section for the requirements of predominant species and bycatch collections.

Some additional guidelines for challenging situations are listed below.

- Weigh all bycatch when possible if there are less than 15 organisms for a given species
 - Common bycatch species subset collections can be spread out between samples to save storage space.
 - Collect weights of rare species at the haul level if missed during the sample.
 - Divide the collection of common species weights between hauls.
- Reduce the total number of predominant species weight collection to a more manageable number to make time to weigh other rare species.
- Due to the close proximity of your tally station and the hauling station, you may be able to collect predominant species during your tally period if space allows.

Do not weigh fish during your tally period when the line is coming on board. During your tally period your attention must be focused on the line coming on board and tallying species on the line.

Dealing with Time and Space Constraints on Longline Vessels

You may find the key to success in challenging sampling situations is to mix up your duties and alternate the number of samples/duties done per haul. When a vessel

deploys small hauls, you may not be able to complete all tasks due to time and space limiting factors. Many longliners, including but not limited to IFQ and snap gear vessels have limited space available for sampling. A time saver when working in close quarters could be how/when you count and weigh bycatch. If you have limited time between samples you can always vary which bycatch species you collect per sample. For example, collect more common species during one sample and rare species during the next sample. For common bycatch species, such as skates, Irish lords, etc., you could collect all 15 of your bycatch species during one sample. During subsequent samples, you now only have to concentrate on the rare bycatch species.

You may also reduce the number of predominant species you collect if time and space become a limiting factor. If weighing 60 specimens per haul is not feasible, reduce it to a more manageable level. The predominant or secondary species can come from the tally sample and recorded in the species composition sample, or from before or after the tally sample and recorded as a subsample. If the bycatch species is rare, you should endeavor to collect all individuals during a tally sample.

In all cases, every effort should be made to ensure that these collections for average weights are done randomly. When collecting fish for average weights, have a predetermined number to stop at before your collection begins. Document the circumstances in your daily notes when you are not able to get at least 15 organisms for average weights or all the organisms if there are less than 15.

The methods you choose may vary from one set to the next depending on your assessment of the haul and gear. Space and time are going to be factors in all of your sampling decisions on these vessels and must be considered in collecting weight samples. It is important to document all your collection methods.

HALIBUT INJURY ASSESSMENTS

The halibut mortality data in the longline fishery come from halibut injury assessment data collected by observers. Injury assessments are evaluations of injuries received by individual halibut incidentally caught on the longline.

Halibut for injury assessments are collected during a randomly chosen non-tally segment. Assessments are made on halibut in hand and using the “Key to Longline

Injury Codes for Pacific Halibut” (see page A-55). Refer to “Halibut Injury Assessments on Longliners” on page 12-8 for more information on injury assessment methods and recording these data. Collect about 10 halibut lengths and injury assessments from every sampled haul.

Careful Release Methods for Halibut

Longline vessels are able to reduce their overall halibut mortality and extend their fishery by carefully releasing halibut. Careful release methods for halibut are simplified by the fact that circle hooks are the most commonly used hook. These hooks almost always hook halibut with the bend of the hook encircling the corner of the jaw, usually on the blind side of the fish. While circle hooks can result in very serious injuries if the hook is ripped out of the fish’s mouth, they facilitate a few careful release methods which cause little or no further damage to the fish.

The following describes NMFS’ careful release regulations for Pacific halibut. The roller men may use any of these methods, or a combination thereof.

- **Cut the gangion:** The roller man cuts the line attaching the hook to the groundline.
- **Careful shaking / twist-and-shake / hook twist method:** The roller man slides the curved end of the gaff hook down the gangion (the line connecting the hook to the mainline) to the hook, engaging the bend of the hook on the curve of the gaff. He maintains tension on the gangion, lifts the end of the gaff and twists it, rolling the hook so that the fish is hanging down on the point of the hook and the hook is supported above the location where the fish is pierced. He gently shakes the gaff to make the fish fall off the hook.
- **Hook Straightening:** The roller man slides the curved end of the gaff down the gangion to engage the bend of the hook on the curve of the gaff. As the gangion is drawn up and past the roller, he brings the gaff against the outside of the roller. Holding the gaff firmly, the hook will straighten against the curve of the gaff, pull out of the jaw of the fish and straighten. This technique is only possible with the smaller hooks more common in Pacific Cod and Sablefish fisheries.

Careful shaking/twist-and-shake/hook twisting and hook straightening are learned techniques that work very well when performed properly. Shaking can be done just about as easily inboard and over the rail, so landing a fish for you should not be a problem. Many

vessels use the hook straightening technique although it is more difficult for the roller man to land the halibut inboard. If your vessel uses hook straightening work with the captain and the crew to find a method for these halibut to be brought on board for you. Some vessels will station a second crewman near the roller during your sample collection to net or gaff the halibut aboard after it falls from the hook.

One of your duties is to assess the way halibut are handled on your vessel. Document the following in your logbook:

- The methods that each roller man uses to release halibut and the effectiveness of this method in minimizing injuries to halibut.
- Anytime that a halibut hits the crucifer. Document the roller man’s name, the time and date, and any circumstances surrounding the incident. Inform the captain any time you witness halibut hitting the crucifer.
- Whether or not the captain and crew are cooperative with your sampling efforts.

If the roller men are not utilizing careful release methods, document this thoroughly in your logbook and tell the captain what you are seeing. Document all conversations with the captain on the subject and note if the captain is aware that the halibut are being released improperly. Document whether there is a general disregard of careful release methods or if it is just a particularly careless or inexperienced roller man. Bring all of these issues to the attention of the Observer Program staff as soon as possible.

SEABIRDS

Longline vessels attract significant numbers of seabirds which feed on the fish discards. Seabirds near the vessel may become hooked by the gear during gear retrieval. Seabirds may attempt to feed on the baited hooks as the gear is being set. They are often hooked or snagged and dragged down with the gear and drowned. Regardless of when a seabird is hooked, all are considered “caught” and must be included in the species composition sample.

ESTIMATING PERCENT RETAINED

Each species reported in the species composition samples for a set must have an associated estimation of percent retained. Obtaining this information will vary

depending on what your vessel is catching and retaining on a daily or haul-to-haul basis.

Work closely with the vessel to determine what species they will be retaining. An individual fish is considered fully retained (100% retained) when more than 15% of its round weight is turned into product. For these species, you must keep a separate tally of all retained species that drop-off or are discarded at the rail (e.g., sandflea eaten fish). The separate count for drop-offs and retained species discarded at the rail is used to determine the percent retained.

If you notice retained species being discarded in the factory, do not include them in the percent retained estimation. They are accounted for in the estimate of discards; see “Estimating Discards” on page 7-8.

For species not retained for consumption or product, you do not need a separate tally for drop-offs and discards because the percent retained for these species is zero.



For CP longline vessels targeting Pacific Cod in the BSAI, it is extremely important to keep a separate tally of drop-offs and retained species discarded at the rail. These numbers will be used in conjunction with the Pacific Cod flow scale weight to determine the total catch of Pacific Cod for the haul.

Calculate percent retained after the set is completed. Use the total tally number for the species and the total drop-off number of that species lost or discarded at the rail during all tally sample periods within a haul. Refer to all the samples collected from the set for this information. The percent retained you report for a species must be consistent for that species over all the samples collected during the set. For this reason, calculate percent retained after the set is completed.

| | | | | | | | | |
|--|---|---|---|---|---|-----|---|--|
| Total number of a species tallied from all samples | - | Total number of drop-offs and discards at the rail from all samples | = | Total number of a species caught from all samples | X | 100 | = | Total percent retained of that species |
|--|---|---|---|---|---|-----|---|--|

Every species reported in a sample must have a percent retained record. For examples of recording percent retained, see the species composition data examples at the end of this chapter.

If the vessel retains a species during the tally that is part of a species complex (e.g. *Bathyrāja*, Shortraker/ Rougheye

Rockfish), a visual estimate should be used to report the percent retained due to the variability on how vessels handle these species coming up on hooks and in the factory. You must visually estimate the percent retained for all individuals in hand and identified to species. You will also visually estimate the percent retained for the species complex tallied during the tally period. For example, on a CP longline vessel targeting Pacific Cod the observer tallied on average about 53 *Bathyrāja* per sample. For the bycatch collection the majority of the skates encountered were identified as Alaska Skates with a few Bering Skates. The crew kept most of the Alaska Skates so the observer visually estimated the percent retained to be 70%. For Bering Skates, they were all small and no small skates were ever retained. Therefore, the Bering Skate percent retained is 0%. For *Bathyrāja* unidentified, the observer visually estimated the percent retained at 55% keeping these things in mind:

1. The percent retained for all *Bathyrāja* species in hand.
2. The proportion of large vs. small skates coming up on the line.

Clearly document in your logbook the method you used to determine percent retained. If you have any questions, contact Observer Program field staff or your inseason advisor.

SPECIMEN COLLECTION ON LONGLINERS

Your duties for collecting measurements and other biological data on longline assignments are the same as for all other vessels. On longliners, these may be hindered by lack of space or lack of cooperation from crews. Lack of space can be a problem on smaller catcher vessels. *It is preferred that you collect fish for your predominant species length and specimen data during your subsample.* You may be able to collect the required amount of species measurement and specimen data by collecting a small random number of fish from each sample, rather than all from just one randomly chosen sample. The Deck Form examples at the end of this chapter show data collected in this way. If space and time are not an issue, you can randomly choose one sample from which to take measurement and specimen data. For more information on length and specimen data, refer to “FISH MEASUREMENT AND SPECIMEN COLLECTION” beginning on page 13-1. **Remember,**

lengths and specimens collected during your longline subsample should be given sample design code 9 - "Other Random."

If you are unable to collect measurements or specimens because of space constraints, contact NMFS as soon as possible. In your logbook, document any difficulties encountered and the methods you used.

Specimen Data and Uncooperative Crews

In the past, some longline crews have refused to allow observers to cut the fish as needed to obtain sexed length frequency data. In your logbook, document any interference to your collection of sexed length frequency measurements and contact Observer Program staff as soon as possible.

If you encounter difficulties, seek the cooperation of the captain in completing your duties. Vessel crew are required to allow you to determine the sex of fish and we are seeking their cooperation. Be mindful that the crew may only protest to your cutting of fish if the cut damages their final product. If this is the case, ask them which cuts would not damage the product. Many observers have successfully used a pectoral cut to determine the sex of roundfish, without destroying product. If the cut you need to use is time consuming or difficult, request crew assistance. Most fishermen are cooperative when they realize the extra time you are taking is to prevent damage to their product.

If the crew continues to be uncooperative, ask the captain if it would be acceptable to cut only a subsample of your measured fish. Request that you be allowed to cut 10 or 15 fish from your approximately 20 measured fish. If you do sex fewer fish than you measure, the sexed subset must be randomly selected. Unsexed data is more valuable than no length data, so if the captain is adamant that no fish are cut, you should collect unsexed length frequency samples. Fully document in your logbook all interactions with the crew and all methods you used to collect lengths. Please see "Regulatory Support for Cutting Fish to Obtain Sex Data" on page 13-11 for more information.

CATCHER PROCESSOR (CP) MONITORING OPTIONS

Longline CPs that are members of the Freezer Longline Conservation Cooperative (FLCC) have two monitoring

options when they are endorsed to catch and process Pacific Cod in the BSAI.

- Option 1: Carry one observer at all times, have a certified sample station, and a flow scale with a video monitoring system (for information on testing flow scales, see page 2-31). The majority of the CP fleet will use this option. The video monitoring system is used to ensure all Pacific Cod brought on board are weighed on the flow scale. It must be noted that all Pacific Cod caught, *regardless of target fishery or area fished*, must go over the flowscale. Some vessels using Option 1 voluntarily carry an additional observer.
- Option 2: Carry two observers at all times and have a certified sample station. Vessels using Option 2 are not required to have a flow scale.



Flow scales are used differently on trawlers and longliners. On trawlers, the entire catch must be weighed on the flow scale. On longliners, only Pacific Cod is weighed on the flowscale.

The selected monitoring option is required to be used when the vessel is operating in the BSAI or GOA groundfish fisheries when directed fishing for Pacific Cod is open in the BSAI, or while the vessel is fishing for groundfish under the Western Alaska Community Development Quota (CDQ) Program. The observer duties outlined below depend on which monitoring option your vessel chooses. Contact your inseason advisor if you have any questions.

Vessels with One Observer:

1. Sample according to the RST or RBT. On Catcher Processors, the expectation is that you will follow the schedule dictated by the RST or RBT. Doing so will result in approximately 60% of all hauls (100% of "on" hauls) being sampled for species composition.
2. Witness the daily flow scale test. *This requires working closely with the vessel to ensure this is done when you are awake.* Contact your inseason advisor if you are having problems scheduling the daily flow scale test. See "Flow Scale Testing" on page 2-31.
3. Document any problems with the flow scale or video monitoring system in your daily notes and be sure to include approximate times. The observer is *not responsible* for testing or making sure the flow scale or video monitoring system is working. This is strictly

between the vessel and NMFS Regional Office. Your job is to simply document if the systems are not functioning (e.g., the video screen is blank or the flow scale is continuously faulting).

Vessels with Two Observers:

All hauls must be sampled. If a haul is not sampled, document the circumstances in your logbook and contact your inseason advisor.

INDIVIDUAL FISHING QUOTA (IFQ)

In 1993, the North Pacific Fisheries Management Council and the Secretary of Commerce approved the Individual Fishing Quota (IFQ) program for the halibut and Sablefish fisheries. This policy changed these fisheries from an open access fishery with a very short season to a limited entry fishery managed through an individual quota assigned to each fisherman. The individual quotas are allocated to fishermen that have historically been involved with either the sablefish or halibut fisheries. The individual shares of the quota can be sold or transferred to different individuals and companies. The IFQ system allows fishermen to fish for their individual quota throughout the fishing season.

Vessels and Gear

Typically, the vessels that fish Sablefish and halibut IFQ are smaller vessels, although some larger CPs also participate in this fishery. When targeting Sablefish, the vessels typically set gear much deeper and retrieve the gear at a slower pace compared to Pacific Cod or Greenland Turbot fisheries. When targeting halibut, the vessels set their gear in areas that are shallower, but halibut gear tends to have fewer hooks spread farther apart, so the rate of hook retrieval will be equivalent or even slower than Sablefish retrievals.

Composition Sampling

Sets targeting halibut must be sampled for species composition. The methods of choosing which sets to sample and which sampling methods to use are the same as those discussed earlier in this chapter. Follow normal sampling procedures for tally and weighing periods to collect your composition samples. IFQ vessels tend to be less automated and gear retrieval is slower. On some IFQ vessels, observers have been able to weigh all non-predominant species from the tally period. Obtain

average hook counts in the same manner as in the non-IFQ fisheries. Because the gear is maintained by hand and may not be repaired as diligently, you may need to verify hook counts more often. *Remember, you must verify hook counts on at least 1/5 of a set of gear twice per week.*

Halibut IFQ Vessels Fishing in State Waters

Halibut IFQ vessels fishing in State waters are prohibited from retaining bycatch while harvesting halibut IFQ. This is a particularly sensitive issue when the bycatch is Sablefish. To ensure that you are able to continue collecting quality data without interfering with State waters requirements and prohibitions, please follow these guidelines:

1. Ask the vessel captain to inform you when they are harvesting halibut in State waters. If the vessel is harvesting halibut in State waters, you must ensure all bycatch is returned to the sea as soon as possible with minimal injury.
2. When setting up your sampling design, consider shorter tally periods so that the bycatch saved for you can be worked up and returned to the water as soon as possible.
3. If the bycatch includes Sablefish, do not have the crew save Sablefish during the tally period so that they are not lingering on deck. Collect Sablefish as a subsample (before or after the tally period), weigh each fish as it comes off the line, and return them to the sea as quickly as possible with minimal injury.
4. If your Halibut IFQ vessel is fishing in State waters and Sablefish is the predominant species, do not collect sexed lengths or otoliths from Sablefish. Instead, choose the next most predominant species as specified in the Length and Specimen Priority List.

Bycatch Retention

When fishing IFQ, boats must abide by retention regulations for rockfish, pollock and Pacific Cod. Retention status will change for some species throughout the year and it is the vessel operators responsibility to track these changes. Retention information will be captured by reporting your percent retained in species composition. Contact the Observer Program if you have questions regarding retention during your cruise.

When Halibut is the Predominant Species

Your sampling will change slightly when halibut is the predominant species. The following are the sampling protocols that change:

Halibut Weight Collection

Because of their size, halibut present a problem for observers when they are the predominant species on an IFQ vessel. When observing on halibut IFQ vessels, you will need to account for halibut on the line.

There are two accepted methods to record halibut during IFQ fishing. Method 1 is preferred. Use method 2 only if method 1 is not possible. The methods described below may not be combined:

1. You may record halibut by estimating and recording the length of each halibut to the nearest 10 centimeters. Use the "Halibut Worksheet" in ATLAS and apply the derived weight to the associated species composition sample.
 - If you are unable to assess the length of halibut for reasons such as the fish being obscured from view, or not whole due to depredation, do not abandon your sample. Rather, tally the halibut separately from those that you were able to estimate their lengths. Enter the halibut as a separate line in your final data without an associated weight. Document the problem in your daily notes and inform Observer Program staff at the earliest opportunity. Limited visibility is more likely to occur on small vessels using snap gear, but may be encountered on some larger catcher vessels.
2. You may record halibut by tallying all halibut in your tally sample and collecting and recording a weight sample of at least 20 randomly collected halibut per set. To randomly collect 20 halibut weights per set, use a random starting point and either collect the next "X" number of halibut or every "Nth" halibut. For those halibut far too large to weigh, you may measure the halibut and use the "Halibut Worksheet" in ATLAS to derive the weight. *When collecting 20 fish for an average weight you must have the fish in hand (do not use estimated lengths).*

If you begin with method 1 and decide to abandon it for method 2, use the weight data collected for method 2 only.

If you are unable to see every halibut during your tally period because the line is obscured, you cannot rely on estimating lengths to determine the weight of halibut in your sample.

- In these situations collect halibut weight data during your tally period following the guidance described above. Alternatively see "When Halibut is the Predominant Species" under "Subsamples for Predominant Species" on page 8-17
- If you are unable to estimate the length of every halibut in a single sample but are able to in the others, an average weight must be collected and this is the only method that can be used for that haul.
- All estimated and actual halibut length and weight data must be collected and/or verified independently by the observer.
- Do not use length data collected by the vessel to determine the weight of a fish for inclusion in your composition data.

Halibut Injury Assessments

For information regarding halibut injury assessments on IFQ vessels, see page 12-9 in the Prohibited Species chapter.

CDQ SPECIFIC INFORMATION FOR FIXED GEAR CATCHER VESSELS

Delivery weights are used to manage the CDQ quota for fixed gear catcher vessels. It is the plant observer's responsibility to verify delivery information. Non-trawl catcher vessels that participate in the CDQ fishery may fish 24 hours/day and have unsampled sets. In most cases you will be able to sample all sets given this vessel type's fishing style. These vessels are not required to have an observer sampling station or a motion compensated platform scale.

CDQ SPECIFIC INFORMATION FOR FIXED GEAR CATCHER/PROCESSORS

Longline and pot CPs that participate in CDQ fisheries have up to two hours to designate a set as CDQ in their logbook after completion of weighing all catch in the haul. As long as the vessel treats a set as CDQ they may designate it as such or change their mind and designate

it as open access or IFQ. The vessel must record a CDQ group number in their logbook for all CDQ sets to identify which group they are fishing for. Check the vessel's logbook information carefully when filling out your VHF, since a vessel may be fishing for several CDQ groups or participating in multiple fisheries.

Each CDQ set must be sampled for species composition if there are 2 observers on board. If the vessel carries one observer during a CDQ fishery, you should continue your sampling schedule used during open access fishing. If a set is not sampled due to weather or illness document in your logbook why you were unable to sample the set. If your vessel has 2 observers and a CDQ set was not sampled, document the reason why it was not sampled and notify your inseason advisor.

CPs participating in Limited Access Privilege Programs (LAPP) are required by regulation to have an observer sampling station. Refer to page 2-32 for more information on sample station requirements. It is your responsibility to test the platform scale daily (see "Platform Scale Testing" on page 2-30). Do not refuse to sample or tell the vessel they can't fish if the platform scale is not functioning or if one is not available to you. Inform your inseason advisor of the situation and use your NMFS issued scales. *All non-trawl CPs have the ATLAS program so direct any questions regarding sampling or CDQ requirements to your inseason advisor.* Send in your data daily while fishing CDQ.

DECK FORM INSTRUCTIONS

The waterproof raw data forms provided by the Observer Program are meant to be taken out on deck. On ATLAS vessels these replace the paper Species Composition Form. *Never recopy raw data and always return to your debriefing interview with your original data.* The Deck Forms are an important component of your data documentation. It is important to fill out the forms completely and legibly!

Enter data from the Deck Form directly into the ATLAS system.

The Deck Form is double sided with two sample blocks available on each side. The header information at the top of the Deck Form must be filled out and pertains to both sample blocks below it. *You cannot have two samples from different hauls on a single side of the Deck Form.* You must maintain a separate set of forms for each vessel to which you are deployed.

Multiple samples and subsamples taken within a set should be maintained completely independent of each other with their own unique sample number and sample block(or blocks). If you have to combine samples later, check the circle next to "Combined?" for the affected samples (for information on combined samples see "Combined Samples" on page 8-19).

Remember that sample data represent tally individuals and weight individuals from within the tally period, and subsample data represents weight individuals from outside the tally period. Subsamples have a specific numbering system associated with them, explained in "Subsample number" below.



Maintain a separate set of forms for each vessel.

Examples showing completed Deck Forms start on page 8-32. Raw data recorded on the Deck Form should be organized in a manner similar to these examples. If there are two or more observers on a vessel, each observer must record their initials on the Deck Form next to each sample they collect. *The following Deck Form rules must be followed for all longline vessels. All fields must be filled out completely:*

Date: Enter the date that the last hook of the set was retrieved. For the month and the day, use leading zeros when needed (e.g., 01/01/17 for January 01, 2017). This date must match the date on all other forms.

Cruise, Permit: Your cruise number will be given to you during training or briefing, or by your employer. Vessel permits are listed on page A-31.

Haul No., Offload No: For each sample taken within a set, enter the set number the sample came from. Sets can be numbered sequentially beginning with the number one, or you can follow the captain's numbering convention *if the captain is not repeating set numbers with each new trip.* On longliners, it is generally better if you can follow the captain's numbering system; when sets are retrieved out of order it can be difficult to track sets if your numbering system is different.

Set numbers must be unique for the vessel. If you disembark the vessel and then embark again at a later date, you can 1) continue numbering the sets from the number you left off with, 2) continue with the captain's numbering convention (if s/he is not repeating set numbers), or 3) skip a few numbers (e.g., if you numbered

sets of the first trip 1, 2, 3 and 4, you could number sets of the next trip as 11, 12, 13, 14). Longline observers do not collect composition data during an offload; leave the offload field blank.



Set numbers do not have to be sequential (although it is easier if they are), but they do have to be unique for the vessel.

Page_ of_ for Vessel/Plant: For each vessel assignment Deck Form pages are numbered consecutively starting with 1. All forms with raw data must be included in the total pages for the vessel/plant.

Page_ of_ for Haul/Offload: All Deck Forms associated with each individual haul/offload are numbered consecutively starting with 1 of “n” for the haul and its associated data. For an example see Figure 8-9 on page 8-35.

Sample number: Every sample taken from within a set must have a unique identifying sample number. Number samples taken within a set sequentially, starting with the number 1. You do not need to make sample numbers *between sets* unique; you can start with the number 1 for the first sample of every sampled set.

Subsample number: For longliner sample data, the only time you will have a *subsample* block of data is when you are reporting weight data from fish taken outside the tally sample period. Subsamples must be linked to the parent samples from which they came. You do this by using a numbering convention designed specifically for subsamples: every subsample number must be three digits in length, with the first digit designating the parent sample from which the subsample came, and the next two digits indicating the number of that subsample for the parent sample. Subsample numbering convention is explained further below:

- The first subsample of sample number 1 for a set should be numbered 101, the second subsample for sample number 1 of a set should be numbered 102, the third 103, and soon...
- The first subsample of sample number 2 for a set should be numbered 201, the second subsample for sample number 2 of a set should be numbered 202, the third 203, and soon...
- The first subsample of sample number 3 for a set should be numbered 301, the second subsample for sample

number 3 of a set should be numbered 302, the third 303, and so on.

Sample size: *Every sample must have a sample size indicating the number of segments tallied on longliners.* Record the total segments in your sample rounded to two decimal places, and circle the “segments” text. If you are on a snap gear vessel always record a “.01” in this field. *Subsamples do not have a sample size on longliners.* Leave the sample size blank for subsample data.

of Sampled Hooks: If your vessel is fishing two different size segments of gear within a sample, calculate the total number of hooks and enter it here as a whole number. Otherwise, leave this field blank for fixed hook gear. See Figure 8-10 on page 8-37. On a snap gear vessel enter the total number of hooks in the sample.

Pre-sorted: Do not check this field. You cannot have pre-sorted samples on longliners.

Combined samples: If the samples for a set are going to be combined in the reported data, check the circle next to the word “Combined” for *only those samples that will be combined.* When these data are entered into ATLAS, samples designated as combined are rolled up into a single sample entry. See “Combined Samples” on page 8-19 for a description of when samples must be reported as a “Combined Sample.”

Unable to Follow Design: No longer in use. If you have an older form do not make an entry in this field. When entering data into ATLAS, this field is labeled “Sampled As Designed.” Do not enter this field in ATLAS. It will default to “N” and should be left alone.

No Fish in Sample: For longline vessels, if there are no fish in your tally period, mark this field on the top of your Deck Form. In ATLAS, enter an “N” for No Fish in Sample.

Species: For species (other than halibut) or species groups that you tallied and weighed, there will be one entry for total tally number of that species or species group *minus* any fish of that species or group that you weighed. There will be another entry for the number and weight of the individuals of that species or group that came from within the tally sample and were weighed. Fish tallied to species are listed by their common name. Fish tallied by group are listed by their group name. Fish in hand are listed by their species name or group name

as appropriate. Fish from subsamples are listed by their common or group name as appropriate.

If you were not able to weigh representatives of species or species group tallied, there will only be one entry for the species or group: the total number tallied.

For halibut, you will typically have a length estimate for all tallied individuals. You need only one line entry in these instances; the total number tallied and total weight for these individuals. The weight is derived from the halibut length/weight table. If you used the less preferred option of obtaining halibut weight information, you will need two entries: one for tallied individuals minus any weighed or actually measured, and one for the weighed or measured fish.

Sex: Tanner crab, king crab, and salmon should be listed separately by species and sex. Record an “M” or “F” for these species when sex is determined. *Leave the sex field blank for any unsexed prohibits and for non prohibited species.* Do not record sex codes for any other species even if they were sexed for length samples.

Number: For each weighed species, enter the number of individuals weighed. For tally period data, record the number of individuals tallied minus any weighed from that species or species group. *Every species entry must have a number record!*

Use as many lines and columns as necessary for each species.

- For fish waste (code 899) and miscellaneous items (code 900) enter the actual number of items.
- For subsample data, enter the number of individuals weighed. Unlike samples, subsamples must always have a number *and* a weight.

Weight: For weighed fish, enter the weight by species with a well defined decimal. Weights must be recorded to the nearest 0.1 or 0.01 kg. Do not enter weights to more than two decimal places. If a species in your sample was too small to register a weight on the scale (e.g., one brittle star) enter the weight as 0.01 kg. This holds true for both sample and subsample data. For halibut tallied by estimated length, use the “Halibut Worksheet” in ATLAS to derive weight (see Figure 18-26 on page 18-13). You may use the length/weight tables provided in briefing/training to determine the weight of longnose and Big Skates that exceed the capacity of your scales. To use

these tables you must have an actual length. Estimates of lengths are not acceptable.

For fish from the tally period that were not weighed, enter a zero in the weight field by species. Remember to subtract the number of any weighed individuals from that species or species group.

Percent Retained: Record the percent retained for all species in your species composition samples rounded to the nearest whole percent. See “Method for Tallying Drop-Offs and Discarded Species at the Rail of Retained Species” on page 8-10 for instructions on how to record this information on your deck sheet. Record percent retained calculations on your Deck Form. An example of percent retained calculations is illustrated see Figure 8-8 on page 8-34.

Length, viability, injury, specimen, tally data, notes: Use the blank area of the Deck Form sample block to record tally data. Use this space to record other sample specific information: sex/length information, specimen information, halibut assessments, notes pertaining to any biases to the sample, etc. Make comments about anything unusual with the catch or your sampling technique for the set. More complete descriptions of these notes should be documented in your logbook. Making note of unusual occurrences on your species composition form will assist in the debriefing process, and help you distinguish one set from the others. *Raw data of this sort must be documented!*

Tally K/P: This box on the lower right of the right side of the Deck Form indicates where to record your tally keypunch. A tally keypunch is the sum of all tally marks. When compared to the species number keypunch, the “Tally K/P” will indicate any missing organisms in the species composition data. When summed for all species, this number should match the keypunch check entry after your species and weights have been recorded on the left hand side of the Deck Form. *This is a required field on the Deck Form.*

Keypunch Check: In the spaces to the right of the words “Keypunch check,” write the calculated sum for species number, and species weight that you recorded for the sample. If your species composition sample has too many species to fit in one sample block, enter the total sums on the keypunch line in the first block for the sample and leave the keypunch line blank for the second block used for the sample.

Keypunches are a valuable tool for staff who edit your data. If the keypunch value the computer calculates does not match the keypunch value you wrote down, staff know to double check for errors in the entries. If you are sloppy with your keypunch calculations, staff have to investigate each discrepancy. This is a waste of valuable time for both you and for staff. Please double check your keypunch summaries!

SNAP GEAR SPECIES COMPOSITION SAMPLING

Collection of composition data (tally and weight data) from longline vessels that use snap gear requires some modifications to standard sampling protocols. In the absence of individual segments, your sample size will be determined by the total number of hooks in the set, the sample fraction, and the number of samples you plan to collect. The determination of sample size will become a deciding factor when developing a sampling plan.

On snap gear vessels, you will use a spatial frame and will need to count hooks during the tally period to determine sample size. *Without a hook count during your composition sample there is no way to determine the sample size.* On snap gear vessels using segmented gear you may be able to use a spatial design based on randomly selected segments. A hook count to determine sample size must still be completed as hooks per segment will still vary.

Note: If you are only able to determine total haul size by counting total hooks during retrieval, a census may be the best method for obtaining species composition data.

Snap Gear Sample Design

To utilize a systematic spatial design on a snap gear vessel, use the following steps:

1. Determine the total number of hooks in the set.
 - This will be based on the actual number of hooks counted when the gear was deployed.
 - May be based on an estimate of hooks in the set (if you were not able to count hooks when gear was set).
2. Determine what portion of the haul you wish to sample (referred to as the sampling fraction).
3. Divide the total hooks set by the sampling fraction.

4. To determine sample size, divide the number of hooks determined to be your sampling fraction (step #3) by the number of samples you wish to collect.
5. Now that you have determined your sample size, divide the # of hooks in the haul by the # of hooks per sample and this will establish how many total units are in the frame.
6. Randomly pick a start point with in your established interval and begin sampling. The interval is determined by your sampling fraction used in step #3.

If the vessel is setting segmented snap gear then you can randomly select segments to tally (similar to selecting segments on a fixed hook vessel, see “Addressing Challenging Sampling Situations” on page 8-9. *Remember to count total hooks in the segment during your composition sample as hooks per segment will vary.*

Practical Application of a Spatial Design on a Snap-Gear Vessel

When sampling snap-gear, it is not practical to count the hooks between/during the set to determine where your spatial samples begin. In order to collect samples you will have to use time as a proxy to guide you to your spatial unit. An estimate of time equal to your sample unit needs to be established. You can come up with this estimate using one of the following methods:

- You can use an estimate of the haul back time divided by the number of sample units to establish a relative hauling time per unit.
- You can use an estimate of retrieval time of hooks in your sample and use that to establish time intervals between sample units.

Initially the captain and crew can help you with this estimate, but as you gain experience on the vessel you will be able to make this estimate on your own. Once you are familiar with the hauling speed of the vessel you can come up with your own estimate of time to retrieve the haul or sample unit and work from there. Use this time as a guide to work through your spatial units. Apply the time estimate to your spatial design to find your start time for the spatial unit and the intervals between sample start times.

Because time is used to approximately determine where your sample should be taken, you may at anytime adjust time per spatial unit as the retrieval speeds changes.

Time is used to help you track the progress of retrieval and as an indicator as to when to get ready to begin tallying (or conduct other tasks). However, how you determine the end of the tally period will be when the number of hooks in your spatial unit have been tallied.

It is recognized that time and space constraints on small vessels will affect the amount of work that can be completed during a single haul. As a result you may have to reduce sampling effort to obtain other data such as average weight collections of the predominate species and bycatch, and other biological data. If you are unable to accomplish all of your duties reliably review the priority lists in Essential Information (see “Data Collection Priorities” on page 2-2). Contact NMFS staff for assistance if needed. It is important to document your sampling decisions in your daily notes.

Determining Number of Hooks Sampled (Snap Gear)

In the absence of individual segments you will need to begin your tally at a chosen time. When your sample begins you must count hooks along with all organisms on the line throughout the tally period. When you reach the predetermined number of hooks in the sample unit the tally period ends.

In order to determine the size of your composition sample on a snap gear vessel you must count hooks as gear is retrieved during your composition sample. Two ways to keep track of the number of hooks retrieved are:

1. Tally all hooks that come aboard during your sample period. Your tally will include both empty hooks and the organisms caught by the vessel.
2. Keep a separate tally for empty hooks. Then combine the number of empty hooks with the number of organisms tallied for a total number of hooks sampled.

If you census the entire set for your sample and you determined the total number of hook during deployment, you do not have to count hooks during the retrieval.

You must document the number of sampled hooks on your Deck Form for each sample. Record this number in the “# of Hook Sampled” field on the Deck Form with “.01” segments recorded in the “Sample Size” field. See

“Example of Deck Form for Halibut Longliner Snap gear Sample and Halibut Injury Assessments” on page 8-38.

Example: A vessel sets 1404 hooks. You decide to sample 1/3 of the haul equaling 468 hooks. You wish to take 3 samples and so divide 468 hooks by 3, equaling a sample unit size of 156 hooks. Total hooks of 1404 divided by the 156 hook sample size equals 9 units. The captain estimates it will take 2 hours (120 minutes) to retrieve the haul. 120 minutes divided by 9 units equals 13.33 minutes (13 minutes and 20 seconds) per unit. When the chosen time unit arrives you begin tallying at the next hook. Tally all organisms on the line as well as empty hooks. Once the sum of the empty hooks and all organism reaches 156 the tally period ends, and other tasks can be completed. Your next sample will be collected 2 units later, or 26.67 minutes (26 minutes and 40 seconds) after the sample ends.

Recording Snap Gear Sample Size

Sample size on a snap gear vessel will always be recorded as the total hooks actually tallied during your sample unit. Record the total number of hooks sampled in the “# of Hook Sampled” field on the Deck Form with “.01” segments recorded in the “Sample Size” field. If empty hooks are tallied and then added to the total number of tallied organisms this raw data must be documented on the Deck Form.

Snap gear Composition Samples

Snap gear composition samples are collected in the same manner as on vessels fishing fixed hooks. All hooks during the sample period must be counted to determine sample size. Due to the deck shelter design of some snap gear vessels, observers may have limited visibility of the line coming out of the water preventing your from seeing drop-offs.

Keeping your safety in mind, make all attempts to establish a safe area with good visibility of the line. During the course of sampling a set, there will be times you can see the line exiting the water and times you cannot. Follow these guidelines when visibility is limited:

- When you can see the line exiting the water, tally according to guidelines described in “Tally Composition Samples” on page 8-9.
- If you cannot see the line coming out of the water you can tally fish as they come into view over the side. Work with the crew to identify drop-offs. If there is a drop-

off and the crew tells you what species it was, tally it to species but separately than those you saw yourself and note that it was identified for you by the crew. If the crew are unsure of the species and simply inform you of a drop-off, tally this fish as “fish unidentified” and note that it was identified by the crew (see “Tally Visibility Challenges” on page 8-15).

- For all hauls where you can't see the line exiting the water record and estimate of the time you had good visibility of the line coming out of the water and record this on the Deck Form and in your daily notes.

Snap Gear Average Weights- Hook and Snap Removal

Remove the snap hook gangion set-up from the fish before collecting weights (snap gear). Weighing the fish with the snap gear (hook and snap) in the mouth will add weight to the fish. Document if you cannot safely remove the snap gear set. If only the hook and a piece of gangion are in the fish mouth you do not need to remove it as the weight added is minimal.

Snap Gear Deck Form Instructions

Follow all Deck Form protocols except for the following:

Sample Size: Enter “.01” segments in this field.

of Hooks Sampled: Enter the actual number of hooks in your composition sample.

LONGLINE DECK FORM EXAMPLES

The following deck form examples illustrate how to properly record longline sampling data.

| DECK FORM | | | | | Page <u>2</u> of _____ for Vessel/Plant | | | | | | | | | | | | | | | | | | |
|---------------------------------|-------------------------------------|--------------------------------|----------|---|---|-------|-------|-------|-----|------|-------|-------|-------|-------|-----|--|--|--|--|--|--|--|--|
| Date | Cruise | Permit | Haul No. | Offload No. | Page <u>1</u> of _____ for Haul/Offload | | | | | | | | | | | | | | | | | | |
| 4/06/23 | 28500 | 6636 | 102 | | | | | | | | | | | | | | | | | | | | |
| Sample #: <u>1</u> | | Sub-Sample #: | | Sample Size: <u>2.00</u> | <input checked="" type="radio"/> Kgs Segments pots # of Sampled Hooks: | | | | | | | | | | | | | | | | | | |
| Presorted <input type="radio"/> | | Combined <input type="radio"/> | | No Fish in Sample <input type="radio"/> | | | | | | | | | | | | | | | | | | | |
| Species | Sex | # | Weight | % ret. | Length, viability, injury, specimen, tally data, measurements, bird observations, sample design, notes: | | | | | | | | | | | | | | | | | | |
| ----- KEYPUNCH ----- | <input checked="" type="checkbox"/> | | | <input checked="" type="checkbox"/> | <p>18seg x 1/3 = 6seg ÷ 3samples = 2seg/unit 18seg ÷ 2seg/unit = 9units RN=1 S/L RN=1</p> <p> <table style="display: inline-table; border-collapse: collapse;"> <tr> <td style="border: 1px solid black; padding: 2px;">1-2</td> <td style="border: 1px solid black; padding: 2px;">3-4</td> <td style="border: 1px solid black; padding: 2px;">5-6</td> <td style="border: 1px solid black; padding: 2px;">7-8</td> <td style="border: 1px solid black; padding: 2px;">9-10</td> <td style="border: 1px solid black; padding: 2px;">11-12</td> <td style="border: 1px solid black; padding: 2px;">13-14</td> <td style="border: 1px solid black; padding: 2px;">15-16</td> <td style="border: 1px solid black; padding: 2px;">17-18</td> </tr> <tr> <td style="border: none;">S/L</td> <td style="border: none;"></td> <td style="border: none;"></td> <td style="border: none;"></td> <td style="border: none;"></td> <td style="border: none;"></td> <td style="border: none;"></td> <td style="border: none;"></td> <td style="border: none;"></td> </tr> </table> </p> <p>Halibut Injury - Seg 4</p> <p>PCod - (163) D/O L=3 Pollock - (34) D/O L=2</p> <p>Bathyraja - <input checked="" type="checkbox"/><input checked="" type="checkbox"/><input checked="" type="checkbox"/><input checked="" type="checkbox"/> U (23) Kam/Arrow - <input checked="" type="checkbox"/><input checked="" type="checkbox"/><input checked="" type="checkbox"/> (19) Flathead Sole - <input checked="" type="checkbox"/><input checked="" type="checkbox"/><input checked="" type="checkbox"/> L (17) Rock Sole - <input checked="" type="checkbox"/><input checked="" type="checkbox"/><input checked="" type="checkbox"/> L (17) I. Lord - L (2) Sea Whip - U (3) Sculpin - <input checked="" type="checkbox"/> U (8)</p> <p style="text-align: right;">Tally K/P 295</p> | 1-2 | 3-4 | 5-6 | 7-8 | 9-10 | 11-12 | 13-14 | 15-16 | 17-18 | S/L | | | | | | | | |
| 1-2 | 3-4 | 5-6 | 7-8 | 9-10 | 11-12 | 13-14 | 15-16 | 17-18 | | | | | | | | | | | | | | | |
| S/L | | | | | | | | | | | | | | | | | | | | | | | |
| Sample #: | | Sub-Sample #: | | Sample Size: | <input type="radio"/> Kgs Segments pots # of Sampled Hooks: | | | | | | | | | | | | | | | | | | |
| Presorted <input type="radio"/> | | Combined <input type="radio"/> | | No Fish in Sample <input type="radio"/> | | | | | | | | | | | | | | | | | | | |
| Species | Sex | # | Weight | % ret. | Length, viability, injury, specimen, tally data, measurements, bird observations, sample design, notes: | | | | | | | | | | | | | | | | | | |
| ----- KEYPUNCH ----- | <input checked="" type="checkbox"/> | | | <input checked="" type="checkbox"/> | <p><u>Halibut</u></p> <p>50 - L - 3 60 - L - 1 70 - 80 - <input checked="" type="checkbox"/> - 5 90 -</p> <hr style="width: 50%; margin-left: 0;"/> <p>(9)</p> | | | | | | | | | | | | | | | | | | |

Method for Tallying Halibut- The estimated lengths, frequency of each estimated length and total number must be documented on the Deck Form. Halibut totals for number and weight will be calculated using the Halibut Worksheet in ATLAS and recorded on the Deck Form (see Figure 8-8).

Figure 8-6: Example of Raw Tally Data From a Longline Vessel (Part 1)

DECK FORM

| | | | | | |
|---------|--------|--------|----------|-------------|---|
| Date | Cruise | Permit | Haul No. | Offload No. | Page <u>2</u> of _____ for Vessel/Plant |
| 4/06/23 | 28500 | 6636 | 102 | | Page <u>1</u> of _____ for Haul/Offload |

| | | | | |
|---------------------------------|--------------------------------|--------------------------|------------------------|---|
| Sample #: <u>1</u> | Sub-Sample #: | Sample Size: <u>2.00</u> | Kgs Sogmona pots | # of Sampled Hooks: |
| Presorted <input type="radio"/> | Combined <input type="radio"/> | | | No Fish in Sample <input type="radio"/> |

| Species | Sex | # | Weight | % ret. | Length, viability, injury, specimen, tally data, measurements, bird observations, sample design, notes: | | | | | | | | | | | | |
|----------------------|------|------|--------|--------|--|-----|-----|----|------|-------|-------|----|------|------|-------|----|-------|
| ----- KEYPUNCH ----- | | 295 | 101.85 | X | | | | | | | | | | | | | |
| P. Cod | | 163 | 0 | 94 | 18 seg x 1/3 = 6 seg ÷ 3 samples = 2 seg/unit 18 seg ÷ 2 seg/unit = 9 units R/N = 1 S/L R/N = 1 | | | | | | | | | | | | |
| Pollock | | 5 | 8.00 | 92 | | | | | | | | | | | | | |
| Pollock | | 29 | 0 | 92 | <table border="1" style="font-size: small; border-collapse: collapse;"> <tr> <td>1-2</td> <td>5-6</td> <td>52</td> <td>9-10</td> <td>13-14</td> <td>17-18</td> </tr> <tr> <td>51</td> <td>13-4</td> <td>17-8</td> <td>11-12</td> <td>53</td> <td>15-16</td> </tr> </table> | 1-2 | 5-6 | 52 | 9-10 | 13-14 | 17-18 | 51 | 13-4 | 17-8 | 11-12 | 53 | 15-16 |
| 1-2 | 5-6 | 52 | 9-10 | 13-14 | 17-18 | | | | | | | | | | | | |
| 51 | 13-4 | 17-8 | 11-12 | 53 | 15-16 | | | | | | | | | | | | |
| AK. Skate | | 3 | 22.40 | 0 | Halibut Injury - Seg 4 | | | | | | | | | | | | |
| Aleutian Skate | | 2 | 10.75 | 0 | | | | | | | | | | | | | |
| Bathyraja | | 18 | 0 | 0 | PCod - (163) D/O L=3 Pollock - (37) D/O L=2 | | | | | | | | | | | | |
| Arrowtooth | | 4 | 3.21 | 0 | Bathyraja - <input checked="" type="checkbox"/> <input checked="" type="checkbox"/> <input checked="" type="checkbox"/> <input checked="" type="checkbox"/> U (23) | | | | | | | | | | | | |
| Kamchatka | | 1 | .86 | 0 | Kam/Arrow - <input checked="" type="checkbox"/> <input checked="" type="checkbox"/> <input checked="" type="checkbox"/> (9) | | | | | | | | | | | | |
| Kam/Arrow | | 14 | 0 | 0 | Flathead Sole - <input checked="" type="checkbox"/> <input checked="" type="checkbox"/> <input checked="" type="checkbox"/> L (7) | | | | | | | | | | | | |
| Flathead Sole | | 5 | 3.15 | 0 | Rock Sole - <input checked="" type="checkbox"/> <input checked="" type="checkbox"/> <input checked="" type="checkbox"/> L (17) I. Lord - L (2) | | | | | | | | | | | | |
| Flathead Sole | | 12 | 0 | 0 | Sea Whip - U (3) | | | | | | | | | | | | |
| Northern R.S. | | 5 | 3.70 | 0 | Sculpin - <input checked="" type="checkbox"/> U (8) | | | | | | | | | | | | |

The tally keypunch and species # keypunch must match.

For each species the number of weighed fish is subtracted from the number tallied in the sample. The remaining number of tally fish are reported in another line with zero weight. For each species, the number sum for all entries of that species must equal the tally number for that species.

Tally K/P
295

| | | | | |
|---------------------------------|--------------------------------|--------------|------------------------|---|
| Sample #: | Sub-Sample #: | Sample Size: | Kgs Sogmona pots | # of Sampled Hooks: |
| Presorted <input type="radio"/> | Combined <input type="radio"/> | | | No Fish in Sample <input type="radio"/> |

| Species | Sex | # | Weight | % ret. | Length, viability, injury, specimen, tally data, measurements, bird observations, sample design, notes: |
|----------------------|-----|----|--------|--------|---|
| ----- KEYPUNCH ----- | | | | | |
| Rock Sole U. | | 12 | 0 | 0 | Halibut |
| Sea Whip | | 1 | .02 | 0 | 50- L- 3 |
| Sea Whip | | 1 | .15 | 0 | 60- 1- 1 |
| Sea Whip | | 1 | 0 | 0 | 70- |
| Great Sculpin | | 5 | 10.73 | 0 | 80- <input checked="" type="checkbox"/> - 5 |
| Sculpin U. | | 3 | 0 | 0 | 90- |
| Yellow I. L. | | 2 | 1.80 | 0 | (9) @ 37.08 |
| Halibut | | 9 | 37.08 | 0 | |

Halibut are tallied by estimated length, and their weight is determined from the Halibut Worksheet in ATLAS.

Tally K/P
Ver. 2016

Figure 8-7: Example of Completed Raw Data From a Longline Vessel (Part 2)

LONGLINE COMPOSITION SAMPLING : LONGLINE DECK FORM EXAMPLES

| DECK FORM | | | | | Page <u>3</u> of _____ for Vessel/Plant | | | | | | | | | | | | | | |
|--|-------------------------------------|--------------|-------------------|---|---|---|---|----------------|------|------|------|------|----------------|------|------|----------------|------|------|--|
| Date | Cruise | Permit | Haul No. | Offload No. | Page <u>2</u> of _____ for Haul/Offload | | | | | | | | | | | | | | |
| 4/06/23 | 28500 | 6636 | 102 | | | | | | | | | | | | | | | | |
| Sample #: <u>1</u> | Sub-Sample #: <u>101</u> | Sample Size: | Kgs Segments pots | # of Sampled Hooks: | | | | | | | | | | | | | | | |
| Presorted <input type="radio"/> | Combined <input type="radio"/> | | | No Fish in Sample <input type="radio"/> | | | | | | | | | | | | | | | |
| Species | Sex | # | Weight | % ret. | Length, viability, injury, specimen, tally data, measurements, bird observations, sample design, notes: | | | | | | | | | | | | | | |
| -----KEYPUNCH----- | <input checked="" type="checkbox"/> | | | <input checked="" type="checkbox"/> | | | | | | | | | | | | | | | |
| P. Cod | | <u>20</u> | <u>83.86</u> | | <p style="text-align: center;"><u>PCod S/L</u></p> <table border="1" style="margin-left: auto; margin-right: auto;"> <thead> <tr> <th>M</th> <th>F</th> </tr> </thead> <tbody> <tr> <td><u>(53)</u>-□</td> <td>54-L</td> </tr> <tr> <td>55-1</td> <td>55-1</td> </tr> <tr> <td>56-U</td> <td><u>(65)</u>-L</td> </tr> <tr> <td>63-1</td> <td>68-1</td> </tr> <tr> <td><u>(66)</u>-L</td> <td>69-L</td> </tr> <tr> <td>70-1</td> <td></td> </tr> </tbody> </table> <p style="text-align: center;"><u>PCod Oto's</u></p> <p>Sp# 2 - M/53/2.4 #521630 Sp# 3 - F/65/4.6 #521631-spawning Sp# 4 - M/66/4.3 #521632</p> | M | F | <u>(53)</u> -□ | 54-L | 55-1 | 55-1 | 56-U | <u>(65)</u> -L | 63-1 | 68-1 | <u>(66)</u> -L | 69-L | 70-1 | |
| M | F | | | | | | | | | | | | | | | | | | |
| <u>(53)</u> -□ | 54-L | | | | | | | | | | | | | | | | | | |
| 55-1 | 55-1 | | | | | | | | | | | | | | | | | | |
| 56-U | <u>(65)</u> -L | | | | | | | | | | | | | | | | | | |
| 63-1 | 68-1 | | | | | | | | | | | | | | | | | | |
| <u>(66)</u> -L | 69-L | | | | | | | | | | | | | | | | | | |
| 70-1 | | | | | | | | | | | | | | | | | | | |
| P. Cod | | <u>9</u> | <u>39.70</u> | <u>94</u> | | | | | | | | | | | | | | | |
| P. Cod | | <u>11</u> | <u>44.16</u> | <u>94</u> | | | | | | | | | | | | | | | |
| | | | | | | | | | | | | | | | | | | | |
| | | | | | | | | | | | | | | | | | | | |
| | | | | | | | | | | | | | | | | | | | |
| | | | | | | | | | | | | | | | | | | | |
| | | | | | | | | | | | | | | | | | | | |
| | | | | | | | | | | | | | | | | | | | |
| | | | | | | | | | | | | | | | | | | | |
| <div style="border: 1px solid black; padding: 5px; display: inline-block;"> Predominant species weight fish are collected outside the tally period and reported as a subsample. </div> | | | | | | | | | | | | | | | | | | | |
| <div style="border: 1px solid black; padding: 5px; display: inline-block;"> Percent retained for Pacific Cod and Pollock were calculated after sample 2 and sample 3 were completed </div> | | | | | | | | | | | | | | | | | | | |
| Sample #: | Sub-Sample #: | Sample Size: | Kgs Segments pots | # of Sampled Hooks: | | | | | | | | | | | | | | | |
| Presorted <input type="radio"/> | Combined <input type="radio"/> | | | No Fish in Sample <input type="radio"/> | | | | | | | | | | | | | | | |
| Species | Sex | # | Weight | % ret. | Length, viability, injury, specimen, tally data, measurements, bird observations, sample design, notes: | | | | | | | | | | | | | | |
| -----KEYPUNCH----- | <input checked="" type="checkbox"/> | | | <input checked="" type="checkbox"/> | | | | | | | | | | | | | | | |
| | | | | | <p style="text-align: center;"><u>Halibut Injury (Haul Level)</u></p> <p style="text-align: right;">seg 4</p> <p>51-minor 63-moderate 82-minor 49-minor 76-severe 65-moderate 72-moderate 86-minor</p> | | | | | | | | | | | | | | |
| | | | | | | | | | | | | | | | | | | | |
| | | | | | | | | | | | | | | | | | | | |
| | | | | | | | | | | | | | | | | | | | |
| | | | | | | | | | | | | | | | | | | | |
| | | | | | | | | | | | | | | | | | | | |
| | | | | | | | | | | | | | | | | | | | |
| | | | | | | | | | | | | | | | | | | | |
| | | | | | | | | | | | | | | | | | | | |
| | | | | | | | | | | | | | | | | | | | |
| | | | | | | | | | | | | | | | | | | | |
| | | | | | | | | | | | | | | | | | | | |

Figure 8-8: Example of Sub-Sample Raw Data From a Longliner

DECK FORM

| | | | | | |
|----------|--------|--------|----------|-------------|---|
| Date | Cruise | Permit | Haul No. | Offload No. | Page <u>1</u> of _____ for Vessel/Plant |
| 06/15/23 | 36200 | 1113 | 46 | | Page <u>1</u> of _____ for Haul/Offload |

| | | | | |
|---------------------------------|--------------------------------|--------------------------|-------------------|---|
| Sample #: <u>1</u> | Sub-Sample #: _____ | Sample Size: <u>3.00</u> | Kgs Segments pots | # of Sampled Hooks: |
| Presorted <input type="radio"/> | Combined <input type="radio"/> | | | No Fish in Sample <input type="radio"/> |

| Species | Sex | # | Weight | % ret. | Length, viability, injury, specimen, tally data, measurements, bird observations, sample design, notes: |
|----------------------|-----|-----|--------|--------|---|
| ----- KEYPUNCH ----- | X | 227 | 152.38 | X | |
| Black Cod | | 126 | 0 | 96 | 26seg x 1/3 = 9seg / 3samples = 3seg/unit 26seg ÷ 3seg/unit = 8.6units RN=2 5/L RN=2 1-3 4-6 7-9 10-12 13-15 16-18 19-21 22-24 25-26 51 52 5/L 53 Halibut Injury - Seg 17 Blackcod (126) D/O <input type="checkbox"/> L=7 Bathyraja (26) Kam / Arrow <input type="checkbox"/> <input type="checkbox"/> (9) Shortspine TH <input type="checkbox"/> <input type="checkbox"/> <input type="checkbox"/> L (17) Spiny Dogfish <input type="checkbox"/> <input type="checkbox"/> <input type="checkbox"/> <input type="checkbox"/> <input type="checkbox"/> (25) Giant Grenadier <input type="checkbox"/> (5) |
| Commander Skate | | 4 | 13.60 | 0 | |
| Whitebrow Skate | | 1 | 2.95 | 0 | |
| Bathyraja | | 21 | 0 | 0 | |
| Arrowtooth | | 5 | 8.80 | 0 | |
| Kam / Arrow | | 4 | 0 | 0 | |
| Shortspine TH | | 5 | 2.76 | 0 | |
| Shortspine TH | | 12 | 0 | 0 | |
| Spiny Dogfish | | 5 | 6.10 | 0 | |
| Spiny Dogfish | | 20 | 0 | 0 | |
| Giant Grenadier | | 5 | 15.70 | 0 | |
| Halibut | | 19 | 102.47 | 38 | Tally K/P 227 |

| | | | | |
|---------------------------------|--------------------------------|--------------------|-------------------|---|
| Sample #: <u>1</u> | Sub-Sample #: <u>101</u> | Sample Size: _____ | Kgs Segments pots | # of Sampled Hooks: |
| Presorted <input type="radio"/> | Combined <input type="radio"/> | | | No Fish in Sample <input type="radio"/> |

| Species | Sex | # | Weight | % ret. | Length, viability, injury, specimen, tally data, measurements, bird observations, sample design, notes: |
|----------------------|-----|----|--------|--------|---|
| ----- KEYPUNCH ----- | X | 20 | 54.80 | X | |
| Blackcod | | 10 | 26.20 | 96 | Halibut D/O <input type="checkbox"/> <input type="checkbox"/> =10 50 60 - L - 3 70 - <input type="checkbox"/> L - 7 80 - <input type="checkbox"/> L - 6 90 - L - 2 100 - L - 1 (19) @ 102.47 |
| Black Cod | | 10 | 28.60 | 96 | |
| | | | | | |
| | | | | | |

See "Species Identification Rules" on page 8-13 for discussion of the species you can and cannot ID to species off the line! In this example, thornyheads not in hand were reported to species as Shortspine Thornyheads because you are allowed to do so if no Longspine individuals are in the subset sample. *Keep in mind that there are different rules for different species.*

| | | | | | |
|--|--|--|--|--|--|
| | | | | | |
| | | | | | |
| | | | | | |

Tally K/P
 Ver. 2016

Figure 8-9: Example of Sample and Sub-Sample Raw Data from a Catcher Longliner Fishing for Sablefish

DECK FORM

| | | | | | |
|----------|--------|--------|----------|-------------|---|
| Date | Cruise | Permit | Haul No. | Offload No. | Page <u>2</u> of _____ for Vessel/Plant |
| 06/15/23 | 36200 | 1113 | 46 | | Page <u>2</u> of _____ for Haul/Offload |

| | | | | |
|---------------------------------|--------------------------------|--------------------------|-------------------------|---|
| Sample #: <u>2</u> | Sub-Sample #: _____ | Sample Size: <u>3.00</u> | Kgs Segments pots | # of Sampled Hooks: <u>272</u> |
| Presorted <input type="radio"/> | Combined <input type="radio"/> | | | No Fish in Sample <input type="radio"/> |

| Species | Sex | # | Weight | % ret. | Length, viability, injury, specimen, tally data, measurements, bird observations, sample design, notes: |
|--------------------|-------------------------------------|------------|--------------|-------------------------------------|--|
| -----KEYPUNCH----- | <input checked="" type="checkbox"/> | <u>147</u> | <u>64.25</u> | <input checked="" type="checkbox"/> | Black Cod - (76) D/O L-2 |
| Blackcod | | <u>76</u> | <u>0</u> | <u>96</u> | Bathyraja - (21) |
| Whitebrow Skate | | <u>5</u> | <u>15.60</u> | <u>0</u> | Kam/Arrow - <input checked="" type="checkbox"/> <input checked="" type="checkbox"/> <input checked="" type="checkbox"/> <input checked="" type="checkbox"/> (20) |
| Bathyraja | | <u>16</u> | <u>0</u> | <u>0</u> | Shortspine TH - <input checked="" type="checkbox"/> (5) |
| Shortspine TH | | <u>5</u> | <u>3.10</u> | <u>0</u> | SR/RE - <input checked="" type="checkbox"/> <input checked="" type="checkbox"/> <input checked="" type="checkbox"/> <input checked="" type="checkbox"/> (18) |
| Shortraker RF | | <u>2</u> | <u>5.63</u> | <u>0</u> | King Crab - L (2) |
| Rougheye RF | | <u>4</u> | <u>12.40</u> | <u>0</u> | Halibut D/O <input checked="" type="checkbox"/> = 5 |
| SR/RE | | <u>12</u> | <u>0</u> | <u>0</u> | 50- |
| Cousei King | <u>M</u> | <u>2</u> | <u>1.65</u> | <u>0</u> | 60-1-1 |
| Arrowtooth | | <u>5</u> | <u>7.54</u> | <u>0</u> | 70- <input checked="" type="checkbox"/> -4 |
| Kam/Arrow | | <u>15</u> | <u>0</u> | <u>0</u> | 80- |
| Halibut | | <u>5</u> | <u>18.33</u> | <u>38</u> | 90- |
| | | | | | 100- |
| | | | | | (5) @ 18.33 |

* Mixed Gear calc.
25able
1 HBT
2x99=198
1x74.4=74.4
Σ272.4 hooks

Cousei King s/L

| | |
|-------|-------|
| M | F |
| 123-1 | 118-1 |

Tally K/P

147

| | | | | |
|---------------------------------|--------------------------------|--------------------|-------------------------|---|
| Sample #: <u>2</u> | Sub-Sample #: <u>201</u> | Sample Size: _____ | Kgs Segments pots | # of Sampled Hooks: _____ |
| Presorted <input type="radio"/> | Combined <input type="radio"/> | | | No Fish in Sample <input type="radio"/> |

| Species | Sex | # | Weight | % ret. | Length, viability, injury, specimen, tally data, measurements, bird observations, sample design, notes: |
|--------------------|-------------------------------------|-----------|--------------|-------------------------------------|---|
| -----KEYPUNCH----- | <input checked="" type="checkbox"/> | <u>20</u> | <u>80.50</u> | <input checked="" type="checkbox"/> | Blackcod s/L |
| Blackcod | | <u>9</u> | <u>35.40</u> | <u>96</u> | M F |
| Blackcod | | <u>11</u> | <u>45.10</u> | <u>96</u> | 50-1 48-1 |
| | | | | | 51-1 50-1 |
| | | | | | 52-1 (51)-1 |
| | | | | | (54)-L 54-1 |
| | | | | | 57-L 58-1 |
| | | | | | 58-1 (60)-L |
| | | | | | 61-L |
| | | | | | 63-L |
| | | | | | Blackcod oto's |
| | | | | | sp#1 M/54/1.65 |
| | | | | | #146212 |
| | | | | | sp#2 F/60/2.51 |
| | | | | | #146213 |
| | | | | | sp#3 F/51/1.02 |
| | | | | | #146214 |

Percent retained must be the same by species for all samples within a haul. See Figure 8-11 for Blackcod and Halibut percent retained calculation.

From sample 2 Shortraker s/L

| | |
|------|--------|
| M | F |
| 50-1 | (52)-1 |

Rougheye s/L

| | |
|------|--------|
| M | F |
| 59-1 | 60-1 |
| | (62)-1 |
| | 65-1 |

Shortraker oto's

sp#4 F/52/2.27
#146210

Rougheye oto's

sp#5 F/62/2.91
#146209

Tally K/P

Ver. 2016

Figure 8-10: Example of Sample Raw Data From a Catcher Longliner Fishing for Sablefish (continued)

DECK FORM

| | | | | | |
|----------|--------|--------|----------|-------------|---|
| Date | Cruise | Permit | Haul No. | Offload No. | Page <u>3</u> of _____ for Vessel/Plant |
| 06/15/23 | 36200 | 1113 | 46 | | Page <u>3</u> of _____ for Haul/Offload |

| | | | | |
|---------------------------------|--------------------------------|--------------------------|--|--|
| Sample #: <u>3</u> | Sub-Sample #: | Sample Size: <u>3.00</u> | <small>Kgs segments pots</small> | # of Sampled Hooks: |
| Presorted <input type="radio"/> | Combined <input type="radio"/> | | | No Fish in Sample <input checked="" type="radio"/> |

| Species | Sex | # | Weight | % ret. | Length, viability, injury, specimen, tally data, measurements, bird observations, sample design, notes: |
|--------------------|-----|---|--------|--------|---|
| -----KEYPUNCH----- | X | | | X | Blackcod-0 D/O |
| | | | | | Bathyraja-0 |
| | | | | | Kam/Arrow-0 |
| | | | | | Shortspine TH-0 |
| | | | | | * No Fish * |
| | | | | | Halibut D/O |
| | | | | | 50- |
| | | | | | 60- |
| | | | | | 70- |
| | | | | | 80- |
| | | | | | 90- |
| | | | | | 100- |

Tally K/P

| | | | | |
|---------------------------------|--------------------------------|--------------|--|---|
| Sample #: | Sub-Sample #: | Sample Size: | <small>Kgs Segments pots</small> | # of Sampled Hooks: |
| Presorted <input type="radio"/> | Combined <input type="radio"/> | | | No Fish in Sample <input type="radio"/> |

| Species | Sex | # | Weight | % ret. | Length, viability, injury, specimen, tally data, measurements, bird observations, sample design, notes: |
|--------------------|-----|---|--------|--------|---|
| -----KEYPUNCH----- | X | | | X | %. Rtn'd Haul 46 |
| | | | | | <u>Blackcod</u> |
| | | | | | # D/O |
| | | | | | 126 7 |
| | | | | | 76 2 |
| | | | | | 202 9 |
| | | | | | (202-9) |
| | | | | | 202 |
| | | | | | = .955445544 |
| | | | | | × 100 |
| | | | | | = 96% |
| | | | | | <u>Halibut</u> |
| | | | | | # D/O |
| | | | | | 19 10 |
| | | | | | 5 5 |
| | | | | | 24 15 |
| | | | | | (24-15) |
| | | | | | 24 |
| | | | | | = .375 × 100 |
| | | | | | = 38% |

Tally K/P

Ver. 2016

Figure 8-11: Example of Sample Raw Data From a Catcher Longliner Fishing for Sablefish with No Fish in Sample (continued)

DECK FORM

| Date | Cruise | Permit | Haul No. | Offload No. |
|----------|--------|--------|----------|-------------|
| 07/06/23 | 23456 | 7891 | 2 | |

Page 4 of _____ for Vessel/Plant

Page 1 of 2 for Haul/Offload

| Sample #: <u>1</u> | Sub-Sample #: | Sample Size: <u>.01</u> | <input checked="" type="radio"/> Kgs Segments pots | # of Sampled Hooks: <u>93</u> ← | |
|---------------------------------|-------------------------------------|---|--|-------------------------------------|--|
| Presorted <input type="radio"/> | Combined <input type="radio"/> | Unable to Follow Design <input type="radio"/> | No Fish in Sample <input type="radio"/> | | |
| Species | Sex | # | Weight | % ret. | Length, viability, injury, specimen, tally data, measurements, bird observations, sample design, notes: $840 \text{ hks} \times \frac{1}{3} = 280 \text{ hks} / 3 \text{ samples} = 93 \text{ hks/unit}$ $840 \text{ hks} \div 93 \text{ hks/unit} = 9 \text{ units RN}(0-2) = 1$ $\text{Retrieval time} = 60 \text{ min} / 9 \text{ units} = 6.66 \text{ min/unit}$ $S1 = 1 \times 6.66 = 6.66 (6.66 \times 60) = 6 \text{ min } 40 \text{ sec}$ $S2 = 4 \times 6.66 = 26.66 (26.66 \times 60) = 26 \text{ min } 40 \text{ sec}$ $S3 = 7 \times 6.66 = 46.66 (46.66 \times 60) = 46 \text{ min } 40 \text{ sec}$ Sablefish - L(2) D/O-1 Halibut injuries @ 10min Bathyrāja - L(3) SR/RE - L(2) Coral Unid. L(3) Halibut D/O - <input checked="" type="checkbox"/> L 50-L-2 90- <input checked="" type="checkbox"/> 9 60-1-1 100- <input checked="" type="checkbox"/> 5 70- <input checked="" type="checkbox"/> 4 120-1-1 80-L-3 150-1-1 <u>(26) @ 256.89</u> |
| ----- KEYPUNCH ----- | <input checked="" type="checkbox"/> | <u>36</u> | <u>273.09</u> | <input checked="" type="checkbox"/> | |
| Sablefish | | <u>1</u> | <u>2.4</u> | <u>80</u> | |
| Sablefish | | <u>1</u> | <u>0</u> | <u>80</u> | |
| Whitebrow SKT | | <u>1</u> | <u>5.4</u> | <u>0</u> | |
| Bathyrāja | | <u>2</u> | <u>0</u> | <u>0</u> | |
| Shortraker | | <u>2</u> | <u>8.0</u> | <u>100</u> | |
| Hydrocoral | | <u>1</u> | <u>1.0</u> | <u>0</u> | |
| Hydrocoral | | <u>1</u> | <u>.2</u> | <u>0</u> | |
| Hydrocoral | | <u>1</u> | <u>.1</u> | <u>0</u> | |
| Halibut | | <u>26</u> | <u>256.89</u> | <u>65</u> | |

*Total hooks sampled - 93

Every hook was tallied during the tally period to obtain # of hooks sampled.

| Sample #: | Sub-Sample #: | Sample Size: | <input type="radio"/> Kgs Segments pots | # of Sampled Hooks: | | | | | | | |
|---------------------------------|-------------------------------------|---|---|-------------------------------------|---|---|---|--------|--|--------|--|
| Presorted <input type="radio"/> | Combined <input type="radio"/> | Unable to Follow Design <input type="radio"/> | No Fish in Sample <input type="radio"/> | | | | | | | | |
| Species | Sex | # | Weight | % ret. | Length, viability, injury, specimen, tally data, measurements, bird observations, sample design, notes: Shortraker S/L <table border="1"> <tr> <td>M</td> <td>F</td> </tr> <tr> <td>(52)-1</td> <td></td> </tr> <tr> <td>(61)-1</td> <td></td> </tr> </table> (from Sample 1) Shortraker Oto's sp#5 - F/52/3.6 #846121 sp#6 - F/61/4.4 #846122 Halibut Injury (Haul level) 101-U 100-U 84-U 41-minor 146-U 136-U 153-U 65-minor 63-minor 90-U | M | F | (52)-1 | | (61)-1 | |
| M | F | | | | | | | | | | |
| (52)-1 | | | | | | | | | | | |
| (61)-1 | | | | | | | | | | | |
| ----- KEYPUNCH ----- | <input checked="" type="checkbox"/> | | | <input checked="" type="checkbox"/> | | | | | | | |
| | | | | | | | | | | | |
| | | | | | | | | | | | |
| | | | | | | | | | | | |
| | | | | | | | | | | | |
| | | | | | | | | | | | |
| | | | | | | | | | | | |
| | | | | | | | | | | | |
| | | | | | | | | | | | |

Halibut Injury Assessments: Unsorted halibut were collected during a non-tally period. Non-retained halibut were assessed for injuries before discard. Retained halibut were recorded with injury assessment as "U" (unknown). Do not record individual weights on the for injury assessment halibut.

Tally K/P

Figure 8-12: Example of Deck Form for Halibut Longliner Snap gear Sample and Halibut Injury Assessments

DECK FORM

| | | | | |
|----------|--------|--------|----------|-------------|
| Date | Cruise | Permit | Haul No. | Offload No. |
| 07/06/23 | 23456 | 7891 | 2 | |

Page 5 of _____ for Vessel/Plant

Page 2 of 2 for Haul/Offload

| Sample #: 2 | Sub-Sample #: | Sample Size: .01 | <input checked="" type="radio"/> Kgs Segments pots | # of Sampled Hooks: 93 |
|--|-------------------------------------|---|--|-------------------------------------|
| Presorted <input type="radio"/> | Combined <input type="radio"/> | Unable to Follow Design <input type="radio"/> | No Fish in Sample <input type="radio"/> | |
| Species | Sex | # | Weight | % ret. |
| ----- KEYPUNCH ----- | <input checked="" type="checkbox"/> | 45 | 260.82 | <input checked="" type="checkbox"/> |
| Sablefish | | 4 | 10.7 | 80 |
| Sablefish | | 1 | 0 | 80 |
| Giant Grenadier | | 5 | 16.1 | 0 |
| Giant Grenadier | | 1 | 0 | 0 |
| Arrowtooth Fl | | 3 | 4.8 | 0 |
| Halibut | | 31 | 229.22 | 65 |
| Length, viability, injury, specimen, tally data, measurements, bird observations, sample design, notes: Sablefish - <input checked="" type="checkbox"/> (5) D/O-1 Bathyrja - 0 Giant G. - <input checked="" type="checkbox"/> (1) (6) Kam/Arrow - <input checked="" type="checkbox"/> (3) *Total Hooks sampled - 93 Halibut D/O- <input checked="" type="checkbox"/> <input checked="" type="checkbox"/> <input checked="" type="checkbox"/> 50- <input checked="" type="checkbox"/> -4 110-1-1 60- <input checked="" type="checkbox"/> -3 120-1-1 70- <input checked="" type="checkbox"/> -5 80- <input checked="" type="checkbox"/> -5 90- <input checked="" type="checkbox"/> -7 100- <input checked="" type="checkbox"/> -5 (31) @ 229.22 | | | | |
| | | | | Tally K/P |
| | | | | 45 |

| Sample #: 3 | Sub-Sample #: | Sample Size: .01 | <input checked="" type="radio"/> Kgs Segments pots | # of Sampled Hooks: 93 | | | | | | | | | | | | | | | | | | | | | | | | | | | | | | | | | | | | | | | | |
|--|-------------------------------------|---|--|-------------------------------------|---|-----|-------|---|-------|----|-------|---|-------|--|----|----|-------|--|-------|-------|----|--|-------|--|-----------------|--|---|-----|------|---|------|---|------|---|-------|--|----|---|-------|--|------|-------------------|----|--|
| Presorted <input type="radio"/> | Combined <input type="radio"/> | Unable to Follow Design <input type="radio"/> | No Fish in Sample <input type="radio"/> | | | | | | | | | | | | | | | | | | | | | | | | | | | | | | | | | | | | | | | | | |
| Species | Sex | # | Weight | % ret. | | | | | | | | | | | | | | | | | | | | | | | | | | | | | | | | | | | | | | | | |
| ----- KEYPUNCH ----- | <input checked="" type="checkbox"/> | 30 | 188.48 | <input checked="" type="checkbox"/> | | | | | | | | | | | | | | | | | | | | | | | | | | | | | | | | | | | | | | | | |
| Sablefish | | 3 | 7.7 | 80 | | | | | | | | | | | | | | | | | | | | | | | | | | | | | | | | | | | | | | | | |
| Giant Grenadier | | 2 | 6.3 | 0 | | | | | | | | | | | | | | | | | | | | | | | | | | | | | | | | | | | | | | | | |
| Commander skt | | 1 | 12.1 | 0 | | | | | | | | | | | | | | | | | | | | | | | | | | | | | | | | | | | | | | | | |
| Commander SKt | | 1 | 9.9 | 0 | | | | | | | | | | | | | | | | | | | | | | | | | | | | | | | | | | | | | | | | |
| Halibut | | 23 | 152.48 | 65 | | | | | | | | | | | | | | | | | | | | | | | | | | | | | | | | | | | | | | | | |
| Length, viability, injury, specimen, tally data, measurements, bird observations, sample design, notes: Sablefish - <input checked="" type="checkbox"/> (3) D/O- Giant G - <input checked="" type="checkbox"/> (2) Bathyrja - 1- <input checked="" type="checkbox"/> *Total Hooks sampled - 93 Halibut D/O- <input checked="" type="checkbox"/> <input checked="" type="checkbox"/> 50- <input checked="" type="checkbox"/> -3 100- <input checked="" type="checkbox"/> -2 60- <input checked="" type="checkbox"/> -2 130-1-1 70- <input checked="" type="checkbox"/> -3 80- <input checked="" type="checkbox"/> -6 100- <input checked="" type="checkbox"/> -2 90- <input checked="" type="checkbox"/> -5 130-1-1 (23) @ 152.48 Halibut % Rtn'd (H2) <table border="1"> <tr><th>#</th><th>D/O</th></tr> <tr><td>51-26</td><td>8</td></tr> <tr><td>52-31</td><td>11</td></tr> <tr><td>53-23</td><td>9</td></tr> <tr><td colspan="2"><hr/></td></tr> <tr><td>80</td><td>28</td></tr> <tr><td colspan="2"><hr/></td></tr> <tr><td>80-28</td><td>= .65</td></tr> <tr><td>80</td><td></td></tr> <tr><td colspan="2"><hr/></td></tr> <tr><td colspan="2">.65 x 100 = 65%</td></tr> </table> Sablefish % Rtn'd (H2) <table border="1"> <tr><th>#</th><th>D/O</th></tr> <tr><td>51-2</td><td>1</td></tr> <tr><td>52-5</td><td>1</td></tr> <tr><td>53-3</td><td>0</td></tr> <tr><td colspan="2"><hr/></td></tr> <tr><td>10</td><td>2</td></tr> <tr><td colspan="2"><hr/></td></tr> <tr><td>10-2</td><td>= .80 x 100 = 80%</td></tr> <tr><td>10</td><td></td></tr> </table> | | | | | # | D/O | 51-26 | 8 | 52-31 | 11 | 53-23 | 9 | <hr/> | | 80 | 28 | <hr/> | | 80-28 | = .65 | 80 | | <hr/> | | .65 x 100 = 65% | | # | D/O | 51-2 | 1 | 52-5 | 1 | 53-3 | 0 | <hr/> | | 10 | 2 | <hr/> | | 10-2 | = .80 x 100 = 80% | 10 | |
| # | D/O | | | | | | | | | | | | | | | | | | | | | | | | | | | | | | | | | | | | | | | | | | | |
| 51-26 | 8 | | | | | | | | | | | | | | | | | | | | | | | | | | | | | | | | | | | | | | | | | | | |
| 52-31 | 11 | | | | | | | | | | | | | | | | | | | | | | | | | | | | | | | | | | | | | | | | | | | |
| 53-23 | 9 | | | | | | | | | | | | | | | | | | | | | | | | | | | | | | | | | | | | | | | | | | | |
| <hr/> | | | | | | | | | | | | | | | | | | | | | | | | | | | | | | | | | | | | | | | | | | | | |
| 80 | 28 | | | | | | | | | | | | | | | | | | | | | | | | | | | | | | | | | | | | | | | | | | | |
| <hr/> | | | | | | | | | | | | | | | | | | | | | | | | | | | | | | | | | | | | | | | | | | | | |
| 80-28 | = .65 | | | | | | | | | | | | | | | | | | | | | | | | | | | | | | | | | | | | | | | | | | | |
| 80 | | | | | | | | | | | | | | | | | | | | | | | | | | | | | | | | | | | | | | | | | | | | |
| <hr/> | | | | | | | | | | | | | | | | | | | | | | | | | | | | | | | | | | | | | | | | | | | | |
| .65 x 100 = 65% | | | | | | | | | | | | | | | | | | | | | | | | | | | | | | | | | | | | | | | | | | | | |
| # | D/O | | | | | | | | | | | | | | | | | | | | | | | | | | | | | | | | | | | | | | | | | | | |
| 51-2 | 1 | | | | | | | | | | | | | | | | | | | | | | | | | | | | | | | | | | | | | | | | | | | |
| 52-5 | 1 | | | | | | | | | | | | | | | | | | | | | | | | | | | | | | | | | | | | | | | | | | | |
| 53-3 | 0 | | | | | | | | | | | | | | | | | | | | | | | | | | | | | | | | | | | | | | | | | | | |
| <hr/> | | | | | | | | | | | | | | | | | | | | | | | | | | | | | | | | | | | | | | | | | | | | |
| 10 | 2 | | | | | | | | | | | | | | | | | | | | | | | | | | | | | | | | | | | | | | | | | | | |
| <hr/> | | | | | | | | | | | | | | | | | | | | | | | | | | | | | | | | | | | | | | | | | | | | |
| 10-2 | = .80 x 100 = 80% | | | | | | | | | | | | | | | | | | | | | | | | | | | | | | | | | | | | | | | | | | | |
| 10 | | | | | | | | | | | | | | | | | | | | | | | | | | | | | | | | | | | | | | | | | | | | |
| | | | | Tally K/P | | | | | | | | | | | | | | | | | | | | | | | | | | | | | | | | | | | | | | | | |
| | | | | 30 | | | | | | | | | | | | | | | | | | | | | | | | | | | | | | | | | | | | | | | | |

Figure 18-13: Example of Deck Form for Halibut Longliner Snap Gear Samples and Percent Retained Calculation

This page intentionally left blank

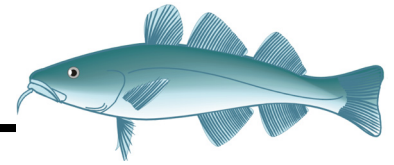

POT VESSEL CATCH DATA

Table of Contents

| | |
|---|-----|
| Priorities | 9-1 |
| Safety Concerns on Pot Vessels | 9-1 |
| Pot Fishing Operations | 9-2 |
| Recording Fishing Effort Data | 9-4 |
| Vessels Fishing IFQ or CDQ | 9-4 |
| Vessels Under 60ft | 9-4 |
| Verifying Total Pots | 9-5 |
| Verifying Pot Type | 9-6 |
| Verifying Fishing Method - Single Pots or Strung Pots | 9-6 |
| Verifying Deployment and Retrieval Information | 9-6 |
| Date and Time of Gear Deployment/Retrieval | 9-6 |
| Position of Gear Deployment and Position of Gear Retrieval - Latitude and Longitude | 9-6 |
| Estimating Discards | 9-6 |
| Pot Opening Data | 9-7 |
| Offload Data for Pot Vessels | 9-8 |
| Determining Delivery Weight | 9-8 |
| Vessel Haul Form (VHF) for Pot Vessels | 9-8 |
| Observer Haul Form (OHF) for Pot Vessels | 9-8 |

PRIORITIES

- Your safety!
- Record the vessel’s total fishing effort for every set retrieved.
- Verify the number of pots in your samples and per set.
- Verify Pot Type and Fishing Method Information
- Collect Pot Opening Data
- Send data to the Observer Program as directed (see “Sending Data” on page 2-39).
- Document any compliance concerns.
- Record calculations and daily log book notes.

SAFETY CONCERNS ON POT VESSELS

On a pot vessel, all work is conducted on deck. Pot vessels have low rails over which the pots are lifted and moved to various locations. Waves can easily wash crew and gear overboard or cause a pot to break free and swing around or crash onto the deck. Be conscious of your surroundings at all times.

When you first arrive on a vessel, discuss with the deck boss or captain which area would best allow you to safely access the catch. The area needs to have a clear view of the pots as they leave the water and are emptied, but should be located out of danger from swinging pots. You should never set up your sampling area directly across from the pot launcher. Discuss with the crew how best to collect samples. The best option may be to have the crew push full totes or swing the sorting table to you.

Regardless of how exposed your sample station is to the elements, the Observer Program expects you to be proactive about your own safety by wearing a personal flotation device whenever you are working on deck. You should always notify the captain or crew if you plan to be, or think you will be, out on deck alone.

Coordinate your activities around the movement of the pots. Be aware of coils of line attaching the buoys to the pot. These are deployed as the pot is launched and have been known to wrap around ankles and drag crew overboard. Pots may slip or jump from the launcher or may break free from ties on the stack. Pots can be very heavy, between 350 and 450 kg, and have crushed crew members. While sorting and weighing samples, check deck activity frequently and be attuned to the crew for danger warnings. Be aware of possible hazards and plan a safe response.

POT FISHING OPERATIONS

The National Marine Fisheries Service defines pot fishing as using a stationary, buoyed line attached to a single trap, or multiple traps attached to a groundline, for the purpose of capturing fish. Groundfish observers are typically deployed to monitor Pacific cod fisheries and some sablefish fisheries.

Pot Gear

Pots used to fish groundfish consist of mesh panels attached to a rigid or collapsible metal frame. These collapsible pots are commonly referred to as “slinky pots”. Pots can vary in shape and size. However, all pots function similarly. See figures 9-4 to 9-11 on page 9-10 for examples of the types of pots used in the North Pacific. Fish are attracted by bait placed inside the pot. Mesh tunnels on either side of a pot allow fish to enter, and either plastic “triggers” or the narrowing of the tunnels prevent them from escaping. Metal rings may be sewn into the mesh panels, these escape rings, allow smaller fish and crab to leave the pot. Twine or metal bars, known as halibut excluders, can be used to restrict the size of a tunnel entrance. This prevents large halibut from entering the pots while permitting the entry of smaller fish. Vessels fishing for CDQ or IFQ sablefish, which also hold CDQ or IFQ halibut quota, may retain halibut and are not required to limit the size of tunnel openings or use halibut excluders. Halibut excluders are required in all other pot groundfish fisheries. Pot gear can be deployed as single pots or strung pots.

Single Pot Gear

Single pots have one buoy line and buoy attached to each pot trap. Vessels using single pot gear will often deploy multiple single pots as a haul. These pots may be arranged in a row on the sea floor or may be deployed in clusters.

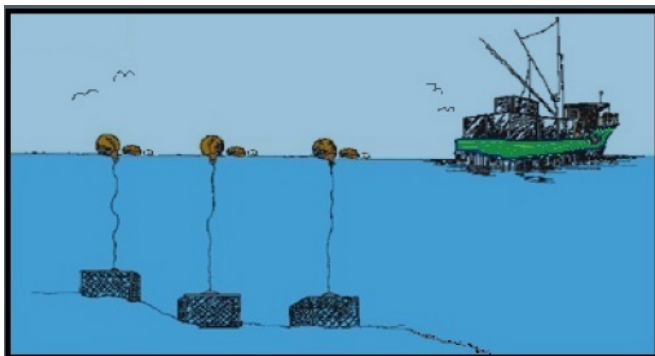

Figure 9.1: Vessel Fishing with Single Pot Gear

Setting

The decks of some pots vessels are equipped with launcher and crane. The launcher is a hydraulic lift located on the side of the vessel. To deploy a pot, the crew uses the crane to move a pot onto the launcher. A single line is attached to the pot, and the coil is set next to the launcher. The pot is baited, the doors shut, and the pot is “launched” over the side. The coil of line plays out as fast as the pot is sinking. A set of buoys are attached at the end of the line with the vessel’s permit number and often a pot number.

Retrieval

To retrieve a single pot, a crew member tosses a grappling hook to snag the buoys. The buoys are dragged on deck, and the line is placed into the rotating “block”. The block retrieves the line and pulls the pot from the water. When the pot reaches the side of the boat, the picking crane is hooked to the bridle. The pot is lifted and placed onto the launcher. The “dogs” on the sides of the launcher grab the pot and secure it. The angle of the launcher can then be adjusted to open the pot and dump the contents or to redeploy the pot.

Once the catch has been dumped from the pot into a tote or sorting table, the crew pulls the tote or table out of the way, sorts out the bycatch, bleeds the Pacific cod or removes the head of the sablefish, and throws the fish into the hold. Some sablefish vessels do not bleed their fish but store them live and deliver live fish to the processor.

If pots are to be redeployed, the bait bag is replaced, the doors are tied shut, and the launcher is lifted to slide the pot back into the water. If the pots are being stacked, the boom drags or lifts the pot to the back of the deck, where it is placed on the stack and secured by pot ties and chains.

Strung Pot Gear

Strung pots have one single groundline with multiple pots traps attached and a buoy line on one or more ends. Some vessels may refer to strung pots as longline pots.

Setting

To deploy a set of strung pots an anchor, flag pole, and set of buoys, are attached to the end of the groundline. While setting, multiple pots are attached to the ground line and as the groundline plays out, the crew drops bait through each pot’s mesh tunnel opening before it goes overboard. After all the pots are baited and deployed, the

other end of the groundline may be rigged, with another anchor, flag pole, and buoy, is sent overboard.

Retrieval

To retrieve strung pots, a crew member tosses a grappling hook to snag the buoys. The buoys are dragged on deck, and the line is placed into the rotating block. The block retrieves the line and pulls the groundline and attached pots from the water. When a pot reaches the side of the boat, a crewmember lifts it on to the vessel and detaches it from the groundline. Some vessels fishing with strung pots may use a picking hook, pot launcher, and hydraulic sorting table in retrieval process.

Once the pot is on board, the pot is dumped and the crew sorts out the bycatch, bleeds the Pacific cod or removes the head of the sablefish, and throws the fish into the hold. Some sablefish vessels do not bleed their fish but store them live and deliver live fish to the processor. Vessels fishing with strung pots typically retrieve the entire haul before the gear is redeployed.

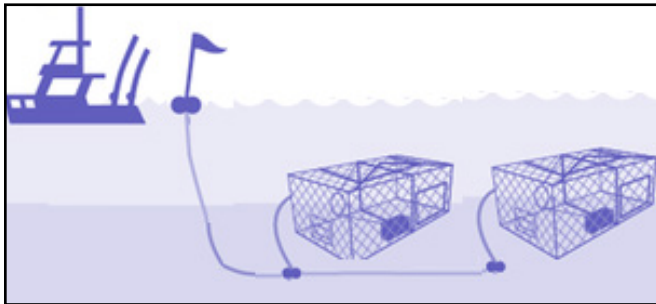

Figure 9.2: Vessel Fishing with Strung Pot Gear

Pot Hauls

Pots are deployed in units called hauls. Vessel crews may also refer to hauls as “strings” or “sets”. Captains use various means of recording the numbers and locations of pots in these hauls. Some captains record detailed data on location, depth, and soak time into the NMFS logbook for each haul, while others record the total numbers of pots retrieved in a day as one haul. *Regardless of which system the captain uses, it is important that you talk to the captain before fishing starts to determine how they delineate a haul. Having this information will help you decide which sampling design to employ and how to determine the vessel estimate.*

Before copying anything from the vessel logbook or captain’s notes to your data forms, you must verify that the data reported are accurate. Misunderstandings about

how the logbook is filled out are possible. Observers on pot boats may use a different haul designation system than that in the vessel logbook.

Single Pot Hauls

For single pot hauls, a computerized plotter is commonly used, to mark the latitude and longitude of each pot. Many captains also record the position of each pot in a personal notebook. Hauls can be viewed on the screen as points connected with lines, each point representing a single pot. If the haul is deployed as a cluster of pots each pot will be represented by single point on the plotter.

One of the greatest difficulties faced by observers on pot vessels fishing with single pots is determining what constitutes a haul. Captains may define hauls as individual pots, in groups of pots, or as a single, long row of pots. Pots within a designated row may be set at varying depths and areas and have different soak times. Try to obtain the most discrete data you can by working with the captain, consulting the plotter, and tracking the gear retrieval yourself. It may be necessary to designate all the pots retrieved within 24 hours as a single haul. However, this method does not yield the most discrete data. How you delineate a haul will be important in determining the vessel estimate and the sampling design to employ. Keeping these factors in mind, it is important to talk to the captain about this before fishing starts. Be sure to document any difficulties you encounter when determining strings on your vessel in your logbook.

Strung Pot Hauls

For strung pot hauls, a computerized plotter is commonly used, to mark the latitude and longitude the pots at each end of the groundline. Some captains may record the position of each pot in a personal notebook. Hauls can be viewed on the screen as lines.

For vessels fishing with strung pots, a haul is generally defined as all of the pots fixed to the groundline. If your vessel is defining strung pot hauls in another manner, document the situation in your logbook and notify your inseason advisor.

Vessels Fishing With Single Pots and Strung Pots

If you are deployed to a vessel that is fishing with both single pots and strung pots, it is generally advisable to list the strung pots and single pots as individual hauls. If you determine that is best to list strung pots and single pots

together as one haul, please consult with your inseason advisor

Delineating Hauls Independently From the Vessel

There may be instances where better data can be obtained if you break a single haul recorded by the vessel, into several separately recorded hauls or combine several hauls into one haul. This requires that you work closely with vessel personnel in order to record the correct deployment and retrieval data. You should undertake this endeavor only if you are sure it will increase the accuracy of your data, and that you are able to obtain the correct haul information. If you are deployed on a vessel fishing with strung pots, and you feel that it is necessary to use a different haul designation system than that in the vessel logbook, document the situation in your logbook and contact your inseason advisor.

RECORDING FISHING EFFORT DATA

Under regulation 50 CFR 679.51 (see “Records” on page 20-13), observers have the right to inspect and copy the vessel’s NMFS logbook. If the vessel is not required to keep an NMFS logbook, fishing information and other documentation of fishing effort must be available to the observer under “reasonable assistance” regulations.

Be aware that common errors on pot vessels include incorrectly recorded deployment/retrieval times and the total number of pots retrieved. You must verify that this information is being properly recorded and reported. Discrepancies between the logbook and your observations should be noted and discussed with the captain.

You are required to transfer the following information from the vessel logbook (if verified) or from other vessel catch documentation (the plotter, captain’s notebook, etc.) to the Vessel and Observer Haul Forms:

- Haul (Set) numbers. *If you are unable to make haul numbers match the ELB, contact your in-season advisor.*
- Community Development Quota (CDQ) group number, if applicable
- Date and Time of Gear Deployment
- Date and Time of Gear Retrieval
- Position of Gear Deployment (latitude and longitude)

- Position of Gear Retrieval (latitude and longitude)
- Average Bottom Depth.
- Vessel Estimate
- Number of Pots Retrieved. All pots retrieved with doors tied shut, regardless of whether they are baited or not, must be accounted for in catch effort data.
- If the vessel acts as a tender only and does not fish for itself, record non-fishing day positions only.

In addition, you need to record information on any problems associated with the retrieval of the pots in your logbook. This information is not recorded in the vessel logbook. Ask the person responsible for entering information in the vessel’s logbook to record missing pots or problems with pot retrieval somewhere on the logbook page or on a separate page for you. See Figure 9-14 on page 9-13 for paper-form examples of these types of data.

Vessels Fishing IFQ or CDQ

All longline and pot vessels (both IFQ and non-IFQ) use the same type of logbook. Data are entered differently depending on whether the vessel is fishing for IFQ species or not. Fishing IFQ is shown in the logbook by the IFQ permit number listed on the upper left-hand corner of the DCPL or DFL and an entry greater than 0.00 in the columns “CDQ/IFQ Halibut” and/or “IFQ Sablefish” (see Figure 7-2 on page 7-4). Look for both entries. Fixed gear vessels using electronic logbooks denote IFQ hauls in the management code column next to the set number (see Figure 7-3 on page 7-5). If you are unsure whether or not the vessel is fishing IFQ, consult with the captain. For a more detailed description of IFQ, see page 8-24.

For information about your duties during CDQ catcher processors, see “CDQ Specific Information for Fixed Gear Catcher/Processors” on page 8-25.

Vessels Under 60ft

Pot vessels under 60 feet are not required to use an NMFS logbook, so you must collect haul data from an alternate source. Be very clear in communicating your data needs to the vessel, keeping in mind that the vessel operator may not be familiar with the observer program’s haul data requirements.

Vessels may use an alternative method of logging catch information, such as a personal notebook or unofficial logbook. You are allowed access to this data while on board the vessel. However, vessels under 60ft are not required to provide you copies of their personal notes of haul data.

Regardless of what your vessel is using to document their fishing effort, you are required to obtain all basic haul information and report it on the Vessel and Observer Haul Forms. *These data are expected to be verified on a daily or haul-by-haul basis during a trip to ensure they are accurate.* How often this is done depends on the accuracy of the recorded data.

Fishing Effort Summary Form for Fixed Gear

To facilitate an easy sharing of data, you must offer the captain the “Fishing Effort Summary for Fixed Gear Vessels” form. See “Fishing Effort Summary Form for Fixed Gear” on page 7-8 for form directions and an example in Figure 7-4 on page 7-7.

Verifying Total Pots

For each pot vessel to which you are deployed, you need to develop a method to independently verify the total number of pots retrieved for as many hauls as possible. This includes both sampled and non-sampled hauls. Verifying the total number of pots is important in order to accurately assess catch per unit effort (number of fish per pot).

Gear deployment strategies and methods that different captains use to log the number of pots in a haul can be quite different. You must communicate with the captain to determine how they are delineating hauls and documenting total pots per haul. Once you understand how the captain is doing this, develop a method to verify this information independently.

If you notice any discrepancies between your verified total pots in a haul and what the captain is reporting, consult the captain to see if there has been any miscommunication. Errors are common on pot vessels, so do not assume what you verified is incorrect. Document all discrepancies and resolutions in your logbook, and notify your inseason advisor or Observer Program staff.

Methods for Verifying Total Pots

There are multiple methods that can be used to verify the total number of pots in a haul. Determine which

verification method is most applicable based on vessel activities, such as how fast they deploy or retrieve pots, the number of pots in each haul, and the time and effort you have to complete your assigned tasks aboard the vessel. It should be noted that these methods are guidelines and can be used interchangeably. Regardless of which method you use, documentation in your Daily Notes and tallies on your Deck Forms should validate how you independently verified total pots. If you determine that none of the methods described below will work for you, document the situation in your logbook and notify your inseason advisor or Observer Program staff.

Common Verification Methods for Small Hauls:

1. Count the pots as they are deployed or retrieved. You must be able to count every pot in the haul when using this method.
2. Count all pots on board before and after a haul is deployed.
3. Count all pots on board before and after a haul is retrieved.
4. Once you know the captain is recording pots correctly, you can count the total number of pots on the plotter and cross-check what is documented in the vessel logbook.

Common Verification Methods for Large Hauls:

1. Use the plotter and time together to verify the total number of pots in a haul. For example, by documenting the exact start and stop times of your samples, you determine that the vessel retrieved 15 pots per hour, and you know the boat retrieved gear for 10 hours. Using this information, you can extrapolate that 150 pots were retrieved. Cross-check your calculation with what the captain recorded in the vessel logbook or what is on the plotter.
2. Count and document all pots for an identifiable section of a haul. This can be the pots that you sampled. Cross-check your numbers with the plotter and/or captain's logbook.

Whether you use the captain's system to delineate hauls or a system of your own, talk to the captain frequently and check the vessel logbook at least twice per day, preferably after every haul.

Lost Pots and Stored Pots

Pots that are lost are not included in “Total Pots in Set” on the OHF. Remember to reference the “Pots Lost” column in the vessel logbook. “Stored pots” are pots left in the water un-baited, with the doors secured open. Stored pots should not be included in the Total Pots in Set.

Verifying Pot Type

For each pot vessel to which you are deployed, you need to independently verify what type of pot is deployed for as many hauls as possible. Determine if the vessel is fishing with rigid pots or slinky pots. See page 9-10 for examples of both slinky pots and rigid pots. If a mix of both rigid and slinky pots are used, determine what type the majority of the pots in the haul are. This pot type information will be entered for each haul on the OHF in the Gear Descriptor field. See Gear Descriptor information on page 9-8.

Verifying Fishing Method - Single Pots or Strung Pots

For each pot vessel to which you are deployed, you need to independently verify if the vessel is fishing with single pots or strung pots in as many hauls as possible. See page 9-2 for a description of single pot gear and page 9-2 for a description of strung pot gear. This information will be entered for each haul on the OHF in the Fishing Method field. See Fishing Method information on page 9-8.

VERIFYING DEPLOYMENT AND RETRIEVAL INFORMATION

Fishing duration is an important aspect used in fisheries management. Therefore, it is essential to verify the deployment and retrieval positions and times for as many hauls as possible. Time and position errors are common in pot vessel logbooks and are a major contributor to data loss during debriefing. It is important to work closely with vessel personnel to ensure the information is being recorded correctly. Document all discrepancies and resolutions in your logbook, and notify your inseason advisor or Observer Program staff for any unresolved issues.

You must verify the following information, from the vessel logbook entries or your personal observations:

Date and Time of Gear Deployment/Retrieval

Whenever possible, note the times when the crew deploys the first pot of a haul and when the last pot of a haul is retrieved. *Deployment time is when the first pot enters the water, and the retrieval time is when the last pot is brought aboard.* You will not be able to verify deployment or retrieval times for all hauls. For unverified hauls, rely on the information provided by vessel personnel in the vessel logbook. If the logbook contains erroneous times, let the officer in charge of the logbook know about the error. If incorrect data continues to be logged, consult NMFS for advice.

Position of Gear Deployment and Position of Gear Retrieval - Latitude and Longitude

The Deployment position of a haul is where the *first pot* enters the water. The Retrieval position of the haul is where the *last pot* of a haul is retrieved. The captain or a mate reads these positions from the GPS navigation system located on the bridge. Occasionally, check that the positions listed in the vessel’s logbook match that on the GPS display for when the first pot of the haul enters the water and when the last pot of the haul is retrieved. Review positions listed in the vessel’s logbook. Question any large changes in position between one haul and the next if you have not had a long run between hauls. The person responsible for the logbook may have incorrectly entered the position(s).

ESTIMATING DISCARDS

Observers must make an *independent estimate* of discards for all sampled hauls. Refer to “Estimating Discards” on page 7-8 for information about discards, as the concept is similar for longline and pot gear. Accounting for catch discarded from pot vessels may be done in one of the following ways:

1. Using visual cues, such as how many baskets of discards a sample generated, can help you to quantify what you are seeing. For example, if one of your samples is 4 pots resulting in about one basket of discards (approximately 40 kg), and that sample represents 1/9th of the haul, then you have 360 kg of estimated discards (40 kg x 9 units).
2. A simple visual estimate based on your observations may be the easiest method. For example, if you estimate that 10% of the catch was discarded, then

simply multiply the vessel estimate by 0.10 and enter that weight for discard on the OHF (Ex: 8000 kg x 0.10 = 800 kg of discards). Experience with method one will help you to make more accurate visual estimates.

POT OPENING DATA

Different pot types are used in the pot fisheries off Alaska. Information on the sizes of the entrance tunnels and escape rings a vessel is using in their pot gear is an important factor in stock assessments and inseason management of pot fisheries. *Pot opening data must be collected in all pot gear fisheries regardless of the pot type or fishing method used.*

How to measure

Measure the internal diameter of escape rings and entrance tunnel openings using the NMFS issued tape measure. These measurements should not include the ring or mesh materials. If an escape ring or tunnel entrance is not circular (e.g. oval or rectangular), the internal diameter should be taken at the widest point. Measurements should be recorded to the closest centimeter.

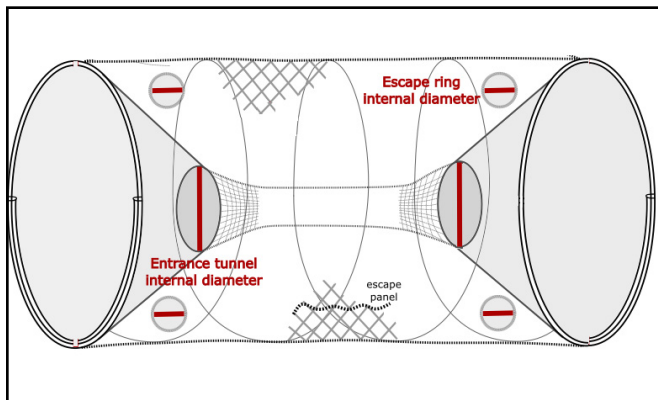

Figure 9-3: Slinky Pot Entrance Tunnel and Escape Ring Pot Opening Measurements Diagram

Collection Procedures:

1. Complete measurements once for each pot vessel that you are deployed on. Measurements should be repeated if the vessel makes changes to the gear. If you are assigned to a vessel multiple times during your deployment, ask the vessel operator if the gear has changed since you were last on board. If the gear was changed, repeat the data collection.

2. Each pot opening data collection consists of measurements from all escape rings and entrance tunnels on five individual pots.



Never climb on, or inside pots, to obtain pot opening data. If safe access to the pot openings is not available document the situation in your Daily Notes and contact your inseason advisor.

3. Your approach to measuring escape rings and tunnel entrances depends on how the vessel is storing gear, therefore, randomization is not required when selecting which pots will be used for pot opening measurement data.

4. From the predominant pot type being used by the vessel, collect opening data from 5 different pots. From each pot you are taking measurements from document the following information on the Deck Form.

- **Pot Number:** You are responsible for coming up with a numbering system that ensures each pot number is unique for each pot opening data collection within a cruise/permit.
- **Date:** Record the date you completed your last measurement for the pot opening data collection.
- **Pot Type:** Record if the pot is a rigid pot or a slinky pot.
- **Escape Ring Present:** If metal ring(s) are sewn into the pot mesh, document that escape rings are present. If metal ring(s) are not sewn into the pot mesh, document that escape rings are absent.
- **Opening Type:** For each pot opening measurement, document if the opening is an escape ring or an entrance tunnel.
- **Opening Size:** Measure the internal diameter of each of the pot's escape rings and entrance tunnels to the closest centimeter and record these measurements.



If a tunnel entrance is equipped with halibut excluders, measure the largest portion of the opening not blocked by the excluders! Include a comment in ATLAS when recording this entrance tunnel measurement in the Pot Opening Form. This comment should indicate that halibut excluders were used. See "Pot

Gear” on page 9-2 for a description of halibut excluders.

- **Opening Status:** For each opening document the status of the opening. If an escape ring or entrance tunnel has been closed off (e.g. zip-tied shut or crushed closed), record closed. If the pot opening has not been closed, record open.

An example of the raw data recording expectations for pot opening data may be found on page 9-11 and page 9-12. These data are entered directly in to the Pot Opening Data Form in ATLAS.

OFFLOAD DATA FOR POT VESSELS

The Offload Form for a catcher pot vessel delivery is filled out in the same manner as it is for a longline offload. Refer to “Offload Form Instructions” on page 7-16 of the Longline Catch chapter for Offload Form instructions.

DETERMINING DELIVERY WEIGHT

Refer to “Determining Offload Delivery Weight” on page 7-16 for instructions on determining your vessel’s delivery weight.

Partial Coverage Offload Verification

Observers deployed in the partial coverage sector must also verify that an offload occurred. If you are not staying on the vessel you need to communicate to the captain that you must be notified when the offload begins or given the offload start time so that you have the opportunity to go to the plant and verify the offload is taking place.

VESSEL HAUL FORM (VHF) FOR POT VESSELS

The Vessel Haul Form is used for recording fishing effort data for all gear types. There are very few differences between the VHF information required on a longliner and that required on a pot vessel. Below are the form items for pot vessels that have data elements differing from longline vessels.

- **Gear Type:** code for a pot or trap vessel is 6.
- **Gear Performance:** codes applicable to pot vessels are:
 - 1 - No Problem.

- 5- Miscellaneous problem in retrieving gear; document the problem in your log book daily notes.
- 6- Problem; pots were lost.
- 9 - NOT USED FOR FIXED GEAR.

Note in the comments section of the Vessel Haul Form and your Daily Notes the reasons for using gear performance codes other than code “1”.

For information on filling out the rest of the fields on the Vessel Haul Form, please refer to the longline section starting on “Completing the Vessel Haul Form” on page 7-18. For a pot vessel VHF example, see Figure 9-14 on page 9-13.

OBSERVER HAUL FORM (OHF) FOR POT VESSELS

For most of the columns on the OHF, refer to the longline section “Completing the Observer Haul Form” on page 7-21. Always start a new OHF when you start a new VHF. Include the same spacing and zeros for non-fishing days as you have entered on the VHF. Keep separate sets of forms for each vessel to which you are assigned. Below are those form items that have data elements differing from longline vessels. For a pot vessel OHF example, see Figure 9-15 on page 9-14.

- **Gear Descriptor:** Enter the code for pot gear that best describes what type of pot was used or each haul.
 - 1 - Rigid Pot Only
 - 2 - Slinky Pot Only
 - 3 - Mixed Rigid Predominant; both rigid pots and slinky pots were used and the majority of the pots in the haul were rigid pots.
 - 4 - Mixed Slinky Predominant; both slinky pots and rigid pots were used and the majority of the pots in the haul were slinky pots.
 - 5 - Other Pot Type
 - 6 - Observer Did Not Check Pot Type
- **Fishing Method:** Enter the code that best describes how the pots in the haul were deployed.
 - 1 - Single Configuration; each individual pot was deployed with a single buoy line.

- 2 - Strung Configuration; multiple pots were attached to a single groundline which was attached to a buoy line on one or both ends.
 - 3 - Mixed Single Predominant Configuration; both single pots and strung pots were deployed and the majority of the pots were single pots.
 - 4 - Mixed Strung Predominant Configuration; both strung pots and single pots were deployed and the majority of the pots were strung pots.
 - 5 - Mixed Unknown Configuration; both single pots and strung pots were deployed and it is unknown how the majority of the pots were deployed.
 - 6 - Observer Did Not Check Deployment Configuration.
- **% Monitored for Marine Mammals:** This is the percentage of the gear you monitored for the presence of marine mammals. Divide the number of pots you watched being retrieved by the total number of pots in the haul to obtain this number.
 - **Hook Coll. #, # of Segments in Set, and Bird Deterrence Code:** These fields are for longliners only. Leave these columns blank.
 - **Total Pots in Set:** Enter the total number of pots retrieved for the set (haul). Do not include lost or stored pots! Total Pots must be a whole number. There must be an entry in this field for each haul.

POT VESSEL CATCH DATA : OBSERVER HAUL FORM (OHF) FOR POT VESSELS

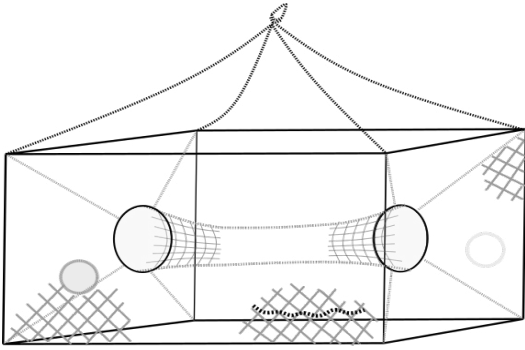

Figure 9-4: Rectangular Pot (Rigid) Diagram



Figure 9-5: Rectangular Rigid Pot (Rigid) Photo

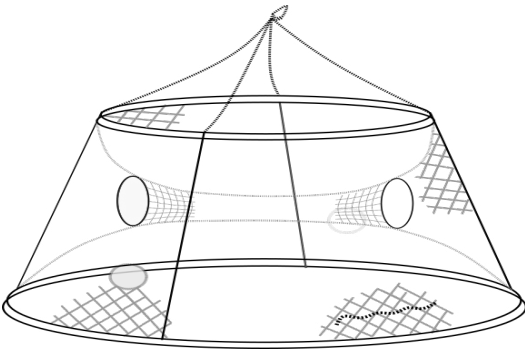

Figure 9-6: Conical Pot (Rigid) Diagram



Figure 9-7: Conical Pot (Rigid) Photo

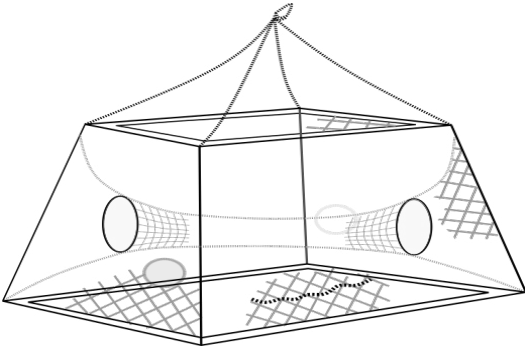

Figure 9-8: Pyramid Pot (Rigid) Diagram



Figure 9-9: Pyramid Pot (Rigid) Photo
(multiple pots stacked on deck)

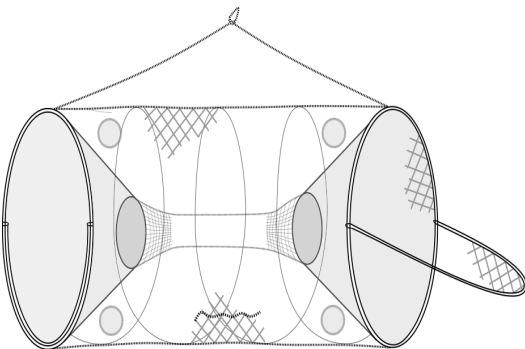

Figure 9-10 Slinky Pot Diagram



Figure 9-11 Slinky Pot Photo

DECK FORM

| | | | | |
|------------|--------|--------|----------|-------------|
| Date | Cruise | Permit | Haul No. | Offload No. |
| 10/19/2023 | 25200 | 5137 | | |

Page 1 of _____ for Vessel/Plant

Page _____ of _____ for Haul/Offload

| | | | | |
|---|--------------------------------|---|-------------------|---|
| Sample #: | Sub-Sample #: | Sample Size: | Kgs Segments pots | # of Sampled Hooks: |
| Presorted <input type="radio"/> | Combined <input type="radio"/> | Unable to Follow Design <input type="radio"/> | | No Fish in Sample <input type="radio"/> |
| Species | Sex | # | Weight | % ret. |
| ----- KEYPUNCH ----- | X | | | X |
| Length, viability, injury, specimen, tally data, measurements, bird observations, sample design, notes: | | | | |
| <p><u>Pot Openings</u> * All tunnel entrances equipped with halibut excluders. Entrance measurements taken at largest opening not blocked by excluders</p> <p>Pot 1- Rigid Entrance- 23, 23 Escape rings- 8, 8</p> <p>Pot 2- Rigid Entrance- 23, 23 Escapering- 8, 8</p> <p>Pot 3- Rigid Entrance- 23, 23 Escapering- 8, 8</p> <p>Pot 4- Rigid - Entrance- 23, 23 Escape ring- 8, 8</p> | | | | |
| | | | | Tally K/P |

| | | | | |
|---|--------------------------------|---|-------------------|---|
| Sample #: | Sub-Sample #: | Sample Size: | Kgs Segments pots | # of Sampled Hooks: |
| Presorted <input type="radio"/> | Combined <input type="radio"/> | Unable to Follow Design <input type="radio"/> | | No Fish in Sample <input type="radio"/> |
| Species | Sex | # | Weight | % ret. |
| ----- KEYPUNCH ----- | X | | | X |
| Length, viability, injury, specimen, tally data, measurements, bird observations, sample design, notes: | | | | |
| <p>Pot 5- Rigid Entrance- 23, 23 Escape ring- 8, 8</p> | | | | |
| | | | | Tally K/P |

Figure 9-12: Pot Opening Raw Data Collection Example on a Pot Vessel Using Rigid Pots

POT VESSEL CATCH DATA : OBSERVER HAUL FORM (OHF) FOR POT VESSELS

DECK FORM

| | | | | |
|----------|--------|--------|----------|-------------|
| Date | Cruise | Permit | Haul No. | Offload No. |
| 05/14/23 | 25108 | 2571 | | |

Page 1 of _____ for Vessel/Plant

Page _____ of _____ for Haul/Offload

| | | | | |
|--|--------------------------------|---|-------------------|---|
| Sample #: | Sub-Sample #: | Sample Size: | Kgs Segments pots | # of Sampled Hooks: |
| Presorted <input type="radio"/> | Combined <input type="radio"/> | Unable to Follow Design <input type="radio"/> | | No Fish in Sample <input type="radio"/> |
| Species | Sex | # | Weight | % ret. |
| ----- KEYPUNCH ----- | X | | | X |
| Length, viability, injury, specimen, tally data, measurements, bird observations, sample design, notes: | | | | |
| <p><u>Pot Openings</u></p> <p>Pot 1 - slinky Entrance - 15, 15 Escape rings - 8, 8, 8, 8</p> <p>Pot 2 - slinky Entrance - 15, 15 escape rings - 8, 8, 8, 8</p> <p>Pot 3 - slinky Entrance - 15, 15 Escape rings - 8, 8, 8, 8</p> <p>Pot 4 - slinky Entrance - 15, 15 Escape rings - closed, closed, closed, closed</p> | | | | |
| | | | | Tally K/P |

| | | | | |
|---|--------------------------------|---|-------------------|---|
| Sample #: | Sub-Sample #: | Sample Size: | Kgs Segments pots | # of Sampled Hooks: |
| Presorted <input type="radio"/> | Combined <input type="radio"/> | Unable to Follow Design <input type="radio"/> | | No Fish in Sample <input type="radio"/> |
| Species | Sex | # | Weight | % ret. |
| ----- KEYPUNCH ----- | X | | | X |
| Length, viability, injury, specimen, tally data, measurements, bird observations, sample design, notes: | | | | |
| <p>Pot 5 - slinky Entrance - 15, 15 Escape rings - 8, 8, 8, 8</p> | | | | |
| | | | | Tally K/P |

Figure 9-13: Pot Opening Raw Data Collection Example on a Pot Vessel Using Slinky Pots

POT VESSEL CATCH DATA : OBSERVER HAUL FORM (OHF) FOR POT VESSELS

| | | | | | | | | | | | | | | |
|------------------------|-----------------------|---------------------|--------------------------------------|--|--|--|--|--|--|--|--|--|---|--|
| Cruise 25200 | Permit 5137 | Year 2023 | Trip Data Form | | | | | | | | | | Page <u>1</u> of _____ for vessel _____ | |
| | | | Observer name <u>Bruce Dickinson</u> | | | | | | | | | | Resubmission (Circle All Changes) | |
| | | | Vessel name <u>Trooper</u> | | | | | | | | | | | |

| Trip No. | Crew Size | Fish in hold at start? | Port of Trip Start | Trip Start Position | | | | | | | | | Start Date | | | Port of Trip End | Trip End Position | | | | | | | | | End Date | | Time of Trip End | Did fishing occur? | Bait Used? | Time Lost at Sea (Hours) | | | | | |
|----------|-----------|------------------------|--------------------|---------------------|------|------|--------|-----------------|------|------|-------|-----|--------------------|--------------|------|------------------|-------------------|-----------------|------|------|-------|-----|---------------------|--------------------------|---------------------|-------------------------------------|---------------------------------------|------------------|--------------------|------------|--------------------------|------|--|--|--|--|
| | | | | Latitude (N) | | | E or W | Longitude (100) | | | Month | Day | Time of trip start | Latitude (N) | | | E or W | Longitude (100) | | | Month | Day | Mechanical problems | Weather related problems | Crew related issues | USCG / Enforcement related stoppage | Marine Mammal interaction/preparation | | | | Other (include notes) | | | | | |
| | | | | Deg. | Min. | Sec. | | Deg. | Min. | Sec. | | | | Deg. | Min. | | | Sec. | Deg. | Min. | | | | | | | | | | | | Sec. | | | | |
| 1 | 13 | N | 17 | 61 | 00 | 12 | W | 71 | 05 | 20 | 10 | 19 | 1009 | 8 | | | | 10 | 24 | 1241 | Y | 1 | | | | | | | | | | | | | | |
| 2 | 11 | N | 8 | | | | | | | | 10 | 24 | 1422 | 8 | | | | 10 | 26 | 0555 | Y | 1 | 2 | | | | | | | | | | | | | |

Comments:
Trip #2- Repairing engine

National Marine Fisheries Service / Fisheries Monitoring and Analysis Division Page _____ of _____ for transmission Rev. 19

| | | | | | | | | | | | | | | |
|------------------------|-----------------------|---------------------|--------------------------------------|--|--|--|--|--|--|--|--|--|------------------------|--|
| Cruise 25200 | Permit 5137 | Year 2023 | Vessel Haul Form | | | | | | | | | | Page <u>1</u> of _____ | |
| | | | Observer Name <u>Bruce Dickinson</u> | | | | | | | | | | | |
| | | | Vessel Name <u>Trooper</u> | | | | | | | | | | | |

| Trip No. | Haul No. | IFG? Y/N | CDQ No. | Gear type | Vessel Type | Gear Performance | Location Code | Pur. Code | Deployment Information | | | | | | | | | | Retrieval Information | | | | | | | | | | | | |
|----------|----------|----------|---------|-----------|-------------|------------------|---------------|-----------|------------------------|-----|------|--------------|------|------|--------|-----------|------|------|-----------------------|--------------------|--------|-----|-----|------|--------------|------|------|--------|-----------|------|------|
| | | | | | | | | | Mo. | Day | Time | Latitude (N) | | | E or W | Longitude | | | Average Bottom Depth | Average Gear Depth | M or F | Mo. | Day | Time | Latitude (N) | | | E or W | Longitude | | |
| | | | | | | | | | | | | Deg. | Min. | Sec. | | Deg. | Min. | Sec. | | | | | | | Deg. | Min. | Sec. | | Deg. | Min. | Sec. |
| 1 | 1 | N | | 6 | 3 | 1 | R | CA | 10 | 19 | 2230 | 61 | 10 | 55 | W | 71 | 20 | 35 | 27 | | F | 10 | 21 | 1707 | 61 | 15 | 01 | W | 71 | 33 | 42 |
| 1 | 2 | N | | 6 | 3 | 6 | R | CA | 10 | 19 | 1732 | 61 | 12 | 30 | W | 71 | 31 | 40 | 27 | | F | 10 | 22 | 0003 | 61 | 15 | 59 | W | 71 | 25 | 49 |
| 1 | 3 | N | | 6 | 3 | 1 | R | CA | 10 | 20 | 0056 | 61 | 12 | 49 | W | 71 | 31 | 10 | 25 | | F | 10 | 22 | 1304 | 61 | 15 | 06 | W | 71 | 33 | 02 |
| 1 | 4 | N | | 6 | 3 | 1 | R | CA | 10 | 20 | 1339 | 61 | 13 | 11 | W | 71 | 24 | 56 | 24 | | F | 10 | 22 | 2007 | 61 | 15 | 49 | W | 71 | 33 | 48 |
| 1 | 5 | N | | 6 | 3 | 1 | R | CA | 10 | 22 | 1906 | 61 | 14 | 55 | W | 71 | 24 | 30 | 26 | | F | 10 | 23 | 0059 | 61 | 13 | 10 | W | 71 | 24 | 58 |
| 1 | 6 | N | | 6 | 3 | 6 | R | CA | 10 | 23 | 0257 | 61 | 13 | 42 | W | 71 | 24 | 16 | 30 | | F | 10 | 23 | 1400 | 61 | 14 | 12 | W | 71 | 25 | 55 |
| 1 | 7 | N | | 6 | 3 | 1 | R | CA | 10 | 23 | 1432 | 61 | 15 | 22 | W | 71 | 27 | 37 | 32 | | F | 10 | 23 | 1602 | 61 | 15 | 01 | W | 71 | 34 | 01 |
| 1 | 8 | N | | 6 | 3 | 1 | R | CA | 10 | 23 | 1730 | 61 | 13 | 47 | W | 71 | 24 | 14 | 27 | | F | 10 | 23 | 2201 | 61 | 15 | 02 | W | 71 | 27 | 55 |
| 1 | 9 | N | | 6 | 3 | 1 | R | CA | 10 | 23 | 2335 | 61 | 12 | 46 | W | 71 | 31 | 19 | 25 | | F | 10 | 24 | 0723 | 61 | 15 | 51 | W | 71 | 27 | 15 |
| 2 | 10 | N | | 6 | 3 | 1 | R | CA | 10 | 24 | 1526 | 61 | 13 | 59 | W | 71 | 24 | 51 | 26 | | F | 10 | 25 | 0904 | 61 | 15 | 50 | W | 71 | 33 | 41 |
| 2 | 11 | N | | 6 | 3 | 1 | R | CA | 10 | 25 | 1011 | 61 | 13 | 05 | W | 71 | 24 | 06 | 20 | | F | 10 | 25 | 1811 | 61 | 14 | 35 | W | 71 | 33 | 57 |
| 2 | 12 | N | | 6 | 3 | 1 | R | CA | 10 | 25 | 1503 | 61 | 13 | 17 | W | 71 | 40 | 36 | 28 | | F | 10 | 25 | 2309 | 61 | 16 | 29 | W | 71 | 36 | 12 |

Comments:

National Marine Fisheries Service / Fisheries Monitoring and Analysis Division Ver. 2024

Figure 9-14: Examples of Trip Form and VHF a Pot Vessel

POT VESSEL CATCH DATA : OBSERVER HAUL FORM (OHF) FOR POT VESSELS

| | | | | | | | | | |
|--------------------------------------|-----------------------|---------------------|----------------------------|--|--|--|--|-------------------------------|-------------|
| Cruise 25200 | Permit 5137 | Year 2023 | Observer Haul Form | | | | | Page <u>1</u> of <u> </u> | |
| Observer Name <u>Bruce Dickinson</u> | | | Vessel Name <u>Trooper</u> | | | | | Full Name of Catcher Boat | ADF&G # |

| Haul No. | Haul Sampled By (Cruise No.) | RST On Haul? (Y=On, N=Off, X=NA) | RST On Break? (Y=On Break, N=No Break) | Sample Design | Sample Unit Type | % Monitored for Marine Mammals | Gear descriptor | Fishing Method | Trawl Vessels | | | | Longline and Pot Vessels | | | | | | |
|----------|------------------------------|----------------------------------|--|---------------|------------------|--------------------------------|-----------------|----------------|-----------------------------------|-------------------------------|-------------------------------|-----------|------------------------------|---------------------------------------|-------------|--------------------------------------|---|------------------------|---------------------|
| | | | | | | | | | Vessels Total Catch Estimate (mt) | Estimated Discard Weight (kg) | Observers Catch Estimate (kg) | B, C or W | Density (kg/m ³) | Volumetric Estimate (m ³) | Hook Coll # | # of Segments in Set (Longline Only) | Total Pots (or Hooks) in Set (required for pot vessel only) | Flow Scale Weight (MT) | Rat. Clearance Code |
| 1 | 25200 | X | N | 7 | 1 | 33 | 1 | 1 | 10.00 | 5000 | | | . | . | | | . | 106 | . |
| 2 | 25200 | X | N | 7 | 1 | 33 | 1 | 1 | 9.00 | 2000 | | | . | . | | | . | 105 | . |
| 3 | 0 | X | Y | 7 | 1 | 0 | 6 | 6 | 11.00 | | | | | . | . | | | 105 | . |
| 4 | 25200 | X | N | 7 | 1 | 33 | 1 | 1 | 0.50 | 2000 | | | . | . | | | . | 105 | . |
| 5 | 25200 | X | N | 7 | 1 | 43 | 1 | 1 | 10.00 | 7000 | | | . | . | | | . | 01 | . |
| 6 | 25200 | X | N | 7 | 1 | 37 | 1 | 1 | 7.00 | 3000 | | | . | . | | | . | 75 | . |
| 7 | 0 | X | Y | 7 | 1 | 0 | 6 | 6 | 2.00 | | | | | . | . | | | 25 | . |
| 8 | 25200 | X | N | 7 | 1 | 34 | 1 | 1 | 9.00 | 2000 | | | . | . | | | . | 04 | . |
| 9 | 25200 | X | N | 7 | 1 | 33 | 1 | 1 | 11.00 | 1000 | | | . | . | | | . | 104 | . |
| 10 | 25200 | X | N | 7 | 1 | 33 | 1 | 1 | 4.00 | 1500 | | | . | . | | | . | 104 | . |
| 11 | 25200 | X | N | 7 | 1 | 33 | 1 | 1 | 3.50 | 500 | | | . | . | | | . | 104 | . |
| 12 | 25200 | X | N | 7 | 1 | 48 | 1 | 1 | 1.50 | 1500 | | | . | . | | | . | 49 | . |

Comments:

National Marine Fisheries Service/Fisheries Monitoring and Analysis Division Ver. 2024

| | | | | | | | | | | |
|--------------------------------------|-----------------------|---------------------|-----------------------------------|--|--|--|--|------------------------------|------------------------|-------------------|
| Cruise 25200 | Permit 5137 | Year 2023 | Plant/Vessel Offload Form | | | | | Page <u>1</u> of <u> </u> | | |
| Processor Name <u>St. Johns Sfds</u> | | | Processor Permit No. <u>00555</u> | | | | | Catcher Boat Name | Catcher Boat ADF&G No. | Vessel Permit No. |
| Observer Name <u>Bruce Dickinson</u> | | | Vessel/Plant Name <u>Trooper</u> | | | | | | | |

| Offload Trip(s) | Offload No. | Completion Date | | Plants only | | Total Delivered | Kg or Lb | Total Pollock Weight <small>BSAI Pollock Only</small> | Were All Groundfish Weighed? (Y/N) | ADF&G No. of Delivering Vessel | Receiving Processor Permit No. <small>Vessels Only</small> | Was Catch Sorted? (Y/N) | Tender Offload? (Y/N) | Landing Report ID No. | Plants only | |
|-----------------|-------------|-----------------|-----|-------------|-----------|-----------------|----------|--|------------------------------------|--------------------------------|---|-------------------------|-----------------------|-----------------------|-----------------------------|---------|
| | | Month | Day | Gear Type | NMFS Area | | | | | | | | | | Elanding Management Program | CDQ No. |
| 1 | 1 | 10 | 24 | | | 167549 | Lb | | | 00555 | Y | N | 200645 | | | |
| 2 | 2 | 10 | 26 | | | 19841 | Lb | | | 00555 | Y | N | 200646 | | | |

Notes:

National Marine Fisheries Service/Fisheries Monitoring and Analysis Division Page _____ of _____ for Transmission Ver. 2014

Figure 9-15: Examples of OHF and Vessel Offload Data From a Pot Vessel

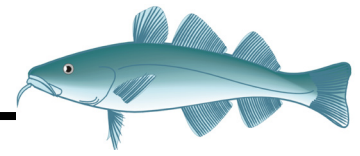

POT VESSEL COMPOSITION SAMPLING

Table of Contents

| | |
|---|-------|
| Priorities | 10-1 |
| Composition Sampling Guidelines | 10-2 |
| Selecting Hauls to Sample | 10-2 |
| Preferred Sampling Method | 10-3 |
| Pot Vessel Species Composition Samples and Subsamples | 10-3 |
| Number of Samples per Sampled Haul | 10-3 |
| Sample Size Considerations | 10-3 |
| When to Sample for Species Composition | 10-4 |
| Sample Design Development | 10-4 |
| Random Sampling on Pot Vessels | 10-4 |
| Sampling Rules | 10-5 |
| Gear Based Systematic Sampling Design | 10-6 |
| Gear Based Simple Random Sampling Design | 10-6 |
| Verifying Sampled Pots | 10-8 |
| Sampling on Pot Vessels | 10-8 |
| Species Composition Tally and Weights | 10-8 |
| Minimizing Sample Bias | 10-9 |
| Collecting Weights for Non-Predominant Catch | 10-9 |
| Collecting Weights for Predominant Catch | 10-10 |
| When You Cannot Count All the Crab in a Pot | 10-10 |
| Dealing with Whole Crab Versus Crab Pieces | 10-10 |
| Corals | 10-11 |
| Tips for Sampling on a Pot Vessel | 10-11 |
| Subsamples on Pot Vessels | 10-11 |
| Sampling on Vessels Fishing With Strung Pot Gear | 10-12 |
| Combined Samples | 10-12 |
| When There Are No Fish Encountered During the Sample | 10-12 |
| Estimating Percent Retained | 10-12 |
| Halibut Viabilities on Pot Vessels | 10-12 |
| Fish Measurements and Biological Data on Pot Vessels | 10-12 |
| Live Deliveries | 10-13 |
| Deck Form Instructions. | 10-13 |

PRIORITIES

- Your safety!
- Collect data and specimens from marine mammal and endangered sea bird mortalities.
- Rehabilitate ESA-listed seabird species.
- Sample for species composition.
- Send data to the Observer Program as directed (see “Sending Data” on page 2-39).
- Document any compliance concerns.
- Measure and assess viability of Pacific Halibut.
- Measure and sex other prohibited species.
- Collect biological data from the appropriate species.
- Collect sexed lengths from the appropriate predominant species.
- Record calculations and daily log book notes.
- Complete research projects.

INTRODUCTION

Species composition sampling is high on the Observer Program’s priority list, and more time is spent on this task than any other. Species composition sampling is the collection of catch samples from a selected haul.

Fisheries managers base their assessment of catch rate on the results of your species composition samples. The data you collect are used to monitor allowable harvest and is used by scientists for population analysis and stock assessment.

Keep in mind during your composition sampling efforts that complete, accurate, and verified haul data is required for management. Accurate haul data is a higher priority than composition sampling.

COMPOSITION SAMPLING GUIDELINES

One of the first things you should do when you arrive on a vessel is to become familiar with your boat and its fishing operations. Inspect your sampling station and any other areas where you might be working. This will help you determine how you will sample on this boat. Refer to “Becoming Familiar with Your Vessel” on page 2-4 and for guidelines specific to pot vessels and see “Pot Vessel” on page 2-6. When deciding how to sample on your vessel, consider the following:

- Safety on deck.
- Where to collect and contain your weight sample.
- What sampling biases could occur in your collection and how to minimize them.
- How to collect your sample.
- How many samples you will be able to collect.
- What sample sizes you will be able to collect.
- How you will process your sample.
- Do you need to use the Random Sampling Table (RST) or Random Break Table (RBT).

Equipment: You will need a couple of thumb counters, a clipboard, pencil, and Deck Forms. It is important to check the functionality of your thumb counters and to oil them on a regular basis. This will ensure that your thumb counters work properly when you are tallying your sample.

Sample Station

The sample station is the location where you will weigh and measure catch. Many CP vessels have a sample station already setup for observer use and some have motion compensated platform scales (see page 2-29). However,

the majority of pot vessels do not have established work stations for the observer. On vessels that do not have established stations, select a location that is out of the way of wave action and crew traffic, and that has enough room to store one or two baskets of fish. On some vessels, you won't have much choice where you set up a sampling station and you will have to work with the area available to you. Explain your needs to the crew and work with them as much as possible. If storage space is an issue, you can always ask the vessel if they have an extra tote for you to use. If you are on a catcher vessel, you can also ask the plant for one or go to the field office and check out more observer baskets.

Sampling on Smaller Vessels

You may have reduced storage and work area on pot vessels less than 60 feet and may need to modify your sampling efforts accordingly using the priorities outlined in the Observer Sampling Manual. Small vessel decks are especially challenging due to smaller work space, lower railings, and close work proximity to moving pots. Always make sure you have a safe work area away from moving pots for your species composition and biological sample collection.

Sample Design Documentation in the Logbook

In your Daily Notes, discuss the random sample design you intend to use. Your sampling design will be put to the test once you start sampling, and you may find that you need to make some changes to it.

When you have settled on a random sample design(s), fill out a Sample Design Detail Form in your logbook. On this form, describe your sampling design in detail. Day to day minor adjustments to the random sample design can be documented in the Daily Notes section of your log book.

First Haul Safety

Observers should be especially careful on deck until they are familiar with the way catch and gear are handled on the vessel. Every vessel operates differently. Watch the retrieval of the first few pots of the haul you are sampling to familiarize yourself with deck procedures.

SELECTING HAULS TO SAMPLE

On some vessels, you will be able to sample every haul. This is typically the case for observers on pot vessels targeting Sablefish. In general, observers with a

familiarity with the vessel type and fishery are expected to sample all hauls when less than three per day are landed or if the boat only fishes for part of the day. When extenuating circumstances prevent this, document the circumstances in your logbook.

If you cannot collect species composition data from all hauls you must randomly select which hauls to sample using the appropriate Random Sample Table (RST) and/or Random Break table (RBT). Refer to “How to Use the RST” on page 2-19 for instructions on using the RST and “How to Use the RBT” on page 2-19 for instructions on using the RBT. *Please note that using the RST and RBT together is rarely done on pot vessels.* Consult your inseason advisor or NMFS staff (see “Contact Addresses and Numbers” on page A-61) if you frequently use them together as the sampling effort for that vessel will be low.

Preferred Sampling Method

There are several sampling methods available to you for collecting samples. These are covered in “Sample Design Development” on page 10-4. As discussed in the section “Introduction to Sampling Theory” on page 2-21, the preferred method for all vessel types is to take *systematic random samples made up of approximately equal sized units.*

To achieve systematic random sampling on pot vessels, the haul is divided into sampling units of equal size. Units to sample are chosen using a systematic random method. Pot fishing is unique in that individual pots can be deployed over a given area, in clumps or lines. Spacing samples throughout a haul accounts for any fish stratification associated with topography changes over this area.

Pot Vessel Species Composition Samples and Subsamples

Pot gear species composition sampling is similar to longline composition sampling in that the sample consists of a total count (tally) of all organisms encountered, along with a collection of organisms that are counted and weighed. During a tally period, everything that comes up inside a pot during the randomly chosen sampling unit is counted, including those species that are not retained or fall out of the pot onto the deck. The tally period always occurs as gear is being retrieved. Tallying fish in the pots is only a part of the species composition sampling process.

To supply resource managers with the essential information they need, you also collect weight information for the species tallied. During the tally period, predominant and non-predominant tallied fish are collected by the observer from the sorting bin or table, with crew assistance. The task of weighing them can be accomplished between pots within the sample unit, while the gear is still being retrieved, and/or at the end of the sampling unit. Information from a single tally period, and any fish you collect for weights during that tally period, are recorded together as a discrete sample.

On a pot vessel, the observer has access to the catch while sampling and the ability to collect predominant and non-predominant species to weigh during the tally period, therefore subsamples are rarely needed on a Pot vessel. However, subsamples are permitted under certain circumstances. See “Subsamples on Pot Vessels” on page 10-11 for pot gear subsample guidelines.

Number of Samples per Sampled Haul

You should take as many individual samples within a haul as feasibly possible. Multiple samples, taken systematically throughout the haul, address potential stratification effects. *At least three discrete composition samples are required for every sampled haul to allow data users to assess sample variance.*

There may be fisheries and vessel types where it is not possible to collect multiple species composition samples within a sampled haul. In those instances, you must document the circumstances in your logbook Daily Notes pages.

Sample Size Considerations

When deciding the size of your samples, consider your general health, the size of the haul, and the species diversity. Reduce the size of your samples if you are not feeling well, have not had enough sleep, or if species diversity has been high.

Samples taken within a haul should be of equal size. This is easy to achieve on pot vessels, because the crew is working with discrete units of gear (a pot). The total number of pots you are able to sample depends on vessel specific factors, but most observers find they can sample at least 1/3 of a haul and still have time to complete their other sampling duties.

When to Sample for Species Composition

In the pot vessel fleet, there are vast differences in the amount of gear each vessel fishes and how quickly each vessel retrieves and deploys gear. Many catcher vessels retrieve gear around the clock, taking breaks at variable times throughout the day for short naps, and usually late at night for 5-6 hours of sleep. Vessels may spend days prospecting or pulling a few short hauls before they begin their normal hauling practices. Even “normal” hauling practices have no predictable schedule and long days of 18-20 hours are not uncommon. Catcher processors, with larger crew sizes, may set and retrieve pots around the clock. All of these factors will affect your ability to sample for species composition on these vessels. Develop sampling strategies to collect systematic random samples from as many hauls as possible while keeping in mind your health and safety as well as other observer duties.

A captain may utilize one of two strategies in deploying pots; they may set one long haul of pots or they may set several smaller groupings of pots. How you sample will be determined by the captain’s method of setting gear.

- When the vessel sets several short hauls of pots use the appropriate random sample table (RST) to determine which hauls to sample or use the random break table (RBT). Use a systematic random sampling design to sample the pots retrieved from each haul. In general, observers are able to collect 3 samples totaling 1/3 of each haul.
- When hauls have less than 20 pots, observers are generally able to sample every pot in the selected haul.
- If the captain sets one or two long hauls of gear per day, sample every haul. As with shorter hauls of gear, observers are usually able to collect systematic random samples from at least 33% (1/3) of the pots retrieved from each haul.

Use the RBT if needed. See “How to Use the RBT” on page 2-19.

Sample Design Development

You may need to reduce your sampling effort for the first few hauls (fewer and/or smaller samples) to become familiar with the catch handling process, deck procedures, and will be able to decide on a sampling design that is right for that vessel and fishery. Document your methods and the reasons for the reduced sampling

effort in your Daily Notes. If you are unable to sample a haul for any reason, you must document the circumstances in your logbook.



Be sure to discuss safe deck practices, haulback procedures, and potential sampling needs with the vessel before fishing begins!

You may alter your design as you gain experience, become aware of biases, the species composition changes, or the target fishery changes. Document all changes in the Sample Design Detail section of your logbook and explain why they were made. If you have problems designing or implementing a sampling system, contact your inseason advisor or other NMFS staff member as soon as possible.

While sampling all of the pots in a haul is preferred over using a random sampling design, this would require you to count everything in every pot of a haul, weighing all bycatch if possible. Sampling all pots may be possible in some situations, but when it is not, you must use a random sampling design to determine which pots to sample.

Remember, if you abort or alter a sampling design during the sampling of a haul, document the circumstances in the Daily Notes section of your logbook.

RANDOM SAMPLING ON POT VESSELS

There are many similarities between sampling designs and sampling concepts on pot vessels and those on longliners. This chapter will often refer you to “LONGLINE COMPOSITION SAMPLING” on page 8-1.

Three types of random sample designs can be used on pot vessels:

1. simple random,
2. systematic random.
3. census

A systematic random sampling design is most commonly used on a pot vessel. Simple random sampling designs are sometimes used when hauls consist of a small number of pots and a census sample is not possible. You can alternate designs between sampled hauls to adjust for different situations.

Sampling units on a pot vessel will always be units of gear (one or several pots can comprise a sample unit).



Do not use a random sample design that is not listed unless you contact NMFS first!

Sampling Rules

Follow these rules when determining your sampling design:

1. **Number of samples trumps quantity of haul sampled:** If there is a possibility that your sample design will result in the selection of less than three samples reducing the unit size used in the sample frame. By reducing the unit size in the sample frame, you are ensuring that at least three samples can be selected. Smaller sample units may mean that you end up taking four samples for a haul instead of three depending on your randomly selected starting sampling unit. Always reselect a starting unit if you have to adjust your design to accommodate three samples taken systematically (see Figure 8-2 on page 8-7).
2. **Sampling units should be equal in size:** Size discrepancy between all sampling units should be minimized. If the total number of pots is not evenly divisible by the number of pots comprising a sample unit, there will be a unit at the end of your frame that is smaller than all other units. This is called a hanging unit. *It is critical that units be equal or as close to equal as possible, so a rule was developed to deal with this specific case.* You must determine if including the hanging unit with the previous unit of the frame would cause less of a disruption to unit size than leaving it as a discrete unit. For example, if the hanging unit is comprised of 1 pot and the previous unit comprised of 3, sample unit size will be more consistent if the last two units are combined into a unit with 4 pots. Refer to the illustration in Figure 8-1 on page 8-6 for an example of how to reduce size discrepancy in hanging units.
3. **Open Ended Population:** If your sample design is based on an estimate of pots, treat it as an open-ended population. Sample systematically until the hauling is complete. This estimate will come from communication with the captain and often is based on how many pots the captain thinks will be pulled over a certain amount of time.

Gear Based Sample Frames on Pot Vessels

When creating a sample frame on a pot boat, sampling units must be comprised of individual pots. A unit can be one or several pots, so long as they are equal.

To sample from a gear based frame, determine the number of pots in a set and decide how much of the haul you need to sample. Take into account how long you can stand on deck tallying fish from the sample pots, how much time you have to weigh predominant and bycatch species, and how much can be stored in the fish collection area when deciding on your unit size. For example, in colder months, or where space is limited, you may want to have fewer pots in your sample unit. On vessels with ample space, you may be able to have larger tally sample units (i.e. more pots per unit).

To create pot units:

1. Multiply the total number of pots in a haul by the fraction of the haul that you intend to sample (typically observers are able to sample at least 1/3 of a haul). This will give you the total number of pots you need to sample to meet your total sampling goal for the haul. For example, if a haul is 26 pots and you want to sample 1/3, you would need to sample 8.6 pots. You must sample whole pots, so you round this value to 9.
2. Take the total number of pots you need to sample and divide this by the total number of discrete samples you want to collect for the haul. If you had to sample 9 pots and wanted to do this over 3 samples, the size of the sampling units would be 3 pots.
3. Divide the total number of pots in the haul by the number of pots in a sample unit. This gives you the total number of sampling units in the haul. If the haul is 26 pots then divide 26 pots by 3 (pots per unit). The number of units on the haul is 8.6, or 8 units of 3 pots each and 1 hanging unit with 2 pots, for a total of 9 sampling units in your frame.

Sampling Designs on Pot Vessels

Using a gear based design requires you to identify when selected pots are pulled. This will be accomplished by working closely with the captain and crew. You may be able to track this information using the plotter, or for smaller hauls, actually counting pots retrieved.

Gear Based Systematic Sampling Design

Systematic sampling is always the preferred method on pot vessels. Follow these steps:

1. Consecutively number the units in the sample frame. Once the sample units are numbered, you can complete your sampling design by randomly selecting your sampling units using a simple random or a systematic design. Document the random selection method in your log book.
2. Systematic sampling requires that you sample throughout the entire haul at equal intervals from a random start point. To determine the starting sample unit for the haul, refer to the sampling fraction you chose. The sampling fraction represents the sampling interval i for the haul. For every i , you must tally one full sampling unit. If i is 3 (1/3 of the haul), randomly choose a number between 1 and 3. This random number represents the first unit you will sample from your frame. For example, if i is 3, you would randomly select a number between 1-3. If the random number chosen is 2, you would begin your systematic sampling at unit 2.
3. From the random start point, sample at interval i . For example, if the random start unit is 2, and the denominator of your sampling fraction is 3, sample every 3 units from the random start unit: 2, 5, 8 etc.

Once you have a sample design for the haul, determine if there is a chance you will get only two samples for the haul. To do this, map out the sampling sequence when you choose the last number in interval i as your start point. If this sampling sequence gives you only two samples for the haul, reduce your sampling unit size by one or more segments if possible, recalculate the number of units in the haul and select new sample units. For an example see Figure 8-1 on page 8-6.

Selecting the Start Sample Unit

Pot vessel sample units are always gear based. When sampling pot gear you will need to count pots during retrieval in order to know when to collect your samples. For smaller hauls (~30 pots) you may be able to stay out on deck and count every pot to work through your design. On large hauls there may be a couple of hours between samples and you are not expected to stay on deck the entire time to count the pots until your next

sample unit. Use the estimated time to retrieve a pot to work through your design (see Example 10-1).

For example, you are sampling a 90 pot haul and have 9 sampling units of ten pots each. If it takes approximately 3 minutes to retrieve a pot then one sample unit will take approximately 30 minutes. You randomly select 3 as your starting unit (pots 21-30). You will need to know when pot #21 (the start of unit 3) comes aboard. The 20 pots in units 1 and 2 will take approximately 60 minutes to haul. Keep in mind you need to sample starting on pot 21, not at minute 60, so you must pay attention to haul speed and be ready to sample if pot 21 is coming up earlier than the 60 minutes. Once sample 1 is complete, sample 2 will be collected approximately 60 minutes later.

Example 10-1: Systematic Sampling Using Time to Approximate Sample Collection

Closely monitor the retrieval speed and time and communicate with the wheelhouse in order to start sampling as closely to the correct pot as possible. *Because time is used to determine approximately when to collect your sample, you may at any time adjust the time per pot as the retrieval speed changes.* If you miss your pre-selected sample start, document this and continue to sample your entire sample unit. You must always sample the entire predetermined unit, even if you do not start your sample at the desired pot.

It is recognized that time and space constraints on small vessels will affect the amount of work that can be completed during a single haul. As a result you may have to reduce sample effort to obtain other data such as average weight collections of the predominant species and bycatch, and other biological data. If you are unable to accomplish all of your duties reliably, contact NMFS staff for assistance. It is important to document your sampling decisions in your Daily Notes. Refer to the priority lists on page 2-2 for guidance.

Gear Based Simple Random Sampling Design

A gear based simple random design should be used when it is not possible to collect multiple samples. Collecting a single sample may be necessary if the haul is short and/or time and space are limiting factors. Follow these steps to sample using a simple random design:

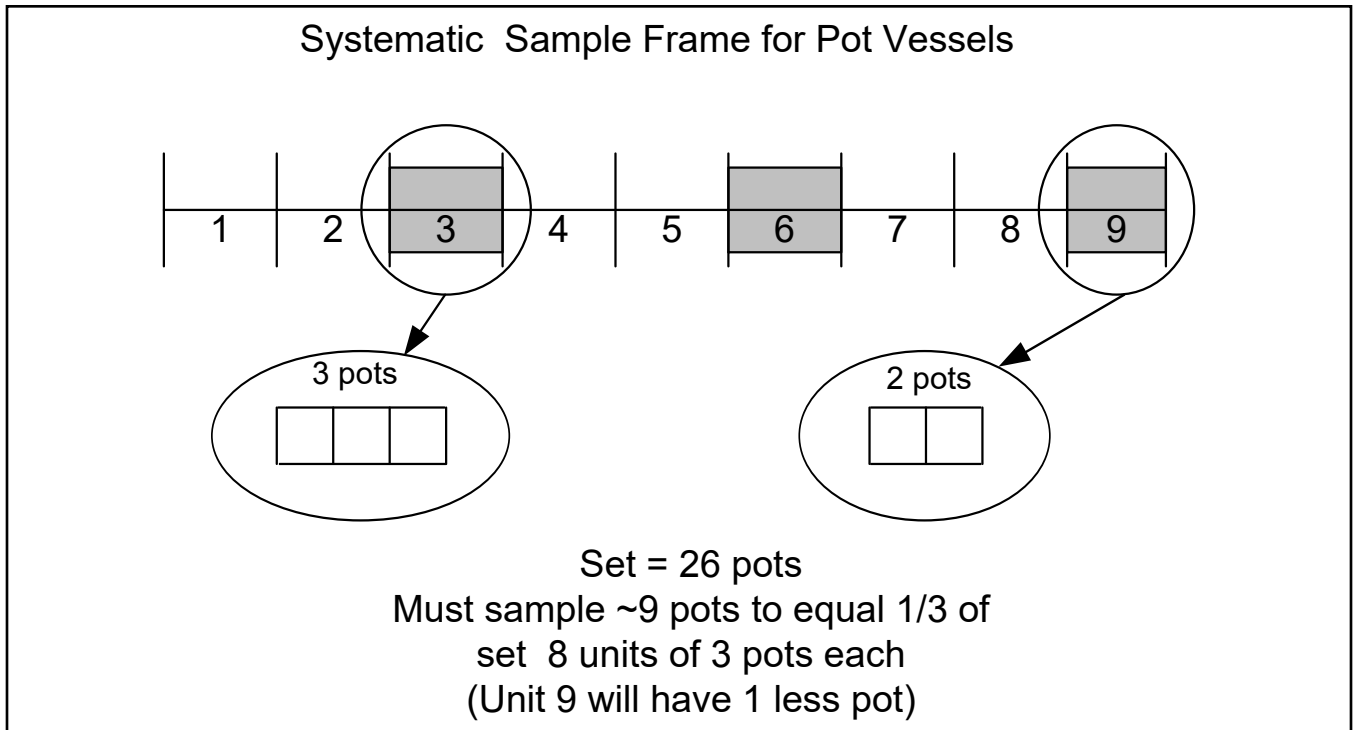

Figure 10-1: Size discrepancy with hanging units

1. Multiply the total number of pots by the desired sampling fraction to determine how many pots you need to sample. Since you will only be collecting one sample, this number is your sample unit size.
2. Determine number of units in the haul by dividing the total # of pots in the haul by the unit size.
3. List your sample units and number them.
4. Randomly select one sampling unit.

For example: A 30 pot haul and you will sample 1/3, so

- $30/3 = 10$ pots. Each group of 10 pots represents a sample unit.
- $30/10 = 3$ sample units. Randomly select a unit and sample it.

If the number of pots in the haul is not equally divisible, the last sampling unit of the frame will not be the same size as all other units in that frame. Refer to Figure 8-1 on page 8-6 and “Sampling Rules” on page 8-5 of the longline chapter for more details on how to deal with these smaller units.

Example of simple random sampling for a gear based frame: There are 20 pots in the haul. The observer is seasick but feels well enough to collect one sample and

wants to sample 1/4 of the pots. The pots are divided up into 4 units of 5 pots each. The observer uses the RNT to choose a number between 1-4 (the number of units in the haul). The observer chooses unit 3 so pots 11-15 are sampled for species composition. An example of simple random sampling from a gear based frame is illustrated in Figure 8-3 on page 8-9 of the Longline Chapter. When referring to this figure think of the units as groups of pots, rather than segments.



Systematic is always the preferred sampling method. If you have a sampling situation that requires a simple random design be sure to document this thoroughly in your Daily Notes.

ADDRESSING CHALLENGING SAMPLING SITUATIONS

On rare occasions you may not be able to sample the entire sample unit or follow your intended sample design. If the original sample unit or design for the haul cannot be followed, document what happened in your Daily Notes. Consider changing your design to one that you will be able to sample consistently if you are often having problems meeting your sample design. On the Observer

Haul Form, record the sample design code and sample unit type that best describes the method you used.

VERIFYING SAMPLED POTS

Verifying the number of pots in your sample is an important part of your independent gear verification. You must be able to track and count sampled pots on your Deck Form while collecting your species composition data. The deck is a busy place, and it is very easy to lose count of how many pots have been pulled unless you pay close attention. There are two ways you may track the pots on the Deck Form:

- Record each pot's tally of the predominant species as a total pot by pot on your Deck Form. Each total tally represents a pot and by counting the tallies you will know how many pots were pulled. Remember to record pots with no catch as they count as part of your sample. See "Example of Raw Data From a Pot Vessel" on page 10-16.
- If you are tallying all of the predominant species using a thumb counter you must clearly label a pot count on the Deck Form and make a tally mark for each pot retrieved. Remember to record pots with no catch as they count as part of your sample (see Figure 10-3 on page 10-16).

Always indicate the exact start and stop times for your sample collection. This will help you to verify gear if you are using a time based method. See "Verifying Total Pots" on page 9-5 for common methods used to verify pots in a haul.

SAMPLING ON POT VESSELS

Collection of species composition samples depends on the amount of gear retrieved, the speed of gear retrieval, and the amount of fish that is being caught.

Species Composition Tally and Weights

The species composition sample is the accurate count/tally of all organisms caught in the sampled pots. Organisms on the outside of the pot should not be taken into consideration. Weights are collected to provide an average weight to apply to your tallies.

All species in each pot you sample must be identified and tallied. For each sample, use the blank spaces provided on the Deck Form to record your tally data for the

predominant and non-predominant species (see page 10-16 for examples of species composition data collected on a pot vessel). Be aware of fish that may fall onto the deck when the pot is dumped. These must be included in your tally.

As with species identification rules on a longliner, the following species must be in hand to ID to species: Arrowtooth and Kamchatka Flounder; Northern and Southern Rock Sole; Shortraker and Roughey Rockfish; Bairdi and Opilio Tanner crabs; Red, Blue and Brown King crab; *Myoxocephalus* species; Irish lords; and the *Bathyraja* skates See "Species Identification Rules" on page 8-12 of the Longline Composition section for more details.



Figure 10-2: All Organisms in a Pot Must Be Talled

When there is little catch, all organisms from each sampled pot may be sorted, counted, and weighed. Most often this method is not possible with the predominant species, but is possible with the non-predominant species.

When counting *and* weighing everything in a pot follow these guidelines:

1. Tally all the predominant species in your sample.
2. Tally all of the non-predominant species in your sample.
3. Tally everything prior to, or during, the collection of fish from each pot in your sample. Tallying everything

on a pot by pot basis within a sample will allow you to retain your samples in the event fish in your samples are lost due to weather or crew activity. The lost fish will be accounted for and the catch per unit effort will remain accurate.

4. Collect, count, and weigh as many individuals of the predominant species from your sample that you can. You should be able to count and weigh at least 60 individuals over the course of the entire haul.
5. Collect, count, and weigh as many individuals of the non-predominant species from your sample that you can. You should be able to count and weigh at least 50 individuals of each bycatch species throughout the entire haul.

How you collect weights for predominant and non-predominant species depends on the configuration of the vessel, how the crew processes the catch after dumping it from the pot, and how much is caught in each pot.

Depending on the number of individuals, you may be able to collect all non-predominant species in a separate tote or in your observer baskets and weigh them all. If you are unable to do this, use a random method to collect individuals of these non-predominant species to obtain a weight.

Discrepancies Between Tally and Weight Samples

Remember that your tally is an accurate count of all catch in your sample unit's pots. Occasionally you may find more individuals of a species collected in your baskets than the number of that species tallied in your sample. If this happens, record the tally with a weight of zero in the sample. You must then record the number and weight of the species that were collected as a subsample.

Sampling High Bycatch Scenarios

If bycatch (other than crab) are too numerous to count and you do not feel you can tally everything during your collection on a pot-by-pot basis, do the following:

- Reduce the total number of pots in your selected sample unit so that you can tally everything during your collection. You may do this and still maintain sampling 1/3 of the haul.
- Contact your inseason adviser or Observer Program staff for guidance when bycatch are too numerous to count on a pot-by-pot basis. Experienced staff may be

able to offer alternative sampling methods specific to your vessel and sampling concerns.

Taring Your Scale

Generally you will be using some container (e.g., a basket) to weigh your fish. **Remember to tare the scale for this container!** Check your tare frequently and tare every time you change containers! If your scale is not properly tared the weights will not be accurate. For more information see "Taring Your Scales" on page 2-28.

MINIMIZING SAMPLE BIAS

Pot vessels typically dump catch from a pot onto a sorting table. If the pot is one of the randomly chosen sample pots, you must account for all fish in the pot. If all the fish in the pot are collected there is no bias to the sample. If a portion of the catch is taken from the pot to weigh, and the rest tallied, it is possible to bias the sample if the fish are not selected randomly.

When you are collecting fish for weights and biological data be sure to monitor for size bias and minimize this bias as much as you can. Due to safety reasons, you may need to ask the crew to assist with your collection of fish from the table. Be sure that you are monitoring the crew so that they are not hand-selecting the fish or otherwise size biasing your collection. Be assertive with your directions to the crew.

Make rules for which fish you will collect from the table or tote. If the crew are assisting you, make sure they follow the same rules. For example, tell the crew "All the fish in the left hand corner are my weight fish." Be sure to document how you collect your samples in your logbook.

Subset Sampling for Weights and Sex/Lengths

Collecting Weights for Non-Predominant Catch

Typically, you will be able to weigh all the non-predominant species in your sample. ***The observer program expects you to weigh all individuals of a non-predominant species when there are less than 50 in a haul.*** You can collect individuals of non-predominant species over the course of the sample, store them in a container and weigh them in between pots or samples. Try to spread the collection of weight samples over all your samples, rather than taking them from just one sample.

Collecting Weights for Predominant Catch

Typically, the predominant species will be too numerous in your sample for you to weigh every individual. *The observer program expects you to collect and weigh at least 60 individuals of the predominant species for each sampled haul.* Try to spread the collection of weight samples over all your samples, rather than taking them from just one sample. Prior to gear retrieval, randomly determine the pot(s) in a given sample from which you will collect the predominant fish. Do this by numbering the sample pots consecutively from 1 to the total number of pots in the sample. Use the random number table to determine the pot or pots from which to collect catch for weighing. It is often difficult to know exactly how many pots you will need, and you may need to rely on opportunistic sampling on occasion.

Predominant Species Subset Sampling Guidelines

The best method is to count and weigh all of the fish from a randomly selected pot for weight, sex/lengths, and biological sampling, thus eliminating the chance of bias. If there are too many individuals of a species for you to weigh them all, devise a system to avoid hand selection *and always collect fish prior to the crew sorting the fish.* Following are suggestions for collecting fish for predominant species average weights listed in the order of preference:

1. Select all of the fish from a single pot. If you do not get the desired number of fish in the selected pot, continue your collection to the next pot. If there are more fish than desired here are some options:
 - If you have two totes available to collect fish and let the crew dump the pot into the totes. Randomly select one of the two totes and use these fish for your sample. Make sure you have a rule for which tote receives any fish that spill onto the ground.
 - Select half of the fish from the table. Find a divider of some type (for example, a board or your baskets), place it in the middle of the table, and randomly select one side. Collect all the fish from the randomly selected side. Always use a predetermined dividing point.
 - If the catch is dumped into a tote, divide the tote into halves or quarters and select all the fish from a randomly selected side or quarter. Use a divider (a basket lid works well for this) to split the tote into equal parts and randomly select a side to collect fish

for your sample.

2. Collect a small number of fish from the sorting table. Randomly select a corner of the sorting table and take the 5 fish closest to that corner. Do this for four consecutive pots. Randomly select the corner for each collection of 5 fish. This method may be used when storage space is limited.

Regardless of the subset sampling method you choose, be sure to provide a number or a number and weight for all catch encountered in your samples.

When You Cannot Count All the Crab in a Pot

Resource managers manage prohibited crab species (Tanner and king crab) by number and not weight. Occasionally, a pot will contain several hundred crab (typically Tanner species), and counting these crab may take too much time which would adversely affect your ability to maintain your sample size and design. Although *it is preferred that you count all of the individuals*, in this circumstance you are not expected to count all of the individual crab, but you are expected to weigh them. To allow resource managers to use these data, *a subset sample for number and weight must be provided for every sample when it is not possible to count every individual crab.*

If you are overwhelmed with crab, *randomly select about 50 individual crab to identify to species, sex, count, and weigh.* The remaining crab can be scooped into baskets and weighed without providing a total number. *This method is only an option for crab species and crab parts on pot vessels.* All other species must have an actual number associated with them. See “Subset Sampling” on page 2-27 for more information.

The 50 crab that were randomly selected to be counted and weighed may then be reduced to approximately 20 individuals for sex/length and biological data. These individuals must be chosen randomly from unsorted, unsexed crab. See “Sampling for Lengths and Specimens” on page 12-2.

Dealing with Whole Crab Versus Crab Pieces

Document weight data for whole crab only. For our purposes, a crab is considered whole if it is essentially whole by weight. It is not necessary for a crab to be intact to be considered whole.

If you find that a crab in your sample, once whole, is now broken and missing a majority of its weight, you may be

able to determine the species *and you must report the weight of these parts without a number*. Weights that do not represent whole crab are inaccurate from the data user's perspective and negatively impact weight to number relationships otherwise provided by the data.

Whenever crab are reported with a weight and a number of zero you must also provide a subset sample for number and weight. Doing so will allow the observer program to calculate a number of whole crab based on the weight of the parts.

On pot vessels, crab are usually intact and obtaining a number is as easy as counting individuals. If you encounter crab parts along with whole crab in your sample, proceed as follows:

1. Identify all whole crabs to species and report their number and weight. Remember that it is not necessary for a crab to be intact to be considered whole.
2. Identify loose crab parts to the best of your ability. Carapaces should be identified to species and legs can usually be identified to the appropriate genus group code. Report the weight of these parts on a separate line from any whole crab weight/number values and enter a value of zero for number of crab.
3. If there are too many crab and you are only able to weigh, but not count, all of the whole crabs, it is acceptable to weigh crab parts with whole crab of the same species.

Corals

Corals are marine invertebrates that typically live in compact colonies of many individual polyps. In the rare instance you encounter coral in your species composition, the coral should be identified and separated to order using the Corals guide in the Species ID Manual provided. The six major groups of coral in the ID guide include: Hydrocorals, Stony corals, Gorgonians, Black corals, Soft corals, and Sea pens and sea whips. If you are unable to identify the coral, list it as coral unidentified and collect a specimen or take photos with the haul/sample number in them. Specimens should also be collected whenever you encounter a new group of coral. These specimens will be reviewed during the debriefing process.

For pot vessels, all organisms of the same order must be listed with a number of 1 (regardless of the number of individual organisms) with its measured weight. If the

organism is too small to be weighed, a weight of 0.01 kg must be recorded

Tips for Sampling on a Pot Vessel

As the vessel is retrieving gear, there is generally enough time between pots to weigh fish from the predominant species for average weights and to weigh bycatch. There may even be enough time to measure fish for length frequencies.

Small Pot Vessel Time and Sampling Area Management

Many pot vessels under 60ft in length have limited space available for sampling. You may have to reduce the number of predominant species and bycatch you collect if time and space become a limiting factor. If weighing 60 predominant species per haul is too time consuming, reduce it to a more manageable level. ***Collections for predominant species average weights should always be done randomly***. When collecting fish for average weights, have a predetermined number to stop at before your collection begins. Document the circumstances in your daily notes when you are not able to follow the average weight collection protocols under "Species Composition Tally and Weights" on page 10-8.

You may find the key to success on smaller pot vessels is to mix up your duties and alternate the number of samples/duties done per haul. The methods you choose may vary from one haul to the next depending on your assessment of the haul and gear. Space and time are going to be factors in all of your sampling decisions on these vessels and must be considered in collecting average weights. It is important to document all your collection methods.

Subsamples on Pot Vessels

Collecting fish for average weights during your tally sample is always preferred, but there are times when you may need to collect fish for average from outside your tally and record them as a subsample. Collecting fish as a subsample works well when time between pots in your sample is short, there is a space constraint to store fish, or catch rates are high and you need more time to focus and accurately count the catch from a pot. For example, on a Pacific Cod vessel, when storage for collected fish is limited, the predominant species may be collected as a subsample (~20 Pacific Cod require a lot of storage space). If you are reporting information on fish that came

from outside your species composition sample, these data must be recorded as a unique subsample within data. Document your reasons for collecting a subsample. Follow the instructions discussed on page 10-13 for recording subsample data on the Deck Form and on page 18-14 of the ATLAS instructions.

Sampling on Vessels Fishing With Strung Pot Gear

The fundamentals of sampling on a vessel using strung pot gear are the same as vessels using single pots (i.e., tally everything in your sample pots, weigh 60 of the predominant species and at least 50 of the non-predominant species per haul). The time in between pots may be shorter, however, the amount of bycatch is usually minimal. Because of the fast pace, at times it may be difficult to complete all the sampling requirements; be sure that you are familiar with the sampling priority list. If you cannot complete the sampling requirements, contact your inseason advisor or Observer Program field staff and document the problems in your logbook.

COMBINED SAMPLES

The only time you combine sample data on a pot cod vessel is when you are unable to distinguish the tally data of one sample from another. See “Combined Samples” on page 8-19 in the Longline Composition chapter for guidelines.

WHEN THERE ARE NO FISH ENCOUNTERED DURING THE SAMPLE

On rare occasions there will be no fish in one or all sampled pots. Knowing that there are no fish in a sample is just as important to fisheries managers as knowing how many there were. Refer to Figure 10-5 on page 10-18, sample # 3, for an example on how to record a sample where no fish were encountered.

Remember to check the “No Fish in Sample” box on the Deck Form and to write “NO FISH” across the body of the sample block. In ATLAS you simply enter an “N” in the “Species Comp in sample?” box. Please refer to page 18-14 of the ATLAS chapter for information on how to enter these data.

ESTIMATING PERCENT RETAINED

Each species reported in the species composition samples for a haul must have an associated estimation of

percent retained. An individual fish is considered fully retained (100% retained) when more than 15% of its round weight is turned into product. Round weight is the weight of the whole fish, prior to processing. *Percent retained is only an estimation, and your effort and time spent obtaining it should be minimal!*

It is best to enter your estimate of percent retained after the haul is completed because percent retained for each species is done on a haul basis, not by sample. Refer to all the samples collected from the haul for this information. Make your estimation based on what you see happening on a haul by haul basis. In most cases percent retained will be your visual estimation.

If you are on a catcher processor, your estimation of percent retained should reflect what the vessel is retaining on board for each species. If you are on a catcher vessel, everything that is delivered to the processing plant is considered retained. See Figure 10-3 on page 10-16 for an example of recording percent retained on pot vessels.



The percent retained you report for a species must be consistent for that species over all the samples collected during the haul. For this reason, calculate percent retained after the set is completed.

HALIBUT VIABILITIES ON POT VESSELS

The criteria for assessing viability on pot vessels differs somewhat from that used for assessing trawl caught halibut. See page 12-6 and page 12-7 of the Prohibited Species Chapter for instructions. Use the “Halibut Condition Criteria For Pot Bycatch” on page A-53 to assess viabilities on pot vessels. Collect about 10 halibut lengths and viabilities from every sampled haul.

FISH MEASUREMENTS AND BIOLOGICAL DATA ON POT VESSELS

Your duties for collecting predominant and prohibited species measurements and other biological data are the same as for all other vessels. How these duties are conducted may be constrained on a pot fishing vessel by the lack of cooperation from crew. Document any difficulties encountered and the methods you employed in your logbook. If you are having difficulties with cooperation from the crew please see “Specimen Data and Uncooperative Crews” on page 8-23 for further

instructions. Please see “Regulatory Support for Cutting Fish to Obtain Sex Data” on page 13-11 for additional information.

Live Deliveries

Some pot vessels deliver live Sablefish. If the vessel is delivering live Sablefish, the crew will usually not allow you to cut the fish because it will decrease the value of their catch. In this case, you should collect unsexed Sablefish lengths and have the plant observer collect sex length and otolith information during the delivery. Please see “Regulatory Support for Cutting Fish to Obtain Sex Data” on page 13-11 for additional information.

DECK FORM INSTRUCTIONS

Your Deck Forms are an important component of your data documentation. It is important to fill out the forms completely and legibly! *Never recopy or erase raw data and always return to debriefing with all of your original data.*



All raw species composition data that you collect must be documented on the Deck Form provided by the Observer Program, whether or not your vessel has ATLAS. Please write legibly.

The Deck Form is double sided with two sample blocks available on each side. The header information at the top of the Deck Form must be filled out and pertains to both sample blocks below it. *You cannot mix samples from two different hauls on a single side of the Deck Form.* You must maintain a separate set of forms for each vessel to which you are deployed.

Multiple samples and subsamples taken within a haul should be maintained completely independent of each other with their own unique sample number and sample block (or blocks). If you have to combine samples, simply check the circle next to “Combined” for the affected samples (for information on combined samples see “Combined Samples” on page 10-12 of this section or in the Longline Chapter on page 8-19).

As with longliners, weight data from outside the sample are reported as subsample data and weight and number data from within the sample are reported as sample data. Subsamples have a specific numbering system that is associated with the parent sample, explained in “Subsample number” (see below).

The following Deck Form rules must be followed for all pot vessels. All fields must be filled out completely:

Date: Enter the date that the last pot of the haul was retrieved. For the month and the day, use leading zeros when needed (e.g., 01/01/17 for January 01, 2017).

Cruise, Permit: Your cruise number will be given to you during training or briefing, or by your employer. Vessel permits are listed on page A-31.

Haul No., Offload No.: For pot vessel data, leave the offload field blank. For each sample taken within a haul, enter the haul number the sample came from. Hauls can be numbered sequentially beginning with the number 1, or you can follow the captain’s numbering convention if the captain is not repeating haul numbers with each new trip. On pot vessels, it is generally better if you can follow the captain’s numbering system; when hauls are retrieved out of order it can be difficult to track hauls if your numbering system is different.

Haul number must be unique for the vessel. If you disembark the vessel and then embark again at a later date, you can: continue numbering the hauls from the number you left off with, continue with the captain’s numbering convention (if s/he is not repeating haul numbers), or skip a few numbers (i.e., if you numbered hauls of the first trip 1, 2, 3 and 4, you could number hauls of the next trip as 11, 12, 13, 14).



Haul numbers do not have to be sequential (although it is easier if they are), but they do have to be unique for the vessel.

Page_ of_ for Vessel/Plant: For each vessel assignment Deck Form pages are numbered consecutively starting with 1. All forms with raw data must be included in the total pages for the vessel/plant.

Page_ of_ for Haul/Offload: All Deck Forms associated with each individual haul/offload are numbered consecutively starting with 1 of “n” for the haul and it’s associated data. For an example see Figure 10-3 on page 10-16.

Sample number: Every sample taken from within a haul must have a unique identifying sample number. Number samples taken within a haul sequentially, starting with the number 1. You do not need to make sample numbers between hauls unique; you can start with the number 1 for the first sample of every sampled haul.

Subsample number: For pot vessel sample data, the time you will have a subsample is when you are reporting

weight data for fish taken from outside sampled pots. Subsamples must be linked to the parent samples from which they came. You do this by using a numbering convention designed specifically for subsamples. Every subsample number must be three digits in length, with the first digit designating the parent sample from which the subsample came, and the next two digits indicating the number of that subsample for the parent sample. For subsample numbering conventions refer to the Longline Composition “Deck Form Instructions” on page 8-26.

Sample size:

- Samples: every sample must have a sample size. Record the total pots in your sample, and circle the “pots” text.
- Subsamples: subsamples do not have a sample size. Leave the sample size blank for subsample data.

of Sampled Hooks: Leave this blank for pot vessels.

Pre-sorted: Do not check this field. You cannot have pre-sorted samples on pot vessels.

Combined samples: If the samples for a set are going to be combined in the reported data, check the circle next to the word “Combined” for *only those samples that will be combined*. When these data are entered into ATLAS, samples designated as combined are rolled up into a single sample entry. See “Combined Samples” on page 10-12 for a description of when samples must be reported as a “Combined Sample”.

Unable to Follow Design: No longer in use. If you have an older form do not make an entry in this field. When entering data into ATLAS, this field is labeled “Sampled As Designed”. Do not enter this field in ATLAS. It will default to “N” and should be left alone.

No Fish in Sample: Fill this in if no organisms were caught in the sample.

Species: Enter the common name for each species. If a species is too abundant for you to weigh all individuals, you must take a subset sample for number and weight. Enter these data on a separate line from the entry for the individuals of the species that were counted only. Generally you will be able to weigh all of the non-predominant species in your samples. In this instance enter the number and weight for each of the species.

Sex: Tanner crab, king crab, and salmon should be listed separately by species and sex. Record “M” or “F” for these species when sex is determined. *Leave the sex field blank for any unsexed prohibits and for non prohibited species.* Do not record sex codes for any other species even if they were sexed for length samples.

Number: For each species, enter the number of individuals. *Every species entry must have a number recorded!* The two exceptions occur when crab are too abundant to count or if you have an entry for crab parts.

Use as many lines and columns as necessary for each species.

- For decomposed fish (code 899) and miscellaneous items (code 900) enter the actual number of items.
- For subsample data, enter the number of individuals weighed. Unlike samples, subsamples must always have a number *and* a weight.

Weight: For weighed fish, enter the weight by species with a well defined decimal. Weights must be recorded to the nearest 0.1 or 0.01 kg. If you feel that your scale cannot be read accurately to the tenth, you must fill in at least a trailing zero. *Do not enter weights to more than two decimal places. If a species in your sample is too small to weigh (e.g., one brittle star) enter the weight as 0.01 kg.* This holds true for both sample and subsample data.

For organisms that were not weighed, enter zero in the weight field by species.

Percent Retained: This is a rough estimate of the percent of each species retained by the vessel. See “Estimating Percent Retained” on page 10-12.



If the vessel made any product from more than 15% of the fish, the whole fish is considered retained.

Keypunch check: In the spaces to the right of the word “Keypunch”, write the calculated sum for species number and species weight values you recorded for the sample. If your species composition sample has too many species to fit in one sample block, enter the total sums on the keypunch line in the first block for the sample and leave the keypunch line blank for the second block used for the sample.

Keypunch checks are a valuable tool for checking the accuracy of your data entries. The keypunch check for species number should match your tally keypunch (Tally K/P) on the right of the Deck Form.

Length, viability, injury, specimen, tally data: Use the blank area of the Deck Form sample block to record tally data. Use this space to record other sample specific information such as: sex/length information, specimen information, halibut assessments, and notes pertaining to any biases to the sample. Make comments about anything unusual with the catch or your sampling technique for the haul. More complete descriptions of these notes should be documented in your logbook. Making note of unusual occurrences on your Species Composition Form will assist in the debriefing process, and help you distinguish one haul from the others. *Raw data of this sort must be documented!*

Tally K/P box: The tally keypunch box is located on the right-hand side of the Deck Form. This number is the sum of all tallied species which should be recorded on the right side of the Deck Form. The tally keypunch of all the species from the right-hand side of the Deck Form should equal the key punch for species number on the left side of the Deck Form. If there is a discrepancy between numbers in each keypunch, double check your tallies/numbers and compare them to the numbers in your species composition. Remember to include *all species counted and/or tallied* in the tally keypunch. *This is a required field on the Deck Form.*

DECK FORM

| | | | | | |
|----------|--------|--------|----------|-------------|--|
| Date | Cruise | Permit | Haul No. | Offload No. | Page <u>7</u> of _____ for Vessel/Plant |
| 10/22/23 | 22200 | 5137 | 4 | | Page <u>1</u> of <u>3</u> for Haul/Offload |

| | | | | |
|---------------------------------|--------------------------------|------------------------|----------------------------------|---|
| Sample #: <u>1</u> | Sub-Sample #: | Sample Size: <u>12</u> | <small>Kgs Segments pots</small> | # of Sampled Hooks: |
| Presorted <input type="radio"/> | Combined <input type="radio"/> | | | No Fish in Sample <input type="radio"/> |

| Species | Sex | # | Weight | % ret. | Length, viability, injury, specimen, tally data, measurements, bird observations, sample design, notes: |
|----------------------|-------------------------------------|------------|---------------|-------------------------------------|--|
| ----- KEYPUNCH ----- | <input checked="" type="checkbox"/> | <u>443</u> | <u>181.25</u> | <input checked="" type="checkbox"/> | $106 \text{ pots} \times \frac{1}{3} = 35 \text{ pots} \div 3 \text{ samples} = 11.6 \text{ pots/unit} = 12 \text{ pots/unit}$ <p> <u>P. Cod (355)</u> <u>Starfish (16)</u> 41 29 38 30 34 25 32 37 27 30 0 32 </p> <u>Yellowfin Sole (35)</u> □ □ □ □ □ □ □ □ <u>Halibut (1)</u> 1 31-E <u>King Crab (29)</u> □ □ □ □ □ □ □ □ <u>Octopus (1)</u> 1 <u>MYOX (6)</u> □ 1 <p>(* was not able to weigh 3 YFS in last sample pot)</p> <p>start: 1634 end: 1742 Pots pulled <u>□ □ L</u> Tally K/P <u>443</u></p> |
| P. Cod | | <u>25</u> | <u>75.20</u> | <u>100</u> | |
| P. Cod | | <u>330</u> | <u>0</u> | <u>100</u> | |
| Yellowfin Sole | | <u>32</u> | <u>19.40</u> | <u>0</u> | |
| Yellowfin Sole | | <u>3</u> | <u>0</u> | <u>0</u> | |
| Octopus | | <u>1</u> | <u>10.10</u> | <u>100</u> | |
| Great Sculpin | | <u>6</u> | <u>14.50</u> | <u>0</u> | |
| Starfish | | <u>16</u> | <u>1.65</u> | <u>0</u> | |
| Halibut | | <u>1</u> | <u>.30</u> | <u>0</u> | |
| Blue King Crab | <u>M</u> | <u>16</u> | <u>32.80</u> | <u>0</u> | |
| Blue King Crab | <u>F</u> | <u>13</u> | <u>27.30</u> | <u>0</u> | |
| | | | | | |
| | | | | | |

| | | | | |
|---------------------------------|--------------------------------|--------------|----------------------------------|---|
| Sample #: | Sub-Sample #: | Sample Size: | <small>Kgs Segments pots</small> | # of Sampled Hooks: |
| Presorted <input type="radio"/> | Combined <input type="radio"/> | | | No Fish in Sample <input type="radio"/> |

| Species | Sex | # | Weight | % ret. | Length, viability, injury, specimen, tally data, measurements, bird observations, sample design, notes: | | | | | | | | | | | | | | | | | | | | | | | | | | | | | | | | |
|----------------------|-------------------------------------|---|--------|-------------------------------------|--|---|--------------|------|--------|------|--------|------|--------|------|--------|------|--------|-------|--|---|---|------|------|------|------|------|------|------|------|------|------|------|------|------|------|--|------|
| ----- KEYPUNCH ----- | <input checked="" type="checkbox"/> | | | <input checked="" type="checkbox"/> | <p><u>Blue King Crab s/L</u></p> <table style="font-size: small; border-collapse: collapse;"> <thead> <tr> <th>M</th> <th>F (eggs Y/N)</th> </tr> </thead> <tbody> <tr><td>63-L</td><td>64-L-N</td></tr> <tr><td>68-1</td><td>68-□-N</td></tr> <tr><td>73-□</td><td>78-L-N</td></tr> <tr><td>78-1</td><td>83-L-N</td></tr> <tr><td>83-□</td><td>93-1-N</td></tr> <tr><td>113-L</td><td></td></tr> </tbody> </table> <p><u>P. Cod s/L</u></p> <table style="font-size: small; border-collapse: collapse;"> <thead> <tr> <th>M</th> <th>F</th> </tr> </thead> <tbody> <tr><td>57-L</td><td>43-L</td></tr> <tr><td>58-L</td><td>55-1</td></tr> <tr><td>62-1</td><td>62-L</td></tr> <tr><td>64-1</td><td>67-L</td></tr> <tr><td>71-1</td><td>74-1</td></tr> <tr><td>78-L</td><td>78-1</td></tr> <tr><td>74-L</td><td>90-L</td></tr> <tr><td></td><td>98-L</td></tr> </tbody> </table> <p><u>P. Cod o'to's</u></p> <p>sp#1- M/58/3.4 #416321</p> <p>sp#2- M/71/4.2 #416320</p> <p>sp#3- F/74/5.6-Developing #416322</p> <p style="text-align: right;">Tally K/P</p> | M | F (eggs Y/N) | 63-L | 64-L-N | 68-1 | 68-□-N | 73-□ | 78-L-N | 78-1 | 83-L-N | 83-□ | 93-1-N | 113-L | | M | F | 57-L | 43-L | 58-L | 55-1 | 62-1 | 62-L | 64-1 | 67-L | 71-1 | 74-1 | 78-L | 78-1 | 74-L | 90-L | | 98-L |
| M | F (eggs Y/N) | | | | | | | | | | | | | | | | | | | | | | | | | | | | | | | | | | | | |
| 63-L | 64-L-N | | | | | | | | | | | | | | | | | | | | | | | | | | | | | | | | | | | | |
| 68-1 | 68-□-N | | | | | | | | | | | | | | | | | | | | | | | | | | | | | | | | | | | | |
| 73-□ | 78-L-N | | | | | | | | | | | | | | | | | | | | | | | | | | | | | | | | | | | | |
| 78-1 | 83-L-N | | | | | | | | | | | | | | | | | | | | | | | | | | | | | | | | | | | | |
| 83-□ | 93-1-N | | | | | | | | | | | | | | | | | | | | | | | | | | | | | | | | | | | | |
| 113-L | | | | | | | | | | | | | | | | | | | | | | | | | | | | | | | | | | | | | |
| M | F | | | | | | | | | | | | | | | | | | | | | | | | | | | | | | | | | | | | |
| 57-L | 43-L | | | | | | | | | | | | | | | | | | | | | | | | | | | | | | | | | | | | |
| 58-L | 55-1 | | | | | | | | | | | | | | | | | | | | | | | | | | | | | | | | | | | | |
| 62-1 | 62-L | | | | | | | | | | | | | | | | | | | | | | | | | | | | | | | | | | | | |
| 64-1 | 67-L | | | | | | | | | | | | | | | | | | | | | | | | | | | | | | | | | | | | |
| 71-1 | 74-1 | | | | | | | | | | | | | | | | | | | | | | | | | | | | | | | | | | | | |
| 78-L | 78-1 | | | | | | | | | | | | | | | | | | | | | | | | | | | | | | | | | | | | |
| 74-L | 90-L | | | | | | | | | | | | | | | | | | | | | | | | | | | | | | | | | | | | |
| | 98-L | | | | | | | | | | | | | | | | | | | | | | | | | | | | | | | | | | | | |
| | | | | | | | | | | | | | | | | | | | | | | | | | | | | | | | | | | | | | |
| | | | | | | | | | | | | | | | | | | | | | | | | | | | | | | | | | | | | | |
| | | | | | | | | | | | | | | | | | | | | | | | | | | | | | | | | | | | | | |
| | | | | | | | | | | | | | | | | | | | | | | | | | | | | | | | | | | | | | |
| | | | | | | | | | | | | | | | | | | | | | | | | | | | | | | | | | | | | | |
| | | | | | | | | | | | | | | | | | | | | | | | | | | | | | | | | | | | | | |
| | | | | | | | | | | | | | | | | | | | | | | | | | | | | | | | | | | | | | |
| | | | | | | | | | | | | | | | | | | | | | | | | | | | | | | | | | | | | | |
| | | | | | | | | | | | | | | | | | | | | | | | | | | | | | | | | | | | | | |
| | | | | | | | | | | | | | | | | | | | | | | | | | | | | | | | | | | | | | |
| | | | | | | | | | | | | | | | | | | | | | | | | | | | | | | | | | | | | | |
| | | | | | | | | | | | | | | | | | | | | | | | | | | | | | | | | | | | | | |

Verifying sampled pots: you may record the total tally of the predominant species pot by pot, or you may keep a tally of all pots retrieved during your sample collection.

Tally K/P

Ver. 2016

Figure 10-3: Example of Raw Data From a Pot Vessel

DECK FORM

| | | | | | |
|----------|--------|--------|----------|-------------|--|
| Date | Cruise | Permit | Haul No. | Offload No. | Page <u>8</u> of _____ for Vessel/Plant |
| 10/22/23 | 22200 | 5137 | 4 | | Page <u>2</u> of <u>3</u> for Haul/Offload |

| | | | | |
|---------------------------------|--------------------------------|------------------------|-------------------------|---|
| Sample #: <u>2</u> | Sub-Sample #: | Sample Size: <u>12</u> | Kgs Segments pots | # of Sampled Hooks: |
| Presorted <input type="radio"/> | Combined <input type="radio"/> | | | No Fish in Sample <input type="radio"/> |

| Species | Sex | # | Weight | % ret. | Length, viability, injury, specimen, tally data, measurements, bird observations, sample design, notes: |
|----------------------|-------------------------------------|-----|--------|-------------------------------------|---|
| ----- KEYPUNCH ----- | <input checked="" type="checkbox"/> | | | <input checked="" type="checkbox"/> | |
| P. Cod | | 440 | 185.05 | | P. Cod (316) Starfish (23) |
| P. Cod | | 17 | 43.90 | 100 | 17 24 33 28 18 46 |
| P. Cod | | 299 | 0 | 100 | 37 27 15 12 32 27 |
| Yellowfin Sole | | 27 | 19.40 | 0 | Yellowfin Sole (27) Halibut (1) |
| Great Sculpin | | 10 | 23.50 | 0 | Myox (10) |
| Yellow Irish L. | | 34 | 17.60 | 0 | Irish Lord U (34) |
| Octopus | | 2 | 22.30 | 100 | Octopus (2) |
| Starfish | | 23 | 2.50 | 0 | |
| Hermit Crab | | 2 | .10 | 0 | |
| Blue King Crab | M | 13 | 28.60 | 0 | |
| Blue King Crab | F | 12 | 26.80 | 0 | |
| Halibut | | 1 | .35 | 0 | |

Tally K/P
start: 1950 end: 2056 Pots pulled 440

| | | | | |
|---------------------------------|--------------------------------|--------------|-------------------------|---|
| Sample #: | Sub-Sample #: | Sample Size: | Kgs Segments pots | # of Sampled Hooks: |
| Presorted <input type="radio"/> | Combined <input type="radio"/> | | | No Fish in Sample <input type="radio"/> |

| Species | Sex | # | Weight | % ret. | Length, viability, injury, specimen, tally data, measurements, bird observations, sample design, notes: |
|----------------------|-------------------------------------|---|--------|-------------------------------------|---|
| ----- KEYPUNCH ----- | <input checked="" type="checkbox"/> | | | <input checked="" type="checkbox"/> | |
| | | | | | Blue King Crab S/L |
| | | | | | M F (eggs Y/N) |
| | | | | | 78-□ 73-1-N |
| | | | | | 88-L 78-L-N |
| | | | | | 93-□ 83-L-N |
| | | | | | 98-1 88-□-N |
| | | | | | 103-1 98-1-N |
| | | | | | 113-1 |

Tally K/P

Ver. 2016

Figure 10-4: Example of Raw Data From a Pot Vessel

POT VESSEL COMPOSITION SAMPLING: DECK FORM INSTRUCTIONS

| DECK FORM | | | | | Page <u>9</u> of _____ for Vessel/Plant | |
|---------------------------------|--------|--------------------------------|----------|--|--|---------------------|
| Date | Cruise | Permit | Haul No. | Offload No. | Page <u>3</u> of <u>3</u> for Haul/Offload | |
| 10/22/23 | 22200 | 5137 | 4 | | | |
| Sample #: <u>3</u> | | Sub-Sample #: | | Sample Size: <u>12</u> | Kgs Segments <u>0</u> Pots | # of Sampled Hooks: |
| Presorted <input type="radio"/> | | Combined <input type="radio"/> | | No Fish in Sample <input checked="" type="radio"/> | | |
| Species | Sex | # | Weight | % ret. | Length, viability, injury, specimen, tally data, measurements, bird observations, sample design, notes: | |
| ----- KEYPUNCH ----- | X | | | X | <p style="font-size: 1.2em; margin: 0;">P. Cod</p> <div style="display: flex; justify-content: space-around; align-items: center;"> <div style="text-align: center;">o</div> <div style="text-align: center;">o</div> <div style="text-align: center;">o</div> </div> <div style="display: flex; justify-content: space-around; align-items: center;"> <div style="text-align: center;">o</div> <div style="text-align: center;">o</div> <div style="text-align: center;">o</div> </div> <div style="display: flex; justify-content: space-around; align-items: center;"> <div style="text-align: center;">o</div> <div style="text-align: center;">o</div> <div style="text-align: center;">o</div> </div> <div style="display: flex; justify-content: space-around; align-items: center;"> <div style="text-align: center;">o</div> <div style="text-align: center;">o</div> <div style="text-align: center;">o</div> </div> | |

Tally K/P

Figure 10-5: Example of Raw Data From a Pot Vessel

SHORESIDE PLANTS AND FLOATING PROCESSORS

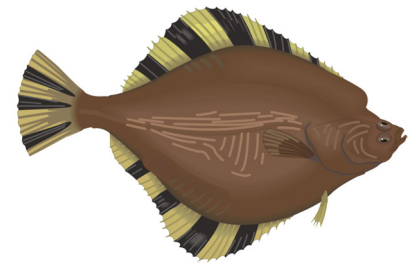

Table of Contents

| | |
|--|-------|
| Introduction..... | 11-1 |
| Delivery and Processing Schedule..... | 11-2 |
| Observer Duties..... | 11-2 |
| Pollock Offload Salmon Monitoring, Sorting and Retention..... | 11-3 |
| Salmon Retention/Genetics Collection, Recording and Reporting..... | 11-3 |
| Pre-Offload Meetings with Industry..... | 11-3 |
| Plant Rules for Bering Sea Pollock Offload Salmon Bycatch Monitoring..... | 11-4 |
| Catch Monitoring and Control Plan..... | 11-5 |
| Bering Sea Delivery Rules and Relief Guidelines for Observers..... | 11-5 |
| GOA Pollock Deliveries to a Full Coverage Category Plant..... | 11-6 |
| Shoreside Plant and Floating Processor Orientation for Vessel Observers..... | 11-6 |
| Collecting Delivery Information..... | 11-7 |
| NMFS Landing Report/ADF&G Fish Tickets..... | 11-7 |
| Verifying Delivery Weights..... | 11-7 |
| Scales..... | 11-8 |
| Deliveries from Tender Vessels..... | 11-10 |
| Jig Boat Deliveries..... | 11-11 |
| CDQ/AFA Information for Plant Observers..... | 11-11 |
| Length Frequency Sampling..... | 11-11 |
| Halibut Deliveries..... | 11-12 |
| Age Structure Sampling..... | 11-12 |
| Research Projects..... | 11-13 |
| Observer Provider Responsibilities..... | 11-13 |
| Referring Sampling Questions..... | 11-14 |
| Gulf Of Alaska Plants..... | 11-14 |
| Salmon Retention Form/Data..... | 11-14 |
| Plant/Vessel Offload Form Instructions..... | 11-14 |
| ADF&G Electronic Groundfish Ticket Instructions..... | 11-18 |

PRIORITIES

- Your safety!
- Collect salmon retention data from Bering Sea pollock deliveries..
- Collect salmon genetic specimens.
- Record delivery information on the Plant/Vessel Offload Form.
- Transmit data to NMFS daily.
- Verify delivery weight.
- Prepare and distribute a Delivery Weight Verification explanation to vessel observers.
- Verify Plant/Vessel Offload Form data.

- Assist vessel observers.

- Collect length and biological specimens.

- Complete research projects.

INTRODUCTION

When you are assigned to a shoreside plant or floating processor, your duties are different from those of a vessel observer. These duties are listed in the following sections. Your primary duty will be reporting salmon retention and salmon genetics data collected from Bering Sea pollock deliveries received by your plant.

As a plant observer your time will be under a great deal of demand. It is important that you understand all of your duties and their relative priority when you arrive.

As with all assignments good communication will be key to your success during your assignment.

SAFETY AT PROCESSING PLANTS

Your highest priority is safety. Each processing plant is different and there are several concerns specific to plants you should be aware of to ensure your safety.

It is very important to always be aware of your surroundings. Here are some examples of things to watch out for at a plant.

1. Forklift drivers often drive around very quickly both on the docks and in the factory. They move fast and may not see you, so you need to watch for them.
2. The docks and processing floors may be slippery with fish slime, guts, and/or ice and snow.
3. Processing plants may be very noisy; you should wear hearing protection.
4. Be aware of cranes transporting equipment or fish on and off vessels (fish pumps and brailer nets). Wear a hard hat to protect yourself against injury.
5. Dock ladders may be slippery (from slime or ice) or in disrepair. Always use three points of contact when climbing a ladder.

Plant observers board vessels daily. It is the expectation of the Observer Program that you wear a PFD every time you cross from the dock to a vessel or vice versa. If the conditions are questionable, do not cross. See “Boarding Vessels at the Dock” on page 19-7 for specific instructions.

This assignment will be very different than sampling aboard a vessel. Please read this chapter carefully, and refer to it often.



Delivery and Processing Schedule

In order to gather data, you will need to know when to expect delivering vessels, when the offload will start, and when the offload will be completed. Most plants have a “radio schedule” between one and three times

daily. From the radio schedule, the plant personnel will prepare a delivery schedule. You will need to either attend the radio schedule, or get a reliable copy of the delivery schedule. It is vital that you communicate with the person(s) responsible for updating these schedules. They are not definitive schedules, and changes occur frequently. Many vessels, such as small jig vessels and IFQ vessels, deliver outside of the schedule and often without prior notice.

You must have an established means of notification for the start of offloads. Plants cannot process Bering Sea pollock without an observer present at the processing line. It is necessary for you to communicate your needs directly to plant management to ensure you receive sufficient prior notification for deliveries from which you are responsible to collect data.

Check in with the plant frequently. Your physical presence at the plant is important, and plant personnel will be more willing to cooperate with a person whom they see on a regular basis. Do not rely solely on the plant to contact you when there is a delivery.

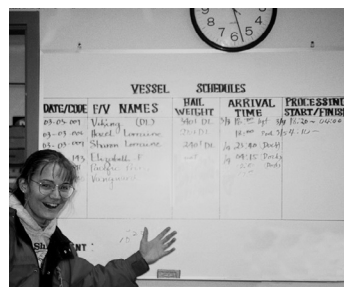

Plant observers often have the unique situation of being on land. This presents opportunities to move about, and it is understood that you will not always be at your duty station. The decision to leave the plant is up to you. **Keep in mind that you are expected to accomplish all plant observer duties. Missing deliveries or failing to monitor Bering Sea pollock offloads, due to being absent from the plant, does not meet Observer Program expectations and this will be reflected in your final evaluation.**

OBSERVER DUTIES

Currently, shoreside plants and floating processors receiving Bering Sea pollock deliveries fall in the full coverage category and are required to have 2 observers. The majority of your time spent at these plants will be monitoring Bering Sea pollock deliveries and collecting salmon genetics and retention data. You will have additional duties that will be completed as your schedule allows. The following are your duties and priorities when assigned to these plants:

- Monitor all Bering Sea pollock offloads for the sorting

of salmon.

- Transmit data to NMFS daily.
- Assist GOA pollock vessel observers with monitoring their pollock offloads.
- Attend pre-offload meetings.
- Collect and report salmon retention data.
- Collect and report salmon genetics data.
- Report delivery information on the Plant/Vessel Offload Form.
- Verify Plant/Vessel Offload Form data.
- Verify delivery weights as time permits.
- Prepare and distribute a Delivery Weight Verification explanation to vessel observers.
- Assist vessel observers as needed.
- Collect length and biological specimens from unobserved vessels.
- Complete research projects.

Plants and floating processors that do not receive Bering Sea pollock deliveries fall into the partial coverage category and are not required to have observer coverage. Observers on vessels that deliver to these plants will have to obtain delivery weight information and their landing report(s) on their own from plant personnel or an Observer Program office. Vessel observers will have to verify their own delivery weights.

It is important to note that you could be assigned to a plant for different fisheries management purposes to conduct additional project specific data collections. For this deployment type, Observer Program staff will provide you with supplementary information and instructions.

Pollock Offload Salmon Monitoring, Sorting and Retention

Monitoring Bering Sea pollock offloads is your top priority while assigned to a plant in the full coverage category. Monitoring an offload means that an observer must be present at all times on the sorting line to watch and verify that all salmon are removed in the designated sorting area by plant personnel. For BS pollock deliveries

the plant observer, with assistance from the vessel observer, is responsible for monitoring the sorting of salmon by plant personnel, collecting biological samples from salmon species, and reporting salmon retention data.

While the data collected from offloads are similar for Bering Sea (BS) and the Gulf of Alaska (GOA) pollock deliveries, there are different sampling protocols during the delivery. Vessels in the directed pollock fisheries in the BS and GOA are prohibited from sorting salmon from their catch and must deliver all salmon to the processing plant. Protocols and rules specific to monitoring and sorting Bering Sea pollock offloads at processing plants are described below. See “GOA Pollock Deliveries to an AFA Plant (Full Coverage)” on page 11-6 for GOA pollock delivery protocols.

Collecting Salmon Retention/genetics information from each pollock delivery is the plant observer’s highest data priority.

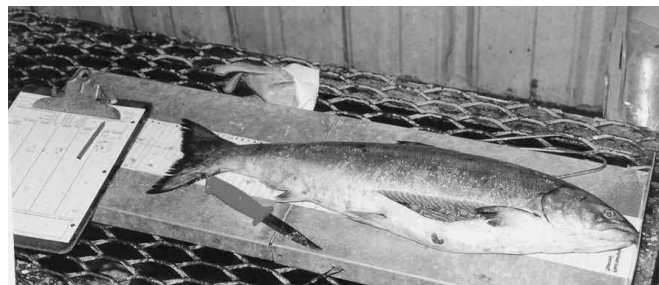

Pre-Offload Meetings with Industry

Pre-offload meetings are essential to ensure *all Bering Sea pollock deliveries* are monitored in their entirety for salmon bycatch. These meetings are expected to take place when a catcher vessel targeting BS pollock comes in with a deckload, has fish in a live tank, or when an interruption of an offload occurs. See “Pre-Offload Meetings with Industry for Bering Sea Pollock Deliveries” on page 2-37 for further information.

Salmon Retention/Genetics Collection, Recording and Reporting

Observers at plants receiving pollock deliveries are responsible for reporting Salmon Retention data and collecting salmon genetics specimens from all Bering Sea pollock offloads. Salmon retention/genetics data are never recorded by plant observers for GOA pollock deliveries. The salmon retention data comes from a count of salmon sorted from the entire offload. Genetics

specimens will be collected from these salmon. An observer must be present on the line during the entire pollock offload to assure proper sorting.

- For examples of how to record salmon retention and genetics data on a Deck Form see “Plant Deck Form Raw Data Example of Bering Sea Pollock Delivery (1 of 3)” on page 11-22.
- See “Salmon Data Collection” on page 12-9 for a full description of salmon data collection protocols for pollock deliveries.
- See “Salmon Retention Data in the Pollock Fishery” on page 12-16 for Salmon Retention reporting instructions.
- See “Salmon Genetics Sampling” on page 12-13 for instructions on collecting genetics specimens.

Any salmon discarded at sea must be included in the retention count.

Catch Monitoring and Control Plan

All shoreside plants and floating processors receiving Bering Sea pollock must have a Catch Monitoring and Control Plan (CMCP). The CMCPs are written by the shoreside processors and approved by NMFS annually. CMCPs describe how the shoreside processor will sort and weigh all catch to species and includes special handling procedures for salmon bycatch. You should be given a copy of the CMCP upon your arrival at the shore side processor.

Each plant’s CMCP will be different so be sure to review each plan carefully even if you have worked at plants before. Contact your inseason advisor or Observer Program staff if you have any questions about the specifics of your plant’s CMCP or if the plant’s operations differ from what is described in the CMCP

The CMCP plan should:

- Identify a plant liaison. This person is responsible for orienting new observers to the plant and assisting with the resolution of observer concerns.
- Detail the size and location of space for sorting catch.
- Identify by serial number each scale to be used to weigh groundfish and describe each scale’s use.
- Describe the procedure used to test the plant scales. Observers are not required to request scales be tested or be present when scales are tested. There are no daily

test requirements for the plant’s scales.

- Identify the delivery point. The delivery point is the first location where fish can be sorted.
- Designate an observation area. This observation area is the location where an individual may monitor the flow of fish during a delivery.
- Identify an observer work station. This station should include a platform scale, a table, and a lockable cabinet. Test weights should be available to test the platform scale. The scale needs to be tested at 10, 25, and 50 kg on a daily basis and the results should be documented in ATLAS. You should be able to walk between the work station and the observation area without encountering any safety hazards.
- Describe the communication equipment for the observer to facilitate communication with plant personnel.
- Be accompanied by a scale drawing of the plant showing the delivery point, the observation area, the observer work station, the location of each scale used to weigh catch, and each location where catch is sorted.

Plant Rules for Bering Sea Pollock Offload Salmon Bycatch Monitoring

There are strict standards related to salmon handling that must be followed for Bering Sea pollock offloads. These standards listed below must be followed and are addressed in each plant’s Catch Monitoring and Control Plan (CMCP).

1. Sorting and weighing of the delivery should occur within view of the observation area designated in the plant’s CMCP. The observation area must have a clear, unobstructed view of the salmon storage container.
2. Ensure no salmon pass beyond the designated sorting point as identified in the CMCP. All salmon must be sorted by designated plant personnel from the offload and placed in the designated salmon storage container identified in the CMCP.
3. As part of the CMCP a work station is provided for the observer. The work station is adjacent to where the observer counts and collects biological information.
4. It is the plant’s responsibility to ensure all salmon are properly sorted from the offload.

5. If the salmon container becomes full at any point in the delivery, the offload must cease until the observer has completed the count and collected all biological samples from the salmon bin before the offload can resume.
6. Once the observer has completed sampling, the salmon must be removed from the area in the presence of the observer.
7. The observer must be given the opportunity to complete the count and biological data collection before the next delivery begins.
8. No salmon may be removed from the sampling area until after the observer's duties are completed.
9. Pre-offload meetings must be conducted when catcher vessels bring in deck loads (fish in codends and/or loose fish on deck) or fish in the live tank.
2. Both plant and vessel observer must be available for the pre-offload meeting if one is required.
3. The plant observer and vessel observer each monitor about 50% of the offload. This will allow the plant observer time to complete other plant duties and give the vessel observer time to transmit data, contact NMFS as needed, etc. The plant observer may need their relief at any time within the offload, but it is expected that the plant observer start each offload (take the first shift). If you cannot take the first shift you must document the reasons in your logbook.
4. The plant observer is responsible for reporting the salmon retention data and collecting biological data. The vessel observer assists the plant observer as needed with biological data collection.
5. Near the beginning of each offload, you should meet with the vessel observer to coordinate the schedule to ensure the offload is monitored 100%. When deciding on the schedule, it is important to keep in mind your other duties and the possibility of the vessel observer having to leave before the completion of the offload.



Vessel observers may assist with biological sample collection but at no time should one observer be collecting samples while the other is watching the offload.

Bering Sea Delivery Rules and Relief Guidelines for Observers

Monitoring the pollock offload is a shared duty between the plant observer and vessel observer. It is required that all pollock offloads are monitored 100%. *This is the highest priority for all Bering Sea pollock deliveries.* Relief provided by the vessel observer is to allow the plant observer to perform other duties. The following guidelines are to be followed for Bering Sea pollock deliveries.

Bering Sea Pollock: Plant Observer Offload Guidelines

Monitoring the offload of a BS pollock delivery is your highest data priority.

1. Both the vessel and plant observer are required to participate in the monitoring of the offload and both must ensure the offload is 100% monitored. Only one observer is required to be present at any given time during the offload. The vessel observer may assist the plant observer with biological sample collection but at no time should one observer be collecting samples while the other is watching the offload.
7. Break schedules must be recorded in your Daily Notes and on the Deck Form. You will likely need relief periods for meals, time to do paperwork, verify delivery weights, sample other delivering vessels, and to complete other plant duties.
8. The plant and vessel observers are required to be present at the beginning and end of each offload. The vessel observer should be present at the end of the offload to assist with salmon data collection if needed. The only exception is when the vessel observer has to leave because the vessel decides to go out fishing before the completion of the offload.



By federal regulation, pollock catcher vessel observers must not be assigned to another vessel or sent to debriefing prior to completing their sampling duties.

Actions resulting in the offload not being 100% monitored will reflect poorly on the observer's work performance evaluation.

The plant is required to stop sorting fish during the salmon count and while biological specimens are collected. It is not acceptable for one observer to watch the sorting line while the other is counting salmon or collecting biological specimens from salmon.

Bering Sea Pollock Vessel Observers

See "BS Pollock Offload Salmon Retention Count" on page 5-29 for your responsibilities for a BS pollock delivery.



The offload must be monitored in its entirety. Salmon retention data is your number one data collection priority during your delivery.

GOA POLLOCK DELIVERIES TO A FULL COVERAGE CATEGORY PLANT

Plants in the full coverage category will occasionally receive deliveries of GOA pollock. As the plant observer, your duties for a GOA pollock delivery differ from the duties for a BS pollock delivery.

- You are not required to monitor unobserved GOA pollock vessel deliveries nor report Salmon Retention Data from these offloads.
- If it is an observed vessel you are expected to give the vessel observer breaks following the same 50/50 guidelines as a delivery of Bering Sea pollock on page 11-5.
- The vessel observer is responsible for completing an offload salmon retention count, reporting this information on their Salmon Retention Form in ATLAS, and for the collection of salmon genetic samples and FMA ID scales. See "GOA Vessel Observer Offload Salmon Retention Count Guidelines" on page 12-18. If the vessel observer is not available to do so, check for after scale salmon. If there are any remaining salmon biological data to be collected, you are responsible for collecting these data according to the GOA salmon biological data collection guidelines. Do not enter this information into your data. Notify your inseason advisor that you have salmon data for the vessel observer and await instructions.

- The salmon sorting, count, and identification for the vessel observer's offload salmon retention count may be done during the offload, not at the end. Record this data for the vessel observer while monitoring the offload. Make sure you are familiar with the vessel observer's Deck Form before taking over the offload. See "GOA Vessel Observer Offload Salmon Retention Count Guidelines" on page 12-18 to familiarize yourself with GOA vessel observer offload duties and expectations.
- Be sure to communicate to the vessel observer the plant protocols for sorting and monitoring. The plant may choose to continue to follow their standard Bering Sea sorting process for deliveries from the GOA.
- For unobserved GOA pollock deliveries collect sex/length and otoliths from pollock (see "Length Frequency Sampling" on page 11-11).

Shoreside Plant and Floating Processor Orientation for Vessel Observers

It is very important to keep in contact with vessel observers delivering to your processor. When possible, it is expected that you meet all observed pollock vessels. This is necessary for you and the vessel observers to coordinate shifts for monitoring and sampling of the offload and to provide contact information. You will need to give each vessel observer a tour of the plant and explain to them your delivery weight verification process. The tour of the plant should include:

- Potential safety hazards and emergency contingencies. Document these in the "Plant Orientation Summary" in your logbook.
- The area in which the offload will be monitored for salmon bycatch.
- The "after-scale" area for non-AFA pollock deliveries.
- A description of the plant's salmon sampling area and the salmon containers.
- Areas of potential size or composition bias (sorters, incline belts, etc.).
- The location of the office, phone, fax machine, and computer.
- Where they can obtain verified delivery weights, fish tickets, and messages from you.

You will need to ensure vessel observers are able to reach you whenever they are in and during their offload. They will need your assistance to obtain delivery data from previous deliveries. Most plants provide their plant observers with cell phones. Remember, this cell phone is to be used for plant business only. Most plants have a phone at the dock or in the office that the vessel observer may use to contact the plant observer. Be sure to note the location of this phone during your orientation tour. You may have to establish a “message board” which is accessible 24 hours a day.

COLLECTING DELIVERY INFORMATION

One of your duties is to gather information about the various vessels delivering to your plant. These data are recorded on the Plant/Vessel Offload Form. Each day you are assigned to the plant must be accounted for on this form even if there are no deliveries that day. The information required for the Plant/Vessel Offload Form can be obtained from the NMFS landing report, commonly referred to as the ADF&G fish ticket. If you have questions regarding delivery information on the fish ticket, you can verify it by speaking with the vessel observer, talking to plant personnel, consulting the vessel logbook or asking the captain of the vessel.

NMFS Landing Report/ADF&G Fish Tickets

The species delivered and weight information is reported by the plant using the NMFS Electronic Landing Report, often referred to as “E Landings” report, and is printed out as the ADF&G Electronic Fish Ticket. The whole weight of the species in each delivery is listed on the fish ticket with a summary at the bottom, referred to as the “notes section.” The round weights of the delivered species are totaled and listed on the fish ticket in the **Observer Only** box in the “Total Round Weight” field. This weight should be entered on the Offload Form.

An ADF&G fish ticket is the most reliable way to obtain verified delivery weights, therefore it is important that they are read correctly. Familiarize yourself with how plant personnel completes a fish ticket, where their data comes from, and that it is acquired accurately. The processing plant office personnel will familiarize you with their method of completing the fish ticket. See “ADF&G Electronic Ground fish Ticket (examples)” on page 11-19.

Information on the ADF&G fish ticket is confidential and cannot be shared with anyone but the delivering vessel’s observer. You may fax (never email or photograph) fish tickets for vessel observers to Observer Program offices in Dutch Harbor, Kodiak, Anchorage, or Seattle if requested by the vessel observer. **DO NOT fax fish tickets to contractors or to other plants; it is confidential information!**

VERIFYING DELIVERY WEIGHTS

Verification of delivery weights is one of your plant duties. You must become familiar with all processing operations and the flow of fish. You must be able to say to the best of your knowledge that the delivery weight on the fish ticket is correct. You need to provide delivery weights to vessel observers and verify delivery weights for your offload form. Things to ask yourself:

- Are all species delivered present on the fish ticket?
- Does the plant sort by species and are species recorded separately on the fish ticket?
- Is the total weight on the fish ticket correct?
- Are the product codes correct for each species?

Once you are familiar with how the fish ticket is prepared and have established that there are no errors, you may spot check landing reports throughout the week, keeping in mind that your priority is monitoring pollock deliveries.

Document in detail all verification methods used in your Daily Notes and show all calculations in the “Additional Calculations” pages of your logbook or show calculations on the fish ticket.

Verification Methods

During your first few days at the plant you should determine the best method for obtaining delivery weight information. Two methods are:

1. Interpret the ADF&G fish ticket.
2. Sum the scale weights.

Using the ADF&G fish ticket, also known as the landing report, is the most common method to obtain delivery information. Verify the weights entered on the fish ticket by comparing the numbers with other documents where weights of fish are recorded such as “dock tallies” and

“scale reports”. If the summed scale weights do not match the fish ticket weight, inform the plant of the discrepancy and contact your inseason advisor or Observer Program staff.

Should you determine that the ADF&G fish tickets are *not* reliable, do not use the fish ticket amount for delivery weight. Document this in your Daily Notes and tell your inseason advisor why you are using a different method to obtain delivery weight. Summing the actual scale weights for a delivery weight is usually only feasible for very small deliveries.

Plants use various means to record species and weights. They may use any combination of the methods listed below to track species and calculate the actual data they record on the final fish ticket.

- Tote or brailer weights may be recorded by hand on a sheet of paper with the species listed at the top of the column or the weight may be entered into a computer with a code for the species. Watch for incorrect species code entries resulting in the wrong species appearing on the fish ticket.
- Hopper scales record weights electronically. The plant may print all of these weights or only the totals. Check the original records, sometimes referred to as ticker tape readouts. If the catch is weighed and then sorted there will be tote weights of bycatch subtracted from the final hopper scale weight and this should match the landing report.

Large Offload Verification

For large deliveries (e.g., pollock) you might be available at the end of the offload to note the weight on the hopper scale readout. Note if the hopper scale readout includes all fish or if the bycatch is sorted out prior to being weighed by the hopper scale. If bycatch has been sorted out watch these sorted fish being weighed and note this on your Deck Form. The total delivery weight will be the sum of the hopper scale readout and the weight(s) of the sorted bycatch or just the hopper scale readout if no fish were sorted out. Compare the totals you obtain from the readout to the fish ticket. This verification should be done as often as possible. This is not the same as simply summing scale reports from deliveries when you were not present.

Small Offload Verification

For small offloads the plant may record tote or brailer weights on hand written sheets as fish are weighed, and then sum the weights to obtain a delivery weight. When the fish ticket is available you can compare these numbers to the fish ticket. This is usually done on smaller deliveries (under 50,000 lbs) of mixed catch such as a Pacific Cod catcher vessel. This verification should be done when possible.

Delivery Worksheet Verification

You will need to let each vessel observer know how you are obtaining delivery weights. This is a very important task that is crucial to the vessel observers delivering to your plant. To do this, prepare a written paragraph or two explaining how the delivery weights are verified. In this description, you will need to address each of the concerns regarding verifying delivery weights listed under “Verifying Delivery Weights” on page 11-7. Include details about how fish are removed from the vessel and how they get into the plant, where they are weighed, and how the sorting will occur. Make several copies to give to the observers delivering to your plant. Examples of such descriptions are shown in Figure 11-1.

Scales

Plant hopper, tote, and hanging scales are required to be tested annually by the State of Alaska and display panels are sealed and protected against tampering. Therefore,



it is not necessary to verify that the scale displays the correct weight. Plant scales are sometimes tested daily, but a daily test is not required. Plant observers need to check that plant personnel are recording the weights accurately and that the entire delivery is weighed.

Items to check on scales:

- Does the scale weigh the entire catch, or is bycatch sorted out first and weighed separately?

Alaska Processing Inc. Delivery Weight Verification Cell: (907)-359-5555 Office: (907)-555-5555

For All Vessel Observers:

We will verify the delivery weight for each delivery in the following manner:

Delivery weights are usually taken from “Total Round Weight” on the ADF&G electronic fish ticket. The plant manager does not want us giving out copies of the fish ticket, so we will give you a sheet with the Total Round Weight once we have verified the fish ticket information. If we see code 92 or 95 we’ll ask you if those fish were offloaded and weighed at the Plant. That will determine if they need to be added to the delivery weight or not. If we find any discrepancies during the verification process, we will include that information for you. (We checked all the fish tickets during the first week and never found any discrepancies.)

All bycatch weights are double checked against the tote weights from the dock tally. (These are also stapled to a copy of the fish ticket.)

We try to check the dock tally once a day during a non-observed delivery. The tote tare weights are checked, and we check to ensure the forklift drivers are recording the information correctly. If you notice any totes being weighed incorrectly during offloads, be sure to let us know!

No water weight is deducted at this plant.

All Bering Sea Pollock Offloads: Please let us know of any at-sea salmon discards as we’ll need this information for the Salmon Retention data! We need to track after-scale for the salmon retention data so let us know if you get any after-scale salmon during your offload when you are relieving us.

Bering Sea Pollock Offloads

Come find us when you arrive at the plant and we’ll go over monitoring the offload and a schedule. You can call the cell phone, find us in the office, or if there is a pollock vessel offloading, we will most likely be on the line monitoring the offload for salmon. Let us know roughly how many salmon we might encounter in the offload.

Gulf of Alaska Pollock Deliveries

Come find us when you arrive at the plant and we’ll go over how we can assist you with your salmon retention count and when your offload will be scheduled to start. We can discuss the schedule for breaks and how you want me to record data for you. If we get any after scale salmon (after you have left) I will collect genetics samples for you and let the Observer Program know we have them.

Thanks!

Figure 11-1: Delivery Weight Verification Process (example)

- Do summed scale readouts equal the total delivery weight on the ADF&G fish ticket?
- When time permits, watch the scale readout in the factory to make sure it is weighing properly. Does the fork-lift driver record weights for every tote? Is the scale tared, and how frequently?
- Are product codes on the fish ticket accurate?

If you notice any discrepancies inform plant personnel, document, and notify NMFS.

The electronic platform scale provided at AFA plants for use at the observer sample station must be tested daily by the plant observers.

Round (Whole) Weight Delivered

Round weight is the weight of the entire fish, as it was when it was alive. In some fisheries, such as Pacific Cod and Sablefish, the catcher vessels begin processing their catch at sea. For these deliveries, the weight listed in the main body of the fish ticket will be the processed weight of the fish delivered. Pacific Cod is usually bled and Sablefish are usually headed and gutted. Since parts of the fish have been removed prior to delivery, the recorded

delivery weight must be adjusted to represent a *delivery round weight* using Product Recovery Rates (PRR). The calculated round weight for individual species is listed at the bottom of the fish ticket (referred to as the notes section), as “delivered” or “discarded”.

The NMFS Electronic Landings Program, used by all plants, calculates the delivered round weights and sums them in the Observer Only section under the “Total Round Weight” field in the bottom right of the fish ticket.

See “Product Recovery Rates (PRR)” on page A-22 for information about PRR codes and calculating round weight.

Delivery weight calculations may be recorded in your logbook or on the fish ticket. Observers who calculate delivery weight on the fish ticket do not need to transcribe it into their logbook, provided the observer includes the fish ticket with their final data turned in to the Observer Program at debriefing. As with any calculation do not round until the final weight and be sure to label all your numbers.

Large Organisms in the Delivery

You must verify that everything delivered to your plant is accounted for in the ADF&G fish ticket. For pollock deliveries, there are occasions when sharks and other large organisms are delivered but not weighed because they were too big to be pumped into the factory. *It is your responsibility to ask the vessel observer (if one is assigned) or the plant dock workers if this occurred to make sure anything not weighed is accounted for in the ADF&G fish ticket.* These items should be recorded as code 99 (code 99 is anything delivered but not made into product and /or discarded at the plant).

Fish Retained for Bait and Personal Use

The “Total Round Weight” will not include fish retained for personal use (code 95), retained for bait (code 92), or “Other use” (code 97). Delivering vessels usually do not offload these to the plant. If these codes are present on the fish ticket, it is your responsibility to work with the plant, vessel, and/or vessel observer to verify if those fish were delivered and weighed at the plant. If they were, those fish must be included in the total delivery weight. If not, exclude those fish from the total delivery weight. The exception to this rule is for IFQ halibut and Sablefish deliveries. Due to IFQ retention rules, all retained IFQ halibut and Sablefish (including fish retained for bait or personal use) must be weighed at the plant and be

included in the Observer Only box under “Total Round Weight”.

Properly Recorded Weight Data

If you find that the fish ticket weights are recorded properly, continue verifying one or two deliveries per day. In your logbook, document how you are checking these weights. Also, document your reasoning for using the method, and any problems or concerns you may have with the data.

Improperly Recorded Weight Data

If you determine that data are consistently not being recorded accurately at your plant, contact NMFS. You may need to start verifying as many delivery weights as possible. Document how the fish ticket and delivery information are recorded by the plant personnel, and what you think the problem is. Notify your inseason advisor. The problem may be easy to correct. In the Pacific Cod fishery, the catch is often weighed in totes. If the totes are not properly tared, the delivery weight will be inaccurate. Check the tare weight by asking the forklift drivers to weigh empty totes for you. If you find that the totes are not being weighed properly, you must work with the dock personnel to assure the problem is corrected or calculate the weights yourself.

DELIVERIES FROM TENDER VESSELS

Tender boats are vessels which receive catch from one or more catcher boats and deliver it to a plant for processing. They do not carry observers and are not designed to process any fish. Tender vessel deliveries are potentially sorted and are usually from several different catcher vessels. Tenders will issue their own ADF&G fish tickets to delivering vessels. The fish ultimately delivered to your shoreside plant will have several fish tickets associated with them. These must be combined into one line on the offload form. When documenting these deliveries on the Plant/Vessel Offload Form follow the protocols below (see Figure 11-5 on page 11-21 for an example).

- Record:

1. Completion Date. Enter the Tender Dock Offload date found on the Fish Ticket on the bottom right hand corner, above the Observer Only delivery weight box. This date should indicate when the Tender Offload begins.

2. The offload number.
 3. Gear type. If the tender delivers fish caught by more than one gear type, enter the gear type used for the majority of the delivery.
 4. The total weight delivered from all of the fish tickets for that offload.
 5. The ADF&G number of the tender vessel.
 6. The Elanding Management Program (EMP) code. If the tender vessel delivered fish from multiple EMPs, record the EMP where the majority of the fish were caught.
- Do not record a Landing Report ID Number on the Plant/Vessel Offload Form.
 - Do not record the NMFS area fields on the Plant/Vessel Offload Form.
 - Do not collect length/specimen data from tender vessels.
 - Do not collect salmon genetics or salmon retention data from tender vessel deliveries.



Deliveries from pollock tender vessels are not sampled for salmon genetics. Salmon from tender deliveries are never included in the salmon retention data.

Jig Boat Deliveries

Record the delivery information on the Plant/Vessel Offload Form. Sample for sexed lengths and otoliths unless a state port sampler is present and sampling the offload.

CDQ/AFA Information for Plant Observers

Plant observer duties vary depending on the type of vessel delivering and the fishery the vessel participated in. The 12-hour rule applies during both CDQ and AFA fisheries at all plants (see “Lead Observer’s Role” on page 2-36).

Plants are required to weigh all CDQ species on certified scales. Unlike flow scales, there is no daily test requirement for the plant. The State of Alaska tests and certifies scales at plants.

CDQ Deliveries

For fixed gear catcher vessels, delivery weights are used to manage the CDQ quota. It is the plant observer’s responsibility to verify delivery information.

Plant Observer Duties for CDQ Deliveries

The plant is required to notify you of CDQ deliveries and all CDQ species must be sorted and weighed by species. If no groundfish are delivered, you have no sampling responsibilities as the plant observer but must still include the delivery weight on your Plant Offload Form.

All halibut Prohibited Species Quota (PSQ; under size halibut for CDQ halibut boats) and crab must be discarded at sea. To the best of your ability, familiarize yourself with the plant’s sorting and weighing activities. Notify your inseason advisor if the plant is not complying with the regulations.

TARING YOUR SCALES

Generally you will only use your brass scales to weigh fish from non-pollock deliveries. An electronic platform scale will be provided by the plant and used for weighing salmon specimens from Bering Sea pollock deliveries. You are required to test the electronic scale as you would the MCP on a vessel. See “Platform Scale Testing” on page 2-30 for testing guidelines. Be sure to check that the weight indicator is at 0.0 kg when the scale has no weight on it. If you use a container (e.g. a basket) to weigh your fish *remember to tare the scale for this container! Check your tare frequently and tare every time you change containers!* If your scale is not properly tared the weights will not be accurate. For more information see “Taring Your Scales” on page 2-28.

LENGTH FREQUENCY SAMPLING

For plant observers in the full coverage category collecting length frequency data is a lower priority than completing the offload salmon retention count, collecting salmon retention data, and verifying delivery weights. Please see “FISH MEASUREMENT AND SPECIMEN COLLECTION” on page 13-1 for instructions on how to collect a length sample and how to sex and measure fish. Do not sample exempted/experimental fisheries.

Be sure to work closely with plant personnel at your plant to ensure you minimize your effects on the product quality when collecting length and specimen data.

Plant observers take 20-30 sexed lengths per unobserved delivery that was not size sorted at sea. Selection of sampled fish is based on the “Length and Specimen Priority List for Plants and Floating Processors” on 13-30.

You need to take lengths from deliveries meeting the following criteria:

- The delivery is from a vessel with no observer onboard.
- *There is no at-sea discard of the roundfish target species associated with the delivery.* Prior to gathering lengths, ask the captain or a crew member if any of the target species was discarded or consumed at sea. At-sea discards could introduce a size bias, and lengths should not be taken. If all roundfish deliveries are sorted at sea, do not take lengths. The exception to this rule is for the flatfish fishery.

If you find that the majority of delivering vessels are carrying observers, or if all targeted roundfish species are sorted at sea, you may not be able to collect lengths everyday. If only a few of the vessels meet the above criteria, track these boats carefully and take lengths from their catch whenever they deliver.

Note that plant observers:

- **Do not** collect pollock length-weight samples.
- **Do not** collect lengths/specimens from tender deliveries.
- **Do not** collect sex/lengths/specimens on trawl caught Pacific Cod, but you may collect lengths/specimens from other species in a trawl cod delivery.
- **Do** collect lengths and otoliths from species from jig deliveries *unless* an ADF&G port sampler is present and sampling.
- **Do** collect lengths and otoliths from observed vessels that *deliver live Sablefish*, provided the vessel observer was unable to collect these data.
- **Do** collect lengths and otoliths from groundfish bycatch delivered by halibut vessels.

If more than one preferred target species is delivered, you should take lengths from each delivered species, up to 3 species per delivery. Take 20-30 sexed lengths per sampled delivery for each target species. Please refer to page 13-11 for the correct methods to sex and measure different species of fish. Your plant may be accepting

various species of flatfish during your deployment. You may be able to gather lengths on several of these species. Flatfish vessels will always sort at-sea for preferred species. During this process, some size sorting may occur. If all the flatfish vessels delivering to your plant report at-sea sorting of delivered species, take lengths anyway, and document this in your logbook.

Collect your lengths using a random sampling design. Be sure to record the correct sample design type for your length and specimen data (see “Completing the Length and Specimen Form” on page 13-16). If unsorted mixed fish are delivered, divert the flow of fish to half fill a basket. Sex and measure all species in the basket that are present on the priority list. This will allow you to take randomly collected lengths on a variety of species at once. Fill out the Length and Specimen Form according to standard directions (see page 13-16).

Halibut Deliveries

When IFQ boats fish for halibut, they are required to keep all incidental catch of rockfish, and abide by IR/IU regulations by keeping some or all pollock and Pacific Cod. You may be required to sample the unsorted groundfish bycatch delivered. Use the plant length and specimen priority list for roundfish when sampling bycatch from a halibut delivery. Halibut are never sampled at the plant.

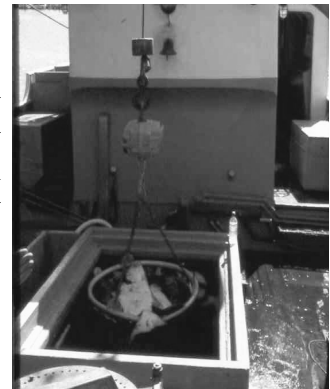

Use a Deck Form to record and keep your raw length and specimen data. You must submit your raw data during debriefing in an organized and consistent format. The observer program does not have a plant specific Deck Form so you must adapt the vessel Deck Form to plant data. Figure 11-6 on page 11-22 is an example of how observers have adapted the Deck Form to accommodate biological data collected by the plant observer.

AGE STRUCTURE SAMPLING

The collection of otoliths is a standard duty for plant observers. Otoliths should be collected from every

delivery from which you take lengths. Follow the length priority lists on page 13-30 to determine from which species to collect lengths and otoliths. Otoliths must come from fish that are in your length frequency sample. If you are unable to complete both a length and otolith collection for a delivery, the otolith collection takes priority. Document the reasons why all duties were not completed.

Refer to Otolith Specimen Collection on page 13-8 for collection methods. The number of otoliths you collect each day will depend on the number of target species being delivered to your plant. You should try to collect at least 5 otoliths per delivery sampled for lengths. Collect otoliths according to the following frequencies:

- If only one species is being delivered that is measured for length frequencies, collect five pairs of otoliths per delivery sampled for lengths.
- *If two or more species listed on the Length and Specimen Priority List are delivered in the same offload from an unobserved vessel, take two pairs of otoliths from each species.*
- Try to collect otoliths from as many deliveries per day that meet length frequency collection criteria, keeping in mind your other higher priority duties.

Note that you should not take otoliths from Arrowtooth Flounder or trawl caught Pacific Cod. Remember that if you are collecting otoliths from pot or longline caught Pacific Cod, the fish will likely have been bled before delivery. If this is the case, you must divide the weight of the individual fish by the PRR of 0.98. Show your calculations in your logbook or on the Deck Form, and record the calculated weight on the Length and Specimen Form. The Length and Specimen Form should be filled out according to directions on page 13-16.

Sampling Example:

A plant observer sampling a longline vessel delivery that targeted Sablefish in the BS and retained rockfish and Pacific Cod, follows the roundfish priority table (13-24 13-29). Length and otolith collection would consist of the following:

1. Sablefish - 20 sex/length fish and 2 otoliths.
2. The most predominant species of rockfish: 20 sex/length fish and 2 otoliths.

3. Pacific Cod - 20 sex/length fish and 2 otolith pairs.

This would be a total of up to 60 sex/length fish and 6 pairs of otoliths collected from this delivery.

RESEARCH PROJECTS

Plant observers have the unique arrangement of having access to lots of fish, freezers, field offices, and airports. Therefore, they will frequently be asked to complete fish collections for training use. If you are asked to collect fish, please work with plant personnel to obtain secure, easily accessible freezer space in which to store your collection. During fisheries where sorting at sea is common, you should work with vessel observers to collect requested species. The research project will be assigned to you. If the vessel observer can not assist, you are still responsible for completing it. Please note that prohibited species cannot be collected without a permit. When you are selecting fish to collect, try to choose fish which have just been delivered and freeze them individually. Rockfish spines should be folded down, and *the fish frozen flat*. Small fish are preferred, since more fit in a box, but do not hesitate to bring back fish that are outside of normal size or geographical range. The Observer Program needs to verify any species reported outside these ranges.

Although fish collections are a common research project assignment, there are many projects that maybe assigned. Contact an Observer Program office if you have questions about your project, or if you are having difficulty completing it while keeping up with your other duties.

OBSERVER PROVIDER RESPONSIBILITIES

Observer provider companies are responsible for logistics to deploy and maintain observers aboard fishing vessels or at the processing facility. This includes all travel arrangements, lodging, per diem, and any other services required to place observers aboard vessels or at processing facilities. Each observer deployed to shoreside processing facilities shall be provided with a working cell phone or pager for notification of upcoming deliveries. If you are unable to perform your duties as an observer because there is no reliable transportation to the plant, please contact the Observer Program. If your accommodations are inadequate, document this in your

Daily Notes, contact the Observer Program, and let your employer know about the problem.

REFERRING SAMPLING QUESTIONS

Plant observers are a tremendous help to vessel observers, but it is important that they do not overstep their boundaries. *Plant observers should not answer sampling questions that do not pertain to their plants.* Vessel observers should be encouraged to contact an Observer Program staff member if possible. If the observer is not at the plant during Observer Program hours, have them write their question down and fax it to one to the Observer Program offices. Give the written response back to the vessel observer. Do not interpret answers or relay the answer to the observer. Follow the same procedure for an inseason message if you relay the questions via ATLAS or email.

ADF&G PORT SAMPLER

There may be an ADF&G port sampler during some fisheries in the Gulf of Alaska (Kodiak and Sand Point). Collect salmon retention data and associated lengths specimens regardless of whether or not it the offload is sampled by an ADF&G port sampler. Do not collect sex/length and otolith data from a delivery if the port sampler is sampling it. You may need to coordinate with the ADF&G port sampler on a daily basis to avoid sampling the same deliveries. All eligible deliveries should be sampled.

GULF OF ALASKA PLANTS IN THE PARTIAL COVERAGE CATEGORY

Plants and floating processors that do not receive Bering Sea pollock deliveries fall into the partial coverage category and are not required to have observer coverage. Observers on vessels that deliver to these plants will have to obtain delivery weight information and their landing report(s) on their own from plant personnel or an Observer Program office. Vessel observers will have to verify their own delivery weights.

SALMON RETENTION FORM/DATA

Salmon Retention data must be entered in ATLAS by the plant observer for all Bering Sea pollock deliveries and by the vessel observer for all GOA pollock deliveries. Plant observers do not enter salmon retention data from GOA pollock deliveries. See “Salmon Retention Form

Instructions” on page 12-19 for instructions on recording this data in ATLAS.

PLANT/VESSEL OFFLOAD FORM INSTRUCTIONS

Follow these guidelines for delivery entries on the Offload Form:

- You must make an entry for every groundfish and halibut delivery made to the plant.

An entry must be made for every day you are assigned to the plant. For days with no deliveries, write in a zero for delivery number, note “no deliveries”, and whether or not they were still processing groundfish. These notes are required by NMFS to verify coverage days. Do not sample exempted/experimental fishing permits and do not include them on your Plant/Vessel Offload Form.

Submitting Data

Observers at plants must transmit their data daily.



You must maintain and bring back paper copies of the Plant/Vessel Offload Form, regardless whether or not the plant is equipped with ATLAS!

Cruise, Plant Permit, Year: Your cruise number will be given to you during training or briefing, or by your employer. The plant permit numbers are listed on page A-31. For “Year” you can enter the full year or just the last two digits (e.g., “18”). If data on the Offload Form straddles the end of one year and beginning of the next, a new form should be used to capture the completion date information.

Vessels Only Tab

These fields are only completed by vessel observers. Leave these fields blank.

- **Observer Name/Plant Name:** Enter your name and the name of the plant.
- **Offload Trips:** This field is completed by vessel observers only.

Plants Only Tab

- **Catcher Boat Name:** Enter the name of each catcher boat delivering to your plant. You only need to list each boat once per data set, and the vessel does not have to

be listed at the top of the page where its deliveries are listed. When all the lines on the first page are used up, go on to page 2, etc. Keep the catcher boat list together on the first several pages of your Plant/Vessel Offload Forms.

- **Catcher Boat ADF&G #:** You can find this written in one foot high numbers on both sides of the wheelhouse of each delivering vessel. It is also recorded in the vessel and plant logbooks and on the fish ticket.
- **Vessel Permit #:** Record the vessel permit number. Permit numbers are listed on page A-31 and/or in the ATLAS program on partial coverage vessels. If the vessel does not have a listed permit number, leave this entry blank. Contact the Observer Program to provide you with a vessel permit number.

Offload Number: These must be listed in order by completion date with only one line of data for each delivery. Try to list the offload numbers sequentially but offload numbers can be out of order due to the sequence of how boats are offloaded. Do not split delivery data due to fishing in two NMFS areas. The “Offload Number” on the Length and Specimen Form must correspond to the offload number on the Plant/Vessel Offload Form. Plant observers must enter “0” for any days that no deliveries occurred.

Completion Date: Enter the date of completion of each delivery to the processing plant. Offloads completed on the same day must be grouped together on the Plant/Vessel Offload Form. If the delivery continues over two or more days, use the date when the delivery is complete. Dates must be in two digit format (e.g., MM/DD). Completion date does not need to match the date landed on the fish ticket.

Plants Only Tab

- **Gear Type:** Enter the appropriate code from the list below. If the delivering vessel is acting as a tender, enter the predominant gear type that you believe was used for fishing.

1- Non- pelagic trawl

2- Pelagic trawl

3- Mixed trawl

4- Pair trawl

5- Shrimp trawl

6- Pot or trap

7- Jig

8- Longline

9- Gill net

10- Scottish Seine

- **NMFS Area:** This is the three digit code for the area in which the delivering vessel fished. If the vessel fished in two or more areas for the delivered catch, record the area in which most of the fish were caught. Do not divide delivery data by area. NMFS area can be found on the fish ticket. Leave this field blank for tender offloads.

Total Delivered, Kg or Lb: Record the total round weight delivered to the plant for that trip. This is reported on the fish ticket under **Observer Only** in the “*Total Round Weight*” field. Delivery weights must be reported in pounds or kilograms and recorded to the nearest whole number. Include the fish ticket with the final data turned in to the Observer Program.

If there are multiple fish tickets with the same Landing Report ID Number, sum the individual delivery weights to obtain a single total delivery weight.

Plants Only Tab

- **Total Pollock Weight:** Complete this column for Bering Sea pollock deliveries only. Gear code must be “2” and all pollock must be from the Bering Sea. Record the total weight of all pollock in that delivery.
- **Were All Groundfish Weighed?:** Enter “Y” (Yes), “N” (No), or “U” (Unknown) to indicate if all groundfish *delivered* to the plant were actually weighed. If you enter “N” or “U” you must note in your logbook why all fish were not weighed, or why you are unsure.
- **ADF&G # of Delivering Vessel:** Record the ADF&G number of the delivering catcher vessel. This number should correspond to the vessel name recorded in the “Plants Only” tab on the top of your first few Plant/

SHORESIDE PLANTS AND FLOATING PROCESSORS: PLANT/VESSEL OFFLOAD FORM INSTRUCTIONS

Vessel Offload Forms. You can find this written in one foot high numbers on both sides of the wheelhouse of each delivering vessel. It is also recorded in the vessel and plant logbooks and on the fish ticket. If you are unable to locate the ADF&G number, contact NMFS staff.

Receiving Processor Permit #: This field is completed by vessel observers only.

Was Catch Sorted?: Enter “Y” if any part of the catch was extensively sorted at sea, or “N” if it was not. If you are unsure whether or not catch was sorted, enter “Y” and document the circumstances in your logbook.

Tender Offload?: Enter “Y” if fish were delivered by a tender and a “N” if they were not. See “Deliveries from Tender Vessels” on page 11-10 for more information on tender deliveries.

Landing Report ID Number: Record the Landing Report ID number associated with the delivery from this vessel. This information is taken directly off the fish ticket. Labeled “Landing Report ID”, the number is listed on the left side of the fish ticket, above where the round weights are listed. Record the Landing Report ID number exactly as it appears on the fish ticket. Single deliveries to the same plant with multiple fish tickets will usually have a single Landing Report ID Number. In this case, there should be a single line of entry for this delivery. Leave this field blank for tender offloads.

Occasionally, there may be more than one Landing Report ID Number for an offload. If this occurs, and the delivery was not from a tender vessel, each landing report must be listed separately on the Offload Form as separate offloads. The offload numbers and total delivery weights will be unique to each Landing Report ID Number.

Plants Only Tab

Elanding Management Program: Record the Management Program number associated with the delivery from the vessel. This information is taken directly off the fish ticket. The code is labeled “Mgmt Pgm” and consists of 2-4 characters. Use the table below to find the lettered code. Enter its corresponding numeric code in the Elanding Management Program column on the Plant/Vessel Offload Form and in ATLAS.

| PGM Code | Form Code | Description |
|-----------|-----------|--|
| A 80 | 1 | Amendment 80 |
| ADAK | 2 | Adak Com. Crab Fishery |
| AFA | 3 | AFA Pollock Program |
| AIF | 4 | Annette Is. Fishery |
| AIP | 5 | Aleutian Is. Pollock |
| CDQ | 6 | Community Devel. Quota |
| CPF | 7 | Comm. Permit Fishery |
| EXP | 8 | Experimental/Exploratory |
| IFQ | 9 | Individual Fishery Quota |
| LE | 10 | Limited Entry |
| OA | 11 | Open Access |
| PCTC | 22 | Pacific Cod Trawl Cooperative |
| RES | 12 | Special Study or Research |
| RP | 13 | Rockfish Program (not entered in ATLAS; leave blank) |
| SMO | 14 | State Managed GF/Other |
| SMPC | 15 | State Managed Pacific Cod |
| SMS | 16 | State Managed Sablefish |
| STB | 17 | Salmon Troll Bycatch |
| TEST | 18 | Long Term Stock Assessment |
| (No code) | 19 | Mixed CDQ - AFA |
| (No code) | 20 | Mixed Other |
| (No code) | 21 | Other |

CDQ No.: If the Elanding Management Program code is CDQ, enter the appropriate CDQ number in this column. The CDQ number can be found on the fish ticket directly below the Elanding Management Program code or in the following table. Leave this field empty for all other management codes.

| CDQ No. | Group Description |
|---------|----------------------------------|
| C99 | Other unidentified Fishing Group |
| C51 | Aleutian Pribilof Island |
| C52 | Bristol Bay Economic Corp. |
| C53 | Central BS Fisherman’s Assoc. |
| C54 | Coastal Villages Fishing Coop. |
| C55 | Norton Sound |
| C56 | Yukon Delta |
| M01 | Makah Tribe Whiting Association |

Use the information below to verify the landing report data

Remember, the delivery weight is in the lower right of the landing report under the “Observer Only” box listed as “Total Round Weight” and includes the whole, or round, weight of all delivered species with appropriate PRRs already applied.

- A. Fish tickets only contain accurate information on the catch delivered. The condition code “98” indicates an estimate of catch discarded at sea and should not be included in your delivery weights. Weights from fish retained for bait at sea or on board use affect the weights at the bottom of the fish ticket. **Product codes 92, 95, and 97** are usually not delivered fish, but you must verify this with the plant’s office personnel, delivering vessel, or vessel observer. Plants are not consistent with the use of these codes and fish may have actually been offloaded and then returned to the vessel.
- B. The amount shown in the “Total” field of the fish ticket is weight of fish sold. This is often not the delivery. If a partial delivery took place a box in the partial delivery box on the fish ticket should be checked. The other fish ticket associated with this offload will be listed on the bottom of the ticket once that offload is completed.
- C. Fish tickets may contain only numbers of the prohibited species delivered. If the fish ticket does include a prohibited species weight include this value for the total delivery weight.
- D. Completion of fish tickets is often delayed. Coordinate with vessel observers to ensure that they get the delivery weights when the fish ticket is finalized. This may be during their next offload, or it may require you to fax the information to an Observer Program office.
- E. Condition/Delivery codes - Round weights of fish are needed for delivery weight calculations. Look at the condition codes for the fish weights listed in the main body of the fish ticket. If the code listed is not a “1”, a PRR will have been applied and the round weight added to the “Total Round Weight” and the weight listed at the bottom of the landing report.
- F. Weights listed below the Permit Holder’s Signature are referred to as the “Notes Section” of the fish ticket. The total round weight by species are listed as “delivered” and “discarded” in the Notes Section. Single entries of the total round weight by species will be listed in the Notes Section. Fish with a delivery condition code other than “01” will be listed in the Notes Section with calculated Product Recovery Rates (PRR). Occasionally a plant may exclude certain species from the bottom of the fish ticket. Be sure to compare species listed in the notes at the bottom with the main body of the fish ticket. ***The round weight to at-sea discards (code 98) is not to be included in the delivery weight. See “Product Recovery Rates (PRR)” on page A-22 for instructions on using PRR to calculate round weights.***
- G. Halibut round and net weight are listed in the Notes Section. The net weight is the processed weight of halibut and is already included in the round weight listed.
- H. Some of the weights listed may not be correct. Fish of no value to the plant may have weight estimates rather than scale weights. Check for this and make a note on the fish ticket indicating the estimated weights.
- I. The bycatch species listing is sometimes incorrect. Bycatch species may all be lumped together or mis-sorted. You must check that the weight for total bycatch was recorded properly somewhere, even if it was combined under one species listing and one weight. Document what you see and if you believe extensive or intentional mis-sorting occurred. If the delivery is AFA or CDQ please see page 11-11.
- J. Deductions such as water, rocks, ice, or slime may appear on the fish ticket. If you do not feel these deductions are representative of the offload, document your observation and notify NMFS staff at the earliest opportunity. Ice and slime deductions may be noted on the ticket with “I/S” next to the whole weight. This denotes a deduction of 2% from the scale weight. If you feel the deduction is not necessary, add the deducted amount back in as target weight, include it in the total delivery weight, and document the reasons in your logbook.
- K. Species may be missing from the fish ticket. Some plants do not record other “non-allocated species” weights (such as jellyfish, lancet fish, or Pacific flatnose). Processing plants are not required to record these weights. If the delivery is AFA or CDQ please see page 11-11.

Figure 11-2: ADF&G Electronic Groundfish Ticket Instructions

SHORESIDE PLANTS AND FLOATING PROCESSORS: PLANT/VESSEL OFFLOAD FORM INSTRUCTIONS

If boxes are checked, other fish tickets may be associated

**ALASKA DEPARTMENT OF FISH & GAME
ELECTRONIC GROUND FISH TICKET**

DO NOT WRITE IN THIS SPACE

IXX 009999

| Statistical Area WorkSheet | | | |
|----------------------------|-----|------------|---|
| Stat. Area | % | Stat. Area | % |
| 655600 FED 517 | 100 | | |

| | | |
|---|--|--|
| <p>Vessel ARCTIC STAR</p> <p>ADF&G NO. 99999</p> <p>Permit Owner Permit #### Owner Permit Name</p> <p><input type="checkbox"/> Mag Stripe Read</p> <p>Owner: F9999 Dutch Harbor</p> <p>Custom Processor:</p> | <p>Crew Size 4 Mgmt Pgm AFA</p> <p>Observers onboard 1 ID 111</p> <p>Date Fishing Began (Gear in Water) 02/26/2023</p> <p>Days Fished</p> <p>Date Landed 02/29/2023</p> <p>Time of Landing 12:00</p> | <p>Port of Landing or off-shore operation type</p> <p>DUT Dutch Harbor/Unalaska</p> <p>Type of Gear used</p> <p>47 Pelagic/mid-water trawl</p> |
|---|--|--|

| | |
|--|--|
| | <p>PARTIAL DELIVERY:</p> <p><input type="checkbox"/> Partial Delivery</p> <p><input type="checkbox"/> Dock Delivery</p> <p><input checked="" type="checkbox"/> Last Landing for Trip</p> <p><input type="checkbox"/> Multiple IFQ Permits</p> |
|--|--|

| SPECIES | STAT AREA | DEL. COND | SCALE WEIGHT | NUM | DISP. | SIZE & GRADE | SOLD WEIGHT | PRICE | AMOUNT |
|---------------------|-----------|-----------|--------------|-----|--------------|--------------|-------------|-------|--------|
| 110 P. cod | | 01 Whole | 270 | | 41 Fish meal | | | | |
| 110 P. cod | | 01 Whole | 6,532 | | 60 Sold | | 6532 | | |
| 121 Arrow fldr | | 01 Whole | 15 | | 41 Fish meal | | | | |
| 122 Flathead sole | | 01 Whole | 1,536 | | 41 Fish meal | | | | |
| 123 Rock sole | | 01 Whole | 653 | | 41 Fish meal | | | | |
| 160 Sculpin | | 01 Whole | 54 | | 41 Fish meal | | | | |
| 216 Lump sucker | | 01 Whole | 37 | | 41 Fish meal | | | | |
| 270 Pollock | | 01 Whole | 78,992 | | 41 Fish meal | | | | |
| 270 Pollock | | 01 Whole | 633,951 | | 60 Sold | | 633,951 | | |
| 410 Chinook | | 01 Whole | 21 | 2 | 86 Donated | | | | |
| 700 Skate | | 01 Whole | 59 | | 41 Fish meal | | | | |
| 870 Octopus | | 01 Whole | 27 | | 41 Fish meal | | | | |
| Discards | | | | | | | | | |
| 200 Halibut | | 01 Whole | 19 | 1 | 99 Disc dock | | | | |
| 235 Herring bycatch | | 01 Whole | 57 | | 99 Disc dock | | | | |
| 625 Jellyfish | | 01 Whole | 783 | | 99 Disc dock | | | | |
| Total: | | | | | | | 640,483 | | |

I HEREBY ATTEST THAT THESE FISH WERE CAUGHT IN COMPLIANCE WITH ADF&G REGULATIONS.

Permit Holder's Signature _____

Fish Received by _____ Date _____

Landing Report ID: 1234567 CFEC Serial Number: 654321

| | |
|---|---|
| <p>P. cod Round Weight: 6,802</p> <p>Arrow fldr Round Weight: 15</p> <p>Flathead sole Round Weight: 1,536</p> <p>Rock sole Round Weight: 653</p> <p>Sculpin Round Weight: 54</p> <p>Halibut Round Weight: 19</p> <p>Halibut Net Weight: 14.25</p> <p>Herring bycatch Round Weight: 57</p> <p>Chinook Donated Round Weight: 21</p> <p>Skate Round Weight: 59</p> | <p>Lump sucker Round Weight: 37</p> <p>Pollock Round Weight: 712,943</p> <p>Jellyfish Round Weight: 783</p> <p>Octopus Round Weight: 27</p> |
|---|---|

| Observer only | |
|-----------------------------|--|
| Total Round Weight: 723,006 | |
| ADFG only | |
| Logbook | |
| Observer | |
| Interview | |

Use the "round weight" of halibut. Do not use the "net weight" as it is already included in the round weight.

Look for product codes 92, 95, and 97 as these are not automatically included in the "Total Round Weight" listed in the "Observer Only" box, and they may need to be included.

Code 99 is delivered to the plant so it is included in the delivery weight.

Figure 11-3: ADF&G Electronic Groundfish Ticket (examples)

SHORESIDE PLANTS AND FLOATING PROCESSORS: PLANT/VESSEL OFFLOAD FORM INSTRUCTIONS

Pay close attention to the disposition codes. They will determine if the weights should be included in the total delivery weight.

ALASKA DEPARTMENT OF FISH & GAME
ELECTRONIC GROUND FISH TICKET

DO NOT WRITE IN THIS SPACE

EXX 007777

| Statistical Area WorkSheet | | | |
|----------------------------|-----|------------|---|
| Stat. Area | % | Stat. Area | % |
| 655600 FBD 517 | 100 | | |

Vessel DUTCH LADY
ADF&G NO. 33333
Permit Owner Permit #####
Permit Owner Name

Crew Size 6 **Mgmt Pgm** OA
Observers onboard 1 **ID**

Port of Landing or off-shore operation type
 DUT Dutch Harbor/Unalaska
Type of Gear used
 91 Pot

✓ *Mag Stripe Read*

Owner: F9999 Dutch Plant
Custom Processor:

Date Fishing Began (Gear in Water) 01/02/2023
Days Fished 3
Date Landed 01/06/2023
Time of Landing 12:00

PARTIAL DELIVERY:
 Partial Delivery
 Dock Delivery
 Last Landing for Trip
 Multiple IFQ Permits

| SPECIES | STAT AREA | DEL. COND | SCALE WEIGHT | NUM | DISP. | SIZE & GRADE | SOLD WEIGHT | PRICE | AMOUNT |
|---|-----------|-----------|--------------|-----|---------------|--------------|-------------|-------|--------|
| 110 P. cod | | 03 Bled | 173,005 | 60 | Sold | 23" Over | 146,052 | | |
| 110 P. cod | | 03 Bled | 1,289 | 41 | Fish meal | 23" Under | 26,953 | | |
| 270 Pollock | | 01 Whole | 1,540 | 41 | Fish meal | | | | |
| Not Sold - Retained for Bait - Personal Use | | | | | | | | | |
| 870 Octopus | | 01 Whole | 756 | | 92 Rtn'd bait | | | | |
| 870 P. cod | | 01 Whole | 55 | | 95 Pers use | | | | |
| Discards | | | | | | | | | |
| 160 Sculpin | | 01 Whole | 320 | | 98 Disc atsea | | | | |
| 931 Bairdi | | 01 Whole | | 530 | 98 Disc atsea | | | | |
| 870 Octopus | | 01 Whole | 140 | | 98 Disc atsea | | | | |

Delivery condition "03-Bled" indicates that the fish was not delivered whole. A PRR is applied to calculate the round weight of these fish. The Notes Section contains the round weights of all the fish listed in the Main Body.

Main Body

Total: 175,078

I HEREBY ATTEST THAT THESE FISH WERE CAUGHT IN COMPLIANCE WITH ADF&G REGULATIONS.

Permit Holder's Signature _____

Fish Received by _____ Date _____

| Taxes | Rate | Amount |
|--------------|------|--------|
| Landings Tax | | |
| AFA Fee | | |
| Other | | |
| Total | | |

Landing Report ID: 7654321 CFEC Serial Number: 123456

P. cod Round Weight: 177,906
 Sculpin Discard Round Weight: 320
 Pollock Round Weight: 1540
 Octopus Round Weight: 756
 Octopus Discard Round Weight: 140

Notes Section

Code 98 is never included in the delivery weight.

| Observer only | |
|---------------------|---------|
| Total Round Weight: | 179,391 |
| ADF&G only | |
| Logbook | |
| Observer | |
| Interview | |

In this delivery "92-Rtn'd bait" octopus will be included in the total delivery weight because the observer verified that they were delivered and weighed by the plant, then returned to the vessel. The "95-Pers use" P. Cod will not be included in the total delivery weight because it was not delivered or weighed by the plant and verified by the observer. The weight listed in the ticket is an estimate reported to the plant by the captain.

Code 92 and code 95 are not included in the "Observer Only" total round weight. To calculate Total Delivery Weight for this offload, you need to add the weight of the delivered octopus (code 92) to the Observer Only Weight.

179391 lbs + 756 lbs

Total Delivery weight = 180147 lbs.

Figure 11-4: ADF&G Electronic Groundfish Ticket (examples)

SHORESIDE PLANTS AND FLOATING PROCESSORS: PLANT/VESSEL OFFLOAD FORM INSTRUCTIONS

Page 1 of 1

| | | | |
|------------------------|-----------------------|---------------------|----------------------------------|
| Cruise <u>20720</u> | Permit <u>6789</u> | Year <u>2023</u> | Plant/Vessel Offload Form |
|------------------------|-----------------------|---------------------|----------------------------------|

| | |
|----------------|----------------------|
| Vessels Only | |
| Processor Name | Processor Permit No. |
| | |
| | |

Observer Name Jackie Mackrelli

Vessel/Plant Name Pelican Sflds.

| | | |
|--------------------|------------------------|-------------------|
| Plants Only | | |
| Catcher Boat Name | Catcher Boat ADF&G No. | Vessel Permit No. |
| <u>Pam fret</u> | <u>10981</u> | <u>2223</u> |
| <u>Little Lucy</u> | <u>76542</u> | <u>6765</u> |
| <u>Rosieleen</u> | <u>32103</u> | <u>5555</u> |
| <u>Roman James</u> | <u>20194</u> | <u>7767</u> |

Resubmission (Circle All Changes)

| Offload Trip(s) Vessels Only | Offload No. | Completion Date | | Plants only | | Total Delivered | Kg or Lb | Plants only | | Receiving Processor Permit No. Vessels Only | Was Catch Sontag? (Y/N) | Transfer Offload? (Y/N) | Landing Report ID No. | Plants only | |
|---------------------------------|-------------|-----------------|-----|-------------|-----------|-----------------------------|----------|---|------------------------------------|--|-------------------------|-------------------------|-----------------------|--------------------------------|---------------------------|
| | | Month | Day | Gear Type | NMFS Area | | | Total Pollock Weight BSAI Pollock Only | Were All Groundlin Weighers? (Y/N) | | | | | ADF&G No. of Delivering Vessel | Ending Management Program |
| | 0 | 08 | 31 | | | No Deliveries | | | | | | | | | |
| | 0 | 09 | 01 | | | No Deliveries | | | | | | | | | |
| | 1 | 09 | 02 | 2 | 517 | 187297 LB | 180111 | Y | 10981 | | N | N | 200880 | 3 | |
| | 2 | 09 | 03 | 8 | 517 | 6534 LB | | Y | 20194 | | Y | N | 200881 | 9 | |
| | 3 | 09 | 04 | 2 | 517 | 205639 LB | 197266 | N | 10981 | | N | N | 200905 | 3 | |
| | 4 | 09 | 04 | 2 | 517 | 250420 LB | 249325 | Y | 32103 | | N | N | 200922 | 3 | |
| | 5 | 09 | 04 | 8 | 521 | 849 LB | | Y | 20194 | | Y | N | 200923 | 11 | |
| | 6 | 09 | 05 | 2 | 517 | 166239 LB | 165200 | Y | 10981 | | N | N | 200940 | 3 | |
| | 7 | 09 | 05 | 1 | | 343196 LB | | Y | 76542 | | N | Y | | 11 | |
| | 8 | 09 | 06 | 2 | 517 | 21322 LB | 211311 | Y | 32103 | | N | N | 200967 | 3 | |
| | 0 | 09 | 07 | | | No Deliveries | | | | | | | | | |
| | 9 | 09 | 08 | 2 | 610 | 32752 LB | | Y | 76542 | | N | N | 200991 | 11 | |
| | 10 | 09 | 08 | 8 | 610 | 14318 LB | | Y | 00882 | | Y | N | 201002 | 6 C56 | |
| | 0 | 09 | 09 | | | No Deliveries | | | | | | | | | |
| | 0 | 09 | 10 | | | No Deliveries - Disembarked | | | | | | | | | |

Notes: Offload #3 - Plant scale malfunctioned - Plant estimated ~20000 lbs not weighed and added weight to fish ticket.

National Marine Fisheries Service/Fisheries Monitoring and Analysis Division Page _____ of _____ for Transmission Ver. 2014

Figure 11-5: Plant/Vessel Offload Form Data by Plant Observer Example

| DECK FORM | | | | | Page <u>16</u> of _____ for Vessel/Plant | |
|--|-------------------------------------|--------------------------------|----------|-------------------------------------|---|---|
| Date | Cruise | Permit | Haul No. | Offload No. | Page <u>1</u> of <u>1</u> for Haul/Offload | |
| 01/29/23 | 14533 | 5323 | | 25 | | |
| Sample #: | | Sub-Sample #: | | Sample Size: | Kgs Segments pots | # of Sampled Hooks: |
| Presorted <input type="radio"/> | | Combined <input type="radio"/> | | Last Chinook-9 Last Chum-19 | | No Fish in Sample <input type="radio"/> |
| Species | Sex | # | Weight | % ret. | Length, viability, injury, specimen, tally data, measurements, bird observations, sample design, notes: | |
| ----- KEYPUNCH ----- | <input checked="" type="checkbox"/> | | | <input checked="" type="checkbox"/> | Vessel: AK Dream Observer: Matthias Jabs Breaks: 0200-0430 0700-0930 1200-1430 Deckload: YES ~ 20000 LB Pre-Offload meeting @ 0300 Offload start: 01/29 @ 0100 End: 01/29 @ 1700 | |
| Genetics/FMA ID | | | | | | |
| sp# 9-Chinook/M/45/1.70/Adipose present | | | | | | |
| All scales: Zone B/C | | | | | | |
| sp# 10-Chinook/F/75/5.70/Adipose present | | | | | | |
| All scales: Zone C | | | | | | |
| sp# 11-Chum/M/65/4.20/Adipose present | | | | | | |
| Genetics: Zone A FMA ID-Zone B | | | | | | |
| FMA ID | | | | | | |
| - sp# 12-Coho/F/52/3.80/Adipose Present/Zone A | | | | | | |
| - sp# 13-Salmon Unident/M/48/2.30 | | | | | Saved fish (bagged & tagged) KM | |
| Adipose present/Zone C | | | | | | |
| Sample #: | | Sub-Sample #: | | Sample Size: | Kgs Segments pots | # of Sampled Hooks: |
| Presorted <input type="radio"/> | | Combined <input type="radio"/> | | | | No Fish in Sample <input type="radio"/> |
| Species | Sex | # | Weight | % ret. | Length, viability, injury, specimen, tally data, measurements, bird observations, sample design, notes: | |
| ----- KEYPUNCH ----- | <input checked="" type="checkbox"/> | | | <input checked="" type="checkbox"/> | Salmon Retention Count on 01/29 by David G & KM @ 1705 (plant) Chinook- <input checked="" type="checkbox"/> <input checked="" type="checkbox"/> <input checked="" type="checkbox"/> <input checked="" type="checkbox"/> (13) chum- <input checked="" type="checkbox"/> <input checked="" type="checkbox"/> <input checked="" type="checkbox"/> <input checked="" type="checkbox"/> (18) 18 Coho- 1 (1) Salmon Unident 1 (1) Sockeye-0 Pink-0 End offload Genetics: - Last Chinook: 2 (next 8) - Last Chum: 7 (next 23) | |
| | | | | | | |
| | | | | | | |
| | | | | | | |
| | | | | | | |
| | | | | | | |
| | | | | | | |
| | | | | | | |
| | | | | | | |
| | | | | | | |
| Sample #: | | Sub-Sample #: | | Sample Size: | Kgs Segments pots | # of Sampled Hooks: |
| Presorted <input type="radio"/> | | Combined <input type="radio"/> | | | | No Fish in Sample <input type="radio"/> |
| Species | Sex | # | Weight | % ret. | Length, viability, injury, specimen, tally data, measurements, bird observations, sample design, notes: | |
| ----- KEYPUNCH ----- | <input checked="" type="checkbox"/> | | | <input checked="" type="checkbox"/> | After each salmon count, document when the next king/chum salmon will be selected for genetics from the next pollock delivery. The observer recorded the last king and chum salmon counted for this offload based on a 10 and 30 tally respectively. The next genetic sample will be collected from the 8th king and the 23rd chum encountered in the next pollock offload. | |
| | | | | | | |
| | | | | | | |
| | | | | | | |
| | | | | | | |
| | | | | | | |
| | | | | | | |
| | | | | | | |
| | | | | | | |
| | | | | | | |

Del-24 Last sp# 8

Figure 11-6 Plant Deck Form Raw Data Example of Bering Sea Pollock Delivery(1 of 3)

DECK FORM

| | | | | | |
|----------|--------|--------|----------|-------------|--|
| Date | Cruise | Permit | Haul No. | Offload No. | Page <u>17</u> of _____ for Vessel/Plant |
| 01/31/23 | 14533 | 5323 | | 26 | Page <u>1</u> of <u>1</u> for Haul/Offload |

| | | | | |
|---------------------------------|--------------------------------|----------------------------|-------------------------|---|
| Sample #: | Sub-Sample #: | Sample Size: | Kgs Segments pots | # of Sampled Hooks: |
| Presorted <input type="radio"/> | Combined <input type="radio"/> | Last Chinook-2 Last Chum-7 | | No Fish in Sample <input type="radio"/> |

| Species | Sex | # | Weight | % ret. | Length, viability, injury, specimen, tally data, measurements, bird observations, sample design, notes |
|---|-----|---|--------|--------|---|
| ----- KEYPUNCH ----- | X | | | X | |
| <u>Genetics/FMA ID</u> | | | | | Vessel: Sea Eagle Observer: Syd Barrett Breaks: 0200-0500 0800-1100 NO Deckload Offload Start: 01/30 @ 2330 End: 01/31 @ 1450 |
| sp#14-Chinook/M/56/2.30/Adipose present | | | | | |
| All scales Zone A | | | | | |
| sp#15-Chinook/M/53/2.10/Adipose present | | | | | |
| All scales Zone A/B | | | | | |
| sp#16-Chinook/F/65/3.50/Adipose present | | | | | |
| NO scales! | | | | | |
| sp#17-Chinook/F/67/3.90/Adipose present | | | | | |
| Genetics-Zone B FMA ID-Zone C | | | | | |
| sp#18-Chinook/F/68/3.80/Adipose absent | | | | | |
| All Scales-Zone B snout collected | | | | | |

Tally K/P KM

| | | | | |
|---------------------------------|--------------------------------|--------------|-------------------------|---|
| Sample #: | Sub-Sample #: | Sample Size: | Kgs Segments pots | # of Sampled Hooks: |
| Presorted <input type="radio"/> | Combined <input type="radio"/> | | | No Fish in Sample <input type="radio"/> |

| Species | Sex | # | Weight | % ret. | Length, viability, injury, specimen, tally data, measurements, bird observations, sample design, notes |
|--|-----|---|--------|--------|---|
| ----- KEYPUNCH ----- | X | | | X | |
| Expecting a high count for King salmon in this offload, the observer used a thumb counter to tally these species | | | | | <u>Salmon Retention Count on 01/31</u> by Roger W & KM KM @ 1450 r (plant) Chinook- (57) Coho-0 Chum- 14 (8) Sockeye -0 Pink-0 End offload Genetics: Last Chinook- 9 (next 1) Last Chum- 15 (next 15) |
| | | | | | |
| | | | | | |
| | | | | | |
| | | | | | |
| | | | | | |
| | | | | | |
| | | | | | |
| | | | | | |
| | | | | | |

Tally K/P

Figure 11-7: Plant Deck Form Raw Data Example of Bering Sea Pollock Delivery (2 of 3)

SHORESIDE PLANTS AND FLOATING PROCESSORS: PLANT/VESSEL OFFLOAD FORM INSTRUCTIONS

RP DECK FORM

| | | | | | |
|----------|--------|--------|----------|-------------|--|
| Date | Cruise | Permit | Haul No. | Offload No. | Page <u>18</u> of _____ for Vessel/Plant |
| 02/01/23 | 14533 | 5323 | | 27 | Page <u>1</u> of <u>1</u> for Haul/Offload |

| | | | | |
|---------------------------------|--------------------------------|--------------|-------------------------|---|
| Sample #: | Sub-Sample #: | Sample Size: | Kgs Segments pots | # of Sampled Hooks: |
| Presorted <input type="radio"/> | Combined <input type="radio"/> | | | No Fish in Sample <input type="radio"/> |

| Species | Sex | # | Weight | % ret. | Length, viability, injury, specimen, tally data, measurements, bird observations, sample design, notes: | | | | | | | | | | | | | | | | | | | | | | | | | | | | | | | | | | | | | | | | | | | | | | | | | | | | | | | |
|----------------------|--------|----------------------|--------|------------------|--|---|---|-----|------|----------|--------|------|--------|----|------------------|------|------|----------------------|--|--|------|------|--------|----|------------------|------|--------|----------|--|--|--------|------|--------|----|------------------|------|------|----------|--|--|--------|--------|--------|----|------------------|--|--|--------------------|--|--|--|--|--------|----|------------------|--|--|----------|--|--|
| ----- KEYPUNCH ----- | X | | | X | <p>Vessel: Starchaser PCod (Bled) Round Wt. = x/.98</p> <table border="1" style="width: 100%; border-collapse: collapse;"> <thead> <tr> <th style="width: 10%;">M</th> <th style="width: 10%;">F</th> <th style="width: 10%;">sp#</th> <th style="width: 10%;">PCod</th> <th style="width: 10%;">Otoliths</th> </tr> </thead> <tbody> <tr> <td style="text-align: center;">(33)-1</td> <td style="text-align: center;">56-1</td> <td>19 - F</td> <td>86</td> <td>@ 8.47 (8.3/.98)</td> </tr> <tr> <td style="text-align: center;">55-1</td> <td style="text-align: center;">62-1</td> <td colspan="3"># 388651 - Pre-spawn</td> </tr> <tr> <td style="text-align: center;">56-L</td> <td style="text-align: center;">64-L</td> <td>20 - M</td> <td>74</td> <td>@ 6.43 (6.3/.98)</td> </tr> <tr> <td style="text-align: center;">57-L</td> <td style="text-align: center;">(66)-1</td> <td colspan="3"># 388652</td> </tr> <tr> <td style="text-align: center;">(68)-1</td> <td style="text-align: center;">69-L</td> <td>21 - M</td> <td>68</td> <td>@ 4.29 (4.2/.98)</td> </tr> <tr> <td style="text-align: center;">72-1</td> <td style="text-align: center;">75-1</td> <td colspan="3"># 388654</td> </tr> <tr> <td style="text-align: center;">(74)-1</td> <td style="text-align: center;">(86)-1</td> <td>22 - F</td> <td>66</td> <td>@ 6.33 (6.2/.98)</td> </tr> <tr> <td></td> <td></td> <td colspan="3"># 388655 Pre-spawn</td> </tr> <tr> <td></td> <td></td> <td>23 - M</td> <td>33</td> <td>@ 1.22 (1.2/.98)</td> </tr> <tr> <td></td> <td></td> <td colspan="3"># 388656</td> </tr> </tbody> </table> | M | F | sp# | PCod | Otoliths | (33)-1 | 56-1 | 19 - F | 86 | @ 8.47 (8.3/.98) | 55-1 | 62-1 | # 388651 - Pre-spawn | | | 56-L | 64-L | 20 - M | 74 | @ 6.43 (6.3/.98) | 57-L | (66)-1 | # 388652 | | | (68)-1 | 69-L | 21 - M | 68 | @ 4.29 (4.2/.98) | 72-1 | 75-1 | # 388654 | | | (74)-1 | (86)-1 | 22 - F | 66 | @ 6.33 (6.2/.98) | | | # 388655 Pre-spawn | | | | | 23 - M | 33 | @ 1.22 (1.2/.98) | | | # 388656 | | |
| M | F | sp# | PCod | Otoliths | | | | | | | | | | | | | | | | | | | | | | | | | | | | | | | | | | | | | | | | | | | | | | | | | | | | | | | | |
| (33)-1 | 56-1 | 19 - F | 86 | @ 8.47 (8.3/.98) | | | | | | | | | | | | | | | | | | | | | | | | | | | | | | | | | | | | | | | | | | | | | | | | | | | | | | | | |
| 55-1 | 62-1 | # 388651 - Pre-spawn | | | | | | | | | | | | | | | | | | | | | | | | | | | | | | | | | | | | | | | | | | | | | | | | | | | | | | | | | | |
| 56-L | 64-L | 20 - M | 74 | @ 6.43 (6.3/.98) | | | | | | | | | | | | | | | | | | | | | | | | | | | | | | | | | | | | | | | | | | | | | | | | | | | | | | | | |
| 57-L | (66)-1 | # 388652 | | | | | | | | | | | | | | | | | | | | | | | | | | | | | | | | | | | | | | | | | | | | | | | | | | | | | | | | | | |
| (68)-1 | 69-L | 21 - M | 68 | @ 4.29 (4.2/.98) | | | | | | | | | | | | | | | | | | | | | | | | | | | | | | | | | | | | | | | | | | | | | | | | | | | | | | | | |
| 72-1 | 75-1 | # 388654 | | | | | | | | | | | | | | | | | | | | | | | | | | | | | | | | | | | | | | | | | | | | | | | | | | | | | | | | | | |
| (74)-1 | (86)-1 | 22 - F | 66 | @ 6.33 (6.2/.98) | | | | | | | | | | | | | | | | | | | | | | | | | | | | | | | | | | | | | | | | | | | | | | | | | | | | | | | | |
| | | # 388655 Pre-spawn | | | | | | | | | | | | | | | | | | | | | | | | | | | | | | | | | | | | | | | | | | | | | | | | | | | | | | | | | | |
| | | 23 - M | 33 | @ 1.22 (1.2/.98) | | | | | | | | | | | | | | | | | | | | | | | | | | | | | | | | | | | | | | | | | | | | | | | | | | | | | | | | |
| | | # 388656 | | | | | | | | | | | | | | | | | | | | | | | | | | | | | | | | | | | | | | | | | | | | | | | | | | | | | | | | | | |

If fish are delivered that have been bled or cleaned you must use the appropriate PRR to calculate the whole weight (round weight) for your specimen data.

| | | | | |
|---------------------------------|--------------------------------|--------------|-------------------------|---|
| Sample #: | Sub-Sample #: | Sample Size: | Kgs Segments pots | # of Sampled Hooks: |
| Presorted <input type="radio"/> | Combined <input type="radio"/> | | | No Fish in Sample <input type="radio"/> |

| Species | Sex | # | Weight | % ret. | Length, viability, injury, specimen, tally data, measurements, bird observations, sample design, notes: |
|----------------------|-----|---|--------|--------|---|
| ----- KEYPUNCH ----- | X | | | X | |

Del 26 Lost sp # 18

Figure 11-8: Plant Deck Form Raw Data Example (3 of 3)

PROHIBITED SPECIES SAMPLING

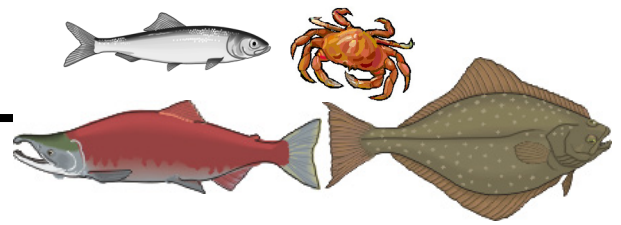

Table of Contents

| | |
|--|-------|
| Priorities | 12-1 |
| Sampling for Lengths and Specimens | 12-2 |
| Herring Data Collection | 12-2 |
| Crab Data Collection | 12-3 |
| Crab in Species Composition Samples | 12-3 |
| Recording Biological Data | 12-3 |
| Measurements, Sex Determination, and Presence of Eggs | 12-3 |
| Measuring Crab in the BSAI Pollock Fishery | 12-4 |
| Sex Determination of Crab and Checking for Eggs | 12-4 |
| Halibut Data Collection | 12-5 |
| Technique for Measuring Halibut | 12-5 |
| Protocols for Halibut Condition Data (Viability) on Trawlers and Pot Vessels | 12-6 |
| Halibut Injury Assessments on Longliners | 12-8 |
| Salmon Data Collection | 12-9 |
| Salmon in Species Composition Samples | 12-9 |
| Salmon Discarded at Sea (Pollock Catchers) | 12-10 |
| Sex/Length Data for Salmon | 12-10 |
| Scale Sample Protocols | 12-11 |
| Salmon Scale Collection Guidelines | 12-11 |
| Recording Specimen Collection Data on the Deck Form and on the Salmon Envelope | 12-12 |
| FMA ID Scale Collection | 12-13 |
| Salmon Genetics Sampling | 12-13 |
| Genetics Sampling Bering Sea Pollock: Random Systematic Collection Protocol | 12-14 |
| Genetics Sampling: GOA Collection Protocol | 12-14 |
| Collection Instructions | 12-14 |
| If You Run Out of Supplies | 12-15 |
| Storage Instructions | 12-15 |
| Salmon Retention Data in the Pollock Fishery | 12-16 |
| AFA Pollock Catcher Processors, Motherships, and Plants | 12-16 |
| Salmon Retention Recording and Reporting Requirements | 12-19 |
| Salmon Retention Form Instructions | 12-19 |

PRIORITIES

- Collect salmon retention data.
- Collect salmon genetics samples.
- Collect salmon scales.
- Count, weigh, and identify all prohibited species in your species composition sample.
- Collect crab measurements from species composition.
- Collect halibut viabilities or injury assessments.

INTRODUCTION

Certain species cannot be retained when fishing in particular fisheries. These species cannot be consumed by

the crew, even if killed by the fishing operations, and must be returned to the sea as soon as possible with minimal injury. These are referred to as “prohibited species.” These species are also managed by other agencies and the data needs differ slightly from other species encountered in the North Pacific fisheries. The prohibited species group includes all Tanner crab species, all king crab species, all salmon species, Pacific Halibut, and Pacific Herring. As fishing seasons and the year progress, other species may become prohibited.

Please refer to “Prohibited Species §679.21” on page 20-14 for additional information regarding prohibited species. In addition to collecting data on the abundance of these species in the composition of commercial catches, observers are asked to collect measurements and other significant biological data from these animals, with the exception of herring.

PROHIBITED SPECIES SAMPLING: SAMPLING FOR LENGTHS AND SPECIMENS

Just as the length measurements on target species help provide information on what populations are being targeted by fishing operations, the measurements of prohibited species provide information as to which parts of the populations of prohibited species are being caught as bycatch. Specimen data for prohibited species are recorded on the Length and Specimen Form in ATLAS. Data collected for prohibited species include:

- Genetics data from Chinook and Chum Salmon.
- Sex, length, weight, and scale data from salmon.
- Length and condition data from halibut.
- Sex and length or width from crab.
- Presence of eggs in female crab.

For instructions on how to complete the Length and Specimen Form, see page 13-16.

Tagged salmon data are recorded on the Bag and Tag Specimen Collection Label (see page 15-3). Tagged prohibited species data are recorded on the paper Tagged Fish Form (see Figure 15-1 on page 15-5).

SAMPLING FOR LENGTHS AND SPECIMENS

Most length and specimen data will be collected from the fish encountered in your randomly collected species composition samples. Some prohibited species data may be collected from outside the composition samples and recorded at the haul level.

All salmon and crab listed on the Length and Specimen Form must be identified to species and sex levels. Biological data from unidentified salmon or crabs are useless to resource managers.

If there are too many king or Tanner crab in a sample for you to sex and measure all individuals, collect a simple random or random systematic subset of about 20 individuals to identify to species, sex, and measure. *These individuals must be randomly selected from unsorted catch.* For example, on a pot vessel a sampled pot has over 100 Tanner crabs. All the crab are placed into a tote. Randomly choose half of the tote for your species identification subset of approximately 50 crab. From these crab, randomly choose ~ 20 crab for sex/length data.

Randomly collect halibut to measure and assess for viability or injury.

Refer to “Collecting Fish for Sex/Length and Specimen Data” on page 13-2 for instructions on how to collect a random or systematic sample.

You must record raw data on your Deck Form to assist yourself and staff if questions arise during your mid-cruise or debriefing interview.

HERRING DATA COLLECTION

Count and weigh all the herring from within your species composition samples. These data are recorded on the deck form along with other data for the sample. Do not measure or determine the sex of herring.



Herring occur most often in the pollock fishery. They can be numerous at times and difficult to sort if samples are large. You must be able to account for all species in a sample. If you are missing herring, you must reduce your sample size unless herring are one of two predominant species. In this case you can sample for two predominant species. See “Subsampling for Two Predominant Species” on page 5-20

CRAB DATA COLLECTION

Complete crab data collection tasks in the following order of priority:



- Count, weigh, and identify every crab in your randomly collected species composition data.
- Measure and determine the sex of all prohibited crab species (Tanner and king crab). The eight species of concern to the North Pacific Fisheries Management Council are: Bairdi Tanner Crab, Opilio Tanner Crab, Angulatus Tanner Crab, Tanneri Tanner Crab, Brown or Golden King Crab, Blue King Crab, Red King Crab, and Couesi King Crab
- For prohibited crab species only, check for the presence of eggs in females.

Look for tagged crabs. Refer to “Tagged Crab” on page 15-3 for information on what types of tags are used and what data to collect.



Do not consume any species of crab that were caught by your vessel or delivered to your plant. The status of non prohib crabs can change to the prohibited status at any time during your contract.

Crab in Species Composition Samples

In your species composition samples, identify all crab to species or species group. For the two prohibited species groups (Tanner and king crab) identify the crabs to species and sex, then record their numbers and weights for the sample on the Deck Form. Fisheries managers manage prohibited crab species by number not weight. If there are too many crab to identify, or too many to weigh or count, refer to appropriate section for your gear type:

- For *trawl* vessel guidelines refer to “Counting and Weighing Prohibited Species Crab and Salmon on Trawlers” on page 5-24.
- For *longline* vessel guidelines refer to “Tallying the Tanner Crab and King Crab Complex” on page 8-14.
- For *pot* vessel guidelines refer to “When You Cannot Count All the Crab in a Pot” on page 10-10.

Recording Biological Data

Separate data records for any crab in your samples by species, sex, presence of eggs (females only), and carapace measurements. *You must record raw data on your Deck Form* to assist yourself and staff if questions arise during your mid-cruise or debriefing interview.

Measurements, Sex Determination, and Presence of Eggs

Biological data such as measurements, sex, and the presence of eggs should be collected from Tanner crab and king crab species within your composition samples.

Measuring Crab

All prohibited crab species must be measured using the calipers provided by the Observer Program. If you do not have calipers, do not attempt to measure crabs. Never use a tape measure or fish length strip for crabs because these are only accurate to the nearest centimeter.

To measure crab, lay the individual on a flat surface facing away from you to avoid the claws. Spread the calipers across the top of the crab and close the caliper arms until the tips are touching the carapace. If the crab

tries to walk away, hold the body down with one hand while you work the calipers with the other hand.

- King crab are measured from the right eye socket to the middle of the *posterior margin of the carapace*. Do not include the second abdominal segment in your measurement. Be careful not to let the caliper tip slip into the eye socket; keep the tip at the socket rim.

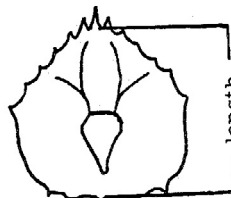

- Tanner crab are measured across the carapace. Measure at the widest part of the carapace on the lower lateral margin, not the branchial ridge.

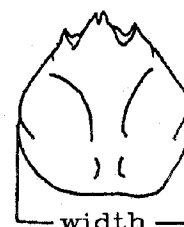
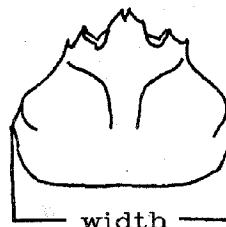
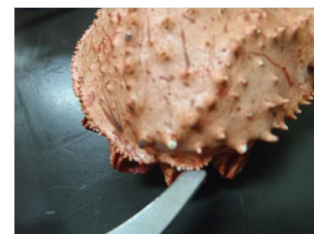
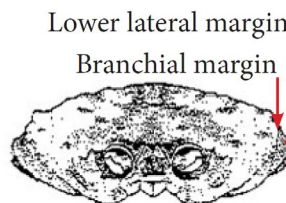

You will be given a Crab Measuring Form to record crab measurements. The form is marked in 5 mm increments starting at 3 mm. Crab lengths read from this sheet will always end in digits 3 or 8. For example, all crabs 41 to 45 mm in size are recorded as 43 mm, crabs 46 to 50 mm are recorded as 48 mm.

Measure the crab and without moving the arms of the calipers, lay the tip of one arm on the ‘start line’ at the bottom of the plastic form. Lay the tip of the other arm perpendicular to the start line. Record the length directly on the Deck Form. If you choose to mark lengths on the crab length strip make a pencil mark within the millimeter range indicated by this tip. Be sure to make

PROHIBITED SPECIES SAMPLING: CRAB DATA COLLECTION

your mark in the appropriate sex category and take great care when transcribing lengths to the Deck Form! If the caliper arm falls directly on a line, report the smaller measurement for this individual. Do not use any other measuring device to determine crab lengths.

Measuring Crab in the BSAI Pollock Fishery

All catcher processor and catcher only vessels participating in the BSAI pollock fishery are required to use pelagic gear. *The presence of 20 or more of any species of crab* indicates the vessel was non-pelagic fishing, or 'fishing the bottom.' When more than 20 crab occur in a pollock haul, observers are asked to do the following: 1) count and measure any crab in the composition samples, regardless of species and 2) begin measuring all the crab you find, if there are more than you can handle, measure as many as you can.

Measure prohibited crab species as described previously. For non prohibited species of crab measure as follows:

- For hermit and sponge crab inside of their shell or sponge, measure the width at the widest point of the shell or sponge. On the Deck Form, make sure to indicate that these measurements were of the shells and not the actual crabs. If you are using ATLAS note this in your logbook.
- All other crabs should be measured across the widest part of the carapace.

The measurements of these crab must be recorded on the right side of your Deck Form and clearly labeled if they were found with in your samples or outside of your species composition. Any lengths from prohibited crab species in your samples must be entered into ATLAS on the Length and Specimen Form. Do not enter any lengths from non prohibited crab species. Do not enter lengths from crab found outside of your samples.

Do not determine the sex of non-prohibited crabs. For specifics on this regulation (see "Crab §679.7" on page 20-14).

Sex Determination of Crab and Checking for Eggs

The shape of the abdominal flap indicates the sex of Tanner and king crab. Refer to Figure 12-1 and Figure 12-2 for images depicting the differences between the abdominal flap shape of mature male and female crab.

- Female king and Tanner crab have an abdominal flap that is rounded at the lower lateral margins. By lifting

the flap slightly, you can determine if females are carrying eggs.

- Male king and Tanner crabs have a V or U-shaped abdominal flap that does not cover the bottom of the carapace. When immature, the abdominal flap is shaped like a finger. When male crabs are mature, the abdominal flap is V-shaped in king crabs and U-shaped in Tanner crabs.

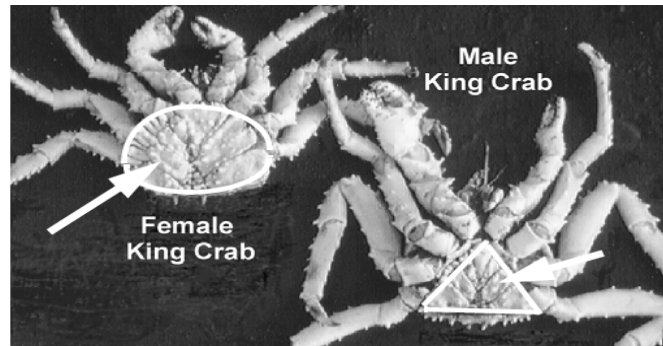
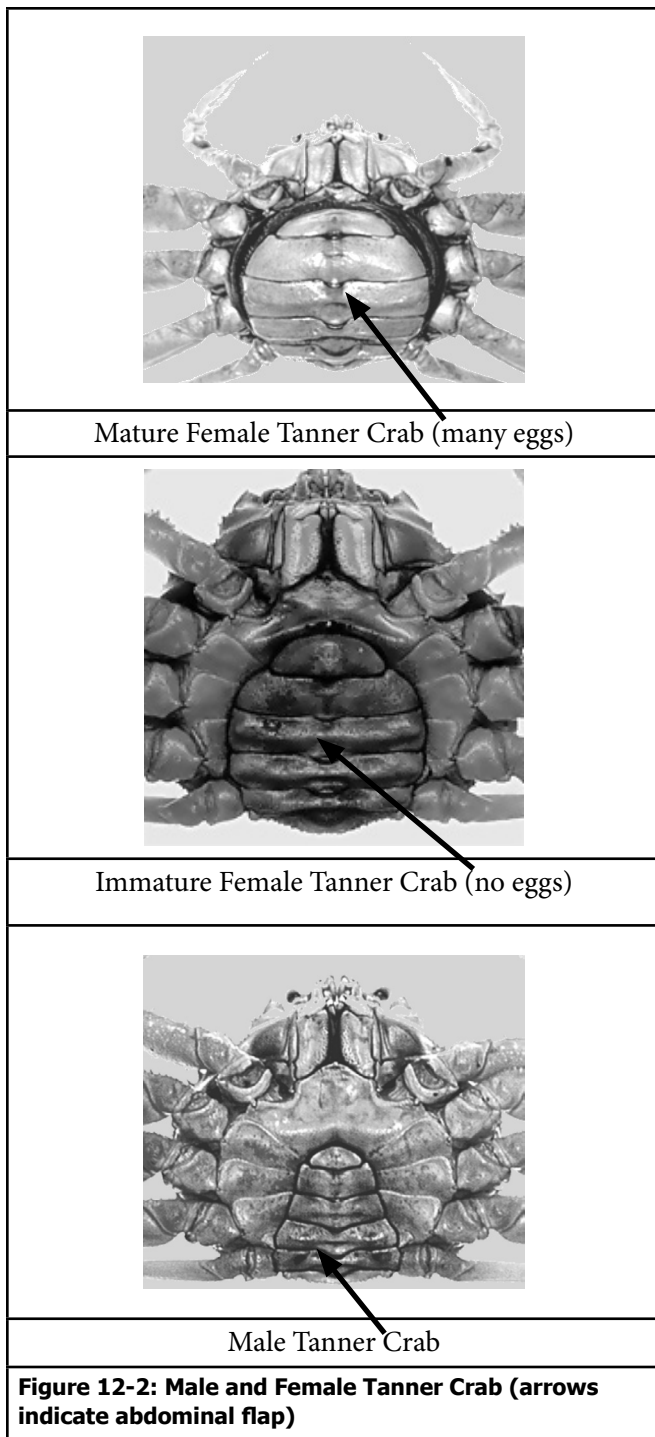

Figure 12-1: Male and female king crab (arrows and lines indicate abdominal flap)



HALIBUT DATA COLLECTION

Data collected on halibut are used to monitor bycatch against the halibut prohibited species catch (PSC) limit. All halibut caught as bycatch in the North Pacific groundfish fisheries must be returned to the sea with minimal injury (this includes non-retained halibut

aboard IFQ vessels). Many of these halibut are released alive and remain a part of the stock. The International Pacific Halibut Commission (IPHC) relies on observer assessments of halibut condition (viability and injury) to estimate the fraction of the released fish that die in order to account for bycatch mortality in the management of the halibut stock. With information on halibut length and condition, the IPHC also monitors trends in halibut size and release condition as they relate to capture, crew handling, and fishing practices.

Complete halibut tasks in the following order of priority:

- Obtain the total number and weight of Pacific Halibut in your composition samples. Observers will never determine the sex of halibut unless a research project directs the observer to do so.
- On non-pollock trawl catcher processor and mothership vessels conducting halibut deck sorting follow halibut data collection protocols outlined in Chapter 5.
- Collect about 10 halibut lengths and viability (trawlers and pot vessels) or injury (longliners) assessments from sampled hauls at the point of discard. If you are unable to collect condition data, record halibut length data with a viability of “U”.

Check for tagged halibut. Refer to “TAGGED FISH AND CRAB” on page 15-1 for information on what sorts of tags are used and what data to collect from tagged fish.

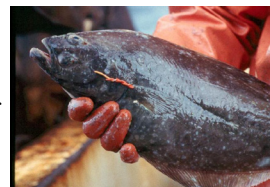

Halibut management and careful release methods for longline vessels are discussed on page 8-20.

Technique for Measuring Halibut

Halibut are measured by fork length; see the definition of fork length in your Species Identification Manual or see page 13-6 of this manual. Lay the halibut on the plastic length strip or on top of a tape measure. *Do not obtain measurements derived from laying the tape measure over the top of the fish and “sighting down.”* These are curvilinear lengths and they are not viable data for data users!

For large halibut, offset your length strip by twenty or more centimeters, or use your measuring tape. If using the measuring tape remember to do the following:

- Lay the halibut on the tape, or mark the halibut’s length

on the deck and measure that. Do not take a curvilinear length!

- Round to the nearest whole centimeter using the correct rounding rules (e.g. 135.3 cm equals 135 cm; 135.5 cm equals 136 cm).

Record halibut by length/frequency and condition code on the deck sheet and enter this information into the Length and Specimen Form in ATLAS.

Do not record estimated lengths of halibut on the Length and Specimen Form! Record only actual measurements!



Viabilities/injury assessments without a corresponding length cannot be used.

Protocols for Halibut Condition Data (Viability) on Trawlers and Pot Vessels

Halibut mortality data on trawl and pot vessels come from viability data collected by observers. Collect about 10 halibut lengths and viabilities from every sampled haul. When collecting halibut viability data here are some important things to consider:

- Throughout the process of collecting halibut condition data, you must handle halibut carefully to minimize potential injury to the fish.
- Halibut lengths and viability assessments must be from hauls sampled for species composition, including hauls designated for halibut deck sorting.
- Halibut must be *randomly* chosen for viabilities. They can be from either inside or outside your species composition samples. Halibut assessed outside of your samples will be recorded at the haul level.
- Halibut must be examined in hand, and both the eyed and blind sides must be checked while using the dichotomous keys provided. Never guess the condition of the halibut!
- Viabilities must be assessed at the point of discard. When this is not possible, viabilities may be collected at the closest point of discard, however, this is only acceptable when it is determined that nothing beyond your collection point will affect the viability of the halibut.
- Halibut assessed for viabilities must be representative of normal crew handling.

- If you are on a trawl catcher processor and you are unable to collect representative halibut viability data, randomly selected halibut from your species composition samples should be measured and recorded with a viability of “U”.

- If you are on a trawl catcher vessel and everything caught is delivered, halibut from your at-sea samples cannot be assessed since halibut discarded from your sample do not reflect crew handling of halibut and their last point of discard. Randomly selected halibut from your species composition samples should be measured and recorded with a viability of “U”.

- If your vessel is using pelagic trawl gear, record- halibut length data with a viability of unknown. Pelagic trawl gear is most often used by vessels participating in the pollock, atka mackerel, rockfish, and Pacific ocean perch fisheries.

Once you have the halibut in hand you will need to determine if the condition of the halibut is excellent (code E), poor (code P), or dead (code D). For Discard Condition Criteria use the dichotomous keys in “Key to Pacific Halibut Viability for Trawl Vessels” on page A-52 or the dichotomous key in “Key to Pot Condition Codes for Pacific Halibut” on page A-59. If you are not able to assess the halibut or you cannot determine the viability, record the condition as “U” and measure the individual’s length.

You *must* record raw data on your Deck Form to assist yourself and staff if questions arise during your mid-cruise or debriefing interview.

Viabilities on a Catcher Processor Trawler

On a CP, the unit size you choose to collect length and viability data from will depend on the abundance of halibut in the haul. If halibut numbers are high and you anticipate that you’ll get ~ 10 halibut in your species composition, assess those halibut in your samples for viabilities if it is determined that nothing in the factory beyond your sample collection point will affect the viability. If you are assessing viability from within your sample, be sure to assess the halibut immediately as these halibut would normally be discarded right away by factory personnel. If you get more than 10 halibut in your species composition samples, collect length data and assess them all since your samples were randomly chosen for viability data. In a rare instance where you encounter far more than 10 halibut in your species

composition samples, you can further reduce the number of halibut for viabilities by using a random selection method described on page 13-5.

Example: An observer on the factory trawler Aurora Borealis has two locations in the factory where he/she has access to halibut. The first is at the conveyor leaving the live tank, and the second is at the discard area as halibut drop out the discard chute. Between the live tank door and the discard chute are several belts, some with inclines, that halibut have to pass over, falling back and getting squeezed by other fish, until they reach the discard belt some 30 minutes later. A halibut that seems to be in excellent condition when it exited the bin may end up in poor or dead condition by the time it is discarded. To determine how the fishing practices and conditions in the factory have affected halibut viability, the observer must choose the discard belt station for measuring halibut and assessing viability.

Viabilities on Non-Pollock Trawl Catcher Processors or Motherships Conducting Halibut Deck Sorting

Halibut viabilities are collected from deck sorted halibut and also from halibut that enter the factory on non-pollock trawl catcher processors and motherships conducting halibut deck sorting.

- **Deck Sorted Halibut:** Randomly choose halibut for viability assessments using a randomized block design. These halibut are entered at the sample level (sample # 9000).
- **Halibut in the Factory:** Viability data are also collected from halibut that are not deck sorted and enter the factory. Randomly choose halibut for viability assessments at the point of discard. These halibut can be from either inside or outside your species composition samples.

Viabilities on a Catcher Vessel Trawler

On a catcher vessel, take assessments at the point of discard. Catcher vessels may have multiple points of discard to be considered when conducting your viability assessment. Time on deck and handling procedures affect halibut viability. *If you cannot gather representative halibut viabilities at the point of discard, record halibut lengths with a viability of “U.”*

For those instances when you are unable to collect viability data, document the circumstances in your logbook.

Example 1: An observer is on the catcher vessel Pit Bull and the crew normally sorts fish from the trawl alley. As they encounter halibut, they throw them over the side. The observer is only able to collect one species composition sample due to space and time constraints. The observer anticipates he will encounter ~10 halibut in his sample, so the observer decides to use all the halibut in the composition sample for assessments. After collecting his entire sample, he tells the crew they can begin to sort. The observer should assess halibut as they come to them while working up their sample. If the observer were to collect halibut viability data immediately, his assessments would incorrectly document better conditions for the halibut than what normal crew handling would result in. If the time needed to process the sample does not approximately equal the amount of time for the crew to sort, do not use this method.

Example 2: An observer on a catcher vessel collects their species composition sample from a checker bin right after the codend is dumped. After she collects her sample, the crew sorts occasionally from the trawl alley but uses a conveyor belt with an incline to sort fish for the majority of the haul. In this scenario, the observer should collect halibut viabilities outside of their species composition sample at a randomly chosen time. During this randomly chosen time unit, the crew will hand over all the halibut they encounter whether it's from the trawl alley or after the incline belt. The unit of time to get ~10 halibut will be determined by the observer based on the abundance of halibut in the haul.

Viabilities on a Pot Vessel

Halibut for viability assessments on pot vessels must be randomly selected from sampled hauls. Halibut assessed for viability must be collected at the closest point of discard and must reflect how the crew handles the fish.

Random collection of halibut will depend on the abundance encountered in the haul. This can be done by:

- using all the halibut in your samples, or
- selecting non tallied pots or units of time independent of your composition samples.

In your logbook, document all methods you employed for collecting halibut and assessing viabilities. Use your best judgment to determine how much time you can spend collecting halibut for length and viability data. If you are unable to collect about 10 halibut from a sampled haul for viabilities, record in your logbook what factors limited your ability to complete this duty.

Example 1: On a pot catcher vessel, halibut are sorted from the table and discarded right away by throwing them over the rails. Fishing is good so the observer decides to collect her ~ 10 halibut viabilities by randomly choosing non tally pots so that halibut can be obtained and assessed without impacting other sampling duties. The observer determines it will take 4 pots to get ~ 5 halibut so the observer randomly selects 2 units of 4 pots to collect all the halibut. During these randomly chosen pots crew will hand over all halibut encountered in the pots to be assessed for viabilities.

Halibut Injury Assessments on Longliners

In order to assign mortality information to halibut bycatch, the IPHC needs an assessment of injuries to halibut caught as bycatch. These data are analyzed by the IPHC staff and used to estimate future mortality rates. *The halibut you assess for injury must be handled in the same manner as the crew normally handles halibut.*

Protocols for Halibut Condition (Injury) Data on Longline Vessels

Collect halibut and assess their injuries from outside the tally sample period if you are on a *non IFQ vessel*. During the tally period, your full attention will be directed towards making sure everything that comes up on the line is accounted for. Only assess injuries for halibut that you have in hand. Using a random, or systematic random, sampling design, determine the best method to obtain about 10 halibut for injury assessments from every sampled haul. *The data you collect for these individuals are recorded at the haul level.*

To complete halibut injury assessments, measure the halibut, check for injuries using the key found in “Key to Longline Injury Codes for Pacific Halibut” on page A-55, and return the fish to the water.

Use the following rules for assessing halibut injuries on a longliner:

- Injury assessments must come from a randomly chosen unit(s). For longliners not targeting halibut, this will

be during a non tally period and these data must be reported at the haul level.

- Throughout the process of collecting halibut condition data, you must handle halibut carefully to minimize potential injury to the fish.
- Halibut assessed for injury must be “in hand” and measured.
- *You must witness the roller man release halibut chosen for injury assessments.* This will ensure that vessel personnel use the same release methods as they use during normal operations.
- Only assess injuries from halibut that you have in hand. Using the dichotomous key on page A-55, carefully inspect the eyed and blind sides of the halibut to categorize the injury. Never guess the condition of the halibut!
- Ignore any injuries caused by the crew landing the halibut for the injury assessment. This includes gaff wounds caused when bringing the halibut on board for you.
- Document any potential size bias on your Deck Form. This includes halibut selected for injury assessments that drop off, halibut too large to land, sandflea eaten halibut horned off, etc.
- If the vessel uses both a release method that can be duplicated inboard and a method that cannot be duplicated inboard (e.g. hook straightening), length and injury data should still be collected during your randomly selected collection period regardless of the release method used. In these instances document the release methods used by the roller man to collect your assessment fish on a sample by sample basis on the Deck Form. The methods used by each roller man to release halibut when you are not sampling should be documented in your Daily Notes.
- If the vessel is *exclusively* using a release method that cannot be duplicated inboard (e.g. hook straightening) halibut length data should still be collected. List these halibut with injury code “9-unknown”. Document the situation in your Daily Notes and contact your inseason advisor.

Be aware of how halibut are handled when you are not sampling and compare this to when you are sampling.

Document any differences in your logbook. Bring your observation to the attention of the captain and contact NMFS as soon as possible about the problem.

Injury Assessments on IFQ Vessels

In the IFQ fishery, collect about 10 halibut for injury assessments from hauls sampled for species composition.

- *These fish must come from unsorted catch* and be representative of how crew handles the halibut.
- These fish usually will come from outside your tally period and must be randomly collected.
- On some vessels you may be able to collect halibut from inside your composition sample.
- When collecting these data on an IFQ vessel make sure to include retained and non retained halibut.
- Only assess injuries on halibut not retained. List retained halibut lengths with injury code “9 unknown.” *Halibut collected for lengths and not retained by the vessel must be assessed for injury”.*

Example 1: On a catcher processor targeting Pacific cod in the BSAI, the observer determines there are few halibut in the haul. Based on this observation she will need to randomly choose 2 non-tally periods out of 9 available to randomly collect ~ 10 halibut for injury assessments. During these two tally periods, all the halibut are landed under the observer’s watchful eye, measured and assessed for injuries.

Example 2: On a catcher snap gear vessel targeting halibut in the GOA, the observer recognizes the high number of halibut being caught. In order to collect ~10 halibut for lengths and assessments, he randomly chooses a non-tally period out of 3 available. Each non-tally period is comprised of 62 hooks and will take ~ 12.5 minutes to be retrieved. Based on his observations, one non-tally period could yield over twenty halibut so the observer randomly chooses the first half of the non tally period. In total, twelve halibut were collected during the first half of the selected non-tally period. Eight halibut were retained by the vessel therefore measured and recorded with injury code-Unknown. The other four halibut were not retained by the vessel, measured and assessed for injuries.

SALMON DATA COLLECTION

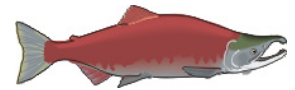

Complete the following salmon tasks in order of priority:

- Collect and report salmon retention data for all AFA pollock CPs, motherships, and plant deliveries of pollock catches. See “Salmon Retention Data in the Pollock Fishery” on page 12-16.
- Identify, count, sex and weigh all the salmon in your species composition samples.
- Collect salmon genetics data on all vessels and deliveries according to fishery area, vessel type protocol, and species. See “Salmon Genetics Sampling” on page 12-13 for this information.
- Catcher Vessel observers complete an offload salmon retention count for all observed GOA pollock deliveries. See “GOA Vessel Observer Offload Salmon Retention Count” on page 5-31.
- Collect sex/lengths and FMA ID scales from salmon according to fishery area and vessel type protocol (See “Salmon Scale Collection Guidelines” on page 12-11).
- Collect tagged salmon data on all vessels and deliveries according to fishery area, vessel type protocol, and species. See “Tagged Salmon” on page 15-2 for tagged salmon protocols.

All raw data must be recorded on your Deck Form.

Salmon in Species Composition Samples

Determine the species of each salmon ID in your at-sea composition samples and record the sexes, numbers, and weights for each species on the Species Composition Form. The six species of salmon ID encountered in the North Pacific are: King (Chinook), Silver (Coho), Steelhead, Sockeye (red), Chum (dog), and Pink (humpy) Salmon.

On AFA pollock CPs and motherships, all salmon from within the observer sample are placed in the salmon storage container after you have collected the required composition data from them. Several vessels will retain salmon for the food bank. The percent retained for each salmon species will be a visual estimation based on your observations and/or guidance from factory personnel.

- On catcher vessels in the directed pollock fishery in the BS and GOA, all salmon in your species composition sample must be placed in the RSW tank to be accounted for at the delivery after you have collected the required composition and biological data from them.
- All GOA trawl catcher vessels must retain salmon to offload.
- On all non-pollock BS vessels and non-trawl GOA vessels, observers collect required composition and biological data and then discard the salmon or return to vessel personnel to dispose of.

Recording Biological Data

Measure and sex all salmon according to the protocols for your vessel/plant type (see “Sex/Length Data for Salmon” on page 12-10). Data records for salmon must be separated by species and sex. You must record raw data on your Deck Form to assist yourself and staff if questions arise during your mid-cruise or debriefing interview.

Salmon Discarded at Sea (Pollock Catchers)

If any salmon are discarded at sea document this in your Daily Notes and Deck Forms and notify NMFS immediately upon delivery or through ATLAS. A Bering Sea pollock vessel observer should track at-sea salmon discards, count and identify them, and provide this information to the plant observer at the delivery. The plant observer will use this information to complete salmon retention data.

At-sea discard of salmon is prohibited in the directed fishery for pollock in the BS and GOA. Observers on catcher vessels directed fishing for pollock in the GOA must include any at-sea salmon discard in their Salmon Retention Data. For more information on collecting and recording data from salmon on a pollock catcher vessel, refer to “GOA Vessel Observer Offload Salmon Retention Count” on page 5-31.

Sex Determination of Salmon

Salmon gonads are far forward in the body and immediately under the backbone. You must cut open salmon to determine sex. Make an incision on the salmon from the pectoral fins and across about mid way up from the belly to see into the top of the peritoneal cavity near the head. The gonads will be two long tubes laying parallel to the backbone. Females, mature and

immature, will have tubes containing granular eggs in sacs that are red, pink, yellow, or orange. Mature males will have smooth textured tubes that are white or cream color. Immature males will have translucent white tubes that appear empty. Data records for salmon must be separated by species and sex.

Sex Determination of Salmon for the Food Bank

Some shoreside processors, floating processors, CPs and motherships retain salmon bycatch for a food donation program. If your vessel delivers to a plant or you are assigned to a processor participating in this program, it is preferred that you sex salmon with a cut from the anus to the isthmus so as not to damage the product.

Sex/Length Data for Salmon

Collect sex/length data from salmon within your species composition sample according to vessel type, fishery, and species. Measure salmon to the fork length using the plastic length strip (see “Measuring Fish” on page 13-6). Record raw salmon sex/length data on your Deck Form and enter it to the Length and Specimen Form. Collect salmon sex/length data according to the following protocols:

- **Bering Sea Pollock Catcher Vessels:** Collect sex and length data from all salmon within your at-sea species composition sample. Sex/length data are recorded at the sample level.
- **GOA Pollock Catcher Vessels:** Collect sex and length data from all salmon within your at-sea and offload salmon retention count. Sex/length data are recorded at the sample level or offload level, depending on where they were found.
- **Plants receiving Bering Sea pollock, AFA CPs, and AFA motherships:** Collect sex/length data only as salmon are removed from the salmon bin. Collect sex and length data from only the Chinook and Chum Salmon selected for genetic sample collection. Collect sex and length data from all other salmon species during your collection of salmon retention data. Sex/lengths for salmon are recorded at the haul level for CPs and motherships. Record sex/lengths at the offload level at plants.
- **GOA pollock deliveries to plants:** Vessel observers will collect salmon sex/length data during the offload salmon retention count and report it at the offload

level. Plant observers do not collect salmon data from GOA pollock deliveries.

- **All vessels not targeting pollock:** Sex and length all salmon within your species composition sample. Sex/length data are recorded at the sample level.

See “Salmon in Species Composition Samples” on page 12-9 for instructions on what to do with salmon in your species composition sample after collecting composition and biological data from them.

SCALE SAMPLE PROTOCOLS

Salmon scales are used to age the salmon, confirm the identity of the species, and in some cases can reveal the area of origin. Salmon scale samples are collected for *two different specimen types*:

1. FMA species identification.
2. Genetics sample collections. See “Salmon Genetics Sampling” on page 12-13.

The physical process of collecting the scales for each of these two types of samples is identical. For each of these uses, collect scales according to the salmon scale collection guidelines.

Salmon Scale Collection Guidelines

Salmon lose scales easily and lost scales are replaced with regenerated scales. Regenerated or lateral line scales are unreadable. To make sure you have usable scale samples, always collect at least 10 scales from the fish and never collect scales from the lateral line.

If the scales are coated with tissue or blood, or the sample is contaminated with other fish scales, it may be useless. Remember, your salmon rubbed against many other fish, even other salmon of different ages and species. To ensure your hard work produces usable data make sure your scale samples are clean.

Salmon scales are collected from "zones" on the fish (see Figure 12-3). Scale zone A is the preferred location followed by zone B and C. The scale zone will be recorded on the envelope and in ATLAS.

1. Wipe the area on the fish where you plan to collect scales. This ensures no other fish scales will be mixed with the individual’s scales. It also removes slime which causes scales to decompose in the scale envelopes.

2. Pluck salmon scales out of the flesh using the forceps or knife. *Minimize mucus on the scales by plucking rather than scraping.* Collect at least 10 scales. For the genetics specimen collection, only 5 scales are needed.
3. If usable scales are limited and the specified number is not possible, divide the available scales between the FMA ID scale specimen and the scale envelope that accompanies the genetic specimen.
4. Each group of scales taken from an individual salmon is placed in a paper envelope to dry. Paper envelopes keep the scales from rotting.
5. Open a salmon scale envelope and wipe the scales inside. Seal the envelope closed.
6. Clean the forceps before collecting scales from another salmon.
7. It is important that you keep the envelopes dry to protect against rot or mildew. Let the envelope dry before storage and do not store your scale samples where they might get wet or moist as this will ruin the specimens.
8. Do not store your FMA ID envelopes with your Genetics envelopes. You Will be required to separate them in debriefing.



Scales are not usable if they are clumped together and dry this way inside the envelope. Pluck scales from the flesh using forceps or a knife. Never scrape scales from the salmon with a knife.

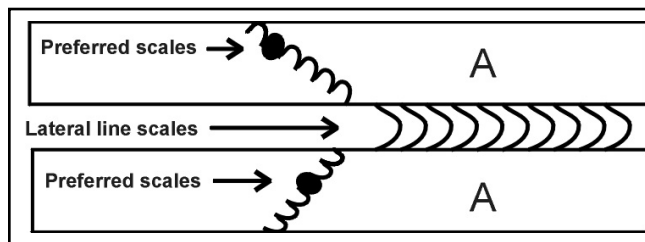

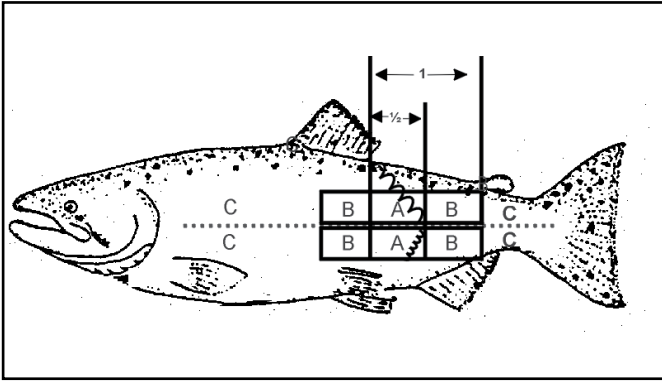

Figure 12-3: Salmon Scale Collection Zones



A sex, length, and weight specimen (code 3) must be recorded for every genetics, FMA ID scale, and salmon snout specimen collected.

Recording Specimen Collection Data on the Deck Form and on the Salmon Envelope

Once you have collected the required number of scales follow these guidelines for salmon data collection and recording your specimen collection raw data on the Deck Form, and on the scale envelope.

1. Weigh the salmon, determine the sex, and measure.
2. Record the salmon's species, length, weight, sex, scale zone information, and adipose fin documentation with a unique specimen number on the Deck Form. Document each zone scales are collected from. Follow the specimen number protocols under "Specimen Number" on page 13-18. Number subsequent specimens (regardless of the species) in consecutive ascending order.

 Scales collected from multiple zones will be recorded in ATLAS as MIXED.

3. Write the species name, specimen number, haul/sample or offload number, scale zone, vessel permit, cruise number, and whether or not the salmon was missing it's adipose fin on the scale envelope. (*Cross out the length, weight, sex, and date fields on Version 1 of the scale envelope*).
4. FMA ID, snouts, and genetics specimens have the same specimen number as the associated sex, length, and weight specimen. All specimen types collected from the same fish must have the same specimen number (see "Salmon Scale Collection Guidelines" on page 12-11).

AM SPECIES Chinook FMA ID SPECIMEN NO. 1
 HAUL/SET 51 DATE _____
 FORK LENGTH _____ (CM) SEX _____
 WT. _____ (KG) MISSING ADIPOSE? Y or N
 CRUISE/ VESSEL CODE 25911 / 7175
 SCALE ZONE A

Figure 12-4: Salmon Scale Envelope Examples for "FMA ID" (Scale Envelope Version 1).

AM SPECIES Chinook Genetics SPECIMEN NO. 1
 HAUL/SET 51 DATE _____
 FORK LENGTH _____ (CM) SEX _____
 WT. _____ (KG) MISSING ADIPOSE? Y or N
 CRUISE/ VESSEL CODE 25911 / 7175
 SCALE ZONE A

Figure 12-5: Salmon Scale Envelope Examples for "Genetics" (Scale Envelope Version 1).

5. If using Scale Envelope Version 1 and the scale came from an offload, cross out the text "Haul/Set" on the envelope and write in the word "Offload" followed by the associated offload number. Label each scale sample specimen envelope with the type of specimen contained in the envelope
 - "FMA ID" for FMA species identification
 - "Genetics" for genetics sample collections
6. The observer that collects the scales will record their initials on the envelope.

| | | | | |
|------------------|---|--------------|----------|-------|
| INITIALS | AM | FMA ID | GENETICS | OTHER |
| SPECIES | King | SPECIMEN NO. | 5 | |
| HAUL/OFFLOAD | 6 | SAMPLE | | |
| MISSING ADIPOSE? | <input checked="" type="radio"/> Y or N | SCALE ZONE | B-C | |
| CRUISE | 12191 | PERMIT | 4184 | |

Figure 12-6: Salmon Scale Envelope Example for "FMA ID" (Scale Envelope Version 2).

| | | | | |
|------------------|---|--------------|----------|-------|
| INITIALS | AM | FMA ID | GENETICS | OTHER |
| SPECIES | King | SPECIMEN NO. | 5 | |
| HAUL/OFFLOAD | 6 | SAMPLE | | |
| MISSING ADIPOSE? | <input checked="" type="radio"/> Y or N | SCALE ZONE | B-C | |
| CRUISE | 12191 | PERMIT | 4184 | |

Figure 12-7: Salmon Scale Envelope Example for "Genetics" (Scale Envelope Version 2).

FMA ID SCALE COLLECTION

The FMA ID salmon scales are used to verify species identifications during your debriefing. Scale collection protocols vary by fishing area, vessel type, and species. Follow the directions below for your FMA ID salmon scale collection.

AFA Pollock CPs and motherships: Collect FMA ID scale specimens from all Chinook Salmon that are randomly selected for genetic specimens. For Chum Salmon, each observer assigned to the vessel must collect FMA ID scale specimens from the first 20 Chum Salmon that are randomly selected for genetic specimens. You must complete the 20 Chum FMA ID scale collection on each AFA Pollock CP and mothership you are assigned to. Collect scale samples from all other salmon species (Coho, Pink, and Sockeye), encountered during the salmon retention count.

Plants and floating processors receiving pollock deliveries: Plant observers collect FMA ID scale

specimens from all Chinook Salmon that are randomly selected for genetic specimens. For Chum Salmon, each observer assigned to the plant or floating processor must collect FMA ID scale specimens from the first 20 Chum Salmon that are randomly selected for genetic specimens. You must complete the 20 Chum FMA ID scale collection at each plant and floating processor you are assigned to. Collect FMA ID scale specimens from all other salmon species (Coho, Pink, and Sockeye), encountered in the offload salmon retention count.

Bering Sea pollock catcher vessels: Collect FMA ID salmon scales from all salmon species within your at-sea species composition sample.

GOA pollock catcher vessels: Collect FMA ID salmon scales systematically from every 20th Chinook and every 20th Chum encountered during your pollock vessel deployment. Maintain the systematic collection for your entire cruise. Collect FMA ID scales from all other salmon species within your at-sea or offload salmon retention count.

BSAI all other vessel types: Collect FMA ID salmon scales from all salmon species within your species composition sample.

GOA all other vessel types: Collect FMA ID salmon scales systematically from every 20th Chinook and 20th Chum encountered during your deployment. Maintain the systematic collection in the GOA regardless of gear type and fishery through your entire cruise. Collect FMA ID scales from all other salmon species within your at-sea or offload salmon retention count.

SALMON GENETICS SAMPLING

Salmon genetics specimens are collected from all pollock CPs and motherships, all GOA fisheries and vessels, and all Bering Sea pollock catcher vessel deliveries. Plant observers do not collect genetic samples from GOA pollock deliveries. Vessel observers are responsible for collecting these data.

Genetic specimens (fin clips plus 5 scales) are collected from both Chinook and Chum Salmon in the pollock fishery. Analysts will examine temporal (early, middle, and late season), geographical, and maturity differences in salmon stock composition.

Genetics finclip sampling gear includes Whatman paper and desiccant packs. The Whatman paper preserves the finclip by drying it out. It is also non reactive to the sample. The desiccant pack absorbs moisture in the plastic bag to keep the samples dry.

Genetics Sampling Bering Sea Pollock: Random Systematic Collection Protocol

Genetic sampling from salmon bycatch in the Bering Sea must follow the random systematic sampling methods described in this manual and meet the following rules:

- Chinook Salmon - The sampling rate is 1 of every 10 Chinook Salmon encountered.
- Chum Salmon - The sampling rate is 1 of every 30 Chum Salmon encountered.
- Genetic samples are not collected from Coho, Pink, and Sockeye Salmon.



If you are overwhelmed with the number of salmon encountered and the associated data collection requirements, document these challenges in your logbook and contact your inseason adviser for further guidance.

Genetics Sampling: GOA Collection Protocol

Genetic sampling from salmon bycatch in the GOA must meet the following rules:

- Chinook and Chum Salmon - A genetics specimen will be collected from *every* Chinook and Chum Salmon encountered in your at-sea species composition sample (all fisheries) and offload salmon retention count (pollock only).
- No genetic samples are collected from Coho, Pink, and Sockeye Salmon.

Bering Sea Salmon Genetics Random Systematic Collection: Getting Started

Randomly select a number from 1-10 for Chinook and from 1 - 30 for Chum at the beginning of your assignment. From this start number, select every 10th Chinook and every 30th Chum encountered for the remainder of your contract.

- The systematic design is “owned” by the lead observer and follows them throughout their deployment to any plant or vessel as lead.

- The second observer coordinates their sampling efforts with the lead to maintain the lead’s systematic design.
- Bering Sea pollock CP and pollock mothership observers: Carry the systematic design haul to haul.
- Plant observers: Carry the systematic design from delivery to delivery.
- Bering Sea pollock catcher vessel observers: Do not collect genetic specimens unless you are assisting the plant observer. Collect these data during their salmon retention count.

Example: At the beginning of your Bering Sea pollock CP cruise you randomly select 3 as your start point for Chinook genetics sample collection. During your first haul you have 14 salmon in your retention data. For haul #1 you collect genetics samples from Chinook 3 and 13 that are removed from the salmon storage container.

- Since you counted 14 Chinook and collected a sample from the 13th fish, your next genetics sample will be collected from the *9th* Chinook encountered.
- Haul #2 has a total of 5 Chinook. The second observer samples the haul and does not collect a genetics sample because it has not been 10 Chinook Salmon since your last collection (during haul #1).
- For haul 3, you begin collecting samples from the *4th* Chinook, because you have had 6 Chinook in the retention data since your last genetics sample.
- Always communicate the next fish to be sampled to your partner observer or the observer assisting you with the collection. *The starting number for each haul’s collection must be noted on the Deck Form.* Be sure to initial the samples that you collected.

Collection Instructions

Follow these guidelines for collecting a salmon genetics sample.

1. Using a knife or scissors, cut a small piece of the pectoral fin. Be sure to include some of the skin between the rays.

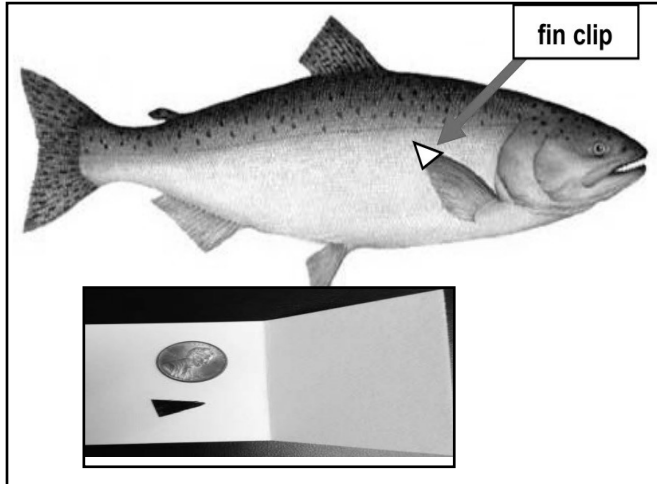

Figure 12-8: Genetics fin clip size and location.

2. Place the fin clip on a piece of Whatman paper, fold over and insert into a scale envelope along with at least 5 scales (preferably from scale zone A) in the same envelope. Use the collection protocol described in “Salmon Scale Collection Guidelines” on page 12-11.
3. If no scales are present, collect only the fin clip for your genetic sample (fin clips without scales are acceptable).
4. If you miss a genetics collection (due to a slight miscount, forgetfulness, etc.), collect a specimen from the next fish, then resume your original systematic sampling interval.
5. If you are unable to collect an accurate length or fin clip from the salmon because it is damaged, use the next fish encountered and then resume your original systematic sampling interval.
6. Record length, weight, sex, and specimen number on the Deck Form. If the fish is missing parts and a whole weight cannot be determined leave the weight field blank. Document the reason in your daily notes and Deck Form.
7. Record the species name, specimen number, haul/offload number and sample number, scale zone, vessel permit, cruise number, and whether or not the salmon was missing the adipose fin on the scale envelope.
8. The observer who collected the genetics specimen must initial the genetic scale envelope. Genetic

samples are recorded as specimen type 4- Fin Clip, with weight entered as specimen type 3-Weight.

9. Number the genetic scale envelopes according to specimen numbering protocols in the “Fish Measurement and Specimen Collection” chapter (see “COMPLETING THE LENGTH AND SPECIMEN FORM” on page 13-16). The genetics specimen number is the same as the sex/length/weight specimen number from the same salmon.
10. Write “genetics” across the top of the envelope, and record data in the Length and Specimen Form in ATLAS. You do not need to seal the envelope
11. Lead and second observers: The lead observer’s cruise number must be recorded on all genetic scale envelopes and data forms
12. All required data must be filled out on the genetics scale envelope.
13. Double-check that the genetics data were recorded on the Deck Form and entered into ATLAS as specimen type 4 “fin clip”.

If You Run Out of Supplies

Genetics must still be collected even if the supplies run out. Make it a priority to resupply when you go in to a location with a field station. Always know what supplies you have on hand to ensure you do not run low on supplies.

1. If you run out of Whatman paper please continue to collect fin clips and store them in regular paper towel in the salmon envelopes.
2. If you run out of envelopes, store the fin clips in labeled whatman paper and transfer them to envelopes when you get more.



Salmon bycatch numbers can be in the hundreds per haul during the summer months. Ensure you have enough Salmon envelopes at the beginning of each trip to accommodate this data requirement

Storage Instructions

Follow these instructions for the proper storage of salmon genetics sample envelopes.

1. After collecting the specimens, allow the envelopes to

fully dry by keeping them in a warm and dry location. There is no need to seal the envelopes, just tuck the flap in,

2. Once the envelopes are dry, place them in a plastic Ziploc bag with the desiccant pack provided. Use a rubber band to keep them bundled by haul and species. Make sure you keep the FMA ID and Genetics envelopes in separate storage bags. They will be going to different end users
3. Keep the dry genetic sample envelopes with the rest of your data and bring them back to your debriefing appointment.



If the storage Ziploc bag with the desiccant pack is full and you cannot fit more genetics envelopes, continue collecting genetic samples and store the envelopes in a regular Ziploc bag.

SALMON RETENTION DATA IN THE POLLOCK FISHERY

Salmon retention data is a full accounting of all salmon caught in a haul or delivery. Along with the normal species composition requirements of trawl vessels, observers in the directed pollock fishery have additional sampling requirements for salmon retention. *Management of the Bering Sea and GOA Chinook Salmon catch limits is dependent on NMFS observer salmon retention data.*

Catcher vessels that are directed fishing for pollock in the Bering Sea are required to deliver all salmon to the plant so that the plant observer may have the opportunity to collect salmon retention and biological data. Catcher vessels that are directed fishing for pollock in the Gulf of Alaska are required to deliver all salmon to the plant so that the vessel observer can monitor the offload and collect salmon retention and biological data. Salmon by catch reporting requirements in the pollock fishery are as follows:

- Observers assigned to Bering Sea pollock CPs or motherships, and plants receiving Bering Sea pollock must report salmon retention data. Plant observers *do not* report salmon retention for GOA pollock deliveries as these data are reported by the vessel observer.
- Plant observers do not record salmon retention data for unobserved GOA pollock deliveries.
- Observers assigned to CVs fishing Bering Sea pollock *do not* complete the Salmon Retention Form.
- Observers assigned to CVs in the directed fishery for pollock in the GOA report salmon retention data.



Salmon are managed by number, not weight. An accurate count of salmon caught is crucial for stock and inseason management!

AFA Pollock Catcher Processors, Motherships, and Plants

One of your highest priorities aboard an AFA pollock CP, mothership, or plant is to collect salmon retention data.

Vessel personnel are responsible for sorting salmon from the catch and placing them in a storage container. All salmon from within the observer sample are placed in this salmon storage container once the observer has collected required composition data from the salmon. At the end of each haul all salmon will be removed from the container for the observer to identify, count and collect biological data. These raw data are recorded on the Deck Form. Refer to “Salmon Retention Recording and Reporting Requirements” on page 12-19 for instructions on recording salmon retention data.

Processors may sort and store salmon from GOA pollock deliveries in the same manner as they sort Bering Sea pollock deliveries, but no retention data from GOA pollock deliveries are reported. Salmon numbers from the GOA pollock fisheries are reported to NMFS in the vessel observer’s offload salmon retention count.

The following points regarding salmon retention must be considered while working aboard an AFA pollock CP or mothership.

1. The vessel is required to sort all salmon. A crew member will be assigned to collect all salmon from each haul.
2. No salmon may pass the observer sample collection point (identified in the sample station inspection diagram).
3. The observer may complete other duties while the crew sorts salmon from the haul and need not be present in the factory for the entire haul.
4. The crew must notify the observer before beginning a count of salmon in the storage container. At the completion of every haul the observer identifies to

species and counts all salmon.

5. Observers must be allowed to collect additional biological data from salmon. See “Salmon Data Collection” on page 12-9.
6. Once the observer has completed counting and sampling of salmon, the crew must remove the salmon from the sampling area in the presence of the observer.
7. The vessel must stop the sorting belt while the observer is collecting salmon retention data and biological data.
8. The observer must complete their salmon retention count and finish collecting biological data before the sorting of the next haul begins.
9. If at any point during the sorting of the haul the salmon become too numerous to be contained in the storage location the vessel must cease all sorting. The observer must be allowed to identify and count all salmon in the bin and to collect biological samples from them prior to the resumption of sorting.
10. The observer must be present at the beginning of each haul to verify that the storage container is empty before sorting starts for the next haul.
11. The observer must be present at the end of each haul to identify and count all the salmon and to collect biological samples.

You must arrange with the crew to be notified that the haul is nearing completion so you can be available to complete the final salmon retention count.

It is useful to note the name of the vessel personnel present for the count and the time of the count on the deck form.

Be sure to let the crew know where to find you. Collecting salmon retention data is your highest data priorities!

Salmon Storage Container

All AFA pollock CP vessels and motherships have an approved storage location for salmon to be saved until the salmon retention count is completed by the observer, usually at the end of each haul.

1. The container must be adjacent to the observer sampling station (as outlined in the sample station diagram).
2. All salmon in the container must remain in view of the observer at the sampling station.
3. The container must be at least 1.5 cubic meters.

Video Requirement

All AFA pollock CPs and motherships are equipped with a factory video monitoring system (also known as electronic monitoring or EM) to track the sorting of salmon.

The observer may be fulfilling other duties and unable to observe the sorting of all salmon, therefore;

1. Video monitoring systems must be used to monitor the salmon storage container and all areas where sorting of salmon might occur.
2. Video monitoring systems consist of cameras, a monitor in the observer sampling station, and digital video recording system.
3. Observers are instructed to notify their inseason advisor if there is a failure of the video system. The observer must document this in the observer logbook Daily Notes section.
4. Observers are instructed to inform the captain if there is a failure of the video system. The observer must document this in the observer logbook Daily Notes section.
5. Video footage must be stored for 120 days.
6. Observers may not view archived video footage without prior authorization from NMFS staff. If the observer suspects a violation by the vessel, they are to notify NMFS staff immediately.

Collection of salmon retention data is a requirement for all CP and mothership hauls or plant deliveries in the directed fishery for Bering Sea pollock and for observed GOA pollock vessel deliveries to processors. If you miss species composition sampling for any reason, you still must collect salmon retention data.

GOA Vessel Observer Offload Salmon Retention Count Guidelines

Salmon retention data from the GOA directed pollock fishery are reported by the vessel observer on the Salmon Retention Form. Please refer to “Salmon Data Collection” on page 12-9 for additional information regarding salmon data collection.

To complete an offload salmon retention count during a GOA pollock delivery:

1. Remove salmon from the sorting belt as you encounter them. You may be the only person on the line and will need to actively sort the salmon from the belt.
2. Record salmon by species and number on the Deck Form.
3. Place the salmon in the designated storage container or area (if the plant has one near your sample area). Some plants in Kodiak will have you place the salmon back on the belt once you have collected your retention and biological data and plant personnel will sort them later.
4. If salmon are discarded at sea be sure to include these in your salmon retention data.
5. Take care not to double count salmon from your at-sea samples during your offload salmon retention count. Those salmon encountered at sea will already be cut for sex determination (when found during the offload). Document and contact the Observer Program immediately if you have sampled a salmon at sea, placed it in the RSW tank, and do not encounter it during your offload salmon retention count.
6. After-scale salmon must be included in your salmon retention data *only* if you can verify those salmon came from your offload. If you are not able to verify this, do not include these after-scale in your salmon retention data. See “GOA Plant After-Scale Salmon” on page 5-32 for after-scale verification guidelines.
7. Do not make changes to your salmon numbers based on the salmon numbers recorded on the fish ticket.
8. Report the salmon data in the Salmon Retention Form in ATLAS.
9. Genetic samples will be collected during the offload. Work efficiently during the plant’s regular breaks so that you are not overwhelmed with salmon. Do

not collect genetic samples while fish are running on the belts. During this time you must be actively monitoring and sorting salmon from the fish running on the belt.



It is unacceptable to miss any portion of an offload. If any of your offload is missed, document the circumstances and contact NMFS immediately.

10. The plant observer at an AFA processor (plants receiving Bering Sea pollock) may assist vessel observers in monitoring GOA deliveries.

In addition to the vessel observer monitoring the offload for salmon bycatch you will collect genetic specimens and FMA ID scales from salmon bycatch. See page 12-11 for a description of FMA ID scale collections and page 12-13 for a description of salmon genetics collection.

Observer actions resulting in the offload not being 100% monitored will affect the reliability of the salmon retention and genetics data and may reflect poorly on the observer’s work performance evaluation.

Offload Salmon Retention Count Deck Form

Record offload data on the Deck Form using the guidelines below. Remember that all raw data must be retained. Refer to the example on page 5-61 as a template for organizing your data on the Deck Form.

- Complete the header information on the Deck Form with the date, cruise, permit and offload number. Include page numbers.
- Number your offloads consecutively starting with your first offload on the vessel.
- Show the totals of all five salmon species found during the offload as well as any discarded at sea. If the species is not present record it with a zero for the number present. For example, if no Pink Salmon are found in the offload record “pink-0” on the Deck Form and in the Salmon Retention data. At sea discards included in the offload should be clearly noted on the Deck Form.
- If no salmon are found during your offload salmon retention count complete a Deck Form as noted above and write “No Salmon in Offload” on the form, (see page 5-62 for an example).
- Record the approximate start time and end time of the offload.

- Note on the Deck Form the number and possible species if any salmon may have been missed during the offload. Some plants have hard to access areas. Please note if this affected your ability to sort salmon from the offload.
- Include after-scale salmon on the offload Deck Form. Make sure they are clearly noted as after-scale salmon.
- Note if there was any assistance from another observer.
- Note if you missed any part of the offload and document why you may have missed a portion of the offload.
- Only salmon specimens found during the offload should be listed on the offload Deck Form. This includes any after-scale salmon.
- If, during an offload retention count, you encounter a salmon that you had in an at-sea sample, include it in the retention count. You should have already collected appropriate data from the salmon (e.g. sex/length, FMA ID, genetics) and these data should only be reported once.

Do not use the salmon numbers listed on the fish ticket.

Record the salmon retention information in ATLAS on the Salmon Retention Form. You must have a single line of entry for each salmon species in ATLAS (see “Salmon Retention Data in the Pollock Fishery” on page 12-16). Document any significant or unusual events on the Deck Form and elaborate in your daily notes.



Salmon are managed by number, not weight. An accurate count of salmon caught is crucial for inseason and stock management!

SALMON RETENTION RECORDING AND REPORTING REQUIREMENTS

Vessels that are directed fishing for pollock in the Bering Sea and GOA are required to save all salmon on a haul by haul or delivery basis until these salmon may be counted by a NMFS-certified observer for salmon retention reporting and the observer has the opportunity to collect biological data. Bering Sea salmon retention data must be reported daily via ATLAS. Gulf of Alaska salmon retention data must be reported upon completion of the delivery. Retention reporting requirements are as follow:

- **Bering Sea Catcher Processor Trawlers, Motherships, and Processing Plants:** Collect salmon retention data and submit these data via ATLAS for their vessel or for Bering Sea pollock deliveries to their plant (see “Salmon Data Form” on page 18-18). For instructions on completing this form see “Salmon Retention Form Instructions” shown below.
- **Gulf of Alaska Pollock:** Catcher vessel observers must enter retention data for all deliveries to shoreside or floating processors. Retention data is not reported for deliveries to tender vessels.
- Enter salmon retention data from all Bering Sea CP and mothership pollock hauls, Bering Sea pollock deliveries and GOA pollock deliveries even when there were no salmon found!

All raw data must be documented on your Deck Form. See page 5-49 for an example of the expected level of documentation.

Bering Sea Catcher Vessels

Catcher vessel observers must give the plant observer the numbers by species of any salmon discarded at sea. The plant observer accounts for all salmon from the vessel on the Salmon Retention Form so it is essential that you give this information to them. Notify NMFS of any salmon discards and document the discard in your Daily Notes, including any discards of large amounts of unsorted catch as this may have contained salmon.

Salmon Retention Form Instructions

Some of the fields in the ATLAS Salmon Data section will be automatically filled in by the computer. You will need to enter the following data:

- **Offload/Haul Number:** Enter the offload or haul number from the Offload or Vessel Haul Form.
- **Temperature Scale:** In the “Scale” field, enter the Surface temperature and/or Fishing temperature at the time of retrieval (if available). The codes are:
 - F – Fahrenheit
 - C – Centigrade
 - N – No data available
- **Salmon Numbers:** The total numbers are the total of species counted and identified from the approved salmon storage containers (BSAI) or found during your

PROHIBITED SPECIES SAMPLING: SALMON RETENTION RECORDING AND REPORTING REQUIREMENTS

offload salmon retention count (GOA). Remember to include damaged salmon in your count. Salmon that have been identified as fish waste (e.g. those that were previously processed) should not be included in the salmon retention count. See "Decomposed Fish, Fish Waste, Damaged Fish, and Miscellaneous Items" on page 5-25 for more information. For BSAI pollock, crew members will be present to assist you with counting and verifying the identification of each salmon. **Do not estimate which unidentified salmon would have been Chinook, Chum, Pink, Sockeye, or Coho based on your sample data.**

Any salmon that you cannot identify must be saved as a specimen and turned into the NMFS field office for identification.

List the salmon to species on your Deck Form and enter the data into ATLAS.

Enter "0" for each species that was not encountered during the haul or delivery. Enter the number of salmon by species:

- Chinook
- Chum
- Coho
- Sockeye
- Pink
- Unidentified - Use for all salmon you do not personally identify

• **Salmon Census Source:** *This field is completed by Plant observers and GOA pollock vessel observers only.* Enter one of the following codes below in response to the question "From where did the majority of salmon in the Salmon Numbers field above come from?" For these codes, "observed fish" refers to any salmon either directly sorted by an observer or under the direction of an observer. ***Leave this field blank when no salmon are found during an offload.***

Code 6 = Observed Only- The salmon census derived from fish either directly sorted by the observer or sorted under the direction of the observer. Code 6 cannot be used if there are after-scale salmon or unidentified salmon discarded at sea.

Code 5 = Mixed Observed- The salmon census derived from both observed and unobserved fish, but primarily (>50%) observed.

Code 4 = Mixed Industry- The salmon census derived from both observed and unobserved fish, but primarily (>50%) unobserved.

Code 3 = Industry Only- The salmon census mostly derived from industry staff at times and from places unknown to the observer.

If you use code 5, 4, or 3, document the reasons some salmon were not observed!

Fish returned to the observer as after-scale, either during an offload or after the offload is complete, are considered unobserved fish. An offload with one or more after-scale salmon require a code of 5, 4 or 3. See "GOA Pollock Offload Monitoring: Verifying After-Scale Salmon" on page 5-32 for a definition of after- scale.

Bering Sea salmon discarded at sea without in-hand identification by the vessel observer should be reported to the plant observer (to add to the salmon retention information). Use code 5, 4, or 3 according to the most suitable of the definitions above.

Example (Bering Sea pollock CV delivery): While the vessel and plant observer monitored the offload the plant personnel sorted out a combined total of 6 salmon and placed them in the salmon bin. During the offload a salmon passed unsorted into the factory and was brought to the observer by plant personnel as after- scale and placed in the salmon bin. After the offload, an additional salmon was brought to the plant observer's attention as another "after-scale" fish, bringing the total number of salmon from the offload to 8. The percent of observed salmon is $(6/8) \times 100 = 75\%$. The Salmon Census Source is Code 5- (Mixed Observed) because >50% of salmon were observed fish.



CP and mothership observers DO NOT enter a salmon source code. CP and mothership observers leave this field blank when entering data into ATLAS.

PROHIBITED SPECIES SAMPLING: SALMON RETENTION RECORDING AND REPORTING REQUIREMENTS

DECK FORM

| | | | | | |
|----------|--------|--------|----------|-------------|--|
| Date | Cruise | Permit | Haul No. | Offload No. | Page <u>1</u> of _____ for Vessel/Plant |
| 07/13/23 | 20670 | 2345 | 165 | | Page <u>1</u> of <u>2</u> for Haul/Offload |

| | | | | |
|---------------------------------|---|----------------------------|--|---|
| Sample #: <u>1</u> | Sub-Sample #: | Sample Size: <u>350.85</u> | <small>Kgs Segments pots</small> | # of Sampled Hooks: |
| Presorted <input type="radio"/> | Combined <input checked="" type="radio"/> | | | No Fish in Sample <input type="radio"/> |

| Species | Sex | # | Weight | % ret. | Length, viability, injury, specimen, taly data, measurements, bird observations, sample design, notes: |
|----------------------|-------------------------------------|------------|---------------|-------------------------------------|--|
| ----- KEYPUNCH ----- | <input checked="" type="checkbox"/> | <u>322</u> | <u>350.85</u> | <input checked="" type="checkbox"/> | <u>Pollock S/L</u> |
| Pollock | | <u>35</u> | <u>43.80</u> | <u>100</u> | <u>M</u> |
| Pollock | | <u>18</u> | <u>21.80</u> | <u>100</u> | <u>F</u> |
| Pollock | | <u>30</u> | <u>40.20</u> | <u>100</u> | <u>44-1</u> |
| Pollock | | <u>25</u> | <u>31.60</u> | <u>100</u> | <u>(47)-L</u> |
| P. Cod | | <u>2</u> | <u>19.80</u> | <u>100</u> | <u>48-L</u> |
| Flathead Sole | | <u>21</u> | <u>5.20</u> | <u>100</u> | <u>49-L</u> |
| Rex Sole | | <u>3</u> | <u>2.10</u> | <u>100</u> | <u>51-L</u> |
| N. Rock Sole | | <u>3</u> | <u>2.20</u> | <u>100</u> | <u>52-L</u> |
| | | | | | <u>(53)-□</u> |
| | | | | | <u>(53)-1</u> |
| | | | | | <u>55-L</u> |
| | | | | | <u>(59)-1</u> |
| | | | | | <u>63-1</u> |
| | | | | | <u>64-1</u> |

| | |
|-------------------------|---|
| <u>Pollock Otoliths</u> | sp#1- M/53/1.60-393070 #2- M/47/95-393073 #3- F/60/190-393078 (Pre-spawn) #4- M/59/1.75-393071 #5- F/53/1.30-393077 (Pre-spawn) #6- F/54/1.55-393072 (Pre-spawn) #7- M/52/1.25-393080 #8- M/52/1.30-393076 |
|-------------------------|---|

| | | | | |
|--|--|--|--|--|
| Gulf of Alaska catcher vessel example | | | | |
|--|--|--|--|--|

| | | | | |
|---------------------------------|--------------------------------|--------------|--|---|
| Sample #: <u>2</u> | Sub-Sample #: | Sample Size: | <small>Kgs Segments pots</small> | # of Sampled Hooks: |
| Presorted <input type="radio"/> | Combined <input type="radio"/> | | | No Fish in Sample <input type="radio"/> |

| Species | Sex | # | Weight | % ret. | Length, viability, injury, specimen, taly data, measurements, bird observations, sample design, notes: |
|----------------------|-------------------------------------|-----------|--------------|-------------------------------------|---|
| ----- KEYPUNCH ----- | <input checked="" type="checkbox"/> | | | <input checked="" type="checkbox"/> | <u>*found 3 Flathead on deck next to where s1+s2 were stored. Not sure which sample they belong to so I combined them</u> |
| Pollock | | <u>36</u> | <u>43.60</u> | <u>100</u> | <u>P. Cod S/L</u> |
| Pollock | | <u>37</u> | <u>44.20</u> | <u>100</u> | <u>M</u> |
| Pollock | | <u>30</u> | <u>35.60</u> | <u>100</u> | <u>F</u> |
| Pollock | | <u>30</u> | <u>37.40</u> | <u>100</u> | <u>(77)-1</u> |
| P. Cod | | <u>1</u> | <u>7.80</u> | <u>100</u> | <u>(89)-1</u> |
| Poacher U. | | <u>1</u> | <u>.05</u> | <u>100</u> | <u>(96)-1</u> |
| Flathead Sole | | <u>24</u> | <u>5.30</u> | <u>100</u> | |
| Rex Sole | | <u>2</u> | <u>1.15</u> | <u>100</u> | <u>Bairdi S/L</u> |
| Arrowtooth | | <u>11</u> | <u>3.75</u> | <u>100</u> | <u>M</u> |
| AK. Skate | | <u>1</u> | <u>1.80</u> | <u>100</u> | <u>F</u> |
| Bairdi | <u>M</u> | <u>6</u> | <u>2.20</u> | <u>100</u> | <u>103-L</u> |
| Bairdi | <u>F</u> | <u>6</u> | <u>1.30</u> | <u>100</u> | <u>93-L no eggs</u> |
| | | | | | <u>108-1</u> |
| | | | | | <u>93-1 eggs</u> |
| | | | | | <u>123-L</u> |
| | | | | | <u>103-1 no eggs</u> |
| | | | | | <u>108-L eggs</u> |

| | |
|------------------------|----------------------------------|
| <u>P. Cod Otoliths</u> | sp#9-F/89/9.40/393074 (spawning) |
|------------------------|----------------------------------|

Tanner and king crab species are measured in increments of millimeters. All crab measurements must end in "3" or "8". Check for the presence of eggs in all females.

Figure 12-9: Example of Expected Documentation for Prohibited Crab Species Biological Data Collections

PROHIBITED SPECIES SAMPLING: SALMON RETENTION RECORDING AND REPORTING REQUIREMENTS

DECK FORM

| | | | | | |
|----------|--------|--------|----------|-------------|--|
| Date | Cruise | Permit | Haul No. | Offload No. | Page <u>2</u> of _____ for Vessel/Plant |
| 07/13/23 | 20670 | 2345 | 165 | | Page <u>2</u> of <u>2</u> for Haul/Offload |

| | | | | |
|---------------------------------|--------------------------------|----------------------------|--|---|
| Sample #: <u>3</u> | Sub-Sample #: | Sample Size: <u>135.60</u> | <small>Kgs Segments pots</small> | # of Sampled Hooks: |
| Presorted <input type="radio"/> | Combined <input type="radio"/> | | | No Fish in Sample <input type="radio"/> |

| Species | Sex | # | Weight | % ret. | |
|----------------------|-------------------------------------|-----|--------|-------------------------------------|---|
| ----- KEYPUNCH ----- | <input checked="" type="checkbox"/> | | | <input checked="" type="checkbox"/> | Length, viability, injury, specimen, tally data, measurements, bird observations, sample design, notes: |
| Pollock | | 119 | 135.60 | | <p><u>Chinook Genetics</u> sp# 10- F/69/4.1/Adipose present/ Zone A sp# 11- F/52/2.3/Adipose present/ Zone A</p> <div style="border: 1px solid black; padding: 5px; margin: 10px 0;"> Genetics were collected at sea from the two Chinook found in the species composition sample. The specimen data were entered at the sample level. Both Chinook were placed in the RSW tanks to be included in the offload Salmon Retention Count. </div> <p><u>Bairdi S/L</u> M F 88-1 73-1 eggs</p> |
| Pollock | | 30 | 36.60 | 100 | |
| Pollock | | 20 | 23.80 | 100 | |
| Pollock | | 30 | 35.80 | 100 | |
| Pollock | | 21 | 24.80 | 100 | |
| Flathead Sole | | 7 | 3.00 | 100 | |
| N. Rock Sole | | 2 | .75 | 100 | |
| Arrowtooth | | 4 | 1.05 | 100 | |
| Chinook | F | 2 | 6.40 | 100 | |
| Halibut | | 1 | 3.00 | 100 | |
| Bairdi | M | 1 | .25 | 100 | |
| Bairdi | F | 1 | .15 | 100 | |

| | | | | |
|---------------------------------|--------------------------------|--------------|--|---|
| Sample #: | Sub-Sample #: | Sample Size: | <small>Kgs Segments pots</small> | # of Sampled Hooks: |
| Presorted <input type="radio"/> | Combined <input type="radio"/> | | | No Fish in Sample <input type="radio"/> |

| Species | Sex | # | Weight | % ret. | |
|----------------------|-------------------------------------|---|--------|-------------------------------------|--|
| ----- KEYPUNCH ----- | <input checked="" type="checkbox"/> | | | <input checked="" type="checkbox"/> | Length, viability, injury, specimen, tally data, measurements, bird observations, sample design, notes: |
| | | | | | <p>* FMA ID - take Chinook 4 take Chum 3</p> <div style="border: 1px solid black; padding: 5px; margin: 10px 0;"> In the GOA catcher vessel observers collect genetic specimens from <i>all</i> King and Chum Salmon encountered in their at-sea species composition samples. These data are recorded at the sample level. </div> |
| | | | | | |
| | | | | | |
| | | | | | |
| | | | | | |
| | | | | | |
| | | | | | |
| | | | | | |
| | | | | | |
| | | | | | |
| | | | | | |
| | | | | | |

Figure 12-10: Example of Expected Documentation for Salmon Biological data in the GOA

DECK FORM

| | | | | | |
|----------|--------|--------|----------|-------------|--|
| Date | Cruise | Permit | Haul No. | Offload No. | Page <u>3</u> of _____ for Vessel/Plant |
| 07/15/23 | 20670 | 2345 | | 1 | Page <u>1</u> of <u>1</u> for Haul/Offload |

| | | | | | |
|---------------------------------|--------------------------------|--------------|-------------------------|------------------------|---|
| Sample #: | Sub-Sample #: | Sample Size: | Kgs Segments pots | # of Sampled Hooks: | No Fish in Sample <input type="radio"/> |
| Presorted <input type="radio"/> | Combined <input type="radio"/> | | | | |

| Species | Sex | # | Weight | % ret. | |
|--|-----|---|--------|--------|--|
| ----- KEYPUNCH ----- | X | | | X | Length, viability, injury, specimen, tally data, measurements, bird observations, sample design, notes: <div style="border: 1px solid black; padding: 5px;"> <h4 style="text-align: center;">Salmon Retention Count Count</h4> <p>(includes 2 chinook from @sea samples H165, sample 3)</p> <p>Chinook - <input checked="" type="checkbox"/> 4 (8)</p> <p>Chum - L (2)</p> <p>Coho - 1 (1)</p> <p>Sockeye - 0</p> <p>Pink - 0</p> <p>* FMA ID - Take Chinook - 2 Take Chum - 3</p> </div> |
| <u>Chinook Genetics:</u> | | | | | |
| sp#12 - M/56/3.00/Adipose present/Zone A | | | | | |
| sp#13 - M/42/2.80/Adipose present/Zone A | | | | | |
| FMA ID Fish - Zone A | | | | | |
| sp#14 - M/63/3.20/Adipose present/Zone C | | | | | |
| sp#15 - F/60/3.00/Adipose present/Zone A | | | | | |
| sp#16 - F/51/2.60/Adipose present/Zone A | | | | | |
| sp#17 - M/58/3.80/Adipose present/Zone B | | | | | |
| <u>Chum Genetics</u> | | | | | |
| sp#18 - M/61/3.90/Adipose Present/Zone A | | | | | |
| sp#19 - M/58/3.80/Adipose Present/Zone C | | | | | |

| | | | | | |
|---------------------------------|--------------------------------|--------------|-------------------------|------------------------|---|
| Sample #: | Sub-Sample #: | Sample Size: | Kgs Segments pots | # of Sampled Hooks: | No Fish in Sample <input type="radio"/> |
| Presorted <input type="radio"/> | Combined <input type="radio"/> | | | | |

| Species | Sex | # | Weight | % ret. | |
|--|-----|---|--------|--------|--|
| ----- KEYPUNCH ----- | X | | | X | Length, viability, injury, specimen, tally data, measurements, bird observations, sample design, notes: <div style="border: 1px solid black; padding: 5px;"> <p>Genetic specimens are collected from all Chinook and Chum Salmon during the offload, these data are recorded at the offload level.</p> <p>FMD ID for next haul/offload: - Last Chinook - 4 (next 16) - Last Chum: 2 (next 1)</p> </div> |
| <u>Coho FMA ID</u> | | | | | |
| sp#20 - M/55/3.60/Adipose Present/Zone B | | | | | |
| | | | | | |
| | | | | | |
| | | | | | |
| | | | | | |
| | | | | | |
| | | | | | |
| | | | | | |

National Marine Fisheries Service/Fisheries Monitoring and Analysis Division Ver. 2010

Figure 12-11: Example of Expected Documentation for Salmon Retention Count and Salmon Biological Data Collection at the Offload level in the GOA

PROHIBITED SPECIES SAMPLING: SALMON RETENTION RECORDING AND REPORTING REQUIREMENTS

DECK FORM

| | | | | | |
|----------|--------|--------|----------|-------------|--|
| Date | Cruise | Permit | Haul No. | Offload No. | Page <u>22</u> of _____ for Vessel/Plant |
| 10/17/23 | 22834 | 5678 | 35 | | Page <u>1</u> of <u>2</u> for Haul/Offload |

| | | | | |
|---------------------------------|--------------------------------|----------------------------|--|---|
| Sample #: <u>1</u> | Sub-Sample #: | Sample Size: <u>115.00</u> | <small>Kgs Segments pots</small> | # of Sampled Hooks: |
| Presorted <input type="radio"/> | Combined <input type="radio"/> | | | No Fish in Sample <input type="radio"/> |

| Species | Sex | # | Weight | % ret. | Length, viability, injury, specimen, tally data, measurements, bird observations, sample design, notes: |
|----------------------|-------------------------------------|-----------|---------------|-------------------------------------|---|
| ----- KEYPUNCH ----- | <input checked="" type="checkbox"/> | <u>89</u> | <u>115.00</u> | <input checked="" type="checkbox"/> | |
| Pollock | | <u>29</u> | <u>31.80</u> | <u>100</u> | |
| Pollock | | <u>26</u> | <u>33.60</u> | <u>100</u> | |
| Pollock | | <u>30</u> | <u>34.40</u> | <u>100</u> | |
| P. Cod | | <u>1</u> | <u>4.20</u> | <u>100</u> | |
| Chum | <u>F</u> | <u>2</u> | <u>8.30</u> | <u>100</u> | |
| Chum | <u>M</u> | <u>1</u> | <u>2.70</u> | <u>100</u> | |
| | | | | | |

| | | | | |
|---------------------------------|--------------------------------|----------------------------|--|---|
| Sample #: <u>2</u> | Sub-Sample #: | Sample Size: <u>113.10</u> | <small>Kgs Segments pots</small> | # of Sampled Hooks: |
| Presorted <input type="radio"/> | Combined <input type="radio"/> | | | No Fish in Sample <input type="radio"/> |

| Species | Sex | # | Weight | % ret. | Length, viability, injury, specimen, tally data, measurements, bird observations, sample design, notes: |
|----------------------|-------------------------------------|-----------|---------------|-------------------------------------|---|
| ----- KEYPUNCH ----- | <input checked="" type="checkbox"/> | <u>85</u> | <u>113.10</u> | <input checked="" type="checkbox"/> | |
| Pollock | | <u>36</u> | <u>43.20</u> | <u>100</u> | |
| Pollock | | <u>25</u> | <u>32.40</u> | <u>100</u> | |
| Pollock | | <u>16</u> | <u>17.60</u> | <u>100</u> | |
| Jelly fish | | <u>3</u> | <u>3.90</u> | <u>100</u> | |
| Chum | <u>F</u> | <u>3</u> | <u>9.60</u> | <u>100</u> | |
| Chum | <u>M</u> | <u>2</u> | <u>6.40</u> | <u>100</u> | |
| | | | | | |

Tally K/P

Ver. 2016

Figure 12-12: Example of Expected Documentation for Salmon Biological Data Collection In the Bering Sea

DECK FORM

| | | | | | |
|---------|--------|--------|----------|-------------|---|
| Date | Cruise | Permit | Haul No. | Offload No. | Page <u>2</u> of _____ for Vessel/Plant |
| 4/06/23 | 28500 | 6636 | 102 | | Page <u>1</u> of _____ for Haul/Offload |

| | | | | |
|---------------------------------|--------------------------------|-----------------------|-------------------|---|
| Sample #: <u>1</u> | Sub-Sample #: | Sample Size: <u>2</u> | Kgs Segments pots | # of Sampled Hooks: |
| Presorted <input type="radio"/> | Combined <input type="radio"/> | | | No Fish in Sample <input type="radio"/> |

| Species | Sex | # | Weight | % ret. | Length, viability, injury, specimen, tally data, measurements, bird observations, sample design, notes: | | | | | | | | | | | | | | | | | | |
|----------------------|-------------------------------------|------------|---------------|-------------------------------------|--|-------|-------|-------|-------|------|-------|-------|-------|-------|----|--|--|--|--|--|----|--|--|
| ----- KEYPUNCH ----- | <input checked="" type="checkbox"/> | <u>295</u> | <u>101.85</u> | <input checked="" type="checkbox"/> | <p>18seg x 1/3 = 6seg : 3 samples = 2seg/unit 18seg ÷ 2seg/unit = 9units RN=1 S/L RN=1</p> <table border="1" style="font-size: small; margin: 5px;"> <tr> <td>1-2</td><td>3-4</td><td>5-6</td><td>7-8</td><td>9-10</td><td>11-12</td><td>13-14</td><td>15-16</td><td>17-18</td> </tr> <tr> <td>51</td><td></td><td></td><td></td><td></td><td></td><td>53</td><td></td><td></td> </tr> </table> <p>Halibut Injury - Seg 4 PCod - (163) D/O L=3 Pollock - (34) D/O L=2 Bathyrja - 2222211 (23)</p> <div style="border: 1px solid black; padding: 5px; width: fit-content;"> <p>Do not report estimated lengths as biological data! On longliners, estimated lengths for halibut inside your sample are used <i>only</i> to determine a weight for those halibut seen during the tally period.</p> </div> <p style="text-align: right;">Tally K/P: <u>295</u></p> | 1-2 | 3-4 | 5-6 | 7-8 | 9-10 | 11-12 | 13-14 | 15-16 | 17-18 | 51 | | | | | | 53 | | |
| 1-2 | 3-4 | 5-6 | 7-8 | 9-10 | | 11-12 | 13-14 | 15-16 | 17-18 | | | | | | | | | | | | | | |
| 51 | | | | | | | 53 | | | | | | | | | | | | | | | | |
| P. Cod | | <u>163</u> | <u>0</u> | <u>94</u> | | | | | | | | | | | | | | | | | | | |
| Pollock | | <u>5</u> | <u>8.00</u> | <u>92</u> | | | | | | | | | | | | | | | | | | | |
| Pollock | | <u>29</u> | <u>0</u> | <u>92</u> | | | | | | | | | | | | | | | | | | | |
| A.K. Skate | | <u>3</u> | <u>22.40</u> | <u>0</u> | | | | | | | | | | | | | | | | | | | |
| Aleutian Skate | | <u>2</u> | <u>10.75</u> | <u>0</u> | | | | | | | | | | | | | | | | | | | |
| Bathyrja | | <u>18</u> | <u>0</u> | <u>0</u> | | | | | | | | | | | | | | | | | | | |
| Arrowtooth | | <u>4</u> | <u>3.21</u> | <u>0</u> | | | | | | | | | | | | | | | | | | | |
| Kamchatka | | <u>1</u> | <u>.86</u> | <u>0</u> | | | | | | | | | | | | | | | | | | | |
| Kam / Arrow | | <u>14</u> | <u>0</u> | <u>0</u> | | | | | | | | | | | | | | | | | | | |
| Flathead Sole | | <u>5</u> | <u>3.15</u> | <u>0</u> | | | | | | | | | | | | | | | | | | | |
| Flathead Sole | | <u>12</u> | <u>0</u> | <u>0</u> | | | | | | | | | | | | | | | | | | | |
| Northern R.S. | | <u>5</u> | <u>3.70</u> | <u>0</u> | Sculpin - <input checked="" type="checkbox"/> L (8) | | | | | | | | | | | | | | | | | | |

| | | | | |
|---------------------------------|--------------------------------|--------------|-------------------|---|
| Sample #: | Sub-Sample #: | Sample Size: | Kgs Segments pots | # of Sampled Hooks: |
| Presorted <input type="radio"/> | Combined <input type="radio"/> | | | No Fish in Sample <input type="radio"/> |

| Species | Sex | # | Weight | % ret. | Length, viability, injury, specimen, tally data, measurements, bird observations, sample design, notes: |
|----------------------|-------------------------------------|-----------|--------------|-------------------------------------|---|
| ----- KEYPUNCH ----- | <input checked="" type="checkbox"/> | | | <input checked="" type="checkbox"/> | <p><u>Halibut</u></p> <div style="border: 1px solid black; padding: 5px; width: fit-content;"> <p>50 - L - 3 60 - L - 1 70 - 80 - <input checked="" type="checkbox"/> - 5 90 -</p> <p>(9) @ 37.08</p> </div> <p><u>Arrowtooth oto's</u> sp#1 - M/46/1.3 #521635</p> <p><u>Halibut Injuries</u> (Haul level) 51 - minor 63 - moderate 82 - minor 49 - minor 63 - severe 76 - moderate 71 - minor</p> <p style="text-align: right;">Tally K/P: <u>295</u></p> |
| Rock Sole U. | | <u>12</u> | <u>0</u> | <u>0</u> | |
| Sea Whip | | <u>1</u> | <u>.02</u> | <u>0</u> | |
| Sea Whip | | <u>1</u> | <u>.15</u> | <u>0</u> | |
| Sea Whip | | <u>1</u> | <u>0</u> | <u>0</u> | |
| Great Sculpin | | <u>5</u> | <u>10.73</u> | <u>0</u> | |
| Sculpin U. | | <u>3</u> | <u>0</u> | <u>0</u> | |
| Yellow I. L. | | <u>2</u> | <u>1.80</u> | <u>0</u> | |
| Halibut | | <u>9</u> | <u>37.08</u> | <u>0</u> | |
| | | | | | |

On non IFQ longliners, halibut biological data is collected from **outside** the tally samples. Report these data at the **haul level**.

Figure 12-13: Example of Expected Documentation for Biological Data Collected for Halibut on a Longliner

This page intentionally left blank.

FISH MEASUREMENT AND SPECIMEN COLLECTION

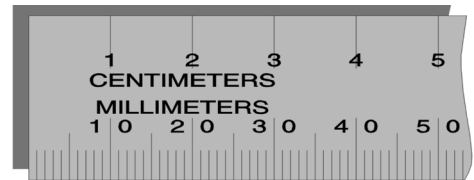

Table of Contents

| | |
|---|-------|
| Priorities | 13-1 |
| Introduction | 13-1 |
| Uses of Biological Data | 13-2 |
| Collecting Fish for Sex/Length and Specimen Data | 13-2 |
| Selection of Species for Specimen Samples | 13-3 |
| Collecting Sex/Lengths and Specimen Data from a Haul | 13-4 |
| Avoiding Size Bias/ Hand Selection | 13-4 |
| Measuring Fish | 13-6 |
| Otolith Specimen Collection | 13-8 |
| Tracking Your Otolith Collection | 13-9 |
| Selecting Fish for Otolith Specimens | 13-9 |
| How to Collect Otoliths | 13-9 |
| Broken Otoliths | 13-11 |
| If You Run Out of Otolith Vials | 13-11 |
| Sex Determination of Fish | 13-11 |
| Regulatory Support for Cutting Fish to Obtain Sex Data | 13-11 |
| Alternatives to Cutting Fish to Determine Sex | 13-12 |
| Sex Determination of Sharks | 13-12 |
| Other Length and/or Specimen Collections | 13-12 |
| Pacific Cod and Pollock Maturity Scan Data | 13-12 |
| GOA Skate Age and Maturity Collection | 13-13 |
| Sturgeon | 13-15 |
| Salmon Genetics | 13-15 |
| Shark Sex Length Data | 13-15 |
| Research Projects | 13-16 |
| Completing the Length and Specimen Form | 13-16 |
| Sample Design | 13-16 |
| Viability and Injury | 13-17 |
| Specimen Number | 13-18 |
| Specimen Types | 13-18 |
| Examples of Using Sample Design Codes | 13-21 |
| Length and Specimen Priority List for Bering Sea/Aleutian Islands Vessels | 13-24 |
| Length and Specimen Priority List for Gulf of Alaska Vessels | 13-27 |
| Length and Specimen Priority List for Plants and Floating Processors | 13-30 |

PRIORITIES

- Collect otolith specimens from randomly selected fish in your sex/length sample. If you are unable to collect both sex/lengths and otolith specimens, the otolith specimen takes precedence.
- Collect sex/lengths from species according to the Priority Lists at the end of this chapter starting on page 13-24.
- Collect sex/length/weight specimens from Bering Sea pollock and skates.

- Collect other specimen data according to the Priority Lists.
- Collect Sex/Length data from sharks encountered in species composition samples.
- Collect research project data.

INTRODUCTION

This chapter describes the methods for collecting sex/length and specimen data. Fish measurements and their

sex determination provide information on the abundance of fish in each size category. Specimen data collected from these fish give data users additional information to further assess and manage the resource. For instance, otolith and/or scale specimens provide corresponding age information. The age/length relationship of a species may change from year to year and may be quite different for each sex of a species.

Uses of Biological Data

Researchers and resource managers use the length, weight, and sex data you collect for age-length relationships (growth rate), length-weight relationships, sex composition and differences in growth between sexes. Your sex length data is also used to determine the abundance of year classes, the occurrence of year classes in commercial fisheries, and verification of the length data collected during research cruises by NMFS surveys.

Otolith specimens are collected by all observers. All observers are assigned to collect otolith specimens. Otoliths are read by agency staff to determine the age of the fish, then the age data are combined with the fish length and weight to provide length-age ratios. Sex/lengths collected also provide a picture of the abundance of each year class in the catch.

Sex/length, weight, and otolith collections provide information on the sex composition and the differences in the sizes of each sex in the catch. All of these components are used in the determination of the health of the stock and are applied in setting levels of sustainable yield. Commercial fishery quotas will be set, in part, based on sex/length data collected by observers from this and previous years.

COLLECTING FISH FOR SEX/LENGTH AND SPECIMEN DATA

For each haul, determine the sex and record the length of species listed on the Length and Specimen Priority Lists (lists begin on page 13-24). The Observer Program requests data from only those fish on the Priority List.

If you are aboard a catcher vessel delivering to a plant, sex/length data must be collected at sea so that it may be associated with a specific catch location.

Collect specimens from a subset of the measured fish on the Priority List. A variable number of "sex/lengths" and specimens will be collected per day depending upon the number of sampled hauls and composition of samples.

The rate of specimen collection will vary depending on which fishery you are in; refer to the Length and Specimen Priority lists beginning on page 13-24.

Below are guidelines for your sex/length measurement collections. It is important to collect sex/lengths from each sampled haul. If you are not able to measure the requested number of fish per haul measure as many as you can and document the situation in your logbook. Do not measure additional fish from other hauls to compensate for shortages in a given haul. Contact the Observer Program if the issue persists.

1. Before you begin collecting fish for sex/lengths, set up a work area to measure fish. You will need to have a space large enough to lay a fish on the plastic length strip. If there is no table available, use over turned baskets, deck bin boards or the deck for a table. The size of your measuring station will be a factor in how many fish you can collect at one time.
2. Determine the predominant species in your composition sample. This is determined by a visual assessment of the composition sample. Consult the Priority List for your collection protocols.
3. Devise a random method to collect fish for sex/lengths from the composition sample(s) based on the composition of the haul. Generally, the predominant species occurs in a high enough abundance that one randomly selected container, from one randomly selected sample will yield an adequate number of length fish. However, the abundance of secondary or tertiary species may be significantly lower within the species composition samples. This may require the selection of multiple samples within the haul in order to obtain the number of length fish requested on the Length and Specimen Priority List.
4. Determine the sex of all the measured fish except for halibut. If you cannot determine the sex of a fish, record the unsexed fish lengths with a "U" in the sex column on the Length and Specimen Form or in ATLAS.
5. If time is the limiting factor that determines how many sex/lengths you can collect, it is always preferred that you use the time you have to collect fewer sex/lengths rather than more unsexed lengths.
6. Sex/lengths and specimen data can be taken at the sample, subsample, haul, or offload level. These

data are recorded at the level from which they were collected. For example:

- sex/lengths taken from species within a composition sample are reported under that sample number,
- sex/lengths taken from salmon during an offload are reported under that offload number,
- unsexed lengths collected during a haul from halibut outside the species composition samples are reported under that haul number.

While you will collect the majority of sex/length and specimen data at the sample level, it is important to recognize that data may be entered at these other levels as well. For example, halibut injury assessments are usually collected outside the sample and recorded at the haul level. See “Sampling for Lengths and Specimens” on page 12-2 for instructions regarding the appropriate sampling level for prohibited species.

7. The collection of sex/length data has the potential to negatively affect a large portion of the value of the catch. This issue is of special concern in high value fisheries such as the Sablefish fishery. To minimize this issue you should always communicate your data collection needs to the captain. If a concern is raised about the collection of these data you should follow the guidance outlined on 13-11 of this section. Inform Observer Program staff as soon as possible if you experience difficulties.

If you are restricted from cutting fish to sex, you should collect fish for lengths as prescribed on the Length and Specimen Priority Lists and determine the sex of as many fish as the vessel agreed for you to cut. The sex/length fish must be randomly chosen as a subset of the measured fish. Fish that were not sexed will be recorded with a sex code of unknown.

SELECTION OF SPECIES FOR SPECIMEN SAMPLES

Determining the Predominant Species

You will be collecting sex/length and specimen data from the predominant species in your composition sample. *The predominant species is determined by your visual estimate.* You can choose to use a visually estimated count or a weight estimate to make this determination. You do

not need specific weights or numbers of organisms to determine which species is predominant.

Once you determine the predominant species in the sample, refer to the Length and Specimen Priority Lists for additional species from which to collect sex/length and specimen data. Select only species that are listed on the Length and Specimen Priority Lists (lists begin on page 13-24). The number of fish to select for your sex/length and specimen collections will vary depending on the predominant species and where the vessel fished. Consult this list for the appropriate number of specimens to collect.

These data must be clearly labeled with the name of the species they are associated to on your deck form.

Using the Sex/Length Priority Lists

To determine which species to select for sex/lengths and specimen collections refer to the following guidelines:

- First determine if your vessel is fishing in the BSAI or GOA, then determine if your predominant species is listed on the Length and Specimen Priority Lists for that region.
- Determine the predominant species in your randomly selected composition sample. This is determined by a visual assessment of the composition sample. Consult the Priority Lists for your collection protocols.
- For flatfish and rockfish predominant hauls, initial assessment should be made by the species group, then collect fish from the predominant species within that group. Collect only from those species that are in the Species Ranking List. For example, in a composition sample there are more Pacific Cod than any other individual species, but the 5 species of flatfish when combined are in greater abundance than the Pacific Cod. In this scenario you will go to the flatfish field on the Priority Lists for your sex/length selections.
- *If the predominant species in the catch is not on the list, do not collect sex/length and specimen data for that species.* Move to the next most predominant species in the catch that is on the Priority List.
- *If your vessel is fishing Halibut IFQ in State waters and Sablefish is the predominant species, do not collect sexed lengths or otoliths from Sablefish.* Instead, choose the next most predominant species as specified in the Length & Specimen Priority List.

- If there are species of equal predominance, select the one with highest priority.
- If two predominant species occur roughly in the same proportions in the catch, and are listed at the same priority, alternate between these species from haul to haul.
- In the flatfish and rockfish fisheries collect sex/ length and specimen data from the predominant, second, and third (if applicable) most predominant species using the Length and Specimen Priority Lists. If the secondary or tertiary species occur in equal proportions, select the species listed higher on the Priority List.
- Once the predominant collection has taken place remember to collect sex/length data from the other species listed with that predominant species on the Priority list. These must also be randomly selected from the entire composition sample (usually from the same sample).



If rock soles are the predominant species, collect a subset sample for species identification and use the identified fish for sex/length and specimen data (see "Subset Sampling" on page 2-27). These species must be recorded in your species composition data as well!

The species measured will change when species composition changes. For example, Pacific Cod may be the predominant species for the first two sampled hauls of the day, but the third sampled haul may contain a large amount of Sablefish. In this situation, the Priority List instructs you to measure approximately 20 Pacific Cod, approximately 10 Shortraker/Rougheye, and approximately 5 skates of any species from each of the first two sampled hauls, and measure approximately 20 Sablefish, approximately 10 Shortraker/Rougheye, and approximately 5 Giant Grenadier from the third sampled haul.



Collect sex/length and specimen fish from inside your species composition sample prior to sorting it! Ensure your collection does not have a size bias.

Collecting Sex/Lengths and Specimen Data from a Haul

The population from which sex/length fish are collected can be all the fish in the entire haul, offload, sample or

subsample. In the majority of the case, the population will be all the fish in the sample. Because the population is all the fish in a sample, a species composition sample may have been collected opportunistically but the sex/lengths are still randomly collected from within that sample and should be coded as such.

For each sampled haul, you may randomly choose one sample from which to take sex/lengths. If you are taking sex/lengths from two or more species, you may collect both species from within the same sample, or you may divide up the species over two or more samples. *The only requirement is that the sample or samples be randomly chosen and the fish from within the sample(s) are randomly selected.*

Assess your randomly selected sample to determine the predominant species. Always collect sex/lengths from unsorted catch within your composition sample. Sorting of the sample before randomly selecting your sex/length fish may introduce a size bias trend to the population (i.e. sorting larger fish into a basket and filling it then placing smaller fish into the next basket, and so on).

Avoiding Size Bias/ Hand Selection

It is important to measure fish collected from unsorted catch using a non-size selective method. Watch how fish are sorted, dumped, and moved to ensure no mechanical bias exists. If you suspect that there is bias affecting your samples, contact Observer Program staff immediately and work with them to modify and improve your sampling process before proceeding!

Once you have addressed vessel operation biases, determine how you will select fish for sex/lengths. *You must never use a shovel, gaff, or your hand, to select the fish* as these may be size restrictive and may dictate the size of the fish you are selecting. Once you have designated your sex/length fish within the composition sample you may use these tools to move fish to a suitable work area.

After devising an unbiased method to select the individuals to measure, evaluate the layout of the vessel (deck, factory, etc.) and the actions of the crew to identify tools you can use to collect your fish and minimize bias. For example, if there is a diverter board or a belt that can reverse the flow of fish into a basket, utilize those tools. Ask the crew for help in getting all the fish you selected. If an individual fish selected falls back on an incline conveyor belt, ask a crewman to grab it or push it up, ask rollermen to gaff aboard those fish selected on

longliners, or ask sorters not to pull out the large fish until you have your sample.

| Frequently Asked Questions |
|---|
| <p>Q: Which observers on which vessels collect sex/length data? A: <i>ALL</i> observers on <i>ALL</i> vessels and at <i>ALL</i> plants collect sex/length data.</p> |
| <p>Q: Which species should be sampled for sex/length data? A: The predominant species listed on the Length and Specimen Priority List. <i>Only measure species on the list.</i> If there are predominant species of equal proportions, select the species listed highest on the Priority List. If there are several hauls in a row with predominant species in roughly equal proportions and with the same priority, alternate between these species.</p> |
| <p>Q: How many fish are to be selected for sex/length data? A: Depends on the species, but on average you should measure approximately 20 fish per sampled haul. Reference the Length and Specimen Priority Lists.</p> |
| <p>Q: How should fish be selected for sex/length data? A: One possible method would be to randomly select a basket(s) of unsorted catch, then measure all of the fish in the basket(s). It is preferable to use the composition samples or subsamples for predominant species sex/length data. When you do this, resource managers benefit from data reported at the sample level. See page 13-5 for selection methods.</p> |
| <p>Q: Which fish should be sexed? A: Determine the sex of all the fish measured except for halibut. If you cannot determine the sex all the fish, sex a random subset of the measured fish.</p> |

Figure 13-1: Length Sampling FAQ

Suggested Random Methods for Collecting Fish for Sex/Lengths and Specimen Data

The easiest way to collect fish for sex/length and specimen samples is to randomly select one or more containers of unsorted fish from one of your species composition samples, then measure all individuals of the selected species in the container(s). If you are sampling large portions of catch, randomly collect a basket of *unsorted* catch. Use the selected species in this basket for your sex/

length and specimen samples, or if there are too many of the selected species in the unsorted basket, use a random design to further reduce the population.

- **Basket Dump Method:** *The basket dump method works well on most vessels and in most fisheries as a method to randomly reduce a population.* Once you have randomly selected a basket of unsorted catch from your species composition sample, split your selected basket by dumping it into two empty containers lined up next to each other. Assign numbers to the two empty baskets before dumping. After dumping the basket, randomly select one of these two containers and use all the predominant species in the randomly selected basket for your sex/length and specimen fish. You might end up with a few more or a few less fish than the number listed on the Length and Specimen Priority List. The numbers of fish listed in the Length and Specimen Priority Lists are guidelines! ***Do not bias your collection by attempting to obtain the exact number listed on the priority list.***

- **Grid Method:** This method may be used when your species composition sample is in a bin, tote, sorting table, etc. You can divide the bin into sections (halves, quarters, size of your baskets, bin boards, etc.). Randomly select a section or sections to collect your sex/length and specimen fish. However you decide to break up your population into units (sections of fish), your method must be repeatable, definable, and collected in a manner where no size bias or hand selection is introduced. Document the method in your Daily Notes. ***Collect all the fish*** from your randomly selected section into a basket(s). If you have more fish than you need, use the basket dump method to reduce the number of fish. If fish are straddling several sections, have a rule that will make the design so that each fish will be selected in only one area. Using the location of the eye or head is a suggested method (if the head is in your selected section, collect the fish).

Trawl Vessels

On trawl vessels, sex/length and specimen data from the predominant species may not be collected outside the species composition sample. Halibut viabilities may be collected from within the species composition sample or from the haul, depending on vessel operations.

Longline Vessels

On longline vessels, sex/length and specimen fish typically come from your predominant species weight subsamples. For the non-predominant secondary and tertiary species collect fish from within your tally sample. Halibut measurements and injury assessments are collected at the haul level (outside your tally sample).

Pot Vessels

On pot vessels, sex/length and specimen fish will typically come from a randomly selected sample pot used for collecting predominant species weights. Halibut viabilities are collected from within your species composition sample.

You will have to determine which method works best for each vessel you work on. Do the best you can and make sure you document in detail your sampling designs and methods, as well as any problems you encountered.

MEASURING FISH

NMFS uses fork length as the preferred method for measuring most fish species (see exceptions on later pages). Fork length is measured from the tip of the snout or jaw (the most anterior) to the end of the middle rays of the caudal fin (see Figure 13-2).

You will be given plastic measuring strips marked in centimeter increments. The first line printed on the strip is 4.5 cm, and the space between that line and the next line represents a measurement of 5 cm. Check your plastic strip, on both sides, to ensure that the first line is really 4.5 cm. Sometimes the manufacturer has cut the strip incorrectly. Notice that the 10 centimeter increments are not marked with a number. That is so that you can offset the strip when measuring larger fish. *You must use the NMFS issued tape measure when offsetting the length strip.* See Figure 13-3. Alternative materials to the aluminum board may be used for doing measurements, but you must be able to nudge the snout against something. The plastic strip can be held down with binder clips, tape, or fish slime (rub the back of the strip on the fish and it will “glue” temporarily to the board).

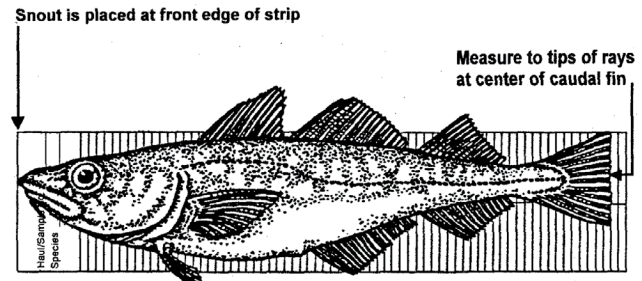

Figure 13-2: Measuring Fish

Steps to Measuring Fish

1. Position the plastic strip on the NMFS aluminum board. The labeled end should be toward the lip of the board.
2. Lay the fish flat on the plastic measuring strip directly on the center line.
3. Close the jaws. Align the fish snout against the lip of the aluminum board.
4. Fan out the caudal fin to find the middle rays (see Figure 13-2).
5. Record a tally mark on the length strip where the middle rays fall, or record the length directly on the Deck Form.



If the fork length falls on a printed line on the strip, try re-measuring the fish. If the length falls on the line again, use the lower centimeter measurement.

Measuring Large Fish

When measuring a fish that is larger than the plastic measuring strip you may use one of the following methods to accurately obtain its length (See Figure 13-3).

1. Offset the plastic strip by 10, 20, or 30 centimeters. *You must use the NMFS issued tape measure to offset the length strip.* Fill in the 10 centimeter increments accordingly.
2. Use two plastic measuring strips. Position the first one on the aluminum board flush against the metal lip. Place the second strip under the first one and line them up at a blank 10 centimeter space. Label the 10 centimeter increments accordingly.
3. Use the NMFS issued tape measure. Always measure

in a straight line, placing the tape under or next to the fish, not over it. Only use this method if you are unable to use the plastic measuring strips.

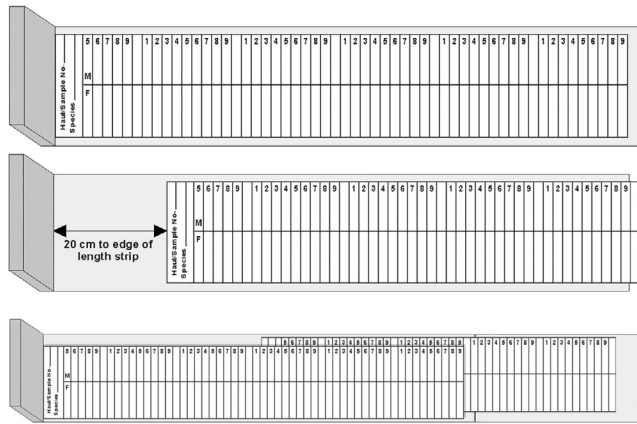

Figure 13-3: Measuring Strip Placement

It is preferred that you record the length directly onto the Deck Form to avoid transcription errors. Hand writing on the length strip can rub off and/or it may be made illegible by fish scales or slime. However, if you choose to write directly on the length strip, it should be cleaned with scouring powder to remove previous marks and make it ready for the next haul's lengths. Don't scrub too hard because you may scour off the centimeter lines! Be sure you have recorded your data on your Deck Form before you clean the length strip. Double check your transcribed lengths on your Deck Form against the length strip before cleaning the strip to make sure you recorded all the lengths correctly! It is always preferred that you use your length strip to obtain fish measurements. However, if you must use a tape measure be sure to follow these steps:

- Always lay the fish on the tape measure to avoid a curvilinear length.
- Round your measurement to the nearest cm using standard rounding rules *with an exception at 0.5cm in which you must round down*. For Example:
 1. A measurement of 85.6 cm would be recorded as 86 cm.
 2. A measurement of 85.4 cm would be recorded as 85 cm.
 3. A measurement of 85.5 cm should be repeated. If it

still falls on 85.5 cm, record as 85 cm.

These rules for using the tape measure are consistent with the length strip protocols.

Measuring Skates

The value you must document on the Length Form is the total length.

- The total length of a skate is defined as the length from the tip of the snout to the tip of the tail (with ventral surface of the skate down).

Identification of skates to species may require that you compare the individual's disk length (called precaudal length) to tail length ratio.

- *Precaudal length* is measured from the tip of the snout to the posterior aspect of the cloaca.
- *Tail length* is measured from the posterior aspect of the cloaca to the tip of the tail.

Measuring Giant Grenadier

The value you must document is the pre-anal fin length (PAFL) in cm. This is the measurement from the tip of the snout to the insertion of the first anal fin ray, immediately posterior to the anus. This is the standard because the long tapering tails of Giant Grenadiers are frequently broken off when they are caught.

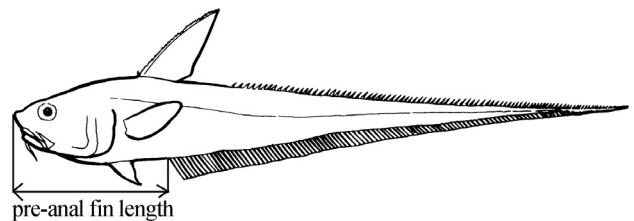

Measuring Sharks

The value you must document is the total natural length. Total natural length is the length from the tip of the snout to the posterior margin of the longest caudal-fin lobe (upper lobe) with the fin in its natural position.

When measuring sharks, safety is the first priority. Never attempt to obtain an actual measurement from a live shark. Always keep your hands away from the shark's mouth and be aware of unexpected movements.

Measuring Squid

The value you must document is the mantle length. It is a straight line measurement from the center edge of the mantle to the tip of the fin. Lay the ventral side of the squid on the length strip and align the tip of the fin to the edge of the strip.

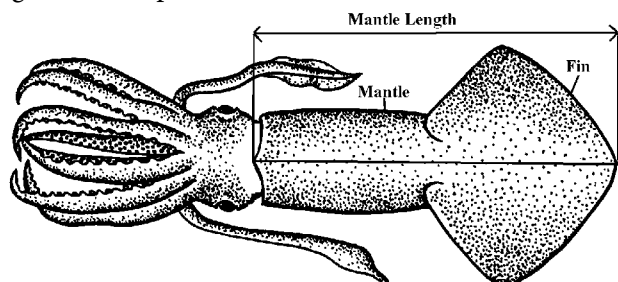

SPECIMEN COLLECTION RANDOM SAMPLE DESIGNS

The population from which specimens are selected is the fish collected for sex/length data. The sample unit is a single fish. You must use a random selection method that includes the entire population and each unit must have an equal opportunity of being selected. These are best collected using a simple random design.

OTOLITH SPECIMEN COLLECTION

Otolith specimens must be collected from a subset of fish used for sex/lengths. Depending on the number of otolith specimens needed for each species and the number of hauls you sample in a day, you may collect otolith specimens a few times per day, or only every few days. Use a systematic random sampling design, as outlined in the Length and Specimen Priority List, to determine the sampled hauls from which to collect otolith specimens.

For example: to collect otolith specimens from every 5th sampled haul, you would pick a random number between 1 and 5. Let's call this number q. You would then collect otoliths from the qth sampled haul, the q+5th sampled haul, the q+10th sampled haul, etc. If q= 4 then you would sample from the 4th, 9th, 14th, etc. sampled hauls until the predominant species changes or your cruise ends.

If you are unable to collect otoliths from your randomly selected haul for any reason, collect otolith specimens from the next sampled haul, and then continue with your original sequence.

Maintain the systematic design sequence even if you change vessels. For example, if you randomly chose haul 3 to begin taking pollock otolith specimens, and the vessel only fishes two hauls, you would take otolith specimens from the next sampled haul on your next vessel, providing it was fishing pollock.

| OBSERVER SAMPLING RECORD (OPTIONAL) | | | |
|--|-----------------------------------|------------------------|---------------------|
| VESSEL NAME: Aurora Borealis (Gulf of Alaska fishery) | | | |
| P. Cod otoliths every 5th sampled haul where Pacific Cod is the predominant species. | | | RN 1-5 = 3 |
| Haul# | Sampled (Y/N) | Species | Otoliths Haul (Y/N) |
| 1 | <i>Yes, will sample all hauls</i> | <i>Pacific Cod</i> | <i>N</i> |
| 2 | <i>Yes</i> | <i>Pacific Cod</i> | <i>N</i> |
| 3 | <i>Yes, first otolith haul</i> | <i>Pacific Cod</i> | <i>Y</i> |
| 4 | <i>Yes</i> | <i>Pacific Cod(1)</i> | <i>N</i> |
| 5 | <i>Yes</i> | <i>N/S rock sole</i> | <i>N</i> |
| 6 | <i>Yes</i> | <i>POP</i> | <i>Y</i> |
| 7 | <i>Yes</i> | <i>Pacific Cod (2)</i> | <i>N</i> |
| 8 | <i>Yes</i> | <i>Pacific Cod (3)</i> | <i>N</i> |
| 9 | <i>Yes</i> | <i>Pacific Cod (4)</i> | <i>N</i> |
| 10 | <i>Yes, second otolith haul</i> | <i>Pacific Cod (5)</i> | <i>Y</i> |

Figure 13-4: Example of Tracking Otolith Collections When Predominant Species Changes

Otolith specimens must come from the sex/length sample. Otolith specimens are a higher priority than sex/lengths and there may be times when you can only collect otolith specimens. Record your otolith specimens on your Deck Form.

Tracking Your Otolith Collection

It may be difficult to track when to collect otolith specimens, especially if the predominant species the vessel is catching changes often. One way to determine when to collect otolith specimens is to use the Observer Sampling Record in your logbook (see Figure 13-4 on page 13-8). Enter the haul numbers, whether the haul was sampled or not, and the predominant species that you measured for each haul. Determine the hauls from which you will be collecting otolith specimens by reviewing this chart.

Selecting Fish for Otolith Specimens

Collect otolith specimens from the selected sampled haul using a random method. Never use a haphazard method or hand pick your fish. Every fish selected for sex/lengths must have an equal opportunity of being selected as an otolith specimen. *Do not, under any circumstances, select fish for otolith specimens according to your perception of the size distribution you “should” be getting.* Use the techniques outlined below to avoid size bias.

The simplest and most preferred random selection method is to line up and number your sex/length fish from one to the total number, then randomly pick numbers within this range to identify fish from which to collect otolith specimens. This simple random (SRS) method will result in the exact number of desired fish for your specimen collection. If you find that another selection method works best for you contact your inseason advisor.

Example: After collecting your sex/length fish, you line them up and count that there are 22 fish. Each of the sex/length fish is assigned a number 1 through 22. Using the Random Number Table you select three numbers using a simple random method. The randomly selected numbers are 01, 20, and 12. You then pick up fish number 1, 12, and 20 from which to collect otolith specimens.

You are fishing in the Gulf of Alaska and have selected the third sampled flatfish haul to be your first otolith collection for flatfish. You assess your sample to determine the predominant species and it looks like rock sole and Flathead Sole occur in equal amounts. Since rock sole are ranked higher on the flatfish Species Ranking List, you randomly collect approximately 20 rock sole. Five of these fish are randomly selected and set aside for otolith and sexed/length/weight specimens. You will identify all 20 of the rock sole as either Northern or Southern Rock Sole while you measure and determine the sex of each individual.

Figure 13-5: Sex/Length Fish Selection Example

Otoliths From Tagged Fish

If the tagged fish was a randomly selected otolith specimen, the otoliths should stay with the data set and not be included with the tag. Otoliths from tagged fish that are found outside of your sample do not get entered into ATLAS. Otoliths from tagged fish outside your sample are attached to the Tagged Fish Form (see Figure 15-1 on page 15-5) and turned in at debriefing with the form.

Aleutian Islands Pollock Fishery

This fishery is conducted in NMFS reporting Areas 541, 542 and 543. These areas are in waters West of 170 degrees longitude and South of 55 degrees latitude in the Aleutian Islands Sub-Area. Only a small number of vessels participate in this fishery. Fishing in this region is noted in the vessel logbook. With the limited amount of coverage that occurs in such a small fishery you are asked to collect 75 sex/lengths and 10 pairs of otolith specimens per sampled haul.

How to Collect Otoliths

After obtaining the sex and length measurement, weigh the fish. Weigh fish for otolith collections on the brass 2 kg or 12 kg scales, or your motion compensated platform scale. Do not use the 50 kg Salter scale for individual fish weights unless the fish is over 12 kg and you do not have access to a motion compensated platform scale! Record weight, sex, length and the vial number in which the otoliths are placed on your Deck Form next to the specimen number. It is important that the numbered vials match the data for that fish. The data cannot be used if there is an error in the number used to correlate the otolith specimen to associated biological data.

Lead and second observers collect otolith specimens as one collection. All otolith specimens from both observers should be listed under the lead observer's cruise number. The lead observer is responsible for returning all data and specimens to debriefing.



Keep your otolith vials separate for each species and vessel! This will save you from trying to sort them out during debriefing!

Otoliths are fragile and must be in good condition to be read. During a non-otolith haul, practice taking otoliths from different species and different size fish. Try a variety of cuts and knife sizes until you feel comfortable. Since these will only be practice fish, the otoliths should not be kept or recorded on any forms.

If you have cut to the correct point, the otolith cavities (one on each side of the brain) will break open and expose the white, calcareous otoliths. They can easily be picked out with forceps. The otoliths **must** be wiped clean before storage in the vials or they will rot and become useless!



Figure 13-6: Location of Roundfish Otoliths

The otoliths are located on either side of the cranial midline just ventral to the brain tissue. The common methods of cutting into a fish's head to remove the pair of otoliths are:

1. A vertical cut through the head above the preoperculum, or
2. A horizontal cut through the head just above the eyes.

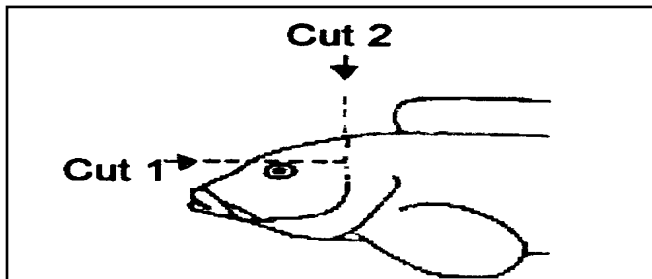

Step 1: Make a horizontal cut passing above the eye and through to the preoperculum. Then slice downward above the preoperculum and until the cuts meet.

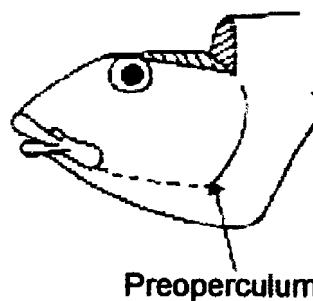

Step 2: Remove the top of the head. You should see the brain.

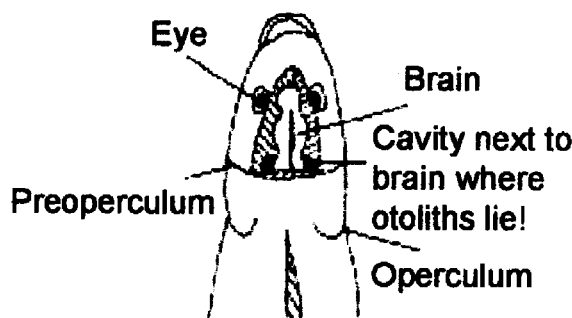

Step 3: The otoliths are in cavities under and to either side of the brain. Lift the brain tissue up and out of your way. The otoliths should lie right underneath.

Figure 13-7: The Horizontal Cut for Otolith Removal

The easiest method to use for most fish is to make a vertical cut down through the top of the head to the location of the otolith pocket. This point is located by a simple rule of thumb: imagine the two points on either side of the fish's head where, if the lateral lines were extended, they would meet the pre-opercular bones. Plan to cut down to these points. Species with tiny otoliths are best cut using the horizontal technique (see Figure 13-7).

Firmly grasp the fish by putting thumb and forefinger into the eye sockets or grasp the fish just behind the head, holding it dorsal side up. Bear down on the knife with even pressure as you cut through the bone of the head. Pay attention to the amount of pressure you are required to apply to make this cut. As soon as the cutting gets easier, ease off pressure on the knife or you will slice through the otoliths. Break the head open with two hands.

Carefully clean the otoliths by rubbing them between your fingers in water, or on a wet sponge or cloth to remove slime and tissue. Dry them as much as possible and place one pair of otoliths in each vial. *It is important to get the otoliths as clean and dry as possible before storing them to prevent them from rotting.* At the end of the collection period, transfer the data from the Deck Form to the Length and Specimen Form in ATLAS.



Otolith vials should not be filled with any solution prior to debriefing.

Collecting Otoliths from Atka Mackerel and Sablefish

Sablefish and Atka Mackerel have very small otoliths. Use a horizontal cut method when working with these species. To collect otoliths using the horizontal cut, hold the fish's head and make a horizontal slice into the snout just above the eye. Stop slicing when the knife is just anterior to the pre-opercle. Make a second cut down into the head until you reach the level of the first cut. Remove the wedge of head (see Figure 13-7). If you have made the cut correctly, there should be no blood flooding the cavity and you should see the brain tissue. The otoliths are just under and beside the brain. Grasp the brain tissue with forceps and pull it out or peel it back from the cavity. On either side of the brain cavity there is a fluid-filled pocket containing an otolith. The otoliths may not be visible yet, but if you insert forceps into the pockets, you will find the bony structures floating within the fluid. If blood fills the cavity, you have cut too deep, and the otoliths may be washed out. It's a good idea to practice this cut. When perfected, otolith collection is relatively easy.

Broken Otoliths

Some otoliths may break or be cut accidentally during your collection. Keep samples where one or both otoliths have a single clean break and all the pieces are retained. Discard samples with a shattered otolith or with only

one otolith. Do not replace the sample by taking otoliths from another fish in that haul.

If three or more otolith specimens from one species are lost or discarded collect otoliths from the next sampled haul, and then continue with your original sequence. Document the circumstances in your logbook. If you find you are consistently breaking otoliths, contact an Observer Program office for advice.

If You Run Out of Otolith Vials

The following steps need to be followed if you run out of otolith vials while you are deployed:

1. Continue to collect otoliths.
2. Wrap each otolith pair in a small piece of foil or paper after properly cleaning the otoliths.
3. Use a numbering system to identify which otoliths belongs to which fish specimen.
4. Record all the information on the Length and Specimen Form or in ATLAS except for the otoliths and the associated barcode number. For example, if you collect otoliths from a Northern Rockfish and run out of vials, you need to record the sex/length/weight specimen on the Length and Specimen Form. Once you transfer the wrapped otoliths to vials, you can go back and enter the otolith specimen and the associated bar code number.
5. Do not enter any false barcode numbers on the Length and Specimen Form or in ATLAS. This will be done once you get otolith vials for the otoliths.

SEX DETERMINATION OF FISH

After you collect fish according to protocols described in the section "Collecting Fish for Sex/Length and Specimen Data" on page 13-2, measure and determine their sex. Refer to your Species ID Manual for descriptions of and photos for determining the sex of several species and species groups. Sex/lengths must be recorded together as a group by sex on the Deck Form, and on the Length and Specimen Form in ATLAS.

Regulatory Support for Cutting Fish to Obtain Sex Data

Determining the sex of the species provides essential data for managing the fishery. Because of its importance,

regulations specifically support observers in cutting fish for sex/lengths. 50 CFR 679.51(e)(1)(viii) states that the vessel must, “Provide all other reasonable assistance to enable observers to carry out their duties, including, but not limited to: (E) Allowing the observers to determine the sex of fish when this procedure will not decrease the value of a significant portion of the catch.” In certain fisheries due to resources becoming more limited, the crew may be apprehensive about observers cutting certain species. If you encounter any resistance to these regulations you will be asked to complete a written statement on the matter in debriefing. Be prepared with detailed daily notes of the conversations you had with the crew regarding this matter.

Alternatives to Cutting Fish to Determine Sex

The crew may not want you to cut the fish because the cut will destroy or reduce the value of the product. Alternative methods to cutting fish can reduce the impact these data collections have on the industry and avoid causing unnecessary damage to the product. The only alternatives to cutting all of the measured fish are as follows:

- If the fish are spawning, squeeze the abdomen of the fish. If milt or eggs are present the sex can be determined. If nothing comes out do not use this method to determine the sex of the individual.
- If the target is Yellowfin Sole, you can determine the sex of mature yellowfin by “candling” them without cutting the flesh. Hold the fish up to a strong light and look through the blind side to see the gonad. Immature fish must be cut to discern sex. *This method can be used for yellowfin only!*
- Ask if a “pectoral cut” would be acceptable (slicing the throat area just under the pectorals across the body, the same way as the crew heads the fish by hand or machine). The gonads can be seen in the opened cavity or pulled out to examine. If this method is used for Sablefish, you must carefully examine the gonads to ensure you correctly determine the sex of the fish.
- If the target is Pacific Cod, when possible, cut the fish open using an abdomen/”belly” cut. This can be accomplished by inserting the point of your knife into the anus and cutting forward, towards the isthmus.
- If the target is flatfish, make a very small cut, parallel to the anal spine, about an inch behind the anal spine

and check the gonad (make sure you try this technique in the training or briefing session to see how it is used). The small cut may not be a problem for the product.

- If the crew is worried about you damaging the product, ask the crew to cut the fish for you.
- If there is no other way to determine the sex of the fish without cutting them, work with the captain to determine a number that you can cut, and list the rest as unsexed.

For example: The Captain has agreed to let you cut only 5 Sablefish per haul to determine the sex. You will randomly collect ~20 Sablefish during your subsample. From these 20 Sablefish you will randomly select 5 to determine the sex. Randomly select 3 of the 5 to collect otolith specimens from. The remaining 15 you will measure and record as unsexed lengths.

- If the vessel refuses to allow you to cut any of the fish because it would destroy a major percentage of the target species product or if product is whole or live fish, record all measured fish as unsexed. Notify NMFS and document the reasons in your logbook.

Sex Determination of Sharks

Similar to skates, the sex of a shark can be easily determined by noting the presence or absence of claspers. Claspers are paired reproductive structures located between the pelvic fins and anal fin. In mature males the claspers are large, rigid and easily distinguished. In immature males the claspers are smaller and flexible and may be harder to distinguish. In females, claspers are absent.

OTHER LENGTH AND/OR SPECIMEN COLLECTIONS

Pacific Cod and Pollock Maturity Scan Data

Observers collecting otolith specimens from Pacific Cod or pollock must also collect visual maturity stage data from female specimens. Visual maturity keys for each species are provided to assist you in assigning fish to one of six maturity stages based on visual examination of the ovaries. The keys are designed to track the visual changes in three characteristics of the ovaries that occur with reproductive development: size, coloration, and consistency (or texture). Researchers recognize that

there is subjectivity in assigning categories based on visual examination but find the data to be accurate when observers consider these three characteristics.

Methods:

1. Determine the sex of the fish (take care not to damage the internal organs).
2. If the fish is female, evaluate the maturity stage by comparing the visual characteristics of the ovary and oocytes to the species appropriate key provided in the Species Identification Manual. Ensure that you use the correct key.
3. Collect the otoliths.

Recording Data:

1. All data must be recorded on your Deck Forms.
2. Otolith, maturity scan (for female fish), and sex/length/weight specimens from one fish must have the same specimen number.
3. Use code 7 - “Maturity Scan” when entering data to the Length and Specimen Form and in ATLAS.

GOA Skate Age and Maturity Collection

Information on the age, growth, and maturity of two of the most common species of skate in the Gulf of Alaska, Big Skate (*Raja binoculata*) and Longnose Skate (*Raja rhina*), is imperative for fisheries managers to understand aspects of skate reproductive biology and development for stock assessment.

General Instructions:

Collect total length, weight, sex, maturity stage, and small sections of vertebrae specimens. *The desired sampling effort is no more than 5 specimens from each of big and Longnose Skate per GOA vessel observer. Specimens are to be collected from skates selected for sex/lengths according to the Length and Specimen Priority List.* Collect specimens from the first 5 big and Longnose Skates encountered for your cruise, although collection at any time during the cruise is acceptable. Plant observers do not collect skate age and maturity data.

Collection Procedures:

1. Identify the skate to species.
2. Determine the sex of the skate. Males have two claspers along the medial edges of the pelvic fins. These are

very small in immature specimens, and become long and calcified as the animals mature. Females have no such structures. See the Species Identification Manual for more information on determining the sex of skates.

3. Record the total length in centimeters from the tip of the snout to the end of the tail with the skate laying flat. If the tail is damaged such that total length can't be measured, do not collect a specimen – choose another skate. See “Measuring Skates” on page 13-7 for more information on measuring skates.
4. Weigh the skate and record the weight to the nearest 0.1 kg. If the skate is too large to weigh use the appropriate “Skate Length to Weight Table” on page A-49.

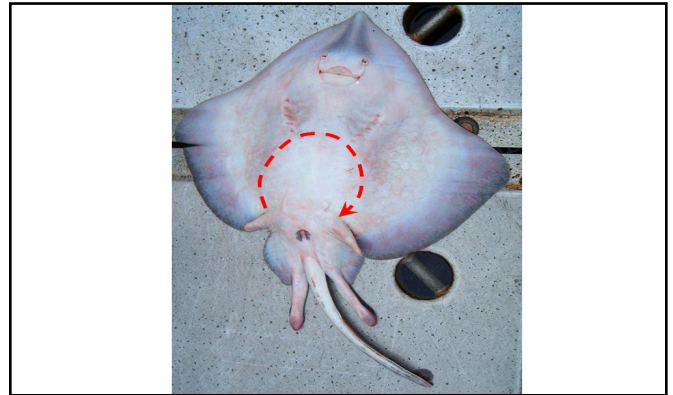

Figure 13-8: Skate Dissection for Maturity

5. Dissect the skate to determine the skate’s maturity stage:
 - Lay the skate on its back with the tail closest to you and cut the skin around the body cavity. It is easiest to start by cutting above one of the pelvic fins and make an upside-down “U” up toward the mouth and back down toward the other pelvic fin (see Figure 13-8).
 - The liver and gastrointestinal tract will most likely be the first things you see. You will have to cut these organs out to get to the gonads and vertebral column. The liver is a large, brownish organ with several lobes. The stomach and intestine can be traced by following the esophagus to the cloaca.
 - Take care when removing the gut, as sometimes the gonads are attached to it by connective tissue. The gonads are attached to the dorsal body wall and occur

as paired organs in both males and females.

6. Assign a maturity stage of 1, 2, or 3 based on the information below. See the Skate Maturity Stages images in your Species ID Manual to assist with maturity determination.

Male maturity stage is determined by examination of the claspers, testes and vas deferens. The vas deferens is a tube or duct that stores seminal products and is located on both sides of the skate's vertebral column (from a ventral view). It looks like a thin tube in the immature stage and enlarges and becomes convoluted upon sexual maturity.

- Stage 1- Claspers are very small and do not extend past the posterior edge of the pelvic fins. Testes are small and there is no coiling of the vas deferens. **Immature** (maturity scan code -1).
- Stage 2 - Claspers do extend past the pelvic fin edge but are still flexible. Testes are developing and there is some coiling of the vas deferens. **Developing** (maturity scan code -2).
- Stage 3 - Claspers are completely calcified (rigid) which allows them to mate successfully. Testes are large and differentiated with small lobes present over surface. The vas deferens is highly coiled. **Pre-Spawn** (maturity scan code -3).

Female maturity stages requires examination of internal structures:

- Stage 1 - The ovaries are small, homogeneous, and undifferentiated. **Immature** (maturity scan code - 1).
- Stage2 - Eggs are visible but are small and white. **Developing** (maturity scan code - 2).
- Stage 3 - The ovaries contain large eggs with yellow yolks. Egg cases may be present. **Pre-Spawn** (maturity scan code - 3).
- You can also look at the shell glands to determine female maturity stage. These paired organs are located at the top of the oviduct and are the site of both fertilization and secretion of the egg cases. They are just small swellings of the oviduct in juvenile skates and become wider but are still translucent in adolescents. In adults, they are large lima bean-shaped organs which are opaque and well-differentiated.

7. Remove a section of vertebrae:

- Remove the internal organs. You should be able to see the outline of the vertebral column along the back of the skate.
 - In the middle of the body cavity, make parallel incisions on either side of the vertebral column.
 - Cut transversely through the vertebral column to remove a rectangular piece of vertebral column containing at least 5 vertebrae.
 - Place the vertebrae sample in a plastic bag, with a completed Bag and Tag Specimen Collection Label, making sure the label can be read from the outside of the bag.
8. Preservation- Heavily salt the vertebrae samples to preserve them. (You should be able to obtain non-iodized table salt from the crew). If salt is not available, please freeze the samples. Frozen samples that thaw are still good to keep and should not be disposed of, simply refreeze as soon as possible to reduce the odor. NOTE: Very small skates (<30 cm TL) can be collected whole.

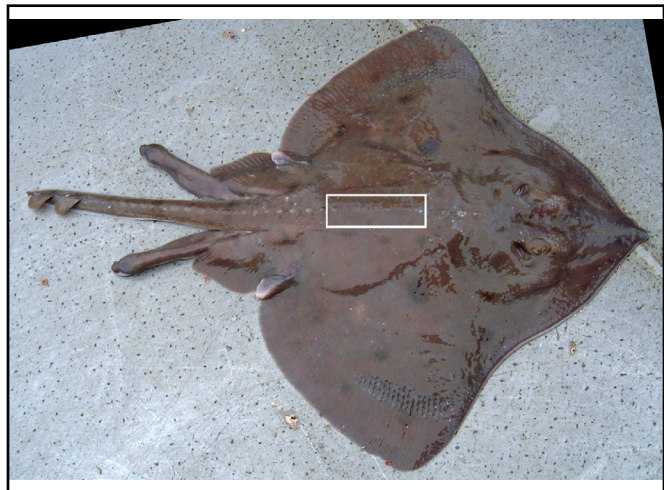

Figure 13-9: Skate Vertebrae Collection

Recording Skate Vertebrae Data

1. Record the sex, length, weight, and maturity information on the Deck Form.
2. Complete the Bag and Tag Specimen Collection Label. Mark "Other" under "Reason for Collection" and write "Vertebrae" in the comments field.

- Record the sex, length, weight, and maturity (using codes 1-3) information in Atlas.

Turning in Your Vertebrae Specimens

Bring salted or frozen samples to either the Kodiak or Dutch Harbor Field Office or to your debriefing. If you put bags of samples into a larger bag, please place a completed Bag and Tag Specimen Collection Label inside the larger bag to identify the collection and make sure the label is readable from the outside of the bag. Please refer to “Dropping Off Specimens” on page 2-15.

If you leave your samples behind on the vessel, they will likely be tossed and all your work will be lost.

| Bag and Tag Specimen Collection Label | | | | | | |
|---|------------------------------------|--------------------------------------|--|-----------------------------------|------------------------------------|---|
| Cruise | Permit | *Trip No. | Haul No. | Offload No. | Sample No. | S-Smpl No. |
| 19982 | 7891 | | 216 | | 1 | |
| Cruise No. If not collected by lead: | | | *location information for trip level collections | | | |
| Species Code: | 94 | Species Name: Big Skate | | | | |
| Reason for Collection | | | | | | |
| ID Verif. <input type="radio"/> | Out of Range <input type="radio"/> | Training Spec. <input type="radio"/> | Salmon Snout <input type="radio"/> | Mammal Part <input type="radio"/> | Bird Spec. <input type="radio"/> | Other Describe in Comments <input checked="" type="radio"/> |
| Comments: Vertebrae specimen collected | | | | | Specimen No. or Barcode 132 | |

Figure 13-10: Skate Vertebrae Label

Sturgeon

If you encounter a sturgeon at any point during your cruise, collect the following data:

- Sexed length and sex/length/weight. *If the fish is alive*, do not determine the sex, record as unknown. *If the fish is dead*, determine the sex and take a picture of the gonads
- Tags (if any are present)
- Fin clip (see instructions below),
- Photographs of the fish,

Record these data on the Deck Form and enter them in the Length Data Form in ATLAS.

Sturgeon fin clip collection instructions:

- Rinse the knife or scalpel profusely with water to

avoid contamination and wipe dry.

- Using the knife or scalpel and forceps, remove a 5 x 5 mm piece of anal or caudal fin. The tissue should come from a portion of the fin that appears clean and healthy, not frayed or broken.
- Place the fin clip in Whatman paper, and place in a scale envelope to dry. Wait 24 hours before sealing envelopes to ensure the tissue fully dries. Do not place envelopes in direct sun or intense heat.
- Do not store your samples where they might get wet or moist as this will ruin the specimens.

Salmon Genetics

Observers assigned to AFA pollock catcher processors, AFA motherships, all Gulf of Alaska vessels and all plants receiving Bering Sea pollock must complete Salmon Genetics Collections. These data are recorded on the Length and Specimen Form in ATLAS. See “Salmon Genetics Sampling” on page 12-13 for more information.

Shark Sex Length Data

The stock assessments for large shark species (excluding spiny dogfish) in Alaska is extremely data limited. There are three main concerns in the assessment for large shark species: accuracy of the catch estimates, size of the animals, and the vulnerability of the species. The collection of length data from large shark species will aid stock assessment scientists and fishery managers to better understand these important species and the impact of commercial fishing on their abundance and life cycle.



When measuring large shark species, safety is the number priority. Never attempt to obtain an actual measurement from a live shark. Always keep your hands away from the shark’s mouth and be aware of unexpected movements.

If you encounter a large shark species (excluding spiny dogfish) in your composition samples, including pre-sort samples, the sex should be determined and a measurement should be obtained if it is safe to do so. (See “Measuring Sharks” on page 13-7 and “Sex Determination of Sharks” on page 13-12). Only those sharks (excluding spiny dogfish) encountered in your composition sample and that are in hand should be measured. Record these data on the Deck Form and enter into the Length Data Form in ATLAS.

On long line vessels, do not direct the crew to bring large sharks onboard for the single purpose of obtaining sex/length data. If a large shark is brought on board for other reasons and the shark was encountered during the tally period, a measurement can be obtained and reported.

Do not enter estimated shark lengths in Length Data Form of ATLAS.

RESEARCH PROJECTS

Some observers will be required to collect additional research project data. Research project kits come with a separate project instruction packet. Refer to this for information on how to proceed with the project and what types of data to collect.

COMPLETING THE LENGTH AND SPECIMEN FORM

Length and specimen data are transferred directly from the Deck Form to the Length and Specimen Form in ATLAS. *Do not record estimated lengths on this form.* If you are not able to enter these data in ATLAS, contact the Observer Program, and if you are instructed to complete a Length and Specimen paper form, see Paper Form Instructions and examples on page 18-31.

Length data can be collected and recorded at the sample, haul, or offload level. In ATLAS and in the Observer Program database, specimens are child records of lengths (i.e., specimen data are dependent on length data), therefore length data must be entered before specimen data.

Sample Design

The sample design code captures the method that was used to select the sex/length fish from the composition sample, haul, or offload. The sample design code does not indicate how you selected specimen fish from your sex/length fish collection; this is defined by the specimen type. Enter the sample design code appropriate for your sex/length sample collection. The sample design codes for prohibited species must be assigned specifically to the sex of that prohibited crab or salmon species.



Ensure that your sex/length fish are collected randomly. Do not hand select fish or introduce any other size bias

Specimens from sex/length fish must have the same sample design code as the sex/length fish they were collected from and they must be listed with the sex/length fish from which they were selected (i.e., otolith fish and sex/length/weight fish).

Read all choices and/or use the flow charts to determine which is the most appropriate sample design for your sex/length sample collection method. For examples of using the sample design codes see page 13-20 and page 13-21. The following sample design codes apply specifically to sex/length data.

- **1-Stratified Opportunistic:** Stratified sample collections are those taken to accomplish a specific collection of a certain length and at a specific time. For example, if you were asked to collect lengths from 1200-1800 hours and from a species measuring between 40 and 50 cm, your collection would be a stratified opportunistic collection.
- **4-Size Selected:** Use for research project data when only certain size fish are needed. Use for stomach specimens collected from outside your randomly selected sex/length fish.
- **5-Opportunistic:** Sex/length samples taken without randomly preselecting when or where you are going to sample, or samples collected from the only accessible portion of the catch.
- **6-Simple Random:** Used for a basic simple random sample collection of fish. This is the default sample design code for sex/length and specimen fish in ATLAS. For example, use this design code when a random basket dump and the RNT are used to obtain sex/length fish.
- **7-Systematic Random:** Fish collected from a larger population using a systematic random design use this design code. For example, fish are selected from your composition sample for sex/lengths using the n+x method. Used for salmon genetics data collected on a AFA pollock catcher processor, AFA mothership, or at a shoreside/floating processor receiving Bering Sea pollock.
- **8-Stratified Random:** Not in use after 2009.
- **9-Other Random:** Samples collected using a random sample design scheme not described by the other random methods use this sample design code. Use

this code when you used more than one sample design to select your sex/length fish (e.g., you used a simple random method to select a basket from your composition sample, and then used a systematic method to select fish from the chosen basket). Use this code for sex/lengths taken from a long line subsample. If a research project requires a design that falls under this code, it will be noted in the instructions.

- **10-Census:** When your sex/lengths or specimens are collected from all individuals of a species/sex in the sample population. May be used for a particular species or several species when your sample is the entire haul, offload, or composition sample. Examples:

1. Use for sex/lengths when all individuals of the same sex crab or salmon species are collected from a species composition sample. When a species group code exists because of crab parts and all the whole crabs are measured, this is still considered a census.
2. Use in the Bering Sea flatfish fishery where the secondary species sex/lengths come from the only 3 Alaska Plaice present in your selected composition sample.
3. Use this design code for salmon sex/length and specimen collections from your Gulf of Alaska offload salmon retention count.
4. *This design code cannot be used for a species when the species group exists in the species composition sample.* For example, rock sole is the predominant species. You collect a subset, identify all of them to Northern Rock Sole, and each one is measured. Even though all the Northern Rock Sole were measured, it cannot be a census since the rock sole group code exists in the same sample.

- **11-Other:** Used for other sample designs that do not conform to the other design codes listed here. Document and contact the Observer Program.

- **12-Unknown:** Use when you are not sure of the sample design you are using. If you use this design code be sure to document the situation in your logbook so a determination of your sample methods can be made during debriefing. If you find that you are routinely using this code, contact the Observer Program staff for assistance.

- **14-Randomized Block Design:** This code is only used when documenting the collection of halibut deck sorting on non-pollock trawl and motherships. This code is associated with the use of the randomized block sample tables and deck sort pages provided. The tables provide a sequence of random numbers that dictate which unit within a specified sample block is selected

Sex: Record the fish or crab sex as “F” (female), “M” (male), or “U” (unsexed or uncertain).

Eggs?: This column is filled out only for *female prohibited species crab*. Enter “Y” in this column when eggs are present. Enter “N” for female crabs without eggs. Enter “U” for female crabs where the presence of eggs is unknown.

Viability and Injury

For all *trawl and pot* caught halibut viability assessments, list viability codes in this column. Use condition codes “E” (excellent), “P” (poor), “D” (dead), or “U” (condition not assessed). Trawl and pot halibut criteria conditions are different and can be found starting on page A-47. Skip a line between different viability codes.

For all longline caught halibut injury assessments, list the injury codes in this column. For more information, see page A-53. Use one of the following injury codes:

- 1 - Minor
- 2 - Moderate
- 3 - Severe
- 4 - Dead/Sand Fleas/Bleeding
- 9 - Unknown

Length

List the lengths you recorded on the Deck Form. List only size groups that have a frequency of one or more. *Lengths that contribute to specimen data must be circled on the Deck Form.* This allows you and others to easily verify that your data are entered completely.

Frequency

Frequency represents the number of animals in the particular length group. Length groups must be separated by species, haul or offload, sample or subsample number, sample design, sex, eggs yes/no, or viability/injury code.

Specimen Number

You are responsible for coming up with a numbering system that ensures each specimen number is unique for each fish within a cruise/permit. The easiest method would be to number the first fish you take specimens from as specimen number "1." The specimen numbering system should continue in ascending order for subsequent fish regardless of the species or specimen type.

Multiple specimens collected from the same fish are recorded using the same specimen number. For example, an otolith specimen collected from a female pollock will have a sex/length/weight specimen (code 3), an otolith specimen (code 1), and a maturity scan specimen (code 7) all entered with the same specimen number. See Deck Form examples starting on page 13-22.

If you are on a vessel with 2 observers, the second observer always follows the numbering sequence of the lead observer. Follow the numbering sequence of the plant observer if you are a vessel observer collecting specimens for the plant observer at a pollock offload.



Specimen numbers cannot be repeated for a cruise/permit regardless of the species. Specimen numbers must be documented on the Deck Form.

Weight

The sex/length/weight specimen (code 3) is the only specimen type that requires a weight entry. Weights must be listed to two decimal places for clarity of the faxed data.

Otolith Bar Code

Record the barcode number on the otolith vial for each pair of otolith specimens collected for that haul. Each vial number is unique and cannot be altered.

Maturity Scan codes: Record the maturity code from this list:

1. Immature
2. Developing
3. Pre-spawn*
4. Spawning*
5. Spent
6. Resting (Pacific Cod only)

**The stomach collection maturity scan uses only codes 3 (Pre-spawn) and 4 (Spawning).*

Currently, only the maturity scan specimen type requires a maturity scan code. This is used for the Pacific Cod and pollock maturity scan specimens and for stomach specimens only. Unless otherwise noted in a research project packet, this column should be left blank.

Specimen Types

All specimen fish should have an associated sex/length/weight specimen type (code 3).

- **1-Otoliths:** This code is used for otolith (ear bone) collections. Otoliths are placed in vials with a corresponding bar code number. Each bar code is unique and cannot be altered.
- **2-Scales:** Use for FMA ID salmon scale samples. Salmon scale envelopes (see "Scale Sample Protocols" on page 12-11) must be labeled with a specimen number and "FMA ID." FMA ID scales are recorded under the cruise number of the observer reporting the data.
- In the BS pollock fishery, follow the numbering sequence of the lead observer if you are the second assigned to a CP or plant.
- Follow the numbering sequence of the plant observer if you are a vessel observer collecting specimens for the plant observer at the pollock offload.
- **3-Sex/Length/Weight:** For each sex/length/ weight specimen, record a unique specimen number. Number your sex/length/weight specimens consecutively from the starting number.
- *All specimen types require a corresponding sex/length/weight specimen.* Only one sex/length/weight entry needs to be made for multiple specimens collected from the same fish.
- Pollock - On every otolith haul in the Bering Sea pollock fishery, weigh and measure a subset of the pollock from your sex/length sample that were not used for otolith specimens. Record the data on the Length and Specimen Form with a Specimen Type code 3 (Length/Weight). Do not use the same pollock for an otolith specimen and a sex/length/weight specimen.
- **4-Fin Clip:** This code is used for salmon genetics samples and for sturgeon collections.

- **5-Vertebrae:** This code is used for skate vertebrae samples.
- **7-Maturity Scan:** Used for a visual assessment of gonad maturity.
- Pacific Cod and Pollock - Record the maturity scan specimen as a third line of entry to the female otolith specimen data. Maturity stages are discussed in the Pacific Cod and pollock maturity code keys. Maturity Scan codes Pre-Spawn (code 3) and Spawning (code 4) are also used for stomach specimens.
- Skate Vertebrae - Record the maturity scan specimen as a third line of entry to the skate vertebrae specimen data. Maturity stages are discussed in the skate maturity code keys and on page 13-14. Maturity Scan codes Immature(code 1), Developing (code 2) and Pre-Spawn (code 3) are used for the skate vertebrae collection.
- Stomachs - Maturity Scan codes Pre-Spawn (code 3) and Spawning (code 4) are used for stomach specimen data. Record the maturity scan specimen as the third line of entry to the stomach specimen, using the same specimen number. See “Entering Stomach Collection Data in the Length and Specimen Form” on page 17-4 for specific instructions regarding stomach maturity data.
- **8-Maturity:** Currently used only for individually assigned research projects. This code is used when the ovary is collected and frozen.
- **10-Isotopes:** Currently used only for assigned research projects.
- **11-Other Tissue:** Currently used only for assigned research projects.
- **12-Snout:** Used for tagged salmon snouts. Specimen data are recorded as raw data on the Deck Form, then entered into ATLAS or onto the Length and Specimen Form. Refer to “Tagged Salmon” on page 13-15 for instructions on completing this specimen collection.
- **14-Stomach Contents:** Used for stomach collection data.
- **15-Photo:** Used for photo specimens. Currently only used in conjunction with stomach contents specimens.

Research Project Specimens: If completing a research project, refer to the project instructions accompanying the project kit for information on how to proceed with the project, what data to collect, and how/where to record it. Some projects will have project specific data forms and others will utilize the Length and Specimen Form or will be entered into ATLAS.

EXAMPLES OF USING SAMPLE DESIGN CODES (PART 1)

The following are examples of some common methods frequently used by observers to collect and select sex/length fish. There are many other collection methods not listed below. Refer to “Sample Design” on page 13-16 for detailed sample design code explanations. If you have questions about which code to use, contact your inseason advisor or Observer Program field staff. If you cannot determine which design code applies to your method, use Code 12 - Unknown and contact your inseason advisor or Observer Program field staff.

Opportunistic (Code 5):

1. On a *longliner*, the observer tallies six tanner crabs in their samples and five were landed (one dropped off). The observer identifies the crabs in the bycatch baskets as opiliois, and sex/lengths them all. The design code is opportunistic because one of the crabs dropped off, therefore all of the crabs could not be measured.
2. On a *longliner*, the observer decides to collect the first 5 skates from their tally sample for sex/lengths and tallies the rest that come upon the line. The sample design code is opportunistic because only the first 5 had the opportunity to be chosen for sex/lengths.
3. On a *catcher vessel*, the observer collects all the Flathead Sole in a species composition sample for sex/lengths and is unable to measure one because the caudal fin was torn. The sample design code is opportunistic since a random method was not employed to exclude that fish and not all of the Flathead Sole were measured.

Simple Random (Code 6):

1. On a *CP trawler*, the observer employs a Simple Random method to select 50 kg from their 10 metric ton sample as a point to collect a basket of fish for sex/lengths. The observer used the basket dump method to reduce the number of fish in the baskets to about 20 fish.
2. On a *trawler*, the observer randomly chooses a portion of the checker bin and collects *all* the fish for sex/lengths in that area.
3. On a *longliner*, the observer randomly chooses a non tally segment to collect halibut for sex/lengths and injury assessments. All the halibut are collected within the entire segment and used for injury assessments.
4. On a *trawler*, the observer employs a Simple Random method to choose a corner of the checker bin to collect fish for sex/lengths. All fish in that area whose snout points towards the corner are chosen for sex/lengths.

Systematic Random (Code 7):

1. This code is used for salmon genetics data collected on a *CP, mothership, or at a shoreside/floating processor*. Code 7 is used for genetic samples collected from your GOA offload salmon retention count.

Other Random (Code 9):

1. The observer uses a simple random method to select a basket from their sample, and then uses a systematic method to select fish from the chosen basket.
2. Use this code for sex/lengths taken from a longline subsample.

Figure 13-11: Examples of Using Sample Design Codes (Part 1 of 2)

EXAMPLES OF USING SAMPLE DESIGN CODES (PART 2)**Census (Code 10):**

1. On a *CP trawler* targeting pollock, the observer collects all the prohibited crab in a sample, identifies them to species, and collects sex/lengths on all of them.
2. On a *longliner*, the observer tallies a total of 5 skates in their sample, collects them all, identifies them to species and collects sex/lengths on all of them.
3. On a *flatfish vessel*, the observer needs to collect Alaska Plaice for his/her secondary lengths. The observer collects all the Alaska Plaice from his/her randomly chosen sample and collects sex/lengths on all of them.
4. On a *CV trawler*, the observer encounters 5 opilios and all of them are measured. Tanner crab legs were also found and entered with a number of 0 and a corresponding weight in their species composition sample. It is still considered a census since all the whole, intact tanner crab were measured.

Other (Code 11):

1. Use code 11 for other sample designs that do not conform to the other codes listed here. If you use this code be sure to document the circumstances in your logbook so a determination of your sample methods can be made during debriefing. If you routinely use this code, contact Observer Program staff for assistance.

Unknown (Code 12):

1. Use code 12 when you are not sure of the sample design you are using. If you use this code be sure to document the circumstances in your logbook so a determination of your sample methods can be made during debriefing. If you routinely use this code, contact Observer Program staff for assistance.

Figure 13-12: Examples of Using Sample Design Codes (Part 2 of 2)

DECK FORM

| | | | | | |
|---------|--------|--------|----------|-------------|--|
| Date | Cruise | Permit | Haul No. | Offload No. | Page <u>32</u> of _____ for Vessel/Plant |
| 8/31/23 | 23000 | 0529 | 216 | | Page <u>1</u> of _____ for Haul/Offload |

| | | | | |
|---------------------------------|--------------------------------|----------------------------|--|---|
| Sample #: <u>1</u> | Sub-Sample #: | Sample Size: <u>195.24</u> | <small>Kgs</small> Segments pots | # of Sampled Hooks: |
| Presorted <input type="radio"/> | Combined <input type="radio"/> | | | No Fish in Sample <input type="radio"/> |

| Species | Sex | # | Weight | % ret. | Length, viability, injury, specimen, tally data, measurements, bird observations, sample design, notes: | | | | | | | | | | | | | | | | | | | | | | |
|----------------------|------|----|--------|--------|---|---|---|------|------|------|------|------|------|------|------|------|------|------|------|------|------|---|---|--|------|--|------|
| ----- KEYPUNCH ----- | X | 52 | 195.24 | X | | | | | | | | | | | | | | | | | | | | | | | |
| P.Cod | | 9 | 47.90 | 100 | <p><u>PCod S/L</u></p> <table border="1" style="display: inline-table; margin-right: 20px;"> <tr><td style="text-align: center;">M</td><td style="text-align: center;">F</td></tr> <tr><td>58-1</td><td>59-L</td></tr> <tr><td>59-1</td><td>62-1</td></tr> <tr><td>62-L</td><td>63-1</td></tr> <tr><td>63-1</td><td>65-1</td></tr> <tr><td>67-L</td><td>66-1</td></tr> <tr><td>75-1</td><td>67-1</td></tr> <tr><td>76-1</td><td>73-L</td></tr> </table> <p><u>AK Skate S/L</u></p> <table border="1" style="display: inline-table;"> <tr><td style="text-align: center;">M</td><td style="text-align: center;">F</td></tr> <tr><td></td><td>65-1</td></tr> <tr><td></td><td>62-1</td></tr> </table> <div style="border: 1px solid black; padding: 5px; margin-top: 10px;"> <p>Create a sex/length tree for all s/l records. All s/l must be clearly labeled with the species name. Every s/l record must have a frequency tally mark.</p> </div> <p><u>Big Skates Vert</u></p> <p>sp# 152 M/69/6.8 Prespawn sp# 153 F/82/7.4 prespawn sp# 154 F/53/4.7 prespawn</p> | M | F | 58-1 | 59-L | 59-1 | 62-1 | 62-L | 63-1 | 63-1 | 65-1 | 67-L | 66-1 | 75-1 | 67-1 | 76-1 | 73-L | M | F | | 65-1 | | 62-1 |
| M | F | | | | | | | | | | | | | | | | | | | | | | | | | | |
| 58-1 | 59-L | | | | | | | | | | | | | | | | | | | | | | | | | | |
| 59-1 | 62-1 | | | | | | | | | | | | | | | | | | | | | | | | | | |
| 62-L | 63-1 | | | | | | | | | | | | | | | | | | | | | | | | | | |
| 63-1 | 65-1 | | | | | | | | | | | | | | | | | | | | | | | | | | |
| 67-L | 66-1 | | | | | | | | | | | | | | | | | | | | | | | | | | |
| 75-1 | 67-1 | | | | | | | | | | | | | | | | | | | | | | | | | | |
| 76-1 | 73-L | | | | | | | | | | | | | | | | | | | | | | | | | | |
| M | F | | | | | | | | | | | | | | | | | | | | | | | | | | |
| | 65-1 | | | | | | | | | | | | | | | | | | | | | | | | | | |
| | 62-1 | | | | | | | | | | | | | | | | | | | | | | | | | | |
| P.Cod | | 5 | 23.50 | 100 | | | | | | | | | | | | | | | | | | | | | | | |
| P.Cod | | 7 | 28.42 | 100 | | | | | | | | | | | | | | | | | | | | | | | |
| AK skate | | 7 | 46.80 | 0 | | | | | | | | | | | | | | | | | | | | | | | |
| Pollock | | 4 | 6.00 | 100 | | | | | | | | | | | | | | | | | | | | | | | |
| Arrowtooth | | 2 | 3.82 | 0 | | | | | | | | | | | | | | | | | | | | | | | |
| Big Skate | | 3 | 18.45 | 100 | | | | | | | | | | | | | | | | | | | | | | | |
| Halibut | | 8 | 16.80 | 0 | | | | | | | | | | | | | | | | | | | | | | | |
| Yellowfin sole | | 3 | 1.45 | 0 | | | | | | | | | | | | | | | | | | | | | | | |
| Flathead Sole | | 4 | 2.10 | 0 | | | | | | | | | | | | | | | | | | | | | | | |

Additional biological data must be clearly labeled with species name and specimen type.

| | | | |
|---------------------------------|--------------------------------|--|---|
| Sample #: | Sample Size: | <small>Kgs</small> Segments pots | # of Sampled Hooks: |
| Presorted <input type="radio"/> | Combined <input type="radio"/> | | No Fish in Sample <input type="radio"/> |

| Species | Sex | # | Weight | % ret. | Length, viability, injury, specimen, tally data, measurements, bird observations, sample design, notes: |
|----------------------|-----|---|--------|--------|--|
| ----- KEYPUNCH ----- | X | | | X | |
| | | | | | <p><u>Halibut L/viabilities (sample 1)</u></p> <p>55-P 51-D 56-P 54-P 55-E 60-E 52-E 58-E</p> |
| | | | | | |
| | | | | | |
| | | | | | |
| | | | | | |
| | | | | | |
| | | | | | |
| | | | | | |
| | | | | | |
| | | | | | |

Tally K/P

Ver. 2016

Figure 13-13: Deck Form Example Showing S/L and biological raw data documentation on a GOA P. Cod Catcher Vessel

DECK FORM

| | | | | | |
|----------|--------|--------|----------|-------------|--|
| Date | Cruise | Permit | Haul No. | Offload No. | Page <u>56</u> of _____ for Vessel/Plant |
| 12/01/23 | 28500 | 1965 | 489 | | Page <u>1</u> of _____ for Haul/Offload |

| | | | | |
|---------------------------------|--------------------------------|----------------------------|--|---|
| Sample #: <u>1</u> | Sub-Sample #: | Sample Size: <u>128.16</u> | <small>Kgs Segments pots</small> | # of Sampled Hooks: |
| Presorted <input type="radio"/> | Combined <input type="radio"/> | | | No Fish in Sample <input type="radio"/> |

| Species | Sex | # | Weight | % ret. | Length, viability, injury, specimen, tally data, measurements, bird observations, sample design, notes: | | | | | | | | | | | | | | | | | | | | | | |
|---|--------|-----|--------|--------|--|---|------|--------|------|--------|--------|--------|--------|------|------|--------|--------|--------|------|--------|--------|---|------|------|--------|--------|---|
| ----- KEYPUNCH ----- | X | 155 | 128.16 | X | | | | | | | | | | | | | | | | | | | | | | | |
| Pollock | | 36 | 28.20 | 100 | <p><u>Pollock S/L</u></p> <table style="width: 100%; border: none;"> <tr> <td style="width: 50%; border: none;"> <table style="width: 100%; border: none;"> <tr><td style="width: 50%; border: none;">M</td><td style="width: 50%; border: none;">F</td></tr> <tr><td style="border: none;">42-1</td><td style="border: none;">(36)-1</td></tr> <tr><td style="border: none;">(43)-1</td><td style="border: none;">39-1</td></tr> <tr><td style="border: none;">(45)-L</td><td style="border: none;">41-1</td></tr> <tr><td style="border: none;">46-1</td><td style="border: none;">(42)-L</td></tr> <tr><td style="border: none;">(47)-L</td><td style="border: none;">(44)-1</td></tr> <tr><td style="border: none;">48-1</td><td style="border: none;">46-1</td></tr> <tr><td style="border: none;">(49)-1</td><td style="border: none;">48-1</td></tr> <tr><td style="border: none;">53-1</td><td style="border: none;">49-1</td></tr> <tr><td style="border: none;">(58)-L</td><td style="border: none;">(55)-1</td></tr> </table> </td> <td style="width: 50%; border: none;"> <p><u>Pollock S/L/W</u></p> <p>sp# 974-M/43/.51</p> <p># 975-M/45/.53</p> <p># 976-M/47/.54</p> <p># 977-F/36/.45</p> <p># 978-F/55/.95</p> <p># 979-M/47/.56</p> <p># 980-F/42/.52</p> <p># 981-M/58/.89</p> <p><u>Pollock Otoliths</u></p> <p>sp# 982-M/49/.79</p> <p style="padding-left: 20px;">#438617</p> <p>sp# 983-F/44/.64</p> <p style="padding-left: 20px;">#438616</p> <p style="padding-left: 20px;">spent</p> </td> </tr> </table> | <table style="width: 100%; border: none;"> <tr><td style="width: 50%; border: none;">M</td><td style="width: 50%; border: none;">F</td></tr> <tr><td style="border: none;">42-1</td><td style="border: none;">(36)-1</td></tr> <tr><td style="border: none;">(43)-1</td><td style="border: none;">39-1</td></tr> <tr><td style="border: none;">(45)-L</td><td style="border: none;">41-1</td></tr> <tr><td style="border: none;">46-1</td><td style="border: none;">(42)-L</td></tr> <tr><td style="border: none;">(47)-L</td><td style="border: none;">(44)-1</td></tr> <tr><td style="border: none;">48-1</td><td style="border: none;">46-1</td></tr> <tr><td style="border: none;">(49)-1</td><td style="border: none;">48-1</td></tr> <tr><td style="border: none;">53-1</td><td style="border: none;">49-1</td></tr> <tr><td style="border: none;">(58)-L</td><td style="border: none;">(55)-1</td></tr> </table> | M | F | 42-1 | (36)-1 | (43)-1 | 39-1 | (45)-L | 41-1 | 46-1 | (42)-L | (47)-L | (44)-1 | 48-1 | 46-1 | (49)-1 | 48-1 | 53-1 | 49-1 | (58)-L | (55)-1 | <p><u>Pollock S/L/W</u></p> <p>sp# 974-M/43/.51</p> <p># 975-M/45/.53</p> <p># 976-M/47/.54</p> <p># 977-F/36/.45</p> <p># 978-F/55/.95</p> <p># 979-M/47/.56</p> <p># 980-F/42/.52</p> <p># 981-M/58/.89</p> <p><u>Pollock Otoliths</u></p> <p>sp# 982-M/49/.79</p> <p style="padding-left: 20px;">#438617</p> <p>sp# 983-F/44/.64</p> <p style="padding-left: 20px;">#438616</p> <p style="padding-left: 20px;">spent</p> |
| <table style="width: 100%; border: none;"> <tr><td style="width: 50%; border: none;">M</td><td style="width: 50%; border: none;">F</td></tr> <tr><td style="border: none;">42-1</td><td style="border: none;">(36)-1</td></tr> <tr><td style="border: none;">(43)-1</td><td style="border: none;">39-1</td></tr> <tr><td style="border: none;">(45)-L</td><td style="border: none;">41-1</td></tr> <tr><td style="border: none;">46-1</td><td style="border: none;">(42)-L</td></tr> <tr><td style="border: none;">(47)-L</td><td style="border: none;">(44)-1</td></tr> <tr><td style="border: none;">48-1</td><td style="border: none;">46-1</td></tr> <tr><td style="border: none;">(49)-1</td><td style="border: none;">48-1</td></tr> <tr><td style="border: none;">53-1</td><td style="border: none;">49-1</td></tr> <tr><td style="border: none;">(58)-L</td><td style="border: none;">(55)-1</td></tr> </table> | M | F | 42-1 | (36)-1 | | (43)-1 | 39-1 | (45)-L | 41-1 | 46-1 | (42)-L | (47)-L | (44)-1 | 48-1 | 46-1 | (49)-1 | 48-1 | 53-1 | 49-1 | (58)-L | (55)-1 | <p><u>Pollock S/L/W</u></p> <p>sp# 974-M/43/.51</p> <p># 975-M/45/.53</p> <p># 976-M/47/.54</p> <p># 977-F/36/.45</p> <p># 978-F/55/.95</p> <p># 979-M/47/.56</p> <p># 980-F/42/.52</p> <p># 981-M/58/.89</p> <p><u>Pollock Otoliths</u></p> <p>sp# 982-M/49/.79</p> <p style="padding-left: 20px;">#438617</p> <p>sp# 983-F/44/.64</p> <p style="padding-left: 20px;">#438616</p> <p style="padding-left: 20px;">spent</p> | | | | | |
| M | F | | | | | | | | | | | | | | | | | | | | | | | | | | |
| 42-1 | (36)-1 | | | | | | | | | | | | | | | | | | | | | | | | | | |
| (43)-1 | 39-1 | | | | | | | | | | | | | | | | | | | | | | | | | | |
| (45)-L | 41-1 | | | | | | | | | | | | | | | | | | | | | | | | | | |
| 46-1 | (42)-L | | | | | | | | | | | | | | | | | | | | | | | | | | |
| (47)-L | (44)-1 | | | | | | | | | | | | | | | | | | | | | | | | | | |
| 48-1 | 46-1 | | | | | | | | | | | | | | | | | | | | | | | | | | |
| (49)-1 | 48-1 | | | | | | | | | | | | | | | | | | | | | | | | | | |
| 53-1 | 49-1 | | | | | | | | | | | | | | | | | | | | | | | | | | |
| (58)-L | (55)-1 | | | | | | | | | | | | | | | | | | | | | | | | | | |
| Pollock | | 31 | 26.40 | 100 | | | | | | | | | | | | | | | | | | | | | | | |
| Pollock | | 42 | 33.60 | 100 | | | | | | | | | | | | | | | | | | | | | | | |
| Pollock | | 40 | 31.20 | 100 | | | | | | | | | | | | | | | | | | | | | | | |
| P. Cod | | 3 | 5.60 | 100 | | | | | | | | | | | | | | | | | | | | | | | |
| Jelly fish | | 2 | .76 | 100 | | | | | | | | | | | | | | | | | | | | | | | |
| Chinook | M | 1 | 2.40 | 100 | <p><u>Chinook FMA ID</u></p> <p>sp# 984 M/53/2.40/Adipose present</p> <p style="padding-left: 20px;">Zone B</p> | | | | | | | | | | | | | | | | | | | | | | |

All lengths that are associated with additional biological data must be circled in the S/L tree.

| | | | | |
|---------------------------------|--------------------------------|----------------------------|--|---|
| Sample #: <u>2</u> | Sub-Sample #: | Sample Size: <u>112.64</u> | <small>Kgs Segments pots</small> | # of Sampled Hooks: |
| Presorted <input type="radio"/> | Combined <input type="radio"/> | | | No Fish in Sample <input type="radio"/> |

| Species | Sex | # | Weight | % ret. | Length, viability, injury, specimen, tally data, measurements, bird observations, sample design, notes: |
|----------------------|-----|-----|--------|--------|---|
| ----- KEYPUNCH ----- | X | 121 | 112.64 | X | |
| Pollock | | 35 | 31.80 | 100 | <div style="border: 1px solid black; padding: 10px; width: fit-content;"> <p>All measured fish, including those with specimen data, must be documented together.</p> </div> |
| Pollock | | 33 | 29.60 | 100 | |
| Pollock | | 41 | 38.00 | 100 | |
| Arrowtooth | | 6 | 4.20 | 100 | |
| P. Cod | | 4 | 8.40 | 100 | |
| Jelly fish | | 2 | .64 | 100 | |

Tally K/P

Ver. 2016

Figure 13-14: Deck Form Example Showing Circling of Length Specimens That Are Also Age Specimens on a BSAI Pollock Catcher Vessel

LENGTH AND SPECIMEN PRIORITY LIST FOR PREDOMINANT SPECIES IN THE BERING SEA/ALEUTIAN ISLANDS

Determine the predominant species in your sample, then consult the block for that species. **If the predominant species in your sample is not in this 3 page chart, sample from the next most predominant species that is in this chart.**

| Predominant Species | Sex/Length Data | Biological Data (All specimen fish must have an associated s/l/w specimen) |
|--|--|---|
| Aleutian Islands (Fed Areas 541, 542, 543) Pollock | Every Sampled Haul ~ 75 pollock | Every Sampled Haul 10 pollock otolith pairs with maturity scan for all female otolith fish |
| Bering Sea Pollock | Every Sampled Haul ~ 20 pollock and ~ 20 squid (unsexed) and ~ 5 Rougheye and ~ 5 Sablefish | Every 5th Sampled Haul 2 pollock otolith pairs with maturity scan for all female otolith fish and ~ 8 pollock sex/length/weight specimens (must not be from an otolith fish) |
| | | Every Sampled Haul 5 Rougheye otolith pairs |
| | | Every 5th Sampled Haul 3 Pacific Cod otolith pairs with maturity scan for all female otolith fish and 2 Shortraker/Rougheye otolith pairs |
| Pacific Cod | Every Sampled Haul ~ 20 Pacific Cod and ~ 10 Shortraker/Rougheye and ~ 5 skates of any species | Every 25th Sampled Haul ALSO COLLECT 1 sex/length and 1 otolith pair from Kamchatka/Arrowtooth |
| | | |
| Halibut | Every Sampled Haul ~10 unsexed halibut lengths and ~ 10-20 s/l from any rockfish species on the RF Species Ranking List | Every Sampled Haul 2 rockfish otolith pairs |

Figure 13-15: Length and Specimen Priority List for Bering Sea/Aleutian Islands Vessels

| Predominant Species | Sex/Length Data | Biological Data (All specimen fish must have an associated s/l/w specimen) | | | | | | | |
|---|----------------------|---|----------------------|---------------------------|------------------|-------------------|--|---|--|
| <p style="text-align: center;">Bering Sea Flatfish *</p> <table border="1" style="width: 100%; border-collapse: collapse;"> <thead> <tr> <th style="text-align: left;">Species Ranking List</th> </tr> </thead> <tbody> <tr> <td>1. Yellowfin Sole</td> </tr> <tr> <td>1. N/S Rocksole</td> </tr> <tr> <td>2. Turbot (Greenland)</td> </tr> <tr> <td>3. Flathead Sole</td> </tr> <tr> <td>3. Alaska Plaice</td> </tr> <tr> <td>4. Kamchatka/ Arrowtooth</td> </tr> </tbody> </table> | Species Ranking List | 1. Yellowfin Sole | 1. N/S Rocksole | 2. Turbot (Greenland) | 3. Flathead Sole | 3. Alaska Plaice | 4. Kamchatka/ Arrowtooth | <p style="text-align: center;">Every Sampled Haul</p> <p style="text-align: center;">~ 16 of the most predominant species in the list, chosen by rank in cases of equal predominance **</p> <p style="text-align: center;">and</p> <p style="text-align: center;">~ 4 from the next most predominant species on the flatfish Species Ranking List</p> <p style="text-align: center;">and</p> <p style="text-align: center;">~ 5 skates of any species</p> <p style="text-align: center;">and</p> <p style="text-align: center;">~5 Rougheyeye</p> | <p style="text-align: center;">Every 5th Sampled Haul</p> <p style="text-align: center;">4 otolith pairs from the ~16 flatfish s/l fish. **If Yellowfin Sole is the predominant species, collect 1 otolith pair</p> <p style="text-align: center;">and</p> <p style="text-align: center;">1 otolith pair from the ~ 4 flatfish s/l fish</p> <p style="text-align: center;">Every Sampled Haul</p> <p style="text-align: center;">3 otolith pairs from the ~ 5 Rougheyeye s/l fish</p> |
| Species Ranking List | | | | | | | | | |
| 1. Yellowfin Sole | | | | | | | | | |
| 1. N/S Rocksole | | | | | | | | | |
| 2. Turbot (Greenland) | | | | | | | | | |
| 3. Flathead Sole | | | | | | | | | |
| 3. Alaska Plaice | | | | | | | | | |
| 4. Kamchatka/ Arrowtooth | | | | | | | | | |
| <p style="text-align: center;">Rockfish *</p> <table border="1" style="width: 100%; border-collapse: collapse;"> <thead> <tr> <th style="text-align: left;">Species Ranking List</th> </tr> </thead> <tbody> <tr> <td>1. Pacific Ocean Perch</td> </tr> <tr> <td>2. Northern Rockfish</td> </tr> <tr> <td>3. Shortraker/ Rougheyeye</td> </tr> <tr> <td>4. Thornyheads</td> </tr> <tr> <td>5. Dusky Rockfish</td> </tr> </tbody> </table> | Species Ranking List | 1. Pacific Ocean Perch | 2. Northern Rockfish | 3. Shortraker/ Rougheyeye | 4. Thornyheads | 5. Dusky Rockfish | <p style="text-align: center;">Every Sampled Haul</p> <p style="text-align: center;">~ 16 of the most predominant species in the list, chosen by rank in cases of equal predominance</p> <p style="text-align: center;">and</p> <p style="text-align: center;">~ 8 from the second most predominant species on the rockfish Species Ranking List</p> <p style="text-align: center;">and</p> <p style="text-align: center;">~ 4 from the third most predominant species on the rockfish Species Ranking List</p> | <p style="text-align: center;">Every Sampled Haul</p> <p style="text-align: center;">3 otolith pairs from the ~ 16 s/l rockfish</p> <p style="text-align: center;">and</p> <p style="text-align: center;">2 otolith pairs from the ~ 8 s/l rockfish</p> <p style="text-align: center;">and</p> <p style="text-align: center;">1 otolith pair from the ~ 4 s/l rockfish</p> | |
| Species Ranking List | | | | | | | | | |
| 1. Pacific Ocean Perch | | | | | | | | | |
| 2. Northern Rockfish | | | | | | | | | |
| 3. Shortraker/ Rougheyeye | | | | | | | | | |
| 4. Thornyheads | | | | | | | | | |
| 5. Dusky Rockfish | | | | | | | | | |
| <p>* For flatfish and rockfish predominant hauls, take length and biological data only from those species that are in the species ranking list. If the predominant species in your sample is not in this list, sample from the next most predominant species that is in this list.</p> | | | | | | | | | |

Figure 13-15: Length and Specimen Priority List for Bering Sea/Aleutian Islands Vessels

LENGTH AND SPECIMEN PRIORITY LIST FOR PREDOMINANT SPECIES IN THE BERING SEA/ALEUTIAN ISLANDS

| Predominant Species | Sex/Length Data | Biological Data (All specimen fish must have an associated s/l/w specimen) |
|----------------------|---|---|
| Skates | <p>Every Sampled Haul ~ 20 from skates of any species</p> | <p>Every Sampled Haul sex/length/weight specimens from the most predominant species in your sex/length collection</p> |
| Sablefish | <p>Every Sampled Haul ~ 20 Sablefish and ~ 10 Shortraker/Rougheye and ~ 5 Giant Grenadier</p> | <p>Every Sampled Haul 3 Sablefish otolith pairs and 2 Shortraker/Rougheye otolith pairs</p> |
| Atka Mackerel | <p>Every Sampled Haul ~ 20 Atka Mackerel and ~ 20 Dark/Dusky rockfish</p> | <p>If in the directed Atka fishery</p> |
| | | <p>Every 2nd Sampled Haul 2 Atka Mackerel otolith pairs</p> |
| | | <p>If NOT in the directed Atka fishery</p> |
| | | <p>Every Sampled Haul 2 Atka Mackerel otolith pairs</p> |

Figure 13-15: Length and Specimen Priority List for Bering Sea/Aleutian Islands Vessels

LENGTH AND SPECIMEN PRIORITY LIST FOR PREDOMINANT SPECIES IN THE GULF OF ALASKA

 Determine the predominant species in your sample, then consult the block for that species. If the predominant species in your sample is not in this 3 page chart, sample from the next most predominant species that is in this chart.

| Predominant Species | Sex/Length Data | Biological Data (All specimen fish must have an associated s/l/w specimen) |
|-------------------------------|--|--|
| Gulf of Alaska Pollock | Every Sampled Haul ~ 50 Pollock and ~ 10 Pacific Cod | Every Sampled Haul 8 Pollock otolith pairs with maturity scan for all female otolith fish and 1 Pacific Cod otolith pair with maturity scan for all female otolith fish |
| Pacific Cod | Every Sampled Haul ~ 20 Pacific Cod and ~ 10 Shortraker/Rougheye and ~ 5 skates of any species | Every 5th Sampled Haul |
| | | 3 Pacific Cod otolith pairs with maturity scan for all female otolith fish and 2 Shortraker/Rougheye otolith pairs |
| | | Every Cruise Up to 5 Big Skate and 5 Longnose Skate vertebrae and maturity |
| Sablefish | Every Sampled Haul ~ 20 Sablefish and ~ 10 Shortraker/Rougheye and ~ 5 Giant Grenadier | Every Sampled Haul 3 Sablefish otolith pairs and 2 Shortraker/Rougheye otolith pairs |
| Atka Mackerel | Every Sampled Haul ~ 20 Atka Mackerel and ~ 20 Dark/Dusky Rockfish | Every Sampled Haul 4 Atka Mackerel otolith pairs |
| Halibut | Every Sampled Haul ~10 unsexed Halibut lengths and ~ 10-20 s/l from any rockfish species on the RF Species Ranking List | Every Sampled Haul 2 rockfish otolith pairs |

Figure 13-16: Length and Specimen Priority List for Gulf of Alaska Vessels

| Predominant Species | Sex/Length Data | Biological Data (All specimen fish must have an associated s/l/w specimen) | | | | | | |
|---|----------------------|---|---|---|------------------------|---|--------------|--|
| <p style="text-align: center;">Gulf of Alaska Flatfish *</p> <table border="1" style="width: 100%;"> <tr> <th style="text-align: left;">Species Ranking List</th> </tr> <tr> <td> <ol style="list-style-type: none"> 1. N/S Rocksole 2. Dover Sole 3. Flathead Sole 4. Rex Sole 5. Kamchatka/ Arrowtooth </td> </tr> </table> | Species Ranking List | <ol style="list-style-type: none"> 1. N/S Rocksole 2. Dover Sole 3. Flathead Sole 4. Rex Sole 5. Kamchatka/ Arrowtooth | <p style="text-align: center;">Every Sampled Haul</p> <p style="text-align: center;">~ 20 of the most predominant species in the list, chosen by rank in cases of equal predominance **</p> <p style="text-align: center;">and</p> <p style="text-align: center;">~ 5 skates of any species</p> <p style="text-align: center;">and</p> <p style="text-align: center;">~ 10 Pacific Cod</p> | <table border="1" style="width: 100%;"> <tr> <th style="text-align: center;">Every 5th Sampled Haul</th> </tr> <tr> <td> <p style="text-align: center;">5 flatfish otolith pairs from the ~20 flatfish s/l fish</p> <p style="text-align: center;">**If Kamchatka/Arrowtooth is predominant in an otolith haul 1 s/l and 1 otolith pair from Kamchatka/ Arrowtooth and 16 s/l and 4 otolith pairs from the next most predominant species on the Flatfish Species Ranking List</p> <p style="text-align: center;">and</p> <p style="text-align: center;">2 Pacific Cod otolith pairs with maturity scan for all female otolith fish</p> </td> </tr> <tr> <th style="text-align: center;">Every Cruise</th> </tr> <tr> <td> <p style="text-align: center;">Up to 5 Big Skate and 5 Longnose Skate vertebrae and maturity</p> </td> </tr> </table> | Every 5th Sampled Haul | <p style="text-align: center;">5 flatfish otolith pairs from the ~20 flatfish s/l fish</p> <p style="text-align: center;">**If Kamchatka/Arrowtooth is predominant in an otolith haul 1 s/l and 1 otolith pair from Kamchatka/ Arrowtooth and 16 s/l and 4 otolith pairs from the next most predominant species on the Flatfish Species Ranking List</p> <p style="text-align: center;">and</p> <p style="text-align: center;">2 Pacific Cod otolith pairs with maturity scan for all female otolith fish</p> | Every Cruise | <p style="text-align: center;">Up to 5 Big Skate and 5 Longnose Skate vertebrae and maturity</p> |
| Species Ranking List | | | | | | | | |
| <ol style="list-style-type: none"> 1. N/S Rocksole 2. Dover Sole 3. Flathead Sole 4. Rex Sole 5. Kamchatka/ Arrowtooth | | | | | | | | |
| Every 5th Sampled Haul | | | | | | | | |
| <p style="text-align: center;">5 flatfish otolith pairs from the ~20 flatfish s/l fish</p> <p style="text-align: center;">**If Kamchatka/Arrowtooth is predominant in an otolith haul 1 s/l and 1 otolith pair from Kamchatka/ Arrowtooth and 16 s/l and 4 otolith pairs from the next most predominant species on the Flatfish Species Ranking List</p> <p style="text-align: center;">and</p> <p style="text-align: center;">2 Pacific Cod otolith pairs with maturity scan for all female otolith fish</p> | | | | | | | | |
| Every Cruise | | | | | | | | |
| <p style="text-align: center;">Up to 5 Big Skate and 5 Longnose Skate vertebrae and maturity</p> | | | | | | | | |
| <p style="text-align: center;">Pacific Ocean Perch</p> <table border="1" style="width: 100%;"> <tr> <th style="text-align: left;">Species Ranking List</th> </tr> <tr> <td> <ol style="list-style-type: none"> 1. Northern Rockfish 2. Dusky Rockfish 3. Shortraker/ Rougheye </td> </tr> </table> | Species Ranking List | <ol style="list-style-type: none"> 1. Northern Rockfish 2. Dusky Rockfish 3. Shortraker/ Rougheye | <p style="text-align: center;">Every Sampled Haul</p> <p style="text-align: center;">~ 10 POP</p> <p style="text-align: center;">and</p> <p style="text-align: center;">~ 10 from the next most predominant species on the Rockfish Species Ranking List</p> <p style="text-align: center;">and</p> <p style="text-align: center;">~ 10 from the third most predominant species on the rockfish Species Ranking List</p> | <p style="text-align: center;">Every Sampled Haul</p> <p style="text-align: center;">1 otolith pairs from the ~ 10 s/l POP</p> <p style="text-align: center;">and</p> <p style="text-align: center;">2 otolith pairs from the ~ 10 second most predominant rockfish</p> <p style="text-align: center;">and</p> <p style="text-align: center;">2 otolith pairs from the ~ 10 third most predominant rockfish</p> | | | | |
| Species Ranking List | | | | | | | | |
| <ol style="list-style-type: none"> 1. Northern Rockfish 2. Dusky Rockfish 3. Shortraker/ Rougheye | | | | | | | | |
| <p style="text-align: center;">Rockfish *</p> <table border="1" style="width: 100%;"> <tr> <th style="text-align: left;">Species Ranking List</th> </tr> <tr> <td> <ol style="list-style-type: none"> 1. Northern Rockfish 2. Dusky Rockfish 3. Shortraker/ Rougheye 4. Pacific Ocean Perch </td> </tr> </table> | Species Ranking List | <ol style="list-style-type: none"> 1. Northern Rockfish 2. Dusky Rockfish 3. Shortraker/ Rougheye 4. Pacific Ocean Perch | <p style="text-align: center;">Every Sampled Haul</p> <p style="text-align: center;">~ 20 of the most predominant species in the list, chosen by rank in cases of equal predominance</p> <p style="text-align: center;">and</p> <p style="text-align: center;">~ 8 from the next most predominant species on the Rockfish Species Ranking List</p> | <p style="text-align: center;">Every Sampled Haul</p> <p style="text-align: center;">3 rockfish otolith pairs, taken from these ~ 20 rockfish s/l fish</p> <p style="text-align: center;">and</p> <p style="text-align: center;">1 rockfish otolith pair taken from these ~ 8 rockfish s/l fish</p> | | | | |
| Species Ranking List | | | | | | | | |
| <ol style="list-style-type: none"> 1. Northern Rockfish 2. Dusky Rockfish 3. Shortraker/ Rougheye 4. Pacific Ocean Perch | | | | | | | | |
| <p>* For flatfish and rockfish predominant hauls, take biological samples only from those species that are in the species ranking list. If the predominant species in your sample is not in this list, sample from the next most predominant species that is in this list.</p> | | | | | | | | |

Figure 13-16: Length and Specimen Priority List for Gulf of Alaska Vessels

LENGTH AND SPECIMEN PRIORITY LIST FOR PREDOMINANT SPECIES IN THE GULF OF ALASKA

| Predominant Species | Sex/Length Data | Biological Data (All specimen fish must have an associated s/l/w specimen) |
|---------------------|--|---|
| Skates | Every Sampled Haul ~ 20 from skates of any species | Every Sampled Haul |
| | | sex/length/weight specimens from the most predominant species in your sex/length collection |
| | | Every Cruise |
| | | Up to 5 Big Skate and 5 Longnose Skate vertebrae and maturity |

Length and Specimen Priority List for Plants and Floating Processors

Collect only from unobserved vessels (*sablefish deliveries are an exception: if an observed vessel delivers live sablefish, collect lengths and ages if the vessel observer was unable to do so) For each sampled delivery, consult the appropriate ranking list below: if the predominant species in your sample is **not** in the species lists (by region), **sample from the next most predominant species that is in the list.**
 **Unobserved GOA pollock deliveries to AFA plants only.

Bering Sea or Gulf of Alaska Roundfish...

- Species List
 Sablefish *
 Rockfish (all species)
 Pollock **
 Pacific Cod (non-trawl)

Bering Sea Flatfish...

- Species List
 Yellowfin Sole
 N/S Rocksole
 Turbot (Greenland)
 Flathead Sole
 Alaska Plaice

Gulf of Alaska Flatfish...

- Species List
 N/S Rocksole
 Flathead Sole
 Rex Sole
 Dover Sole
 Arrowtooth Flounder

| | Sex/Lengths: | Otoliths (taken from s/l fish): | Other Biological Data: |
|---|--|--|---|
| How Often Do You Collect Data? | At least 4 deliveries per day, no more than 150 - 200 s/l per day | At least 4 deliveries per day, maximum of 25 pair per day | Maturity scans if pollock or cod are measured |
| How Many? If only one of the species in the list is predominant then: | collect ~ 20 from the species in the list that is most predominant | collect 5 otolith pairs, taken from these ~ 20 s/l fish | If measuring pollock or P. Cod collect maturity scan data from all female otolith specimens |
| If more than one of the species in the list is predominant then: | collect ~ 20 from each species in the list that are predominant, up to 3 species | collect 2 pairs from each s/l species, up to 3 species | If measuring pollock or P. Cod collect maturity scan data from all female otolith specimens |
| What if it's a Gulf flatfish delivery and the predominant species is Arrowtooth? | | | |
| If Arrowtooth is the only predominant then: | collect ~ 20 from Arrowtooth | DO NOT collect otoliths from Arrowtooth | none |
| Any from another species? | ~ 20 from another species on the list | collect 5 otolith pairs from the s/l fish of the other species | none |
| If Arrowtooth is one of several predominant species then: | collect ~ 20 from Arrowtooth | DO NOT collect otoliths from Arrowtooth | none |
| Any from another species? | ~20 from other predominant species on the list, up to 2 species | collect 2 pair from each of the other s/l species | none |

Figure 13-17: Length and Specimen Priority Lists for Plants and Floating Processors

MARINE MAMMAL INTERACTIONS AND SIGHTINGS

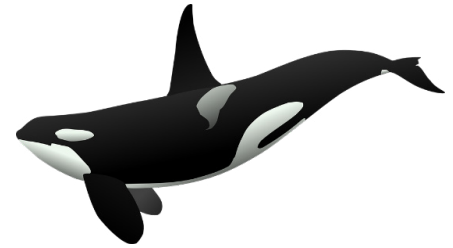

Table of Contents

| | |
|--|-------|
| List of Priorities | 14-1 |
| Introduction | 14-1 |
| Marine Mammal Protection Act | 14-1 |
| Marine Mammal Monitoring | 14-2 |
| Selecting Hauls for Marine Mammal Monitoring | 14-2 |
| Marine Mammal Interactions | 14-2 |
| Entering Interaction Data on the Marine Mammal Data Form | 14-4 |
| Comment Entries on the Marine Mammal Data Form | 14-6 |
| Marine Mammal Specimens | 14-7 |
| Safe Environment to Collect Marine Mammal Specimens | 14-7 |
| Photos | 14-7 |
| Marine Mammal Specimen Collection Safety Protocols | 14-8 |
| Collection of Deep Tissue Samples | 14-8 |
| Collection of Pinniped Snouts (Except Walrus) | 14-9 |
| Sex Determination of Dead Marine Mammals | 14-10 |
| Measurements of Dead Marine Mammals | 14-10 |
| Entering Specimen Data on the Marine Mammal Data Form | 14-11 |
| Tagged and Branded Marine Mammals | 14-12 |
| Intentional Feedings | 14-12 |
| Marine Mammal Sightings | 14-12 |
| Marine Mammal Sighting Form Instructions | 14-12 |
| Marine Mammal Sightings and Interactions at a Processing Plant | 14-14 |

LIST OF PRIORITIES

- Record marine mammal interaction data.
- Record marine mammal specimen data.
- Record marine mammal sightings.

INTRODUCTION

Alaskan waters support one of the largest fisheries in the world and are home to a vast number of marine mammals. Interactions between fishing operations and marine mammals are unavoidable. Observers provide the data needed to generate estimates of marine mammal injury and mortality and other interactions due to fishing operations. These estimates are reported in the Alaska Marine Mammal Stock Assessment Reports and used to classify and manage fisheries. Vessel owners and operators are required to submit reports of marine mammal injury and mortality that occur as a result of fishing operations. The Observer Program's independent data help determine the reliability of these reports.

Observer data are also used to identify changes in fishing methods or technology that may increase or decrease incidental injury or mortality of marine mammals.

Marine mammal sighting data collected for the Marine Mammal Laboratory (MML) by observers provide important information on the distribution and behavior of marine mammals in Alaskan waters. There are several species in the Gulf of Alaska and Bering Sea which are threatened or endangered, and information on these animals is of great interest.

MARINE MAMMAL PROTECTION ACT

The Marine Mammal Protection Act of 1972 (MMPA) was most recently reauthorized in 1994. In passing the MMPA in 1972, Congress found that:

- Certain species and population stocks of marine mammals are, or may be, in danger of extinction or depletion as a result of human activities.
- Such marine mammal species and population stocks should not be permitted to diminish beyond the point

at which they cease to be a significant functioning element in the ecosystem of which they are a part. Consistent with this major objective, they should not be permitted to diminish below their optimum sustainable population level.

- Measures should be taken immediately to replenish any species or population stock which has diminished below its optimum sustainable level.
- Marine mammals have proven themselves to be resources of great international significance, aesthetic and recreational as well as economic.

The MMPA established a moratorium, with certain exceptions, on the taking of marine mammals in U.S. waters and by U.S. citizens on the high seas, and on the importing of marine mammals and marine mammal products into the United States. As a NMFS certified observer you are authorized, under title 50 of the Code of Federal Regulations (CFR), to collect and possess marine mammal specimens (see page 20-23). The only specimen samples you should ever have in your possession are snouts and/or tissue samples from pinnipeds and cetaceans. *Do not collect other bones, or parts as specimens.* They are not needed and will be discarded. Walrus and sea otters are under the jurisdiction of the U. S. Fish and Wildlife Service. You are not allowed to possess any specimen material from them. Possession of any part of a walrus or sea otter is a federal offense.



Sea otters are listed as “threatened” and both NMFS (Sustainable Fisheries) and USFWS should be notified of any incidental takes.

MARINE MAMMAL MONITORING

The role of observers under the MMPA is to conduct statistically reliable monitoring of fishing operations and to record information on all interactions between fishing operations and marine mammals. If possible, observers should take photographs of any marine mammal involved in an interaction. Observers are asked to determine sex and measure the length of any marine mammal found dead in the catch. Observers are required to collect tissue samples, which are used for species, sex, and stock determinations, from any pinniped or cetacean captured and killed during fishing operations. Observers are also asked to collect the upper snout including the canine teeth, and vibrissae (whiskers) from any pinnipeds

captured and killed in fishing operations. Interaction and specimen data are transferred directly from the raw data recorded on the Deck Form to the Marine Mammal Data Form in ATLAS.

Selecting Hauls for Marine Mammal Monitoring

To provide statistically reliable information you must randomly select which hauls are to be monitored for incidental take of marine mammals. If you are not able to monitor all of the hauls, monitor the same hauls that are randomly selected for species composition sampling. *You may monitor additional sets but if there are any marine mammal interactions, you must indicate in the Comments section of the Marine Mammal Data Form that they are not from randomly selected hauls or sets.* In the trawl fishery, you will not always be able to watch the entire dumping of a haul. It is acceptable to spot check the dumping and still mark the haul as being monitored 100% for marine mammals. If you use the spot checking option, you must be certain that you would have seen the discard of a marine mammal had it occurred.

MARINE MAMMAL INTERACTIONS

All marine mammal interaction data are recorded as raw data on the Deck Form. Also, document details of your observations in your logbook daily notes (see Figure 14-15 on page 14-19, and Figure 14-18 on page 14-22). Marine Mammal Interactions include the following:



- **Deterrence Used:** marine mammals are subjected to deliberate actions intended to frighten, harm, or discourage them in order to limit or avoid interactions with fishing operations. The animal may be in direct contact with gear or in very close proximity. Deterrence methods include but are not limited to yelling at the animal, banging pots or other objects, and acoustical devices. MMPA provisions allow fishermen to deter a marine mammal from damaging fishing gear and catch so long as the deterrent does not result in the death or serious injury of a marine mammal. *Document deterrence interactions even if the deterrence had no effect.*

- **Feeding On Catch or Discards:** marine mammal feeding on fish from the fishing gear prior



to landing, or feeding on discards. Marine mammals such as killer whales, sperm whales, and sea lions are often seen pulling fish from nets or more commonly from longline gear. On a longline vessel, signs of marine mammals feeding on catch include fish heads, lips, or fish that have been bitten or raked by teeth. (See “Method for Tallying Depredated Items” on 8-11 for more information on depredation.) A sudden drop in catch numbers in the presence of marine mammals may also indicate feeding on catch. Use your best judgment to determine if the sudden drop in catch rates may be attributed to them. Knowledge of the feeding habits of these three animals may help in your assessment of whether the depredation was considerable or not.

1. For killer whales you may only see a few lips or heads, but there will be very little catch of some species (for example a sharp decline in sablefish). Whenever killer whales appear to be depredating on the catch, you can assume it is most likely considerable (code 8 for gear performance on the VHF Form).
2. For sperm whales, if they appear to be diving on the line and there is more than one head, lips, or mangled fish coming up on the line, it is likely to be heavy depredation and you should code it as considerable depredation (code 10 for gear performance on the VHF Form).
3. For a sea lion taking fish, the behavior is usually to take a couple of fish and then move on. This often occurs within sight of the vessel. If you see fish being removed by a sea lion, mark these hauls as considerable depredation (code 7 for gear performance on the VHF Form). The number of fish removed will usually not be as great when compared to other mammal depredation.

If you are unsure, record the event as a sighting and document the details so it can be reviewed with your inseason advisor or during debriefing. For information on how to tally depredated items, see “Method for Tallying Depredated Items” on 8-11. Do not record intentional feedings of marine mammals by humans on the Marine Mammal Data Form unless this occurs in conjunction with other interactions. See “Intentional Feedings” on 14-12.

A new interaction must be recorded with the corresponding haul number for each haul that shows evidence of whale depredation or whales feeding on catch (e.g., if longline hauls 122, 123, and 124 all show evidence of depredation, three separate interactions are recorded with one interaction for each haul). Considerable depredation by mammals should be recorded using the appropriate gear performance code on the Vessel Haul Form. See “Gear Performance” on page 7-19. If a deterrent is used or attempted (i.e. bagging off), “deterrence used” must be entered as another interaction type on the Marine Mammal Data Form in ATLAS.

- **Entangled in Gear:** marine mammals are entrapped or entangled in fishing gear but escape or are released alive by vessel personnel.
- **Killed by Gear:** marine mammals are killed by entanglement or entrapment in fishing gear during a particular haul or set. The animal is not decomposed and does not show any evidence of death by something other than the fishing gear. Freshly dead animals can be warm or cold, depending on the length of the tow or set, and the time of death. Rigor mortis is not a good indicator, as the period of time an animal is in rigor can vary greatly depending on its physical condition and the environment. Signs that a marine mammal was killed by gear include:
 - Observer or crew member visually observed its death.
 - Body intact and in good condition.
 - Froth around nose, mouth.
 - Free flowing blood or other body fluids and bright red blood or muscle.
 - No obvious odor.



All interactions involving a freshly dead pinniped and/or cetacean caught in fishing gear, must be reported immediately to your inseason advisor. The message should include specific details about the event. This information should also be documented in your logbook daily notes.

Previously Dead: the mammal was already dead before coming in contact with fishing gear. Vessels often catch bones and/or masses of decomposed flesh; these are

also considered previously dead. If you believe that the same dead animal has been caught in the gear more than once, record it each time and indicate in the comments section of the Marine Mammal Data Form in ATLAS why you believe it to be the same individual. Signs that a marine mammal was previously dead include:

- Eyes sunken or missing
- Skin/fur is discolored, sloughing off, or gone.
- Scavenger damage, especially around the eyes and mouth.
- Bloating, or body may appear misshapen or collapsing.
- Putrid, rotted smell
- Blubber and muscle falling off bones.

Look for signs of trauma which may have been caused by something other than the fishing gear (e.g., gunshot wounds, decapitation, skinning.)

- **Lethal Removal:** marine mammals are killed by vessel personnel to prevent serious damage to or loss of gear, catch, or human life. The death of these animals is caused directly by the actions of vessel personnel and not solely through contact with the fishing gear.
- **Killed by Propeller:** marine mammals are struck by the propeller of the fishing vessel and die.
- **Injured by Vessel:** the marine mammal was injured or struck by the vessel but the animal was still alive when the interaction ended. This may also include animals with fresh propeller wounds (curvilinear parallel incised/chop wounds) but still alive.
- **Marine Mammal Boarded Vessel:** marine mammals board the fishing vessel and then escape. Sea lions and seals will occasionally board vessels to look for food or to escape predators. *If a deterrent is used or attempted to remove a mammal from the vessel, “deterrence used” must be entered as another interaction type on the Marine Mammal Data Form in ATLAS.*

ENTERING INTERACTION DATA ON THE MARINE MAMMAL DATA FORM

Marine mammal interaction data recorded on the Deck Form are transferred directly to the Marine Mammal Data Form in ATLAS. Record as much information and detail as possible on the Deck Form to ensure that all the pertinent data can be entered in ATLAS (see Figure 14-14 on page 14-18 and Figure 14-16 on page 14-20). Sketch observations of rare or unusual marine mammal species involved in interactions. Make sure that all header information is complete on all Deck Forms if the marine mammal interaction is not associated with a haul.

Trip/Haul/Offload: Mammal data can be entered at the trip, haul, or offload level. Select the trip, haul, or offload number associated with the interaction and/or specimen data. An example of a trip level interaction is the vessel using an acoustical device on a daily basis regardless if whales are present or not. If whales are present for a specific haul and the acoustical device is being used, the interaction is at the haul level. An offload interaction example would be a sea lion boarding your vessel while offloading at the dock. You will need to enter date and location of interactions at the trip and offload level.

Species Name: Select the common name of the marine mammal species involved. Be as specific as possible. If you are unsure of the identification use a broader classification, such as unidentified pinniped or unidentified dolphin/porpoise. Do not enter different species in the same record if more than one species of marine mammal are involved in an interaction. Each species must have a separate record.

Number of Animals (observed): Enter your best estimate of the number of individual animals in the area when the interaction occurred. If there are more than one species involved in the interaction, each species must have a separate record on the Marine Mammal Data Form. The number must be an exact number. Do not enter a number range. If you are unsure about how many individuals there are, enter your best estimate and include the number range in the comments field.

Interaction date: Enter the date if the marine mammal interaction was recorded during a Trip.

Number of Animals (in interaction): Enter the number of animals involved in the interaction.

Did you observe mammal?: “Y” if you actually saw the animal, and “N” if you did not.

Interaction Code: Enter the appropriate code from the following list of Marine Mammal Interaction Codes. If an animal is involved in more than one interaction during one trip/haul/offload, list them as separate records on the Marine Mammal Data Form.

Marine Mammal Interaction Codes

1. **Deterrence Used** - Marine mammal was deterred or a deterrence was attempted. Log this interaction using this code even if the deterrence was not successful.
2. **Entangled in Gear (Not Trailing Gear)** - A marine mammal was captured by the fishing gear and the animal was released/escaped alive without fishing gear attached.
3. **Entangled in Gear (Trailing Gear)**- A marine mammal was captured by the fishing gear and the animal was released/escaped alive with some fishing gear attached.
4. **Killed By Gear** - A marine mammal was captured and died due to interactions with the fishing gear.
5. **Killed By Propeller**- A marine mammal hit the propeller and died.
6. **Previously dead** - A marine mammal was captured by the fishing gear and was dead prior to coming into contact with the vessel or fishing gear.
7. **Lethal removal (Trailing Gear)** - Vessel personnel killed a marine mammal entangled in fishing gear, but death was not due entirely to the entanglement. Gear was observed attached to the animal after the animal was removed from the gear.
8. **Lethal removal (Not Trailing Gear)** - Vessel personnel killed a marine mammal entangled in fishing gear, but death was not due entirely to that entanglement. No gear was observed trailing from the animal after the animal was removed from the gear.
9. **Boarded Vessel** - A marine mammal boarded the vessel on its own volition.
10. **Feeding on Catch (Not Yet Landed)** - A marine mammal was observed feeding on catch not yet landed.

12. **Other** - Interaction occurred that is not included in the list of interaction codes.

13. **Unknown** - The vessel or vessel personnel had some interaction with a marine mammal, but the observer did not directly view the interaction and/or ascertain what the interaction was.

14. **Feeding on Discarded Catch** - A marine mammal was observed feeding on discarded catch.

15. **Injured by Vessel** - a marine mammal was injured or struck by the vessel but the animal was still alive when the interaction ended.

Condition Code: Record the condition of the mammal based on the outcome of the interaction. A live animal that has been lethally removed is to be considered a carcass, however, an injured animal released alive is considered alive even if you believe it may eventually die.

1. Carcass, dead animal
3. Live animal
10. Bones and/or skull
11. Other partial remains

Injured?: If the condition code of the mammal was code 3 (live animal), record whether or not the animal appeared injured. Record “Y” if you actually observed the animal to be injured, enter “N” if you observed the animal to be uninjured, or “U” if you are unsure as to the condition of the animal. A written comment indicating if the animal was injured is also required in the marine mammal interaction comments.

Deterrence Code: Fill in this field only for interactions involving marine mammal deterrence, interaction code 1. Refer to the following list for the code that is most appropriate. If the interaction was not one of deterrence, leave this field blank.

Marine Mammal Deterrence Codes:

1. **Seal Bombs** - Any explosive device used to frighten marine mammals away from the catch.
2. **Pole Gaff**- Using the long pole (typically used by crewman to gaff drop-off catch) to scare off marine mammals either by direct contact or by hitting the water.
3. **Skiff**-Any use of a skiff to attempt to frighten off

marine mammals.

4. **Acoustical device** - Any electronic acoustical device designed to frighten or annoy marine mammals.
5. **Yelling** - Crew yelling at marine mammals in order to frighten them away from the catch.
6. **Making noise by any other method** - Any method, other than yelling, of making noise to annoy or frighten marine mammals away from the catch.
7. **Other** - Any other means, not listed above, of deterring marine mammals. Include instances when the vessel changed fishing behavior, such as “bagging off” gear on a longliner. Document the method or occurrence in your logbook.
8. **Unknown** - If a deterrence method was used but its exact nature is unknown.

If the vessel personnel employed more than one method of deterrence, document this in the comments field. Also describe in the comments field how the deterrence was conducted.

Deterrence Successful?: Fill in this field only for interactions involving marine mammal deterrence, interaction code 1. Otherwise leave this field blank. If you observed that the deterrence worked to deter marine mammals away from the catch enter a “Y”. Enter “N” if you observed that the deterrence was unsuccessful. Enter “U” if you are unsure as to the success of the deterrence method.

Food Species: Fill in this field only if you have a marine mammal feeding on catch, interaction code 10. Otherwise leave this field blank. Enter the species code of the species upon which the marine mammals are feeding using the Species Codes for Fishes and Invertebrates starting on page A-3. If the marine mammals are feeding upon more than one species, record the predominant species in the Food Species field and list the other species in the Comments field.

COMMENT ENTRIES ON THE MARINE MAMMAL INTERACTION FORM

Detailed comments regarding marine mammal interactions are vital to data users’ understanding of these interactions and help ensure that the data are used appropriately.

Comment entries are required for all marine mammal interactions. Each comment entry should include the following:

- **Marine Mammal Monitoring:** If the interaction took place at the haul level indicate whether or not the haul was selected to be sampled for species composition.
- **Species Identification:** Write a description of the animal and what features led you to identify it as this species. Document any distinguishing characteristics that helped you differentiate it from others species (i.e., saddle patches for killer whales, spots and scars for other marine mammals, etc).
- **Was the Marine Mammal Observed:** If you did not observe the animal, briefly explain why not and indicate where and how you received the information.
- **Description of Interaction:** Write a description of the interaction between the vessel and the marine mammal. Be as descriptive as possible.
- **Determination of sex:** If you were able to determine the sex of the animal, describe how this determination was made.
- **Condition of the Animal:** Write a description of the general welfare of the animal (e.g., did not look healthy, injured, rotting, etc).
- **Injuries:** If the interaction involved a live animal describe whether or not the animal appeared injured. Document any uncertainty you have as to the condition of the mammal.
- **Deterrence Interactions:** If the interaction involved the use of a deterrent, describe any resulting injuries or mortalities.
- **Uncertainties:** Record any uncertainties you have concerning the data, if any.

Entanglement interactions and interactions involving feeding on catch not yet landed or discarded catch require additional information in the comment entries to help ensure data users fully understand the events that took place.

Feeding on catch not yet landed or discarded catch interactions

The following comments are required in ATLAS for feeding on catch not yet landed or discarded catch interactions.

- Proximity of the marine mammals to the vessel.
- Target species
- Type of bait being used (if applicable)
- Evidence of feeding
- Species of the depredated fish
- Total number of fish with evidence of depredation
- Number of hooks retrieved with only fish heads/lips remaining (if applicable)
- The size of gashes, in centimeters, found on the fish (if applicable)

Entanglement interactions

The following comment is required in ATLAS for entanglement interactions.

- Did any part of the gear remain attached to the animal after it was freed? If yes, describe the amount and which components of gear remained on the animal. Document the location of the gear on the animal and how the gear was attached. Was the gear loosely or tightly wrapped around the animal or was it draped over the animal? If the animal was hooked, where on the body was the hook? How much line was trailing? Was line seen going into the animal's mouth (indication that the animal ingested a hook)? Provide as much detail as possible when describing the attached gear.

Due to ATLAS software constraints, the amount of information that can be sent through the marine mammal interaction comments is limited. It is extremely important that the following additional information be documented in your Daily Notes for an entanglement interaction.

- What components of the fishing gear were attached to the animal (i.e. was the animal entangled in the groundline, anchorline, buoy line, or some other portion of the gear)?

- How was the animal freed from the gear? Was the animal able to free itself or did the crew have to cut gear away from the animal?
- Which parts of the animal were you able to examine for attached gear?
- Which parts of the animal could you not see?
- Was any component of the fishing gear lost? If yes, how was it lost and what type was it?
- Describe any injuries observed on the animal, including the size, shape, texture, depth of the wound. Was fresh blood seen?
- Describe the animal's behavior during and after the interaction (i.e., floating at surface, vocalizing, struggling, diving, tail slapping, breaching).

See Figures 14-17 and 14-18 on pages 14-21 and 14-22 for examples of the expected documentation of entanglement interactions on the Deck Form and in the Daily Notes.

Entangled marine mammals can be dangerous and unpredictable. Be cautious and maintain a safe distance from the animal at all times.



Any comments not directly related to the interaction data, such as cooperation or hindrance by the crew, should be documented in your logbook. Reference the trip/offload or haul number to which the comments pertain.

MARINE MAMMAL SPECIMENS

Specimen data collected from marine mammals are recorded on the Deck Form as raw data and transferred directly to the Marine Mammal Data Form in ATLAS.

Safe Environment to Collect Marine Mammal Specimens

Always check with vessel or plant personnel to determine a safe location to collect specimens from a dead marine mammal. A safe location should keep you away from fishing gear and other hazards, and it should minimize potential cross contamination with food processing areas.

Photos

Use your NMFS issued camera to take photos of all marine mammal interactions (for both pinnipeds and cetaceans) and related data points such as carcasses, entanglements (during and after), injuries, evidence of fish damaged by depredation from sperm whales, killer whales and/or sea lions, and mammals feeding on discarded catch. Photograph the animal from as many angles as possible; video of live animals can be very helpful too. *Remember to take a photo of every marine mammal that you collect specimen data from.* This photo should include a completed bag and tag label to ensure that it can be traced to the appropriate marine mammal interaction and specimen data.



Any photos or videos taken by an observer while assigned to a vessel or plant are the property of the National Marine Fisheries Service as defined by the Magnuson-Stevens Fishery Conservation and Management Act. See "Photos and Videos" on page 2-9 for more information regarding the confidentiality of photos and videos.

Marine mammal photos should include the following characteristics:

- Full body, from several angles.
- Head, straight-on and in profile.
- Ventral surface/sex determination.
- Pinniped flippers.
- Cetacean dorsal fin and flukes (underside).
- Saddle patches, distinctive markings, scars, etc.



Do not collect any specimens (tissue or snout) from walrus. They are managed by the US Fish and Wildlife Service and are therefore not covered under our MMPA collection permit. Do take photos of all walrus interactions.

Marine Mammal Specimen Collection Safety Protocols

Marine mammals may carry many diseases that are transferable to humans. However, the risk for skin and flu-like infections is very low and is further minimized

by following these simple procedures when handling a marine mammal carcass:

- When handling a dead marine mammal, always wear gloves and eye protection.
- To minimize contamination of the sample, ensure the knife you are using is clean before collecting the sample.
- Once the sample is collected, clean the knife by scrubbing with soap in warm water, rinse with fresh water if possible, and dry thoroughly.

Collection of Deep Tissue Samples

The Marine Mammal Laboratory has asked that observers collect a deep tissue sample from all pinniped and cetaceans captured and killed by gear. Deep tissue samples are used to confirm the species and sex of the animal (i.e., genetic analysis of muscle tissue) and can also be tested for contaminants, stock identification, and other important biological information. You should also collect a deep tissue sample from previously dead cetaceans that are still in reasonably good condition and largely intact. *Do not collect samples from previously dead pinniped or cetacean carcasses with skin falling off the bone, unrecognizable body, gelatinous tissue, or missing skin.*

To collect a deep tissue sample:

1. After measuring the carcass, lightly scrape the sample area clean with a knife to remove fish slime and reduce contamination of the sample.
2. Using a sharp knife, cut a 2-4 inch square on the back. For pinnipeds, a good area to cut is between the pectoral flippers (see Figure 14-1). For cetaceans, cut posterior to the dorsal fin (see Figure 14-2).

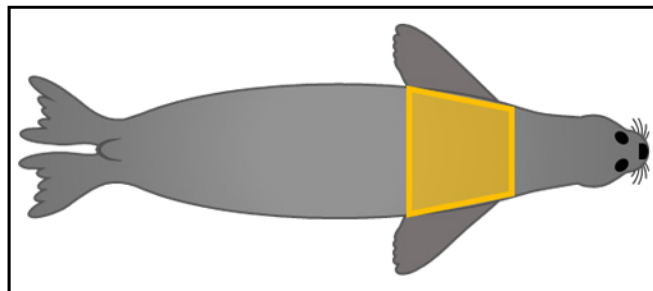

Figure 14-1: Pinniped Deep Tissue Collection Zone

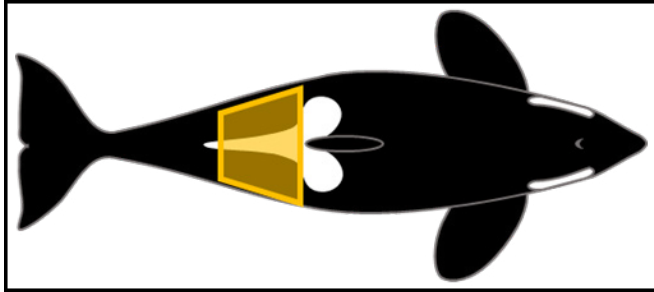

Figure 14-2: Cetacean Deep Tissue Collection Zone

- The depth of the tissue sample should be from the outer skin/fur layer, through the blubber, and at least 1 inch of red muscle tissue (see Figure 14-3). Blubber thickness varies among species and you may need to cut deeper/shallower to get to the red muscle tissue. For some small pinnipeds, it may not be possible to get 1 inch of red muscle tissue in your sample; get as much as you can.

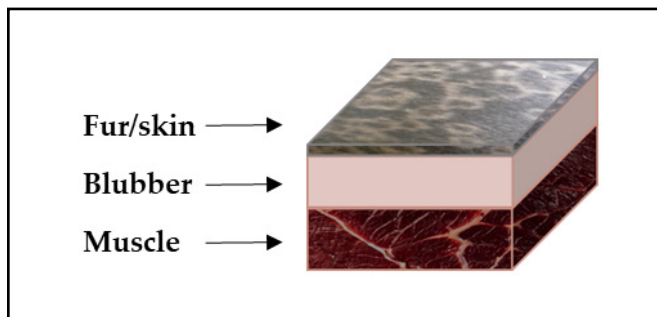

Figure 14-3: Deep Tissue Sample

- To store the sample, wrap it in aluminum foil or seal it in a Ziploc bag (aluminum foil is preferred). Place foil package (or sealed Ziploc bag) inside another Ziploc bag with a completed Bag and Tag Specimen Collection Label. Write the species and length of the animal in the comments sections of the label. *This sample should be frozen and kept frozen to the best of your ability during transit.*

Collection of Pinniped Snouts

Collect the upper snout from all pinnipeds killed by the fishing gear. This may require a hacksaw which you may be able to obtain from the vessel. The canine teeth in the upper snout are used to determine the animal's age and, along with the vibrissae, provide information about the animal's diet. Combined with other biological data you

collect, this information can help determine the health of these populations.



Only collect snout and deep tissue specimens from pinnipeds that were killed by gear. Do not collect snout and tissue specimens from previously dead pinnipeds.

To collect a pinniped snout:

- Cut across the snout, immediately in front of the eyes, in a line that connects the corners of the mouth. The placement of your cut is important to avoid cutting through the roots of the canine teeth, which must be intact to determine the age of the animal (see Figure 14-4 and Figure 14-5).

A complete snout that is cut far back enough will include all of the vibrissae and 2-3 post-canine (behind the canine) teeth on each side (see Figure 14-6). If your cut is not ideal, that's okay – it is still a valuable sample.

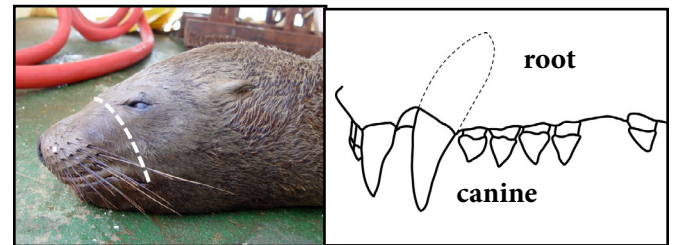

Figure 14-4: Otariid Snout Collection



Figure 14-5: Phocid Snout Collection

- Do not trim or remove the vibrissae, fur, or skin (see Figure 14-6).

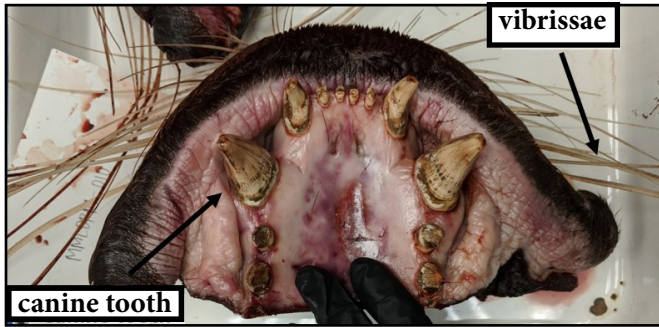

Figure 14-6: Pinniped Snout

3. To store the snout, place it in three plastic bags provided by NMFS and freeze it. Place a Bag and Tag Specimen Collection Label (see page 2-15) inside the outer bag and another label on the outside. Write the species and length of pinniped in the comments sections of the label.

 **All pinniped and cetacean biological specimens should be frozen and kept frozen to the best of your ability during transit.**

Sex Determination of Dead Marine Mammals

To accurately determine the sex of marine mammals, you will need to examine the ventral body surface. If necessary, ask for assistance to move the carcass and access the appropriate part of the body.

Pinniped Sex Determination: begin by locating the umbilicus (navel) and the perineal area below the tail (see Figure 14-7). Note that some of these parts may be partially or completely covered by fur.

- Females have two openings in the perineal area (the vulva and the anus).
- Males have one opening (the anus) in the perineal area and a prepuce (penile opening) mid-way between the umbilicus and the anus. The penis may also be extended/visible (this is more common in Steller sea lions).

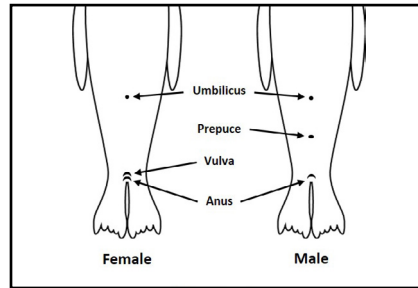



Figure 14-7: Diagram of Pinnipeds Sex Determination

 **In pinnipeds, it may be more reliable to check for the presence/absence of the prepuce instead of the vulva; animals may defecate, making it difficult to see the vulva (if present) and anus.**

Cetacean Sex Determination: begin by locating the umbilicus (navel), the genital slit, and the anus (see Figure 14-8).

- Females have a single ventral slit which contains both the genital slit and the anus. Females also have a mammary slit on each side of the genital slit.
- Males have a genital slit that is located between the umbilicus and the anus.

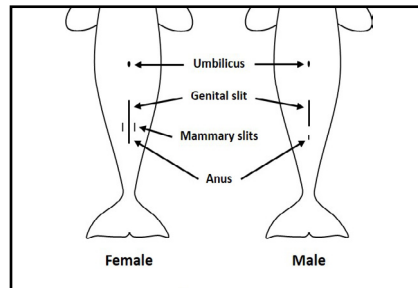



Figure 14-8: Diagram of Cetacean Sex Determination

 **In cetaceans, it may be more reliable to check for the presence/absence of mammary slits around the genital slit; although females are generally described as having a single ventral slit, the genital slit and anus may appear separate.**

Measurements of Dead Marine Mammals

All dead marine mammals captured during fishing operations must be measured. There are two acceptable methods for measuring marine mammals.

Standard length: This is the preferred method of measurement. Measure the animal in a straight line from the tip of the snout or rostrum to the tip of the tail flesh

or tail notch on the body, belly up, ideally with the head and vertebral column on a straight line (see Figure 14-9). Record your measurement to the nearest centimeter.

Curvilinear length: Shortest surface distance from the tip of the snout or rostrum to the tip of the tail or tail notch along the back, belly, or side. This method is used if rigor has set in or the animal is too large or deteriorated to maneuver. Take the measurements with the flexible measuring tape provided by NMFS (see Figure 14-9). Record your measurement to the nearest centimeter.



Do not record estimated lengths. If you are not able to measure the dead marine mammal, include length estimates in the comments field and leave the measurement value blank.

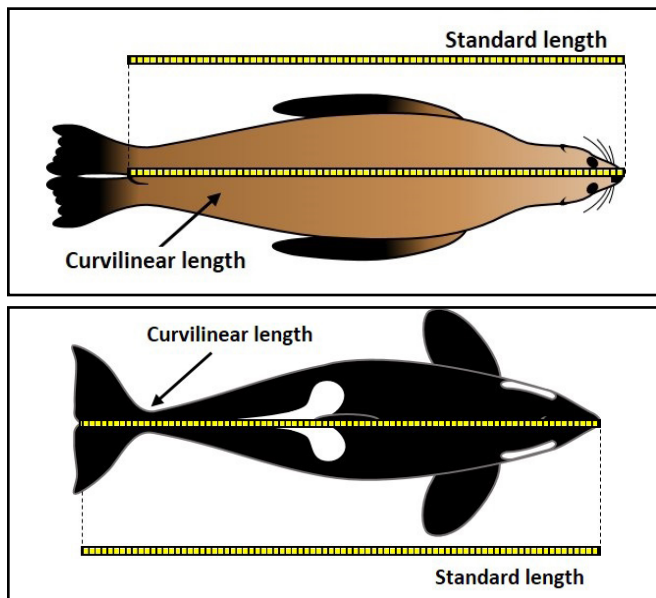

Figure 14-9: Pinniped (top) and Cetacean (bottom) Measurements

ENTERING SPECIMEN DATA ON THE MARINE MAMMAL DATA FORM

Each specimen taken from a marine mammal must be entered separately, with its own unique specimen number. If specimens are collected from more than one animal involved in the same interaction, the data are entered separately for each animal. See Figure 14-14 on page 14-18 for an example of raw data documentation. These data is directly entered in the Marine Mammal Data Form in ATLAS.

Specimen Number: Enter a unique number for each specimen collected. *Do not duplicate specimen numbers.* If there are multiple specimens collected from the same mammal, each specimen must have a unique specimen number. Mammal specimen numbers are independent from fish and bird specimen numbers.

Animal Number: Animal number is used to designate the animal from which a specimen was collected. When there are multiple animals of the same species involved in a single interaction, and multiple specimens taken, you use animal number to indicate which animal supplied the specimen. For each interaction, number animals beginning with 1.

Specimen Type: Enter the appropriate code for the specimen type taken from the animal. All specimen animals should have an associated photo specimen type (code 1). Codes are as follows:

1. Photo
2. Snout
3. Tissue
4. Standard Length
5. Curvilinear Length

Sex: Record the sex of the individual for which a specimen was collected. When entering multiple specimens from the same animal, make sure that sex is the same for all entries.

Value: Photo, standard length, and curvilinear length specimen codes must have a corresponding value.

| If Specimen Code is: | The Value is: |
|------------------------|---|
| 1 - Photo | number of photos taken |
| 4 - Standard Length | standard length of mammal in centimeters |
| 5 - Curvilinear Length | curvilinear length of mammal in centimeters |

Comments: If a snout or tissue specimen was collected, describe your collection method, and how the specimen was stored. For photos, describe the types of images (photos and/or videos), where they were taken, and what was photographed. Record any other pertinent information regarding any of the specimens collected from the marine mammal in this field.

TAGGED AND BRANDED MARINE MAMMALS

The Marine Mammal Laboratory and several other state and federal programs have on-going projects tracking marine mammals. To do this, they place a tag or brand (permanent marking) on the marine mammal (see Figure 14-10). Radio and/or satellite tags have been affixed to Steller sea lions, northern fur seals and elephant seals as well as several cetacean species. Flipper tags are also placed on several species of pinnipeds. Brands are commonly found on the side or back of pinnipeds.

If you observe one of these animals, take copious images! Record the brand (usually a letter or symbol and numbers), number and color of the tag, and the location of the marking/tag in the daily notes section of your logbook. Document their behavior. Complete a Marine Mammal Sighting Form (see example on pages 14-16 and 14-17) to record this observation.



For branded pinnipeds, the letter or symbol identifies where they were born and the number is unique to the individual. Some letters/symbols you might see in Alaska include A (Ugamak Is.), T (Marmot Is.), X (Sugarloaf Is.), and ~ (tilde; Agattu Is.).



Figure 14-10: Branded Steller Sea Lion A460 (left) and Tagged Northern Fur Seal 0825X (right)

If you encounter a tagged or branded marine mammal killed by the gear, record the brand, number and color of the tag, and location of the marking/tag. Take extra photos of the brand or tag, including close-up pictures and zoomed out images showing its location on the body. Check both sides of the body for tags. Retrieve any research instrumentation/attachments affixed to the animal, including flipper tags, to return to the MML. Take the length and determine the sex of the animal. Collect the snout and a deep tissue sample if it is a pinniped. Collect a deep tissue sample from cetaceans. These animals are being tracked for population assessments and to estimate survival and reproductive rates so any

information you can provide will greatly help researchers at the MML.

INTENTIONAL FEEDINGS

Under the Marine Mammal Protection act, it is illegal to intentionally feed any marine mammal in the wild. Intentional feeding is considered a form of harassment. If you observe anyone intentionally feeding a marine mammal, you should document the incident fully in your log book. Please include the names of all involved in the incident, a description of the marine mammal, and a detailed summary of where and how it happened.

MARINE MAMMAL SIGHTINGS

The Marine Mammal Sighting Form helps MML determine the distribution and behaviors of marine mammals. Data from these forms are integrated into the MML Platforms of Opportunity database, which contains information on marine mammals throughout the North Pacific Ocean. The Marine Mammal Sighting Form is not only used by the Observer Program but is also given to the Coast Guard, research ships, and marine mammal enthusiasts on commercial and private vessels. Marine mammal sightings are the lowest priority observer responsibility. This task should be completed only if it does not interfere with any of your higher priority duties.

Use the Guide to Marine Mammals of Alaska to help you identify marine mammals you may see in the water. Provide detailed descriptions with comprehensive notes and sketches, to fully describe any species you encounter for the first time each cruise. Use your NMFS issued camera to take photos and video of marine mammal sightings and capture specific physical characteristics, markings, and behavioral patterns.

For more common species (e.g., Dall's porpoise), you do not need to give detailed descriptions of subsequent sightings within one cruise. If the sighting involves unusual behaviors or warrants some extra description, (e.g., Humpback whales mating), give a detailed account of your observations. *If you see, or believe you have sighted a North Pacific right whale, contact your inseason advisor as soon as possible. Other than a sighting of a North Pacific right whale, marine mammal sighting data are submitted during debriefing only.*

Marine Mammal Sighting Form Instructions

Marine mammal sighting raw data is only recorded on the Deck Form and transferred directly to the Marine Mammal Sighting paper form. The sighting paper form is not entered in ATLAS (see a Marine Mammal Sighting Form example on 14-16). If you are the second observer on a vessel, complete this form under your name and cruise number, and bring the forms back to debriefing with you.

Observer(s), Vessel Name: Write your name and your vessel's name.

Cruise number and Permit Number: Enter your cruise number and the vessel permit number.

Date: Enter year (e.g., 13), month, and day.

Local Time (24 hr clock): Log the time that the animal was first seen. Use Alaska Local Time (ALT).

Latitude: Record the latitude to tenths of minutes, if possible.

Longitude: Record longitude to tenths of minutes, if possible. Enter E or W.

Sighting conditions: Give a qualitative evaluation of the overall sighting conditions. Excellent: unlimited visibility, flat seas. Good: sighting conditions affected somewhat by glare, sea state, weather, or distance. Fair: Sighting conditions affected by a combination of problems, e.g., heavy seas, poor weather, or distance. Poor: Severely limited visibility due to high seas, poor weather, or distance.

Beaufort Scale: Use the scale of sea and wind conditions (listed on the back of the sighting form) to choose the Beaufort scale number that best describes the conditions during your sighting.

Surface water temperature: Record water temperature in degrees centigrade, rounded off to the nearest whole degree. If below freezing, enter a "-"; If above freezing, enter "+". The surface water temperature often can be obtained from the captain or fish master. Many new sonars, plotters, and net detectors will also record the surface water temperature. You could also ask the engineer; surface water temperature is taken at the engine inlet thermometer. *The conversion from Fahrenheit to Centigrade is: $C^{\circ} = (F^{\circ} - 32) / 1.8$.*

Species: Write in either the common or scientific name of the marine mammal. Make sure you indicate your level of confidence in your species identification by checking the boxes to the right of the species section. If more than one species are sighted at the same time, note any association in the comments section and fill out a separate sighting form for each species. If you cannot determine species, enter the most accurate description possible, (e.g., large whale unidentified, porpoise unidentified, pinniped unidentified, etc.).

Confidence: Select sure, likely, or unsure to describe the confidence level of your species identification. This assessment should consider if you had a good look at the marine mammal and your confidence in using reference materials to help you with the identification process.

Sighting cue: Note what first got your attention to the presence of the marine mammal.

Closest approach: Note the distance in meters of the closest approach of the marine mammal. See "Abbreviations, Conversions, and Formulas" on page A-19 for conversion factors.

Number sighted: Give the best estimate of the number of individuals observed. If you are unable to count all the animals with certainty, estimate the number seen in terms of range (e.g., Best estimate: 15, minimum present: 12, Maximum present: 20) For Dall's porpoise, note if you see splashes from more animals than you can clearly observe.

Narrative and Sketches: These are the most important sections of the form and should be completed with as much detail as possible. Everything that you observed about the animal should be entered. Draw what you actually see, not what you think the animal should look like. There are several important points that you should address to verify the species and individual marine mammal:

- **Shape and size of dorsal fin and its position on the body:** This is useful in identifying cetaceans. Also note the size and shape of the tail and flippers.
- **Length of animal:** Size is difficult to estimate at sea, so compare unfamiliar species with a species with which you are familiar. You may also compare an animal to a known length on the ship.
- **General shape of the body:** Slender or robust?

- **Shape and size of snout:** Is it long or short? Estimate the length. Is there a definite beak? Is the forehead markedly bulbous?
- **Color patterns on the fins and body:** Look for spots, stripes, patches, or mottling. With orca sightings, make sure to note the exact shape and shade of the saddle spot on dorsal side directly posterior to the dorsal fin. If possible, try to take a photo of this area. Researchers are able to identify individual orcas by the saddle patches.
- **Shape, location, and direction of blow:** In cetaceans, note whether the blow is single or double. Note where the blowhole is located on the head and whether it goes forward or goes straight up. Note the general shape of the blow, is it bushy or tall?
- **Scars and scratch marks:** Look for scars or scratch marks that will help identify the individual mammal or help determine its past behaviors. Some seals will have hook scars on their snouts and a number of orcas may have bullet wounds on the dorsal fins. This will help MML determine migratory patterns and determine behaviors of individual marine mammals.
- **Behaviors of animals:** Describe in detail the behaviors of the animals observed. If there are several animals, describe how they interact with each other. Describe their diving behavior, and whether the animals were attracted to the vessel because of fishing operations. Were they feeding on discarded fish and fish parts? If so, this should be recorded as a marine mammal interaction.

Photos/Video: Use your NMFS issued camera to take photos/video of marine mammal sightings. Try to include distinguishing marks of the individuals in your photos; scars, scratches, and the saddle patches on killer whales are useful. Check the third box if there was more than one species of marine mammals present in the sighting.

Body Length Estimate: Check the box that best represents the length of the animal(s) you observed.

Some common behaviors:

Circle all of the behaviors observed during this sighting. For a list of behaviors, (see Figure 14-11 on page 14-15).



Fishing Interactions: Do not use this section. If the marine mammals you observe are interacting with fishing operations, document this even on your deck form and enter this information in the Marine Mammal Interaction and Specimen Form in ATLAS.

Silhouettes: On the back of the Marine Mammal Sighting Form are a number of silhouettes of the common marine mammals found in the North Pacific. Circle the silhouettes that best represent the mammal you observed.

MARINE MAMMAL SIGHTINGS AND INTERACTIONS AT PROCESSING PLANTS

Marine mammals are often present by shoreside plants and floating processors. Marine Mammal Sighting Forms can be filled out by both vessel and plant observers, but this is a low priority duty and must not interfere with any other higher priority duties. Marine mammal interactions may also occur and this information should be recorded on a Deck Form and transferred to the Marine Mammal Data Form in ATLAS. Interactions that occur on a vessel must be documented by the vessel observer (e.g., a Steller sea lion goes up the vessel's stern ramp and feeds off fish stuck in the net). If the interaction directly involves the plant (e.g., a Steller sea lion feeds off cod in totes on the dock), then the plant observer is responsible for documenting this information on the Marine Mammal Data Form.

| Small Cetaceans | Large Cetaceans | Pinnipeds |
|--|---|---|
| <p>Bow riding-- Animals swim beside the bow or in the bow wave of a moving vessel.</p> <p>Leaping entirely out of the water-- Animal jumps fully clear of the surface of the water (as opposed to merely breaking the surface of the water), not for forward locomotion but for other reasons (known only to them).</p> <p>Porpoising-- Animal raises its body to be nearly or fully out of the water while traveling forward at a fast rate of speed, usually in a fluid, arching motion.</p> <p>Rooster-tailing-- Animal surfaces at high speed creating a spray of water in front and over the top of the animal which looks like a rooster's tail. Usually seen only in Dall's porpoise.</p> <p>Slow rolling-- Animal comes to the surface to breathe, with the blowhole and dorsal area usually showing, and then rolls back underwater.</p> | <p>Blow visible from a distance-- Blow can be seen from more than 500 meters away. Usually only seen in certain large cetaceans.</p> <p>Breaching-- Used for larger cetaceans (orca sized and larger). The whale accelerates forward underwater and then jumps free of the water, sometimes fully clearing the water's surface, and then lands on the surface of the water, creating a large splash.</p> <p>Flipper slapping-- Whale floats or swims at the surface, turns on its side and slaps one pectoral fin against the water, either once or several times in quick succession.</p> <p>Group feeding-- Seen primarily in humpback whales, when they coordinate feeding by lunging out of the water with their mouths open, engulfing fish and water.</p> <p>Lob-tailing-- Whale raises its tail flukes up out of the water and slaps them down against the surface with great force. This may occur once or be repeated many times.</p> <p>Spy-hopping-- Whale is vertical or upright in the water and raises its head up out of the water, usually with its eye showing.</p> <p>Tail raised on dive-- When diving, the whale's entire tail lifts completely above the water before going underwater.</p> <p>Side and stern wake riding-- Whale is riding in the wake created midships along the side of the vessel, or the wake created by the stern.</p> | <p>Jug handle-- Seal or sea lion floats on its side with one front flipper and one rear flipper above the water, creating what looks like a handle.</p> <p>Porpoising-- Pinniped is swimming fast, jumping at least partially out of the water in fluid, arching motions. This swimming pattern resembles that of dolphins or porpoises seen at a distance.</p> <p>Rafting-- A group of pinnipeds resting at the surface together.</p> <p>Spooked from haulout-- Pinnipeds which had been resting on beach, rocks or ice, dove into the water due to your vessel's interaction with them.</p> <p>Vocalizing-- Pinniped making directed noises at you or at another pinniped.</p> |

Figure 14-11: Marine Mammal Behavioral Descriptions

FORM 11US (POP)

MARINE MAMMAL SIGHTING



NOAA/NMFS/AFSC/NMML
Platforms of Opportunity
7600 Sand Point Way NE
Seattle, WA 98115

| | | | | | | | | | | | |
|---|-----------|-----------|---|-----|---------------------------|--|----------|----------------|--|-------------------------|--|
| Observer(s) <u>Danny Ocean</u> | | | Vessel Name <u>Kashmir</u> | | | Cruise Number <u>25101</u> | | | Permit Number <u>9601</u> | | |
| year | month | day | local time (24 hr. clock) | +/- | GMT | latitude | N/S | longitude | E/W | | |
| <u>23</u> | <u>07</u> | <u>16</u> | <u>13:45</u> | | | <u>55°43'</u> | <u>N</u> | <u>171°26'</u> | <u>W</u> | | |
| Sighting Conditions: <input checked="" type="checkbox"/> excellent <input type="checkbox"/> good <input type="checkbox"/> fair <input type="checkbox"/> poor | | | Beaufort <u>1</u> | +/- | water temp. <u>8.3</u> °C | Species (Please fill out a form for each species) <u>Humpback Whale</u> | | | confidence <input checked="" type="checkbox"/> sure <input type="checkbox"/> likely <input type="checkbox"/> unsure | | |
| Sighting Cue <u>Saw flipper slap the water</u> <u>~ 50 m off port side</u> | | | Closest Approach (in meters) <u>50</u> m | | | Number Sighted: best estimate <u>1</u> | | | minimum no. <u>1</u> | maximum no. <u>1</u> | |

Narrative: Make identifications only on specific features seen. Mention them here. Include body features, markings and coloration, associated organisms, elaborate on behaviors, etc. The most valuable sightings contain a good amount of detailed information.

I first noticed the flipper slap the water. Also saw the small dorsal fin at same time as blow which was tall and broad. The whale dove twice in 10min, on the last dive the flukes were visible. Estimated size about 50 ft. Dark coloration with white undersides on flukes and flippers. Stocky body, head/rostrum had visible knobs, small dorsal fin.

Sketches: When possible, make a sketch noting pigmentation, anatomical features, scarring, posture, anatomical anomalies, group positioning, etc. (see silhouettes on other side).

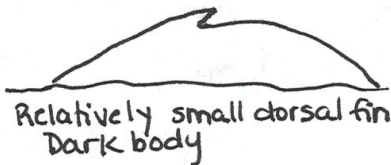

BODY LENGTH ESTIMATE

- <3m (10')
- 3-8 m (10-25')
- 8-16 m (25-50')
- 18-26 m (50-80')
- >26 m (>80')

Some common behaviors
(check all that apply)

SMALL CETACEANS

- Bow riding
- Leaping entirely out of water
- Porpoising (swimming fast, body out of the water)
- Rooster-tailing (usually a Dall's porpoise cue)
- Slow rolling

LARGE CETACEANS

- Blow visible from a distance
- Breaching
- Flipper slapping
- Group feeding
- Lob-tailing
- Spy-hopping
- Tail raised on dive
- Side wake riding
- Stem wake riding

PINNIPEDS

- Jug handle (flippers in air)
- Porpoising (swimming fast, at least partially out of the water)
- Rafting
- Spooked from haulout
- Vocalizing

Fishing Interactions

Please fill out the Marine Mammal Interaction and Specimen Form for all fishing interactions

- Contact with gear
- Contact with vessel
- Entangled in gear
- Feeding on discards
- Feeding from gear
- Following vessel while fishing
- Swimming near gear

Photos/Video (optional)
 photographs (list filenames) took 5 pics with NMFS camera

video (list filenames) short video of sighting

Check here if there was more than one species of marine mammal present at this sighting

Form 11US : version 1 : 19 June 2013

Figure 14-12: Marine Mammal Sighting Form Example (front side)

These are silhouettes of most genera of marine mammals known to occur in and around North America. Subtleties exist between closely related genera. Care should be taken in identifying species. Assessing one's level of confidence with copious notes and observations is more valuable than a brief misidentification. **Please circle appropriate silhouette(s).**

Common cetacea surface silhouettes (not to scale)

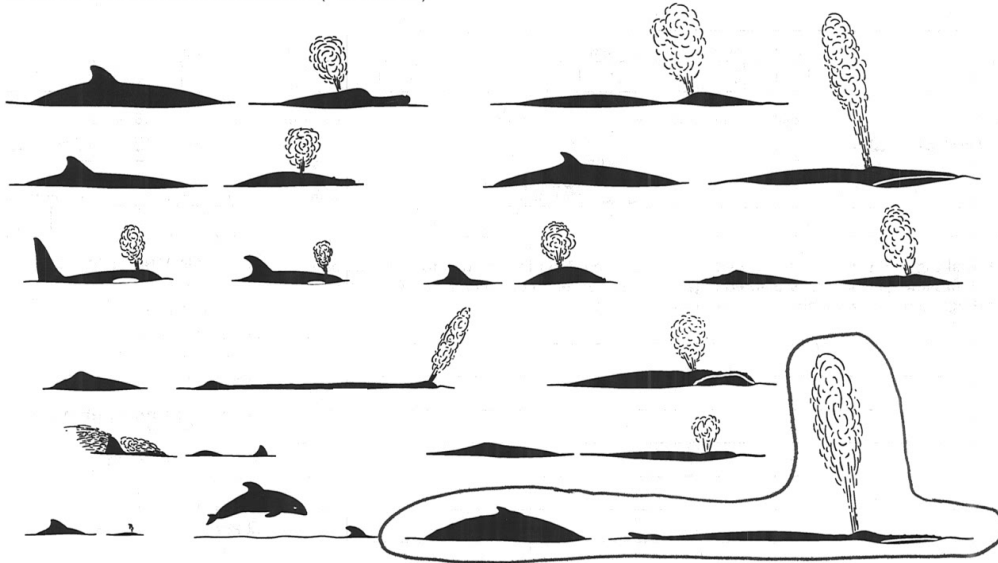

Common other marine mammal surface silhouettes (not to scale)

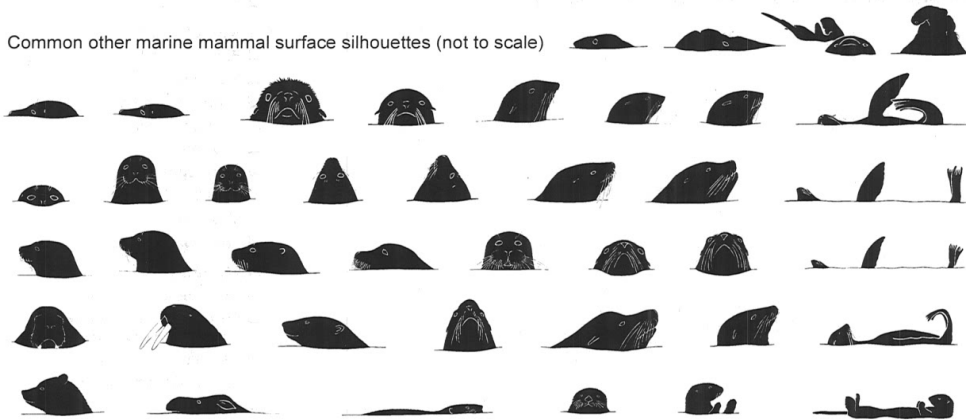

| BEAUFORT SCALE (Sea Condition) | wind | wave height |
|--|-------------|--------------------|
| 0 glassy, calm | 0 , 1 kts | calm |
| 1 light ripple | 1 < 4 kts | light air 1/4' |
| 2 small wavelets | 4 < 7 kts | light breeze 1/2' |
| 3 scattered whitecaps | 7 < 11 kts | gentle breeze 2' |
| 4 small waves, frequent whitecaps | 11 < 17 kts | moderate breeze 4' |
| 5 moderate waves, many whitecap | 17 < 22 kts | fresh breeze 6' |
| 6 all whitecaps, some spray | 22 < 28 kts | strong breeze 10' |
| 7 breaking waves, spindrift | 28 < 34 kts | near gale 14' |
| 8 medium high waves, foamy streaks | 34 < 41 kts | gale 18' |
| 9 high waves, dense foamy streaks | 41 < 48 kts | strong gale 22' |
| 10-12 not meaningful (time to go home) | | |

Figure 14-13: Marine Mammal Sighting Form Example (back side)

DECK FORM

| | | | | | |
|----------|--------|--------|----------|-------------|--|
| Date | Cruise | Permit | Haul No. | Offload No. | Page <u>4</u> of _____ for Vessel/Plant |
| 12/12/23 | 21996 | 2121 | 204 | | Page <u>1</u> of <u>2</u> for Haul/Offload |

| | | | | |
|---------------------------------|--------------------------------|----------------------------|--|---|
| Sample #: <u>2</u> | Sub-Sample #: | Sample Size: <u>162.17</u> | <small>Kgs Segments pots</small> | # of Sampled Hooks: |
| Presorted <input type="radio"/> | Combined <input type="radio"/> | | | No Fish in Sample <input type="radio"/> |

| Species | Sex | # | Weight | % ret. | Length, viability, injury, specimen, tally data, measurements, bird observations, sample design, notes: |
|----------------------|-------------------------------------|------------|---------------|-------------------------------------|---|
| ----- KEYPUNCH ----- | <input checked="" type="checkbox"/> | <u>422</u> | <u>162.17</u> | <input checked="" type="checkbox"/> | |
| Yellowfin Sole | | <u>92</u> | <u>34.96</u> | <u>100</u> | |
| Flathead Sole | | <u>4</u> | <u>1.68</u> | <u>100</u> | |
| Alaska Plaice | | <u>13</u> | <u>12.35</u> | <u>100</u> | |
| Starfish | | <u>16</u> | <u>2.56</u> | <u>0</u> | |
| P. Cod | | <u>11</u> | <u>21.67</u> | <u>100</u> | |
| Rock Sole U. | | <u>111</u> | <u>35.52</u> | <u>100</u> | |
| Rock Sole U. | | <u>126</u> | <u>40.32</u> | <u>100</u> | |
| N. Rock Sole | | <u>22</u> | <u>6.96</u> | <u>100</u> | |
| Yellow I.L. | | <u>5</u> | <u>5.15</u> | <u>0</u> | |
| Brittle Star | | <u>22</u> | <u>1.00</u> | <u>0</u> | |

Tally K/P

| | | | | |
|---------------------------------|--------------------------------|--------------|--|---|
| Sample #: | Sub-Sample #: | Sample Size: | <small>Kgs Segments pots</small> | # of Sampled Hooks: |
| Presorted <input type="radio"/> | Combined <input type="radio"/> | | | No Fish in Sample <input type="radio"/> |

| Species | Sex | # | Weight | % ret. | Length, viability, injury, specimen, tally data, measurements, bird observations, sample design, notes: |
|----------------------|-------------------------------------|---|--------|-------------------------------------|---|
| ----- KEYPUNCH ----- | <input checked="" type="checkbox"/> | | | <input checked="" type="checkbox"/> | |
| | | | | | |
| | | | | | |
| | | | | | |
| | | | | | |
| | | | | | |
| | | | | | |
| | | | | | |
| | | | | | |
| | | | | | |
| | | | | | |

Marine Mammal Interaction
Haul 204 - Freshly dead mammal in codend, body intact, fresh blood flowing from mouth
 ID - Black stocky body, white belly, light dorsal fin. Flukes with white edge.
 Sex - M
 Sp# Specimen type
 1 - Deep Tissue sample
 2 - Photos - 5 pics
 3 - Standard Length - 223cm
 4 - Curvilinear Length - 267cm

Tally K/P

Ver. 2016

Figure 14-14: Marine Mammal Interaction Raw Data Collection Example From a Trawler.

| Vessel/Plant Name | Daily Notes |
|--|-------------|
| Lady Starlight | 12/12/23 |
| <p>- Sampled Hauls 202, 203, and 204. Haul 203 was an otolith haul. No issues with Hauls 202 and 203, 5 and 4 samples collected respectively.</p> <p>- Haul 204: While watching the codend being dumped, a small dead porpoise came out and went into the tank. The deck crew stopped the dumping and managed to hoist it up. I had to skip sample 1 for this haul to collect specimen data from the mammal. I determined it was a Dall's porpoise, black, stocky body with white undersides, a very light dorsal fin and a faint white edge on its flukes. It was a male. I collected a deep tissue sample which is stored in the boat's freezer.</p> <p>Took both standard and curvilinear lengths and 5 pictures with my NMFS camera. The crew helped me dump it overboard. Specimen collection details are recorded on deck form pg 4. I have sent a message to my inseason advisor with details of this marine mammal take.</p> | |
| <div style="border: 1px solid black; padding: 5px;"> <p>Document marine mammal interactions in your logbook. Include a detailed description of your observations and any information that might have not been captured when recording the raw data on a deck form. Remember that any freshly caught marine mammal must be reported immediately to your inseason advisor. Your detailed daily notes will help you in reporting all the pertinent information.</p> </div> | |

Figure 14-15: Marine Mammal Interaction Daily Notes Example.

DECK FORM

| | | | | | |
|----------|--------|--------|----------|-------------|--|
| Date | Cruise | Permit | Haul No. | Offload No. | Page <u>10</u> of _____ for Vessel/Plant |
| 09/18/23 | 22001 | 0128 | 5 | | Page <u>2</u> of <u>3</u> for Haul/Offload |

| | | | | | |
|---------------------------------|--------------------------------|-----------------------|--|---------------------|---|
| Sample #: <u>3</u> | Sub-Sample #: _____ | Sample Size: <u>3</u> | <small>Kgs Segments pots</small> | # of Sampled Hooks: | No Fish in Sample <input type="radio"/> |
| Presorted <input type="radio"/> | Combined <input type="radio"/> | | | | |

| Species | Sex | # | Weight | % ret. | Length, viability, injury, specimen, tally data, measurements, bird observations, sample design, notes: |
|----------------------|-----|----|--------|--------|---|
| ----- KEYPUNCH ----- | X | 47 | 22.40 | X | Sablefish - (31) D/O - L = 2 Turbot - □ (4) → (3 just lips) Bathyrāja - □ (4) SS Thornyhead - □ (1) (6) D/O - Kam/Arrow - L (2) |
| Sablefish | | 31 | 0 | 93 | |
| Turbot | | 1 | 4.60 | 0 | |
| Turbot | | 3 | 0 | 0 | |
| SS Thornyhead | | 2 | 3.50 | 96 | |
| SS Thornyhead | | 2 | 3.20 | 96 | |
| SS Thornyhead | | 2 | 0 | 96 | |
| Arrowtooth | | 2 | 5.10 | 0 | |
| Aleutian SK. | | 1 | 3.10 | 0 | |
| Aleutian SK. | | 1 | 2.90 | 0 | |
| Bathyrāja | | 2 | 0 | 0 | |

Two interaction types are documented in this example: Feeding On Catch (Not Yet Landed) and Deterrence Used. Both interactions must be entered in the Marine Mammal Interaction Form in ATLAS.

Tally K/P

47

| | | | | | |
|---------------------------------|--------------------------------|--------------------|--|---------------------|---|
| Sample #: <u>3</u> | Sub-Sample #: <u>301</u> | Sample Size: _____ | <small>Kgs Segments pots</small> | # of Sampled Hooks: | No Fish in Sample <input type="radio"/> |
| Presorted <input type="radio"/> | Combined <input type="radio"/> | | | | |

| Species | Sex | # | Weight | % ret. | Length, viability, injury, specimen, tally data, measurements, bird observations, sample design, notes: |
|----------------------|-----|---|--------|--------|---|
| ----- KEYPUNCH ----- | X | 5 | 15.00 | X | Male Killer whale feeding off the line, eating turbot, 3 out of 4 in my tally. Bagged-off line, whale left after 30min Took 7 pics - Black body, distinct light saddle patch behind dorsal fin, white patch under mouth, behind the eyes and on belly |
| Sablefish | | 1 | 3.50 | 93 | |
| Sablefish | | 1 | 3.90 | 93 | |
| Sablefish | | 2 | 3.60 | 93 | |
| Sablefish | | 1 | 4.00 | 93 | |

Tally K/P

Ver. 2016

Figure 14-16: Marine Mammal Interaction Raw Data Collection Example From a Longliner.

DECK FORM

| | | | | | |
|---------|--------|--------|----------|-------------|--|
| Date | Cruise | Permit | Haul No. | Offload No. | Page <u>37</u> of _____ for Vessel/Plant |
| 5/23/23 | 21208 | 2016 | 37 | | Page <u>4</u> of <u>4</u> for Haul/Offload |

| | | | | |
|---------------------------------|--------------------------------|--------------|-------------------------|---|
| Sample #: | Sub-Sample #: | Sample Size: | Kgs Segments pots | # of Sampled Hooks: |
| Presorted <input type="radio"/> | Combined <input type="radio"/> | | | No Fish in Sample <input type="radio"/> |

| Species | Sex | # | Weight | % ret. | Length, viability, injury, specimen, tally data, measurements, bird observations, sample design, notes: |
|----------------------|-----|---|--------|--------|---|
| ----- KEYPUNCH ----- | X | | | X | <p>Humpback whale entangled in buoy line seen during set retrieval. Line appeared tightly wrapped behind head and loosely around its tail.</p> <p>Crew cut multiple wraps of line, all buoys were recovered, no gear lost. Whale swam away free with no gear attached to it. Whale's back had abrasions/ chafing.</p> |
| | | | | | |
| | | | | | |
| | | | | | |
| | | | | | |
| | | | | | |
| | | | | | |
| | | | | | |
| | | | | | |
| | | | | | |

Tally K/P

| | | | | |
|---------------------------------|--------------------------------|--------------|-------------------------|---|
| Sample #: | Sub-Sample #: | Sample Size: | Kgs Segments pots | # of Sampled Hooks: |
| Presorted <input type="radio"/> | Combined <input type="radio"/> | | | No Fish in Sample <input type="radio"/> |

| Species | Sex | # | Weight | % ret. | Length, viability, injury, specimen, tally data, measurements, bird observations, sample design, notes: |
|----------------------|-----|---|--------|--------|--|
| ----- KEYPUNCH ----- | X | | | X | <p>Humpback - Small dorsal fin, very large flippers & fleshy knobs on head. Broad flukes with scalloped edges & white underside.</p> |
| | | | | | |
| | | | | | |
| | | | | | |
| | | | | | |
| | | | | | |
| | | | | | |
| | | | | | |
| | | | | | |
| | | | | | |

Tally K/P

Ver. 2016

Figure 14-17: Marine Mammal Entanglement Interaction Raw Data Collection Example.

| Vessel/Plant Name | Daily Notes |
|-------------------|--|
| Falkor | <p>5/23/23 - While waiting for sample 3, Haul 37, I sighted a humpback whale at the surface entangled in the buoy line near a couple of buoys as gear was being retrieved. The whale appeared tired & would rest at the surface, breathe, bob up & down for ~45 seconds then dive for ~2min at a time. The buoys never left the surface when it dove. The buoy line was wrapped twice directly behind its head and very tight, as you could see it pinching its skin. Another wrap was loosely strung around its tail fluke. There were ~5 meters of rope between the wraps on the whale and the buoy.</p> |
| | <p>The crew decided to cut the rope at the roller & then approached the resting whale to cut the remaining gear free. This was done with a kn knife attached to the end of a boat hook. When the whale stayed @ the surface long enough, the deck hand cut the 2 tightly wrapped ropes. When these strands were cut they snapped completely. We approached again & the loose wrap that was around the tail fluke was now tight, but the whale appeared to have much more mobility & each breath was more forceful. The last visible rope was cut, & when the rope snapped the whale pushed hard with its flukes & dove. The line that terminated at the buoys came free & the gear was brought onboard. No gear was lost.</p> |
| | <p>I am confident that no trailing gear remained attached to the animal after the final cut to the buoy line was made. The water was clear enough, & the whale was on the surface long enough to clearly see that the whale was free from gear from head to tail fluke. I did observe red abrasions/chafing caused by the line on the whale's dorsal side between the dorsal fin and the flukes.</p> |
| | |
| | |
| | |
| | |

Figure 14-18: Marine Mammal Entanglement Daily Notes Example.

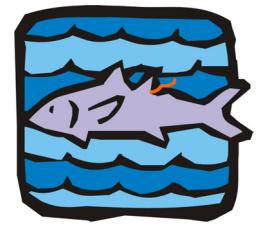

TAGGED FISH AND CRAB

Table of Contents

| | |
|--|------|
| Priorities | 15-1 |
| Introduction | 15-1 |
| Tags | 15-1 |
| Electronic Tags | 15-2 |
| Tagged Salmon | 15-2 |
| Tagged Crab | 15-3 |
| Tagged Fish and Crab Form Instructions | 15-3 |
| Tagged Fish and Crab Guidelines | 15-6 |

PRIORITIES

- Identify tagged organism to species.
- Collect pertinent biological data and capture location.
- Complete tagged fish information form.

INTRODUCTION

Fish and crab are tagged for a variety of reasons. Currently there is research being conducted on fish migration, stock separation, fishing related mortality, and population dynamics. These studies are being conducted by the International Pacific Halibut Commission, NMFS, the University of Washington, and the Alaska Department of Fish and Game. Data from tagged fish and crab are vital to the success of these studies. Data collection by observers is an excellent way for fishery biologists to receive this information.

When you arrive at a plant or vessel you should inform the crew that externally tagged fish or crab should be saved for you. *Remind the crew that tags are less useful if they are returned without accompanying information on the capture location and biological attributes, particularly size.* If vessel or plant personnel give you an external tag or an externally tagged animal, you should write down the person's name and address so they can receive a reward for returning the tag. If you are given just the tag without the animal, collect as much information as possible about the animal. For example, find out what species the tag was from, where it was caught and what haul it was in. Observers cannot collect rewards for tags they submit. If you find an externally tagged fish or crab in your sample list the captain as the person who found it.

When externally tagged fish or crab are encountered, collect the tag (except from live king crab) as well as pertinent biological information and record the capture location. If you are busy completing other tasks put the tagged fish or crab aside and collect the information after your sample is complete. Collecting information from tagged fish or crab does not take precedence over other sampling duties, but is an important part of your job.



Species that have been tagged include, but are not limited to, Atka Mackerel, Black Rockfish, Pacific Cod, Pacific Halibut, Pacific Sleeper Shark, pollock, Sablefish, salmon, Shortspine Thornyhead, Greenland Turbot, Yellowfin Sole, Alaska Skate, Big Skate, Spiny Dogfish, Tanner crab and king crab. These species may have an external tag on the dorsal surface or on the gill cover, or there may be an internal tag in the snout of the fish. See "Tagged Fish and Crab Guidelines" on page 15-6.

Tags

Most external tags are "spaghetti" tags and consist of a monofilament strand covered in brightly colored plastic attached to the fish either as a loop or through an anchoring mechanism such as a barbed tip. Tag ID numbers and contact information are usually printed on the tag. On larger individuals, e.g., skates and sharks, tags may not be immediately obvious. Some fish may have other types of tags, such as plastic discs or plates.



Electronic Tags

While spaghetti tags serve only to mark a fish, electronic tags capture data such as depth and water temperature, providing information about fish behavior and marine environmental conditions. These tags are very expensive and large monetary awards are usually offered for their return. Observers are not eligible for these awards. If you are given one of these tags by a crew member, make

sure that you obtain all contact information required on the Tagged Fish and Crab Form!

TAGGED SALMON

Tagged salmon have coded-wire tags embedded into their snouts. Coded-wire tags are about 1mm in length, and have a distinct code (usually a series of slashes at different intervals) engraved in them. *Salmon that may have coded-wire tags can be identified by a missing or clipped adipose fin.* Collect snout specimens from tagged salmon following these guidelines:

Bering Sea Pollock catcher processors and motherships:

- Collect a Chinook or Chum Salmon snout from only those tagged Chinook or Chum Salmon that are selected for genetic samples.
- Collect snouts from all other tagged salmon species encountered in your salmon retention count.

Bering Sea Pollock catcher vessels:

- Collect salmon snouts from all tagged salmon species within your species composition samples.

GOA Pollock catcher vessels:

- Collect salmon snouts from all tagged salmon species within your at-sea species composition sample.
- Collect salmon snouts from all tagged salmon species in your offload salmon retention count.

Plants receiving Bering Sea Pollock deliveries:

- Collect a Chinook or Chum Salmon snout only from tagged Chinook or Chum Salmon selected for genetic samples.

- Collect snouts from all other tagged salmon species encountered in the pollock delivery.

All non-pollock vessels:

- Collect salmon snouts from all tagged salmon species within your species composition samples.

Salmon Snout Collection Method

To remove the salmon snout, make a cut one centimeter behind the eye down through the head to the base of the upper jaw. *It is important to cut far enough behind the eye to ensure that the embedded coded-wire tag is captured.*



You do not need to include the lower jaw since tags are placed in the upper snout.

Follow these instructions when collecting salmon snouts:

- Once you have removed the salmon snout, fill out the Bag and Tag Specimen Collection Label and keep it with the snout. See the Bag and Tag Specimen Collection Label example on page 15-3 for how to complete the label.
- Place the snout in one of the plastic bags you were issued and store the specimen using one of these two options:
 1. Option 1: If freezer space is available, and you are able to keep the specimen frozen until you drop it off at a field office, place the snout and the collection label in the bag and freeze it.
 2. Option 2: If freezer space is not available and/or you can't keep the specimen frozen, place the snout in the collection bag and put enough salt to completely cover it. The snout must be fully packed in salt to preserve it. Double bag the salted snout and place the collection label in the second bag to keep it away from the snout.

| Bag and Tag Specimen Collection Label | | | | | | |
|---------------------------------------|------------------------------------|--------------------------------------|--|-----------------------------------|----------------------------------|--|
| Cruise | Permit | *Trip No. | Haul No. | Offload No. | Sample No. | S-Smpl No. |
| 21542 | 2053 | | 14 | | | |
| Cruise No. If not collected by lead: | | | *location information for trip level collections | | | |
| Species Code: 222 | | Species Name: Chinook salmon | | | | |
| Reason for Collection | | | | | | |
| ID Verif. <input type="radio"/> | Out of Range <input type="radio"/> | Training Spec. <input type="radio"/> | Salmon Snout <input checked="" type="radio"/> | Mammal Part <input type="radio"/> | Bird Spec. <input type="radio"/> | Other Describe in Comments <input type="radio"/> |
| Comments: | | | | | Specimen No. or Barcode | |
| | | | | | 32 | |

Recording Tagged Salmon Data on the Length and Specimen Form

Raw biological data from your tagged salmon are recorded on your Deck Form. Salmon snouts are recorded as specimen code 12 - "Snout".

- Record the specimen's length and weight on the Length and Specimen Form as specimen code 3 - "Length/Weight".
- The specimen code 12 - "Snout" must be recorded with the same specimen number as its corresponding Length/Weight specimen.
- The tagged snout samples are turned in at debriefing.

See "Example of a Bering Sea Pollock Offload with a Tagged Salmon" on page 15-7 for an example of how to record these data on a Deck Form.

TAGGED CRAB

King crab are tagged with external spaghetti tags which are found in between the abdominal flap and the posterior edge of the carapace. If you find a live tagged king crab, record the pertinent information but do not remove the tag. King crab should be released with the tag intact so they can be captured and identified again. If you find a dead king crab, remove the tag and return it to NMFS with the pertinent information.

TAGGED FISH AND CRAB FORM INSTRUCTIONS

Complete a Tagged Fish and Crab form for every tag that you find or is given to you. *Do not fill out this form for salmon snout specimens.* Complete as much information as possible, and remember that capture location and size are critical pieces of information. If a crew member gives you only a tag (instead of the fish or crab), ask them for the information needed. Any information that can be used to estimate a capture location is valuable (even if it is a very rough estimate, such as a NMFS statistical area). Be clear and concise in your descriptions, and affix the tag to the form. Remember to include the tag serial number on the form. Often, tags are lost in processing and without a copy of this information, the rest of the data on the form are useless. *Otoliths from tagged fish that are found outside of your sample do not get entered into ATLAS or recorded on the paper Length and Specimen Form.*

Cruise Number, Vessel/Plant Permit, Haul/Offload Number, Gear Type: Cruise numbers are issued during training or briefing. Tagged specimens should be recorded under the lead observer's cruise number. Vessel/plant permits are listed on page A-31. Enter the haul or offload number from which the tagged fish was found. Enter the gear type for the vessel.

Observer Name and Vessel/Plant Name: Write your full name and the name of the vessel on the lines provided at the top of the form. Tagged specimens should be recorded with the lead observer's name.

Reward Recipients Name and Shipment Address: The recipient's name and address are important fields on this form. Tagging agencies provide incentive gifts such as hats and t-shirts to encourage participation in these programs. Most programs using electronic tags offer monetary reward. The recipient's address should be a permanent mailing address, not the address of a processing plant. Tag rewards are often sent 3-6 months after you turn in the paperwork!

Species and Tag Prefix Number: Enter the species name for the tagged fish and record the numbers (if legible) on the tag.

Captain's Signature and Printed Name: Ask the captain to sign and print his name. If the captain does not want to provide a signature, the Observer Program may not be

able to release the tag and associated data to the tagging agency.

Date of Capture, Time of Capture, Depth, Capture Location, NMFS area, Source of Information: Record capture information to the best of your ability. If you found the tag during a sample, this information can be taken from the vessel logbook and your haul forms. If the tag was found by a crew member, you may be able to use to the log book information if the tag was a recent discovery. However, it is common for crew to give an observer tags encountered during unobserved trips. In these situations any information the crew can provide is beneficial to the data user.

Sex, Gonad Maturity, Length, Weight, General Appearance, Condition of Tagging Wound, Comments: If you have the fish in hand, record this information. Determining the maturity level is subjective. A spawning fish will release eggs or sperm when squeezed. A mature fish will have gonads that are clearly visible and have substance, whereas immature gonads may be hard to distinguish from other organs. If you were given only the tag and did not have a chance to examine the fish, record this in the comments section.

Tag and Otolith Vial: Remove the otoliths and tape the vial to the fish form along with the tag. If the tagged fish was a randomly selected otolith specimen the otoliths should stay with the data set and not be included with the tag. *Record only the vial number instead. Otoliths from tagged fish that are found outside of your sample or that are not part of your sex/length fish do not get entered into ATLAS or recorded on the paper Length and Specimen Form.*

Tagged Fish and Crab Form

| Cruise No. | Vessel / Plant Permit | Haul / Offload No. | Gear Type |
|------------|-----------------------|--------------------|--------------|
| 26420 | 12345 | Haul 14 | 8 - longline |

Observer Name: WALLY OBSERVER

Vessel / Plant Name: FISHY II

Reward Recipient's Name: JOHN J. SKIPPER
(Vessel or Plant Personnel)

Reward Shipment Address: 555 W. 55TH AVE
ANCHORAGE, AK.
99513

Species: SABLEFISH Tag Prefix and Serial No.: BC9622726
(e.g. PCA 00392)

I authorize NMFS to provide this form and the tag to the tagging Country/Agency

John J. Skipper John J. Skipper
(Captain/Owner Signature) (Captain/Owner Printed Name)

Date of Capture: 03-22-23 Time of Capture: 1430 Depth (F): 280

Capture Location: Latitude (N): 53°39.55' Longitude: 164°34.61' E/W (W)

NMFS or ADF&G Area: _____ (if Latitude / Longitude is unknown)

Source of Capture Information: Vessel Log
(e.g. vessel log, navigation equipment, crew member, plant personnel, etc.)

Sex: MALE Gonad Maturity (immature, mature, spawning) MATURE

Length (cm): 71 Weight (kg): 3.8

General Appearance (poor body condition, good body condition): good body condition

Condition of Tagging Wound (healthy healed tissue, open wound): open w/ no infection

Other Comments: only one otolith recovered, vial # 167401

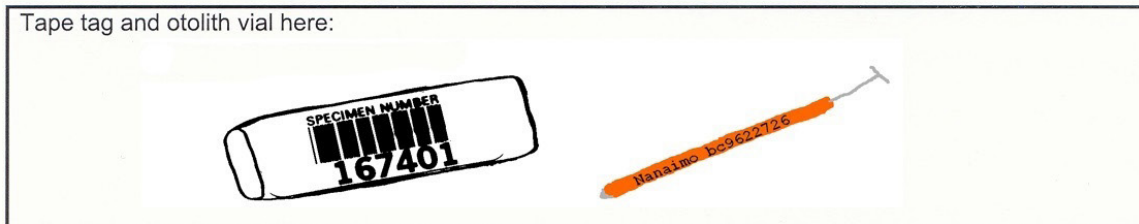

Figure 15-1: Tagged Fish and Crab Form (example)

Halibut

If fish is alive:

- remove tag
- measure fish
- weigh fish if possible
- note body condition
- note condition of tagging wound
- complete Tagged Fish and Crab Form

If fish is dead:

- remove tag
- measure fish
- weigh fish if possible
- collect otoliths, determine sex
- note body condition
- note condition of tagging wound
- complete Tagged Fish and Crab Form

Salmon

If fish is alive or dead:

- collect data from tagged salmon as outlined on page 15-2.
- measure fish
- weigh fish
- collect scales (see “Scale Sample Protocols” on page 12-11)
- determine sex
- collect salmon snout
- complete a Bag and Tag Specimen Collection Label and place it in bag with snout

King Crab

If crab is alive:

- do not remove tag
- write down tag number
- measure crab
- weigh crab
- determine sex
- determine condition
- release crab
- complete Tagged Fish and Crab Form

If crab is dead:

- remove tag
- measure crab
- weigh crab
- determine sex
- complete Tagged Fish and Crab Form

All Other Tagged Roundfish and Flatfish (alive or dead)

- | | |
|--|---|
| <ul style="list-style-type: none"> • remove tag • measure fish • weigh fish • collect otoliths | <ul style="list-style-type: none"> • determine sex • note body condition • note condition of tagging wound • complete the Tagged Fish and Crab Form |
|--|---|

Sharks and Skates (alive or dead)

- | | |
|--|--|
| <ul style="list-style-type: none"> • remove tag • determine sex (sharks and skates are sexually dimorphic; gender can be determined by external features) • note condition of tagging wound | <ul style="list-style-type: none"> • record recovery location • complete Tagged Fish and Crab Form |
|--|--|

Figure 15-2: Tagged Fish and Crab Guidelines

KM DECK FORM

| | | | | | |
|----------|--------|--------|----------|-------------|--|
| Date | Cruise | Permit | Haul No. | Offload No. | Page <u>17</u> of _____ for Vessel/Plant |
| 01/31/23 | 14533 | 5323 | | 26 | Page <u>1</u> of <u>1</u> for Haul/Offload |

| | | | | |
|---------------------------------|--------------------------------|-------------------------|-------------------------|---|
| Sample #: | Sub-Sample #: | Sample Size: | Kgs Segments pots | # of Sampled Hooks: |
| Presorted <input type="radio"/> | Combined <input type="radio"/> | Last King-2 Last Chum-7 | | No Fish in Sample <input type="radio"/> |

| Species | Sex | # | Weight | % ret. | Length, viability, injury, specimen, tally data, measurements, bird observations, sample design, notes: |
|--|-------------------------------------|----|--------|-------------------------------------|---|
| ----- KEYPUNCH ----- | <input checked="" type="checkbox"/> | | | <input checked="" type="checkbox"/> | Vessel- Sea Eagle Observer- Syd Barrett Breaks 0200-0500 1030-1300 <u>NO</u> Deckload offload Start-01/30 @ 2330 End-01/31 @ 1450 |
| Genetics / FMA ID | | | | 58# | |
| - King | M | 56 | 2.30 | 14 | |
| Adipose present - all scales zone A | | | | | |
| - King | M | 53 | 2.10 | 15 | |
| Adipose present - all scales zone A | | | | | |
| - King (no scales) | F | 65 | 3.50 | 16 | |
| - King | F | 67 | 3.90 | 17 | |
| Adipose present - Genetics zone A | | | | | |
| FMA ID zone B | | | | | |
| - King | F | 68 | 3.80 | 18 | <div style="border: 1px solid black; padding: 5px;"> The snout will be entered with the same specimen number as the genetic specimen collected from the same fish. </div> |
| missing adipose - all scales zone C snout collected | | | | | |

Tally K/P

| | | | | |
|---------------------------------|--------------------------------|--------------|-------------------------|---|
| Sample #: | Sub-Sample #: | Sample Size: | Kgs Segments pots | # of Sampled Hooks: |
| Presorted <input type="radio"/> | Combined <input type="radio"/> | | | No Fish in Sample <input type="radio"/> |

| Species | Sex | # | Weight | % ret. | Length, viability, injury, specimen, tally data, measurements, bird observations, sample design, notes: |
|----------------------|-------------------------------------|---|--------|-------------------------------------|---|
| ----- KEYPUNCH ----- | <input checked="" type="checkbox"/> | | | <input checked="" type="checkbox"/> | Salmon Count on 01/31 @ 1450 by Roger W. & KM (plant) King- (57) Chum- [14] (8) Coho- 0 Sockeye- 0 Pink- 0 <u>End offload Genetics:</u> Last King- [9] (next King-1) Last Chum- [15] (next Chum-15) |
| | | | | | |
| | | | | | |
| | | | | | |
| | | | | | |
| | | | | | |
| | | | | | |
| | | | | | |
| | | | | | |
| | | | | | |

Tally K/P

Ver. 2016

Figure 15-3: Example of a Bering Sea Pollock Offload with a Tagged Salmon

This page intentionally left blank.

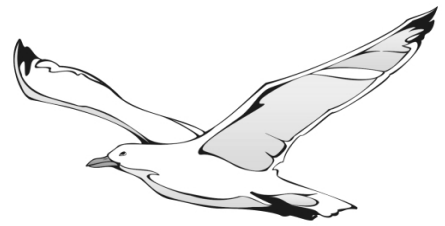

SEABIRD INTERACTIONS

Table of Contents

| | |
|--|-------|
| Priorities | 16-1 |
| Introduction | 16-1 |
| ESA-Listed Species | 16-2 |
| Birds of Conservation Concern | 16-3 |
| Incidental Take | 16-3 |
| Safe Bird Handling | 16-3 |
| Injured Birds | 16-3 |
| Protocols for Handling Injured or Sick Seabirds | 16-4 |
| Rehabilitating Short Tailed Albatross, Spectacled Eiders, and Steller's Eiders | 16-4 |
| Euthanizing Birds | 16-5 |
| Dead Bird Identification | 16-5 |
| Identifying Dead Birds | 16-5 |
| Bird Specimen Collection Protocols | 16-6 |
| What to do with birds in your samples | 16-6 |
| Tag and Bag Procedures for Retained Seabird Specimens | 16-6 |
| Monitoring Seabird Avoidance Measures | 16-7 |
| Reducing Seabird Bycatch | 16-7 |
| Other Seabird Interactions and Mortality | 16-7 |
| Vessel Strikes | 16-7 |
| Seabird Interactions with Trawl Gear | 16-8 |
| Banded Birds | 16-8 |
| Banded Bird Sightings | 16-8 |
| Documenting Seabird Interactions | 16-9 |
| Recording Bird Data | 16-9 |
| Completing the Bird Interaction, Activity and Species Form | 16-9 |
| Completing Bird Specimen and Tag Information Form | 16-14 |
| Short-Tailed Albatross Incidental Take Information | 16-15 |
| Spectacled Eider and Steller's Eider Incidental Take Information | 16-16 |
| Beaufort Sea State Descriptions | 16-17 |

PRIORITIES

- Record interactions and collect all dead birds listed under the Endangered Species Act (ESA-listed species) which include: Short-Tailed Albatross, Steller's Eiders, and Spectacled Eiders, whether in or outside your sample.
- Make every reasonable effort to rehabilitate injured Short-Tailed Albatross and other ESA-species.
- Record interactions and collect all dead banded and tagged birds.
- Record interactions and collect all dead birds outlined on page 16-5.



INTRODUCTION

Observer data are crucial for the management of seabirds and have been very useful for our U.S. Fish and Wildlife Service partners and other collaborators over the years.

Observer data collection is focused on ESA-listed seabirds and seabirds noted in the USFWS's Birds of Conservation Concern. Groundfish fisheries monitored by observers interact with a few of these species. The ESA-listed seabirds include the endangered Short-Tailed Albatross, the threatened Steller's, and Spectacled Eiders. Endangered and threatened species status are federal designations of populations that may become extinct if steps are not taken to ensure their continued existence. Birds on the USFWS Birds of Conservation Concern (BCC) list are just that – even though they may have large populations, such as the Laysan albatross, there are conservation issues that cause concern for the population.

In addition to recording seabird/fishery interactions, you may have the opportunity to report leg bands found on dead birds, document collisions of birds with the vessel superstructure, and report the methods vessels are using to reduce seabird bycatch. The collection of interaction information, especially on incidental takes of birds, is critical and is accomplished as part of your species composition sampling. Information on ESA-listed species is of high priority. All other bird duties are of low priority but the data are valuable if they can be collected. All bird data are recorded as raw data on the Deck Form and transferred to the Bird Interaction and Sightings Form in ATLAS as an “event”. An event may include an interaction with the vessel or its gear, or a sighting of a banded or tagged bird.

ESA-LISTED SPECIES

The three ESA-listed species fall into two groups of marine birds: albatross and eiders. Reliable and accurate identification, to the species level where possible, is the goal for all bird interaction information, but especially for these groups. There are special requirements for the endangered or threatened bird species.



The ESA-listed species are: Short-Tailed Albatross, Steller's Eider, and Spectacled Eider.

Under the ESA, a Biological Opinion establishes conservation measures and fisheries-specific allowable incidental take levels. Biological opinions establish an expected level of incidental take that, if exceeded, require NMFS to initiate a “consultation” with the USFWS. These are not strict quotas and do not automatically close a

fishery. Under a consultation, staff would reevaluate the expected incidental take based on changes in albatross populations, fishing patterns, and other variables. While one possible result would be a fishery closure, other actions are much more likely, such as raising the mortality level or changing seabird avoidance requirements.

Albatross



Three species of albatrosses occur in Alaskan waters: Laysan, black-footed, and short-tailed. The Short-Tailed Albatross is an endangered species. The 2021 worldwide population estimate was 8,099 short-tailed albatross.

Currently, the population estimates are approximately 1.6 million mature (2.5 million total) Laysan and 139,800 mature (ca 250,000 total) black-footed albatross. Observers are required, under the Endangered Species Act (ESA), to report all Short-Tailed Albatross takes and to save all dead individuals for return to NMFS. You must report any catches of Short-Tailed Albatross, not only those in your species composition sample, immediately. If you are at all unsure about your identification collect the albatross specimen and contact NMFS. Experts at NMFS and the USFWS will confirm the identification.

Follow the procedures for collecting specimens on page 16-5. If you cannot bring back the entire carcass, bring back at least the head! In the rare event of a take of a Short-Tailed Albatross by your vessel additional information should be included on the Bird Interaction, Activity, and Species Form (see “Short-Tailed Albatross Incidental Take Information” on page 16-15).

Eiders



Four species of eiders occur in Alaskan waters – common, king, spectacled, and Steller's. Two of these species, the spectacled and Steller's eiders, are listed as threatened under the ESA. Incidental take levels were

introduced for both threatened eider species in 2021 due to increased fishing activity in the northern Bering Sea and greater overlap with eider habitat. Although these birds are highly unlikely to be taken by gear, they may strike vessels. Bird strikes and bird storms (numerous strikes in a short time period), seem to occur in

association with bad weather, low ambient light, and the use of bright ship lights. You need to report all bird strikes involving spectacled and Steller’s Eiders. In addition, the ESA requires that you retain all carcasses that can be recovered. Follow the procedures for collecting specimens on page 16-5.

BIRDS OF CONSERVATION CONCERN

The USFWS Birds of Conservation Concern (BCC) list includes species of high conservation priority. Even though these species may have large populations, conservation issues have been identified causing concern for their population status. Birds of Conservation Concern in Alaskan Waters include the following species:

| SPECIES | |
|--|--------------------------|
| Marbled Murrelet | Yellow-billed Loon |
| Kittlitz’s Murrelet | Laysan Albatross |
| Ancient Murrelet | Black-footed Albatross |
| Whiskered Auklet | Murphy’s Petrel * |
| Red-legged Kittiwake | Mottled Petrel * |
| Ivory Gull * | Buller’s Shearwater * |
| Ross’s Gull * | Pink-footed Shearwater * |
| *These species are not found in your Beached Birds ID Guide. The guide will lead you to gull unidentified and petrel/shearwater unidentified respectively. | |

Figure 16-1: Birds of Conservation Concern Species List

INCIDENTAL TAKE

One hundred million marine birds of over 80 species occur in Alaskan waters. These birds spend most of their lives foraging at sea for small fish, squid, and crustaceans. Birds are attracted to fishing vessels because of the presence of readily available food in the form of offal, discard, and bait. The most likely seabird species to be taken in longline fisheries are the surface foragers/scavengers albatross, fulmars, and gull, and the shallow-diving shearwaters. The most likely seabird species to be caught in trawl gear are shearwaters, fulmars, and occasionally alcids (puffins, murre, etc.). The most likely seabird species to be caught in pots are murrelets and murre. The most likely seabird species to be involved

in vessel collisions are eiders (especially spectacled and Steller’s Eiders) and alcids (puffins, murre, auklets, etc.).

Birds taken during longline operations are attracted to baited hooks when the gear is set; they become hooked at the surface, are dragged underwater and drown. Other times they get hooked on the line as the gear is retrieved. If any bird comes up on a hook during sampling, regardless of when or how it was hooked, it is considered “caught” and must be included in the species composition sample. The most likely species to be caught in longline gear are northern fulmars and gulls, which constitute more than 70% of bird bycatch. The albatross species and dark shear waters are also taken regularly, although in much lower numbers.

Crewmen may try to throw birds overboard as quickly as possible. *Be sure to ask the crew (before hauling begins) to save all dead birds for you regardless of whether or not you are sampling.* Additionally, many longline fishers are concerned that catching a Short-Tailed Albatross may close their fishery thus providing an incentive for not reporting these birds. You must report any bird that lands in your composition samples and you should alert the crew to this fact.

SAFE BIRD HANDLING

Always wear heavy gloves when handling live or dead birds. Birds may carry diseases transmissible to humans. Wash your hands thoroughly after handling a bird.

All birds have sharp beaks and strong jaws that can cause serious injury. Along with wearing gloves to protect your hands, take care to protect your eyes when handling live birds. Hold the live bird at waist level to protect your face and wear safety glasses if possible.

INJURED BIRDS

Rehabilitating ESA-listed seabirds is a top priority. Please note that Short-Tailed Albatross, Spectacled Eider, and Steller’s Eider are the only species that should be rehabilitated. In most other cases the best course of action is to end the birds suffering by following the procedures for euthanizing seabirds. It is your option to euthanize the bird and collect it as a specimen, attempt rehabilitation, or return the bird to the sea.

PROTOCOLS FOR HANDLING INJURED OR SICK SEABIRDS

Safety First! Be very careful when handling live birds. Heavy rubber protective gloves are advised. All birds have sharp beaks and strong jaws that can cause serious injury.

If you encounter an injured or sick ESA-listed or BCC seabird, follow the protocols outlined below and contact your inseason advisor or NMFS staff as soon as possible.

Please note that rehabilitating seabirds should only be done for ESA-listed species.

Seabird Handling Safety

Do not attempt to recover a sick or injured seabird when it is not safe. Seabirds may become aggressive if they feel threatened. Seabirds carry diseases that are transmissible to humans. Avoid contact with bodily fluids. *Always wear gloves when handling seabirds and keep the seabird at or below your waist protecting your face.* Wear safety glasses if they are available. Clean and treat all cuts and scratches you may receive. Wash your hands thoroughly after handling seabirds.

Oiled Seabirds

Properly cleaning oiled seabirds is a highly specialized and labor intensive process. These birds cannot be properly cared for at sea. Even slightly oiled birds stand little chance of recovery. Your best course of action is to euthanize and collect the seabird, unless it is an ESA-listed species. If you have one of these, assess its condition and contact your inseason advisor. If you are not comfortable euthanizing the bird you may return it to the sea. Please record these instances in your logbook and relay them to your debriefer. Euthanizing the bird and saving the carcass supports U.S. Fish and Wildlife bilge oil monitoring and compliance programs. The specimen will be further valued by supporting other scientific uses as well. Most importantly, you end the birds suffering. Please euthanize the seabird, wrap it in aluminum foil, and save it following the bag and tag instructions (see “Tag and Bag Procedures for Retained Seabird Specimens” on 16-6).

Injured or Sick ESA-listed Birds

For apparently minor injuries (small lacerations, web tears, minor stunning, etc.), release the bird if:

- you are so advised, or

- the bird meets all the following release criteria.

Release Criteria

1. Bird can stand and walk using both feet.
2. Bird can flap both wings and there is no apparent wing droop.
3. Bird is alert, active, holds its head up and reacts to stimuli (motion, light, etc.).
4. Bird is not bleeding freely.
5. Wing and tail feathers have not been lost and are in good condition.
6. Bird is waterproof (water beads up on feathers).

Retain birds that do not meet all of these criteria!

Rehabilitating Short Tailed Albatross Spectacled Eiders, and Steller's Eiders

Take the following steps to rehabilitate the seabird:

1. Wear gloves, eye protection, and rain gear.
2. Capture the bird without jeopardizing the safety of yourself or the crew and place into a box or container. The bird should not have enough room to further injure itself.
3. Do not restrict a live bird from opening its bill with tape or a rubber band, etc.
4. Ensure adequate ventilation of the container.
5. Never put a bird in an overly warm place (e.g., engine room) or use external heat sources to dry a wet bird (e.g., hair dryer, space heater, etc.).
6. Treat a wet bird by gently blotting excess water from the bird with paper towels.
7. Keep bird inside the container in a quiet, dry place and minimize handling.
8. Contact your inseason advisor or NMFS staff immediately. Record recovery location (latitude and longitude), time, persons involved and why and how the bird was recovered. Also record when the bird eats or drinks.
9. Place a container of cool, fresh water with the bird, if the possibility of spilling is minimal.

10. Place absorbent material in the bottom of the container to minimize contact with feces. Replace the material when soiled.

11. Food may be offered if the bird is alert. Try offering a hard-boiled egg or small pieces of fish liver.

Release the bird only when advised to do so.

Transporting Sick or Injured Birds

Sick or injured birds may need to be transported. You will get specific care and transport instructions when you contact NMFS staff.

EUTHANIZING BIRDS

If the bird is seriously injured, sick, suffering, oiled or appears to be dying and it is not an ESA-listed species, you may euthanize the bird. For species noted as a Bird of Conservation Concern, attempt to contact NMFS staff before proceeding with euthanization. Note any band or tag information in your logbook.

Field Procedures for Sacrificing Birds

Administer euthanasia away from the crew. The preferred field methods for euthanizing birds are cervical dislocation (breaking the neck) and decapitation.

Cervical Dislocation

Place the bird's head, bottom of the bill down, on a flat, solid surface. Place a solid rod (stick, dowel, etc.) on the neck directly behind the head. Holding the rod firmly on the neck, seize the body in the other hand, and give a quick, definite and strong yank backwards without letting the head move. You should feel the neck stretch and break. A slow or tentative motion will not work. It may help to pull the bird's body up as well as backward. The bird may shudder or tremble for a minute. Repeat the procedure if necessary.

Decapitation

Wear gloves to reduce contact with bodily fluids. Use a large, heavy knife or ax. Cut through the neck in one stroke. This procedure is quick and minimizes suffering.

Retaining Euthanized Specimens

For all euthanized birds, follow the "Tag and Bag Procedures for Retained Seabird Specimens" on page 16-6, unless advised otherwise.

DEAD BIRD IDENTIFICATION

Identification of marine birds in the Gulf of Alaska and Bering Sea is not easy - some closely related species are virtually indistinguishable. The beached birds guide provided to you is a key developed specifically to identify dead seabirds in hand. This guide relies on the characteristics of the bill and feet, rather than plumage, which is often in a state of disarray.

Observers are asked to identify birds to the species level where possible. This is crucial for ESA-listed species and those species that could be confused with ESA-listed species (e.g., black-footed and Laysan albatross). In cases where you do not feel comfortable with your identification, use the appropriate species group. For example, you will not be able to identify immature gulls to species and should instead use the group code for "unidentified gull."

Identifying Dead Birds

- With the seabird in hand, use the Beached Birds: A COASST Field Guide to identify the bird to the species level where possible.
- At a minimum, attempt to identify albatross, eiders, murrelets, and kittiwakes to species.
- If you cannot identify a bird to species, do not guess! Key it to the highest taxonomic group to which you are confident.
- Identify gulls, dark shearwaters, and murres to group -e.g., gull unid., dark shearwater unid., and murre unidentified. If the bird is bird of conservation concern or ESA species, follow the "Tag and Bag Procedures for Retained Seabird Specimens" on page 16-6.
- Retain banded or tagged seabirds, following the "Tag and Bag Procedures for Retained Seabird Specimens" on page 16-6.
- Complete a Seabird Species Identification Form for all new species seen, for every ESA or BCC bird, and for any unidentified seabird.
- Take pictures of dead seabirds using your NMFS issued camera. These photos can be submitted as supplemental data to your Seabird Species ID Forms.

BIRD SPECIMEN COLLECTION PROTOCOLS

Seabird specimens are of high scientific value. These specimens provide critical information such as geographic range, genetic make-up, age, sex, reproductive condition, food habits, and occurrence of marine plastics to a variety of data requesters, including museums, universities and government agencies. NMFS requests that you save dead seabirds from inside or outside your samples following the specific guidelines below. It must be noted that the protocols are cruise specific.

1. All ESA-listed species: Short-Tailed Albatross, Spectacled Eider, and Steller's Eider.
2. All Laysan and Black-footed albatross.
3. All Birds of Conservation Concern (see "Figure 16-1: Birds of Conservation Concern Species List" on page 16-3).
4. Up to 5 fulmars per cruise.
5. Up to 5 shearwaters per cruise.
6. Birds that you are unable to identify.
7. Other assorted unique birds that you feel are important to collect. Contact your inseason advisor with details about the bird specimen. They will give you guidance on whether to keep it or not.
8. Collect whole birds only. Do not collect birds that are just skeletal remains or very badly damaged when they are retrieved due to sand flea damage, unless the observer needs a species ID verification.

The program requests that you save all dead seabirds outlined above. Carcasses of Short-Tailed Albatross and other rare species must be collected no matter what their condition. In the event an ESA-listed species is caught, contact NMFS staff immediately!!

What to do with birds in your samples

In the event you have a bird take inside your sample, gather the following information:

1. Drain as much water as possible from the carcass prior to weighing the bird(s). Weigh Short-Tailed Albatross individually. Other species may be weighed individually or in groups by species.



Birds are much lighter than they appear. Weights over 5 kg are extremely doubtful!

2. Look for leg bands, nasal tags, and radio tags. If the bird has any of these, see "Banded Birds" on 16-8.
3. Record species, number, and weight information on the Deck Form.
4. For birds that drop off longline gear or are thrown overboard before you have a chance to weigh them, identify them as closely as you can and enter a zero in the weight column for that individual.
5. If you see an albatross fall off the gear or thrown overboard and cannot positively identify it, you *must send an inseason message or call the field office as soon as possible*. Document all circumstances and details associated with the drop-off or discard in your logbook Daily Notes. Report the event via ATLAS and on the Bird Interaction, Activity and Species Form.
6. Collect only those birds outlined in the "*Bird Specimen Collection Protocols*".



Takes of unidentified albatross, Short-Tailed Albatross, unidentified eiders, Spectacled Eiders, or Steller's Eiders must be reported to NMFS as soon as possible. Due to the sensitive nature of an albatross take, keep this information confidential between you, the vessel, and NMFS personnel!

TAG AND BAG PROCEDURES FOR RETAINED SEABIRD SPECIMENS

Follow the instructions below for retaining seabird specimens. If you encounter an oiled bird, see additional guidelines found on 16-4. Be sure to refer to the safe-handling section for collection of specimens.

1. Stuff the mouth and throat of the bird with absorbent material (paper towels, cotton balls, etc.) and secure the beak closed.
2. Place the bird in a plastic bag.
3. For each specimen, complete a Tag and Bag Specimen Label. Be sure to record the following information on the tag: cruise number, vessel permit, haul number, species code, species name, and sample number if applicable. Include any other pertinent information in the comments field. If the specimen

is not associated with a specific haul or offload, enter the best location information (latitude/longitude or port) available to you. Specimen information on the Tag and Bag Specimen Label must match corresponding information on the Bird Specimen and Tag Information Form.

4. Place tag in the bag and close the bag securely. Place this bag in a second bag and close tightly.
5. Make tag visible from outside the bag.
6. Place double-bagged bird in the freezer.
7. Remember to retrieve the bird specimen when you reach port and take it to a NMFS office!
8. If you are collecting a specimen of an ESA-listed species, or an unidentified albatross or eider, notify NMFS staff as soon as possible.



NMFS has provided you with a bird specimen collection permit from the USFWS for birds not listed under the ESA. If you collect and ESA-listed bird, we will forward you a transport permit from the USFWS

MONITORING SEABIRD AVOIDANCE MEASURES

One of your duties aboard longline vessels is to monitor and record the types of seabird avoidance gear your vessel is using. The requirements for streamers or buoys depend on vessel size and wind condition during gear deployment. Refer to the Beaufort Sea State descriptions on page 16-17 to code wind conditions. Familiarize yourself with the requirements and performance standards listed under “Seabird Avoidance Gear and Methods For Longliners §679.24” on page 20-20.

While you are not asked to actually measure performance standards, you are asked to document whether the vessel is in compliance with requirements to deploy streamer lines or buoys while setting gear. Check the gear setting operations and record on the Observer Haul Form what type of seabird avoidance gear is being used for as many sets as possible. For more information on how to record this data on the Observer Haul Form, see page 7-22.



Document obvious deficiencies of seabird avoidance gear and differences between the seabird avoidance gear recorded in the vessel logbook and what you observe in the Daily Notes. If your observation of

the gear differs from what is recorded in the logbook talk with the captain. Document any explanations the captain provides for why avoidance measures were not followed. Follow the instructions “Reporting Potential Violations” on page 20-2.

REDUCING SEABIRD BYCATCH

Observers can play an important role in helping captains reduce seabird bycatch. An easy way to accomplish this is to let the captain know if you encounter seabird bycatch during your regular sampling duties. The vessel may make adjustments to its seabird avoidance gear based on this information. This type of immediate feedback, if the captain is amenable, can be a good measure of performance of the seabird avoidance gear.

OTHER SEABIRD INTERACTIONS AND MORTALITY

Not all incidental seabird mortality is caused by fishing gear interactions. Seabirds may be killed or injured by colliding with fishing vessels or parts thereof. Report such incidents on the Bird Interaction, Activity and Species Forms and/or Bird Specimen and Tag Information Forms in ATLAS.

Intentional killing or maiming of seabirds sometimes occurs. If you see this, document the details of the interaction on a Deck Form and in the Daily Notes section of your logbook with all necessary information. This includes date, location, species, numbers, vessel name, crew members involved in the incident and any other pertinent information. As with other violations, you should inform the captain that you witnessed this incident. This will give him the opportunity to address the issue with his crew and prevent future incidents.

Vessel Strikes

Incidents of vessel strikes range from the occasional bird found on deck to flocks of birds hitting the ship, referred to as “bird storms.” It appears that birds hit the vessel because they become confused, primarily at night during inclement weather, and when bright lights are being used. Certain vessel light configurations may increase attraction, disorientation, and collision risk for birds. There is also evidence that red steady-state lights are particularly attractive and disorienting to birds. During hours of darkness when vessels are lighted, eiders may be particularly vulnerable to collision risk.

While not a regulation or requirement, in order to reduce light distraction to birds, the U.S. Fish and Wildlife Service recommends:

- Mariners attempt to keep deck lighting to a minimum, and shield lights to direct illumination inboard and downward to the extent possible while still maintaining compliance with navigation rules.
- If red lighting is used, those lights be limited to interior spaces, and that windows be shaded to the extent practicable when indoor spaces must be lit at night.

Seabird Interactions with Trawl Gear

On trawlers, observers have reported seeing birds strike the third wire and main cables resulting in serious injury. The third wire cables are part of the trawl sonar system that consists of a unit, often called the suitcase, attached to the head rope. The suitcase sends signals to the vessel via the third wire cable. Seabirds, attracted to a stream of offal or discard, may collide with this cable. Some observers have documented dead birds wrapped around this cable near the suitcase. In addition, especially diving seabirds, may become entangled in the net wings during gear deployment and retrieval.

Because of the potential for trawl gear interactions with Short-Tailed Albatross, as well as other seabirds, NMFS and USFWS are interested in information regarding the magnitude of this problem. If you are on deck during gear retrieval, please check for seabirds wrapped around the third wire, main wire or caught in the net wings. Record these mortalities on the Deck Forms and enter them in the Bird Data Form in ATLAS.

BANDED BIRDS

Internationally, over one million birds are banded by government and scientific research institutions. Information from recovered bands are an important data source

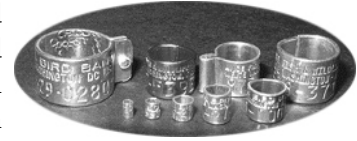

used in the management of migratory birds. The Bird Banding Laboratory (BBL) of the U.S. Geological Survey and the Banding Office of the Canadian Wildlife Service jointly manage the bird banding program in North America. Analysis of banding data allows calculation of important population parameters.

A tremendous cost is associated with banding efforts and only a small percentage of bands are ever recovered. Reporting recovered bands is extremely helpful to these researchers. Record any tagged or banded birds on your Deck Form and report the event on the Bird Interaction, Activity and Species Form and the Bird Specimen and Tag Information Form in ATLAS (see Figure 16-3 on page 16-18 and Figure 16-4 on page 16-19).

Always include the complete tag or band number, colors and configuration of plastic bands, and which leg each band was on.

If the bird is dead, label and freeze it. If this is not feasible, remove the tag or band and return it to NMFS. The tag or band is used to determine rates of wear and other information that contributes to data analysis. *Even if you cannot retain the bird specimen or bands, record all pertinent data on your Deck Forms and send via ATLAS.*

If the bird is alive, do not remove the band. Record the complete tag or band number, colors and configuration of plastic bands, which leg each band was on, and the position and date of capture, prior to releasing the bird.

Remember to take precautions to safely handle birds; see “Safe Bird Handling” on page 16-3

Banded Bird Sightings

In the course of completing your duties, you will see many birds gathered around the vessel. If you observe banded/tagged birds near or on the vessel, please document the details of this event on a Deck Form and report these data in ATLAS as a Sighting of Banded/Tagged Bird (interaction code 17). If the banded bird sighting

involves multiple banded birds or bird species, you can report these data under the same event number. *If the banded bird sighting involves a Short-Tailed Albatross, you must also fill out the Bird Interaction, Activity and Species paper form and the Bird Specimen and Tag Information paper form* (see Figure 16-3 on page 16-18 and Figure 16-4 on page 16-19). Reporting sightings of banded birds provides important information even if the band is not recovered.



All banded bird sighting events must have a Bird Tag Information specimen (specimen code 10) associated with it

DOCUMENTING SEABIRD INTERACTIONS

All bird strikes and other mortalities from interactions with gear (in and outside of your samples) that you are aware of should be reported, whether the haul was sampled or not. If a bird is found during a pollock offload, the specimen will be attributed to the vessel observer's data. All raw data must be recorded on a Deck Form. Document as much detailed information as possible about the interaction on your Deck Forms (see Figure 16-4 on page 16-20) and report these data in the Bird Data Form in ATLAS.

If you have an interaction involving a Short-Tailed Albatross, you must also fill out the Bird Interaction, Activity and Species paper form and the Bird Specimen and Tag Information paper form (if specimens are collected) in addition to entering and reporting the data in ATLAS. Complete the "Short-Tailed Albatross Incidental Take Information" questions on 16-15 and record your answers in ATLAS. Document any additional information in the Daily Notes of your logbook.

For Spectacled Eider or Steller's Eider takes, enter the data in ATLAS and complete the "Spectacled Eider and Steller's Eider Incidental Take Information" questions on 16-16. Record your answers in ATLAS and document any additional information in the Daily Notes of your logbook.

RECORDING BIRD DATA

All seabird interactions and specimen data must be documented in your Deck Forms and transmitted via ATLAS. *On boats with ATLAS, paper forms are also*

required for all Short Tailed Albatross events but not for other species. Additional instructions for entering bird data in the Bird Data Form in ATLAS start on page 18-20. The Bird Interaction, Activity and Species paper form and the Bird Specimen and Tag Information paper form are structured to mimic the way in which data are entered into ATLAS (see Figure 16-3 on page 16-18 and Figure 16-4 on page 16-19).

Completing the Bird Interaction, Activity and Species Form in ATLAS

The Bird Interaction, Activity and Species Form should be filled out when:

- You collected a specimen (either within or outside of your species composition sample).
- You witnessed a bird interaction or mortality.
- You have a sighting of a banded or tagged bird.

Each record is based on an event. For data collection purposes, an event for an sighting of a banded and/or tagged bird is when you first see the bird of interest (see Figure 16-3 on 16-18). For an interaction or mortality, an event is the moment the bird first interacts with the gear or vessel (see Figure 16-5 on page 16-20). Below are some examples of how to define an event.

1. On a longliner, the observer is tallying and sees a dead fulmar coming up on the line. The event is when the bird first interacted with the gear and was caught. Most likely, this occurred while the boat was setting the gear.
2. On a longliner, the observer is tallying and notices a gull being hooked as the line is being retrieved. The event is when the gull was hooked.
3. On a catcher processor trawler, the observer sees a dead fulmar go by on the conveyor belt while sampling. The event is when the bird was caught in the net, not when the observer encounters it while sampling. The event could have happened when the vessel was setting or retrieving the gear or while the net was actively fishing in the water.
4. On a catcher trawler vessel, a crewman collects a dead fulmar that was found in the codend. The crewman gives the bird to the observer and the bird is collected as a specimen. The event is when the fulmar was caught in the codend, not when the crewman gave the

SEABIRD INTERACTIONS: RECORDING BIRD DATA

bird to the observer.

Each event has a unique event number and an event is comprised of: 1) a Bird Interaction, 2) an Interaction Outcome, and 3) one or more bird species. *Do not fill out the paper form if you are assigned to an ATLAS vessel unless you are reporting a Short-Tailed Albatross interaction.*

On the paper form, all fields followed by a rectangular box require a numeric code entry (no written descriptions). Fields followed by an oval are check boxes; check the oval if it applies to the event and leave it blank if it does not apply. Every event must be recorded on a separate form.

Cruise, Permit, Year: Enter the cruise number supplied in your training or briefing. Vessel permits can be found on A-31.

Event Number: Enter a unique Event Number for every interaction. The event number should not be duplicated for a vessel.

Trip, Haul or Offload: A bird event may be recorded from a Trip, Haul, or Offload. select where the event occurred and the corresponding trip, haul, or offload number.

Observer Name/Vessel Name: Enter your name and the name of the vessel.

“Interaction Description” Tab:

Date and Time: Enter the date and time if the bird event was recorded during a trip. If the exact date or time is not known, record your best estimate and make a note in the Interaction Description and Comments.

Bird Location: The bird location code is the location of the bird at the time of the event.

1. AIR - The bird is in the air or flying
2. WATER - The bird is on water or diving
3. BOAT - The bird is on the boat
4. LAND - The bird is on land
5. IN GEAR - The bird is on or in the gear
6. NOT APPLICABLE - None of the other options apply
7. ON DEBRIS OR OBJECT - The bird is on debris or an object floating in the water

Fishery Location: Enter the Fishery Number Code for where the vessel was fishing at the time of the event.

1. Gulf of Alaska
2. Bering Sea / Aleutian Islands - *Do not use.*
3. Bering Sea
4. Aleutian Islands
5. Prince William Sound
6. Kodiak Island Area
7. Southeast Alaska
8. West Coast

Location During Trip or Offload: If the bird event was recorded during a trip or offload, you must record the position. If the exact position where the event occurred is not known, record your best estimate and make a note in the Interaction Description and Comments. If the event was from a haul, the position is not required; that information will be inherited from the retrieval position recorded on the haul form.

Weather Conditions During the Interaction:

Beaufort Sea Scale: Refer to descriptions of the Beaufort Sea Scale listed in Figure 16-2 on page 16-17. Select the numeric code that corresponds with the appropriate sea conditions.

Weather: Select the appropriate weather code for the weather at the time of the event.

1. SUN
2. CLOUDS
3. RAIN
4. FOG
5. SNOW
6. VARIABLE

Interaction Description and Comments: Record any additional comments or details that may help categorize the event.

“Vessel Activity” Tab:

Vessel Activity describes the vessel’s activity at the time of the event. Bird Deterrent is a list of equipment used to deter birds from interacting with the gear. Vessel Activity and Deterrent Types are listed on the second tab of the Bird Data Form in ATLAS. Unlike other fields, multiple answers are allowed. Select the appropriate vessel activities and deterrents used at the time of the event.

Vessel Activity:

Traveling: Vessel is underway, but not actively fishing

Setting: Deploying fishing gear

Offloading: Offloading Gear or Catch

Sampling: Observer sampling or tallying catch

Processing: Processing catch

Resting: Vessel not underway and not fishing

Fishing: Actively fishing

Retrieving: Hauling or Retrieving Gear

Not Applicable

“Deterrent Type” Tab:

Deterrent Used? This is a list of reasons for the presence or absence of deterrents used at the time of the event. This is not a simple Yes or No question.

1. - **Yes** - A deterrent was used
2. - **Non-Standard** - A non-typical or unlisted deterrent was used
3. - **No** - Bad Weather. Use when the vessel personnel do not put deterrents out by choice due to conditions, but deterrents may be required by regulation(Longliners)
4. - **No** - Not Required. Use when weather is bad enough that the vessel is not required to put them out(Longliners)
5. - **No** - Should Have. Deterrent not used when required.
6. - **Unknown**-You were not able to determine if a deterrent was used
7. - **Not Applicable** - Most often used for trawl and pot gear types

Following are examples of how to determine the “Deterrent Used” code.

1. On a longliner, the observer is tallying and sees a dead fulmar coming up on the line. The observer had spot checked to see if the streamer lines were deployed during the setting of that haul. Because the bird was caught during setting and the observer verified that the streamer lines were deployed, the observer lists code 1-Yes, a deterrent was used.
2. On a longliner, the observer is tallying and sees a dead fulmar coming up on the line. The observer *did not* spot check to see if the streamer lines were deployed for that set. Because the observer did not witness any deterrent used for that haul, the observer lists code 6-Unknown, you were not able to determine if a deterrent was used.
3. On a catcher processor trawl vessel, the observer sees a dead shearwater pass by on the conveyor belt. The deterrent used is code 7 - Not applicable, since trawlers are not bound by regulation to use bird deterrent devices.
4. On a longline catcher vessel, the observer is tallying and sees a fulmar swimming by the line trying to grab bait from the hooks as the gear is retrieved. The fulmar gets hooked and pulled to the rail where it is released by the rollerman. The deterrent used is code 7 - not applicable, and the deterrent type is left blank. The Interaction description would be code 8 - Gear Interaction. *Remember to include the bird in your species composition sample.*

Indicate the *Deterrent Type* under the dashed line. Deterrent types can be gear, equipment or human interactions used to deter birds from interacting with the gear.

Weights - Weights used to sink the groundline rapidly

Other-Any other equipment or method not listed to deter birds from interacting with the gear or vessel

1 Streamer Line - One streamer line deployed from the stern of the vessel

Bird Bag - One buoy or bird bag is dragged from the stern of the vessel

Lining Tube - The vessel deploys gear through an under water tube from the stern of the vessel

Discharge Offal - The vessel discharges offal in the opposite direction of the gear

Unknown Number of Streamers - You do not know the number of streamers used

Bird Bags - Two buoy or bird bags are dragged from the stern of the vessel

Water Hose - The crew sprays water directly at a bird or used sprinklers to deter birds from the vessel or gear

2 Streamer Lines - Two streamer lines deployed from the stern of the vessel

Entering Species Information

An unlimited number of bird species may be present for a specific bird event. After the interaction, vessel activity, and deterrence information have been entered, each species must be recorded. For each species you must record a count, a description of certainty for your species identification, an interaction description and an interaction outcome.

All Short-Tailed Albatross must be identified to a specific age category and you must provide a count of the number of birds in each age category.

Species Code: Record the appropriate species code. A complete list of Bird Species codes may be found in the Appendix "Species Code List - Seabirds" on A-13.

Species Name: Record the bird species.

Number of Birds: Record the total number of birds for the species listed in the interaction. This field is not filled out for Short-Tailed Albatross events. For a Short-Tailed Albatross individual counts are recorded for specific age categories.

Count Type: Describes how the total or estimated number of birds for a species was determined. Each Count Type has a corresponding numeric code that should be recorded.

1. **Specific** - An accurate count of every bird involved in the interaction
2. **Grouped** - A rough count of the species in a flock or grouping of multiple birds
3. **Estimated** - An estimation of the total number of birds for a species.

Good Look at Bird: Describes the level of the observation. This is a personal assessment of whether the bird was in plain view or not. Select the appropriate response.

Y - Yes - The bird was in plain view

N - No - The bird was seen at a glance

N/A - Not Applicable

How Certain of ID: Describes the confidence level of your species identification. This assessment should take into account if you had a good look at the bird and your confidence in using any reference materials to identify the bird. Select the appropriate response.

Y - Yes - Positive of the ID

N - No - Not positive of the ID

M - Maybe - Fairly positive of the ID

Interaction Description: Describes the bird interaction with gear, vessels, offloads, etc. Choose the most accurate description of the bird's interaction at the time of the event. If an accurate description of the interaction is not listed below, select the interaction description that most closely matches the interaction, and enter a detailed description of the interaction in the "Identifying Characteristics" comments field. Contact your inseason advisor or Observer Program staff to help you determine which interaction description is most appropriate and how best to document the unusual interaction. This can be further reviewed at debriefing. Each interaction type has a corresponding numeric code. Record this code on the form.

1. **Sighting**- Currently not in use.
2. **Third Wire, Paravane or Warp Cable Contact**- Bird came into contact with the third wire, paravane or warp cable.
3. **Rig Strike** - Bird made contact with vessel's rigging, excluding third wire, paravane, or warp cable interactions.
4. **Bird Storm**-A flock of birds strike the vessel, gantry or stack; then land on deck. A bird storm may include a rig strike. Use this for single bird strikes also.

5. **RE Deterrent** - Bird interacted with the deterrent measure/device. RE is an acronym for “Regarding.”
 6. **Land on Vessel** - Bird landed on the vessel, but not part of a bird storm, rig strike, or oiled bird event.
 7. **Oiled Bird** - Bird was oiled at sea. Does not include birds that were oiled when it contacted something on the vessel.
 8. **Gear Interaction**-The bird made some sort of contact or interacted with the gear. This does not include third wire or warp cable interactions, deterrents or ‘normal’ bird feeding at codend (e.g. picking at fish heads poking out of codend).
 9. **At Bait** - Bird was feeding on the bait
 10. **Discard Feeding** - Bird was feeding on discarded fish or offal.
 11. **Foraging, Not Bait** - Bird was foraging/feeding near the vessel, but not feeding on the bait or discards.
 12. **Following** - Bird was following or resting near the vessel.
 13. **Harassment by Crew**- Bird was harassed by a crewman. Harassment includes throwing objects, or other nonlethal deterrent methods.
 14. **Killing by Crew** - Bird was intentionally or unintentionally killed by a crewman and is not gear related.
 15. **Maimed by Crew** - Bird was wounded by a crewman and is not gear related (e.g. bird is injured when gaffed by the rollerman).
 16. **Other** - Interaction is not included in the list of interaction codes.
 17. **Sighting of Banded/Tagged Bird** - Bird with a single or multiple bands/tags was observed on or near the vessel.
- that provides the most descriptive final outcome of the interaction.
1. **Hooked** - The bird was hooked and retrieved on the gear or was accidentally snagged by a loose hook. A bird does not have to be killed to be hooked.
 2. **Injuries** - The bird was injured during the event.
 3. **Flew Off** - The bird flew off or left the immediate area of the interaction.
 4. **Released To Water** - Any bird that was removed from the vessel or gear and returned to the water. This could be a bird that was involved in a bird storm.
 5. **Released Flew Off** - Any bird that was removed from the vessel or gear and released over board. Upon release, the bird flew off.
 6. **Died** - The bird did not live.
 7. **Carcass Salvaged** - The bird died and the whole specimen was saved.
 8. **Observer End Observing** - Use this code when observing a bird and the event ends because you return to other duties.
 9. **Not Applicable** -None of the above outcomes apply.

Interaction Outcome: Describes the interaction outcome. Choose the most accurate description of what happened to the bird(s) involved. In some instances, more than one option may apply to the event. If there is more than one outcome for an event, choose the option

Short-Tailed Albatross Counts: Short-Tailed Albatross must be identified to a specific age category. A specific count of the number of Short-Tailed Albatross in each category must be recorded. When completing the Bird Interaction, Activity, and Species paper form for Short-Tailed Albatross, do not fill out the Total Number of Birds field in the non-shaded area of the form. *See Figure 16-3: Example of Documentation for Short-Tailed Albatross Sighting and Specimen Collection on page 16-18.*

Identifying Characteristics: Record any identifying characteristics or other comments in this field.

Specimen?: If you collected any specimen from this species, indicate you did and enter the specimen information. *If you have specimens involving a Short-Tailed Albatross, you must also fill out the Bird Specimen and Tag Information paper form (if specimens are collected) in addition to entering and reporting the data in ATLAS.*

Completing Bird Specimen and Tag Information Form

The Bird Specimen and Tag Information Form in ATLAS must be filled out for any bird specimen collected. Each specimen requires a unique specimen number, even if taken from the same bird. For example, you collect a dead bird with a plastic tag. You must record 2 specimens on the Bird Specimen and Tag Information Form—the bird and the tag. Specimens from different events and different species may be listed on the same form. All specimens for a single event must be grouped together. See Figure 16-3: Example of Bird Specimen and Tag Information Form on page 16-19. Do not complete the paper form if you are assigned to an ATLAS vessel unless you are reporting a Short-Tailed Albatross specimen.

Cruise, Permit: Enter the cruise number supplied in your training or briefing. Vessel permits can be found on A-31.

Observer Name/Vessel Name: Enter your name and the name of the vessel.

Event Number: The event number for the specimen must correspond to the event number from which it was collected on the Bird Interaction, Activity and Species Form.

Species Code: Record the appropriate species code. The species code for each event must match the code on the Bird Interaction, Activity and Species Form. A complete list of Bird Species codes may be found in the Appendix on A-13.

Species Name: Record the bird name. The species name for each event must match the name used on the Bird Interaction, Activity and Species Form.

Specimen Number: Enter a unique number for each specimen collected. *Do not duplicate specimen numbers.* If there are multiple specimens collected from the same bird, each specimen must have a unique specimen number. Bird specimen numbers are independent from fish and marine mammal specimen numbers.

Enter the appropriate numeric code from the lists below in the corresponding boxes on the form (written descriptions are not needed).

Age of Bird: Only fill out this field if you are recording a Short-Tailed Albatross specimen. In ATLAS, you will see this field only if you entered the species code for Short-

Tailed Albatross. Choose the appropriate bird age and record the corresponding numeric code. Refer to your laminated guide to North Pacific Albatrosses for the identifying characteristic of each age category.

1. **Adult**
2. **Sub-Adult**
3. **Immature**
4. **Juvenile**

Specimen Type: Choose the best description for the type of specimen collected. Record the numeric code in the Specimen Type column. If there are multiple specimens with the same specimen type for the same species, each specimen should be recorded on a separate line.

1. **Pictures** - Any photograph taken of a bird (dead or alive)
2. **Feathers** - Any bird feather collected
3. **Beak** - The beak of the bird
4. **Tissue** - Any tissue sample collected
5. **Stomach** - The stomach of the bird and any stomach contents
6. **Bird Feet** - One or both of the feet. Record any tag information as a separate specimen
7. **Bird Head** - Only the head of the bird was saved. Collect the head of a Short-Tailed Albatross if you are unable to collect the whole bird
8. **Whole Bird** - The entire bird was collected
9. **Other** - Any other specimen or part of the bird not already listed
10. **Bird Tag Information** - Any information regarding a tag or band on a bird

“Tag Data” Tab: The bird tag data portion of the Bird Specimen Form should only be filled out for Specimen Type 10. Try to collect as much detailed information about each tag or band as possible. You do not have to have a tag or band number in order to record bird tag information. If a bird has multiple tags or bands record each tag or band as a separate specimen.

Tag Color: Choose the color of the band or tag:

1. **Red**
2. **Pink**
3. **Orange**
4. **Yellow**
5. **White**
6. **Blue**
7. **Green**
8. **Purple**
9. **Gray**
10. **Black**
11. **Gold**
12. **Silver**
13. **No Color** - Radio or Web Tag
14. **Other** - Any other color not listed above

Tag Type: Describes the type of tag or band:

1. **Plastic**
2. **Metal**
3. **Web Tag** - Small metal clip found between toe webbing
4. **Other** - Any other type of material not already listed above

Tag Location: This is a list of the possible tag or band locations on the bird:

1. **Right Leg**
2. **Left Leg**
3. **Right Wing**
4. **Left Wing**
5. **Right Foot** - web tag
6. **Left Foot** - web tag
7. **Neck**
8. **Beak**
9. **Other**

Tag Position: This is the position of the tag or band on the leg of the bird relative to the other tags:

- 1 - Only Tag
- 2 - Top Tag
- 3 - 2nd Tag
- 4 - 3rd Tag
- 5 - 4th Tag

Tag Number: Record the number on the tag or band exactly as it is displayed. If you do not have the tag in hand, but are able to see a tag on a live bird, record the number as accurately as possible.

Comments: Record any other pertinent information regarding the specimens in this field.

Short-Tailed Albatross Incidental Take Information

In the rare event an incidental take of a Short-Tailed Albatross occurs by your vessel, additional information is requested. To the best of your ability please answer the following questions on the back of the paper Bird Interaction, Activity, and Specimen Form. If you are on an ATLAS vessel you must also record your answers in the "Interaction, Description, and Comments" section of the form in ATLAS. Complete these questions only for Short-Tailed Albatross takes.

Gear and Vessel Operations Questions:

1. Was the gear set from the side or from the stern? Were floats attached to the longline?
2. Was the longline weighted and if so were weights integrated into the line or were weights added during the set (e.g., snap-on cannonball weights)?
3. What was the setting speed and direction relative to the wind?
4. If the set was at night was it clear or overcast? Could you see the moon and was it bright?
5. What kind of bait was the vessel using?
6. Was offal being discharged during the setting of the long line gear?
7. Were the streamer lines in good condition with individual streamers intact and not rolled up around the main line of the streamer lines? Did the streamer lines have sufficient drag to achieve maximum aerial extent behind the vessel (60 m aerial extent)? What was attached to the in-water end of each streamer line to create drag?
8. Were the streamer lines on either side of the longline/baited hooks?

Bycatch and Bird Questions:

1. What was the condition of carcass when it was retrieved?
2. How many other seabirds were caught in the set and

SEABIRD INTERACTIONS: RECORDING BIRD DATA

- what species? Were other birds taken throughout the trip (species and numbers)?
3. Did there seem to be more albatrosses than usual around the vessel in the few days before the take occurred? Were there more than usual around the vessel the day of the take?
 4. How many Short-Tailed Albatrosses were in the vicinity at the time of the set? If you do not know an exact number please provide an estimate.
 5. How many birds were in the area at the time and was their behavior unusual?
 6. Did the Short-Tailed Albatrosses or other birds seem to be more aggressive in attempting to steal bait?
 6. What were the natural light conditions at the time (bright, low/dim, twilight, dark)?
 7. If the event was at night, could you see the moon and was it bright?
 8. Describe the general weather over the past 24 hours.
 9. Were artificial lights on at the time of the collision? If yes, described what lights were on, the intensity, and the color.
 10. If red lighting was used, were those limited to interior spaces? Were windows to these interior spaces shaded?
 11. Were exterior lights shielded to direct illumination inboard and downward?

Spectacled Eider and Steller's Eider Incidental Take Information

In the rare event an incidental take of a spectacled or Steller's Eider occurs on your vessel, additional information is requested. Incidental takes of eiders are typically caused by collisions with rigging or the vessel itself. Although it is expected that most migrating eiders to respond to vessel presence by moving away from the vessel, two factors have been identified as potentially increasing the risk of collision with eiders in flight: 1) impaired visibility and 2) vessel lighting. It is especially important to note whether any red frequency lights were on such as the port running light or nighttime wheelhouse lights. To the best of your ability please answer the following questions. Record your answers in the "Interaction, Description, and Comments" section of the Bird Interaction, Activity, and Specimen Form in ATLAS. Complete these questions only for spectacled or Steller's Eider takes.

1. Did you observe the event, or did you find carcasses on the deck sometime after?
2. If you did not observe the event, what is your best estimate of when it occurred?
3. Where on the vessel did the strikes occur?
4. What were the total number of birds, and if you are able, the numbers of each sex?
5. Describe the cloud cover (e.g., clear, partly cloudy (percentage), overcast).

| Code | Knots | Air | Sea Description | Code | Knots | Air | Sea Description |
|------|-------|--------------|--|------|-------|---------------|--|
| 0 | 0 | Calm Air | Sea like a mirror | 7 | 28-33 | Near Gale | Sea heaps up and white foam from breaking waves begins to be blown in streaks in the direction of the wind. |
| 1 | 1-3 | Light Air | Ripples with the appearance of scales are formed, without foam crests. | 8 | 34-40 | Gale | Moderately high waves of greater length; the foam is blown in well-marked streaks along the direction of the wind. |
| 2 | 4-6 | Light Breeze | Small wavelets, still short, but more pronounced, crests have a glassy appearance but do not break. | 9 | 41-47 | Strong Gale | High waves; dense streaks of foam along the direction of the wind; crests of waves begin to topple, tumble, and roll over; spray may affect visibility. |
| 3 | 7-10 | Gentle Wind | Large wavelets; crests may break, scattered white caps. | 10 | 48-55 | Storm | Very high waves with long overhanging crests; the resulting foam is blown in dense white streaks along the direction of the wind; on the whole, the sea surface takes a white appearance; visibility affected. |
| 4 | 11-16 | Moderate | Small waves, becoming longer, fairly frequent white caps | 11 | 56-63 | Violent Storm | Exceptionally high waves, the sea is completely covered with long white patches of foam lying along the direction of the wind; all edges of the wave crests are blown into froth; visibility affected. |
| 5 | 17-21 | Fresh Wind | Moderate waves, taking a more pronounced long form; many white caps are formed (chance of some spray). | 12 | 64+ | Hurricane | The air is filled with foam and spray; sea completely white with driving sprays; visibility very seriously affected. |
| 6 | 22-27 | Strong Wind | Large waves begin to form; the white foam crests are more extensive everywhere (probably some spray) | 99 | | Unknown | Use this code if you do not know the sea state condition at the time of the event. |

Figure 16-2: Beaufort Sea State Descriptions

Bird Interaction, Activity and Species Form

| | | | |
|------------------------|-----------------------|---------------------|---|
| Cruise <u>25211</u> | Permit <u>1996</u> | Event # <u>1</u> | <input checked="" type="radio"/> Trip <input type="radio"/> Haul <input type="radio"/> Offload <small>(Circle One)</small> |
|------------------------|-----------------------|---------------------|---|

Observer Name Johnathan Livingston
 Vessel Name Ancient Mariner

Interaction Description

Date 07/17/2023 Time 1415

Bird Location 2

Fishery Location 3

Location During Trip or Offload

| Latitude (N) | | | E/W | Longitude | | |
|--------------|-----------|-----------|----------|-----------|-----------|-----------|
| Deg | Min | Sec | | Deg | Min | Sec |
| <u>57</u> | <u>12</u> | <u>06</u> | <u>W</u> | <u>68</u> | <u>32</u> | <u>14</u> |

Weather Conditions During Interaction

Beaufort Sea Scale 2 Weather 1

| Vessel Activity | Deterrent Type |
|--|--|
| Traveling <input checked="" type="radio"/> | Deterrent used? <u>1</u> |
| Setting <input type="radio"/> | Weights <input type="radio"/> |
| Offloading <input type="radio"/> | Other <input type="radio"/> |
| Sampling <input type="radio"/> | 1 Streamer Line <input checked="" type="radio"/> |
| Processing <input type="radio"/> | 1 Bird Bag <input type="radio"/> |
| Resting <input type="radio"/> | Lining Tube <input type="radio"/> |
| Fishing <input type="radio"/> | Discharge Offal <input type="radio"/> |
| Retrieving <input type="radio"/> | Unknown No. of Streamers. <input type="radio"/> |
| Not applicable <input type="radio"/> | 2 Bird Bags <input type="radio"/> |
| | Water Hose <input type="radio"/> |
| | 2 Streamer Lines <input type="radio"/> |

Interaction Description and Comments

1 adult Short-Tailed Albatross seen while traveling to fishing grounds. Noticed orange tag on left leg as bird flew off

| | |
|--|--|
| Species Code <u>850</u> | Species Name <u>short-Tailed Albatross</u> |
| Number of Birds <input type="text"/> | Count Type <u>1</u> |
| Good Look at Bird <input checked="" type="radio"/> Y <input type="radio"/> N <input type="radio"/> N/A | How Certain of ID <input checked="" type="radio"/> Y <input type="radio"/> N <input type="radio"/> M |
| Interaction Description <u>17</u> | Interaction Outcome <u>3</u> |

| | |
|--|--|
| Species Code | Species Name |
| Number of Birds <input type="text"/> | Count Type <input type="text"/> |
| Good Look at Bird <input type="text"/> | How Certain of ID <input type="text"/> |
| Interaction Description <input type="text"/> | Interaction Outcome <input type="text"/> |

Counts for Short-Tailed Albatross are recorded under specific age categories.

Short-Tailed Albatross Only

| | |
|--|---|
| Number of Adult Birds <u>1</u> | Number of Sub-Adults <input type="text"/> |
| Number of Immatures <input type="text"/> | Number of Juveniles <input type="text"/> |

Short Tailed-Albatross Only

| | |
|--|---|
| Number of Adult Birds <input type="text"/> | Number of Sub-Adults <input type="text"/> |
| Number of Immatures <input type="text"/> | Number of Juveniles <input type="text"/> |

Identifying Characteristics

White head with yellow wash. Bright pink, large bill

Specimen?

Identifying Characteristics

Banded Short-Tailed Albatross sighted in this event. Specimen data are recorded in the Bird Specimen and Tag Information Form.

Specimen?

| | |
|--|--|
| Species Code | Species Name |
| Number of Birds <input type="text"/> | Count Type <input type="text"/> |
| Good Look at Bird <input type="text"/> | How Certain of ID <input type="text"/> |
| Interaction Description <input type="text"/> | Interaction Outcome <input type="text"/> |

| | |
|--|--|
| Species Code | Species Name |
| Number of Birds <input type="text"/> | Count Type <input type="text"/> |
| Good Look at Bird <input type="text"/> | How Certain of ID <input type="text"/> |
| Interaction Description <input type="text"/> | Interaction Outcome <input type="text"/> |

Short Tailed-Albatross Only

| | |
|--|---|
| Number of Adult Birds <input type="text"/> | Number of Sub-Adults <input type="text"/> |
| Number of Immatures <input type="text"/> | Number of Juveniles <input type="text"/> |

Short Tailed-Albatross Only

| | |
|--|---|
| Number of Adult Birds <input type="text"/> | Number of Sub-Adults <input type="text"/> |
| Number of Immatures <input type="text"/> | Number of Juveniles <input type="text"/> |

Identifying Characteristics

Specimen?

Identifying Characteristics

Specimen?

Figure 16-3: Example of Documentation for a Banded Short-Tailed Albatross Sighting and Specimen Collection

DECK FORM

| | | | | |
|----------|--------|--------|----------|-------------|
| Date | Cruise | Permit | Haul No. | Offload No. |
| 07/21/23 | 1996 | 25211 | 73 | |

Page 11 of _____ for Vessel/Plant
 Page 3 of 3 for Haul/Offload

| Sample #: 3 | Sub-Sample #: | Sample Size: 3 | <input checked="" type="radio"/> Kgs Segments pots | # of Sampled Hooks: | |
|---------------------------------|-------------------------------------|---|--|-------------------------------------|---|
| Presorted <input type="radio"/> | Combined <input type="radio"/> | Unable to Follow Design <input type="radio"/> | No Fish in Sample <input type="radio"/> | | |
| Species | Sex | # | Weight | % ret. | Length, viability, injury, specimen, tally data, measurements, bird observations, sample design, notes: Pacific Cod = (61) D/O - L Pollock = (58) D/O - 1 Kam/Arrow - <input checked="" type="checkbox"/> L = (8) Bathyrāja - <input checked="" type="checkbox"/> <input checked="" type="checkbox"/> <input checked="" type="checkbox"/> L = (22) Bird Unid. - 1 = (1) saved carcass, 3 pics taken Flathead Sole - <input checked="" type="checkbox"/> = (4) |
| ----- KEYPUNCH ----- | <input checked="" type="checkbox"/> | 154 | 44.40 | <input checked="" type="checkbox"/> | |
| Pacific Cod | | 61 | 0 | 96 | |
| Pollock | | 5 | 4.28 | 93 | |
| Arrowtooth Fl. | | 3 | 2.95 | 0 | |
| Kamchatka Fl. | | 2 | 2.71 | 0 | |
| Kam/Arrow | | 3 | 0 | 0 | |
| Pollock | | 53 | 0 | 93 | |
| AK Skate | | 5 | 29.32 | 0 | |
| Bathyrāja U. | | 17 | 0 | 0 | |
| Northern Fulmar | | 1 | 1.93 | 0 | |
| Flathead Sole | | 4 | 3.21 | 0 | |

Documenting a seabird gear interaction: raw data should include detailed information about the event, physical traits, and weather conditions. Also indicate what specimens were collected.

| Sample #: | Sub-Sample #: | Sample Size: | <input type="radio"/> Kgs Segments pots | # of Sampled Hooks: | |
|---------------------------------|-------------------------------------|---|---|-------------------------------------|---|
| Presorted <input type="radio"/> | Combined <input type="radio"/> | Unable to Follow Design <input type="radio"/> | No Fish in Sample <input type="radio"/> | | |
| Species | Sex | # | Weight | % ret. | Length, viability, injury, specimen, tally data, measurements, bird observations, sample design, notes: - Dead Northern fulmar came up in gear during tally period. Body was pretty beat up. Hooked during setting. Dark plumage throughout, pale bill with large tubenose. - Moderate winds, ~ 12 knots small waves with white caps starting to form. Light rain |
| ----- KEYPUNCH ----- | <input checked="" type="checkbox"/> | | | <input checked="" type="checkbox"/> | |
| | | | | | |
| | | | | | |
| | | | | | |
| | | | | | |
| | | | | | |
| | | | | | |
| | | | | | |
| | | | | | |
| | | | | | |
| | | | | | |

Figure 16-5: Example of Bird Interaction Documentation on a Deck Form

STOMACH COLLECTION

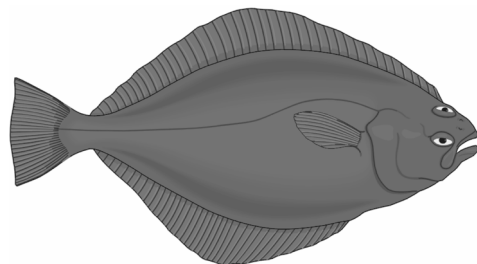

Table of Contents

| | |
|--|------|
| Who Collects Stomachs | 17-1 |
| Materials for Stomach Collections | 17-1 |
| Collection Procedures | 17-1 |
| Determining Sex and Spawning Condition | 17-2 |
| Stomach Collection Procedure | 17-2 |
| Selecting Fish for Your Specimens | 17-2 |
| Method of Extracting Stomachs | 17-3 |
| Entering Stomach Collection Data in the Length and Specimen Form | 17-4 |
| When Your Sea Time Is Finished | 17-4 |
| Debriefing Questionnaire | 17-4 |

INTRODUCTION

Stomach collections provide data on predation mortality of commercial stocks of fish and crab, and are used to estimate the degree of this mortality. Stomach data enhances our understanding of spatial, seasonal, and inter-annual patterns in the marine food web.

Your comments and suggestions about this duty are important to the Food Habits Lab. Complete the questionnaire at the end of this chapter to assist you in providing comments to the Food Habits Lab.

Food Habits Lab - Room 1093

Richard Hibpshman (206) 526-4238

richard.hibpshman@noaa.gov

KC Dill (206) 536-4238

Kathryn.dill@noaa.gov

Geoff Lang (206) 526-4196

geoff.lang@noaa.gov

Who Collects Stomachs?

Stomach collections are assigned in the BSAI to specific catcher processor vessels. Stomach collections are primarily assigned to vessels that have historically provided an adequate sampling platform. If you are assigned to one of these vessels, your inseason adviser will touch base with you to ensure you are able to get started. Stomach collections continue throughout

- Please read all instructions carefully.
- Raw data for the stomach collections are recorded on the Deck Form, and transferred directly to the Length and Specimen Form in ATLAS.
- Stop by the Food Habits Lab if you have questions prior to your deployment.

MATERIALS FOR STOMACH COLLECTIONS

- Stomach Contents Photo Form (see Figure 17-1)
- NMFS issued camera

Figure 17-1: Stomach Contents Photo Form

COLLECTION PROCEDURES

Determining Sex and Spawning Condition

To determine sex and spawning condition in flatfish and gadids, give the abdomen a light squeeze. The extrusion of milt (male) or eggs (female) indicates a fish in spawning condition. If no milt or eggs are released the fish is considered to be in a pre-spawning condition.

Stomach Collection Procedure

1. When you board a vessel that has been selected for the stomach collections, locate the Stomach Contents Photo Forms in your sampling gear.
2. Collect stomach specimens according to the length of fish (see “Selecting Fish for Your Specimens”).
3. Use the tally sheet on the back of the Stomach Contents Photo Form (see Figure 17-2 on page 17-3) to keep track of the length categories that you need to fill.

Fish must be selected from hauls sampled for species composition.

Collect fish that do not show regurgitation. These signs include prey items (fresh or digested) in mouth or gill rakers or flaccid (loose and bloated) stomachs. Do not keep these!



4. Signs of “natural” stomachs include stomachs that are constricted tightly around the prey inside and naturally empty stomachs, which appear tight and contracted. **Keep these!** Determine the weight, sex, fork length, and spawning condition of each fish and collect the stomach without losing any consumed prey.

Record the raw data on your Deck Form. Assign a specimen number to each record and indicate which sample the specimen came from. Clearly document all specimen types associated with each fish selected for stomach data collection. See Figure 17-7 on page 17-8 and Figure 17-8 on page 17-9 for raw data documentation examples).



If a fish is discarded due to regurgitation, take the next fish in the basket. If the subsequent fish has food in its stomach, go ahead and collect the specimen. If the subsequent fish has an empty stomach (naturally empty or regurgitated) discard it and go onto the next fish until a non-empty stomach is encountered. This special note applies only to the fish selected immediately after a regurgitation discard, because we don't want you to replace a regurgitated stomach with an empty stomach. A naturally empty stomach is a valid collection when not collected to replace a regurgitated stomach.

5. Weigh the fish and determine the spawning condition. Record these data on the Deck Form.
6. Record Cruise, Permit Haul No. and Specimen No. on the Stomach Contents Photo Form.
7. Place the Stomach Contents Form on the MCP scale and tare the scale. Do not remove the form from the platform scale.
8. Remove the stomach from the specimen as described on “Method of Extracting Stomachs” on page 17-3.
9. Make an incision the length of the stomach.
10. Remove all stomach contents (prey items) and place them on the Stomach Content Photo Form. Spread the contents out as needed into a single layer of prey so that no prey items are obscuring others (see examples on page 17-7).
11. Record the weight of the stomach contents.
12. Take the first photo making sure the entire Stomach Content Photo Form is in the image frame.
13. Any time there are fish or crab prey, and as time allows when there are no fish or crab prey, flip the prey over and take a second image. This will facilitate species and sex ID for prey items. Document the number of pictures you took.

Stop collecting when you have filled the Stomach Collection Tally sheet for the designated predator species.

Selecting Fish for Your Specimens

Stomach specimens should only be collected from fish which were randomly selected for your species

composition samples. Once you have your randomly selected fish for your composition sample, you should collect stomachs based on the defined size strata. *At no time should you collect fish from outside of your composition sample for stomach collections.* Select fish according to the following guidelines:

- Stratify the stomach collection by size of fish. No more than 5 stomach specimens should be collected per sampled haul, and only collect stomachs from one predator species per sampled haul. It is acceptable to collect from multiple hauls each day.
- Use the Stomach Collection Data Tally Sheet on the back of the Stomach Contents Photo Form (see Figure 17-2) for the selected species, to keep track of specimens collected per size category.

| Stomach Collection Tally Sheet | |
|--------------------------------|-----------|
| Species Name: _____ | |
| Size 1: _____ CM | 20 |
| Size 2: _____ CM | 20 |
| Size 3: _____ CM | 20 |
| Size 4: _____ CM | 20 |
| Total: | 80 |

Reminder: Try to collect one block of 5 stomach specimens at each haul that is sampled for stomachs.

Figure 17-2: Stomach Collection Data Tally Sheet

- There are four length categories. Refer to the following chart to determine the size category break down for the species from which you are collecting specimens. Fill in the blanks on your tally sheet according to the appropriate size category.

Pacific Cod and Arrowtooth Flounder size categories:

<31 cm 51-70 cm
 31-50 cm >70 cm

Walleye Pollock size categories:

<30 cm 40-50 cm
 30-39 cm >50 cm

- Depending on the catch composition, you may have

difficulty finding specimens of a particular species or size strata (especially if your vessel targets flatfish or large fish). If this happens, take more from the size categories you are finding (but no more than 5 per haul) or wait a few hauls if you think your vessel may catch a different size group. It is acceptable to take fewer than 5 stomach specimens from species or sizes that are hard to find (e.g., smaller cod).

- If the stomach samples are being collected from a species that you expect will often be predominant in the catch, collect 5 stomach specimens per haul, all from a single size category. In this situation, the stomach collection could involve 16 hauls total – 4 different hauls per each of the 4 size categories with 5 stomachs collected per haul until the desired numbers are collected. Depending on the catch composition, it may take several weeks to fill all of the size categories.

Method of Extracting Stomachs

1. To examine a stomach for regurgitation, first examine the mouth and gill rakers. If there is no sign of regurgitation, keep the fish and continue with the collection process. If there are signs of regurgitation select a different fish. *Be aware that Arrowtooth are prone to regurgitation.*
2. Measure, weigh, and determine the sex of the fish for the sex/length/weight specimen paying close attention to not damage the stomach.
3. Cut through the skin of the fish as shown in Figure 17-3: Removing a Gadid Stomach on page 17-5 and in Figure 17-4: Removing a Flatfish Stomach on page 17-6. Be careful not to cut into the stomach. Open the body cavity at the incision and examine the stomach for any damage. *Color plates of Figure 17-3 and 17-4 can be found in your Species Identification Guide.*
4. Excise the stomach by cutting just anterior to the pyloric caeca and posterior to the gill chamber. Include all of the esophagus.
5. Proceed with the photo collection process (see Stomach Collection Procedure on “Stomach Collection Procedure” on page 17-2).

Entering Stomach Collection Data in the Length and Specimen Form

Stomach collection data recorded on the deck form are transferred to the Length and Specimen Data Form in ATLAS. See “Completing the Length and Specimen Form” on page 13-16 for instructions regarding sex/length entries, specimen entries and specimen number protocols. Length and Specimen Form instructions specific to the stomach data collection are listed below.

- **Sample design:** Stomach collections will come from within your composition sample and will have the design code associated with how the fish were selected from the population within the composition sample. If all fish encountered in the sample are selected, use code 10, census. If a fish is selected only because of its size, use code 4, size selected.
- **Specimen Number:** The specimen number for the stomach collection and the associated specimen types (photo, stomach contents, maturity scan and sex/length/weight) must be the same. Follow specimen numbering protocol described at “Specimen Number” on page 13-17.
- **Specimen Type:** There are four specimen types associated with each stomach collection:

3- Sex/Length/Weight

7- Maturity Scan: only two Maturity Scan codes are used with stomach collection data

3-Pre-Spawn

4- Spawning

14- Stomach Contents: this is the primary specimen type. Once this is selected, you will have three options to choose from:

Stomach empty: select this when you find a naturally empty stomach. This is still a legitimate collection but there are no contents to weigh or to photograph.

Contents too light to weigh: select this when there are prey in the stomach but they are too light to register on the MCP scale. Stomach contents weight is not recorded for this specimen but a photo is still required.

Contents present and weighed: select this option to record the weight of the stomach contents as displayed on the MCP.

15- Photo: indicates that photos of the stomach contents on the Stomach Contents Photo Form were taken. When

selecting Photo specimen type, you must also select Stomach Contents. *A photo is not required for naturally empty stomachs.*

When Your Sea Time Is Finished

- Inform your inseason adviser about the status of the stomach collection.
- Complete the debriefing questionnaire.

DEBRIEFING QUESTIONNAIRE

During debriefing, please give your debriefer your debriefing questionnaire (your answers may be recorded in your daily notes and then photocopied).

Your Name:

Vessel Name:

1. Did you have any problems in carrying out the stomach collection (lack of sufficient equipment, lack of time, etc.)?
2. How long did it take you to collect your specimens from one haul?
3. Was it difficult to collect the expected number of specimens from different size groups?
4. Do you have any suggestions that would improve the sampling procedure?
5. Do you have any suggestions that would make it easier for you to successfully complete this duty?

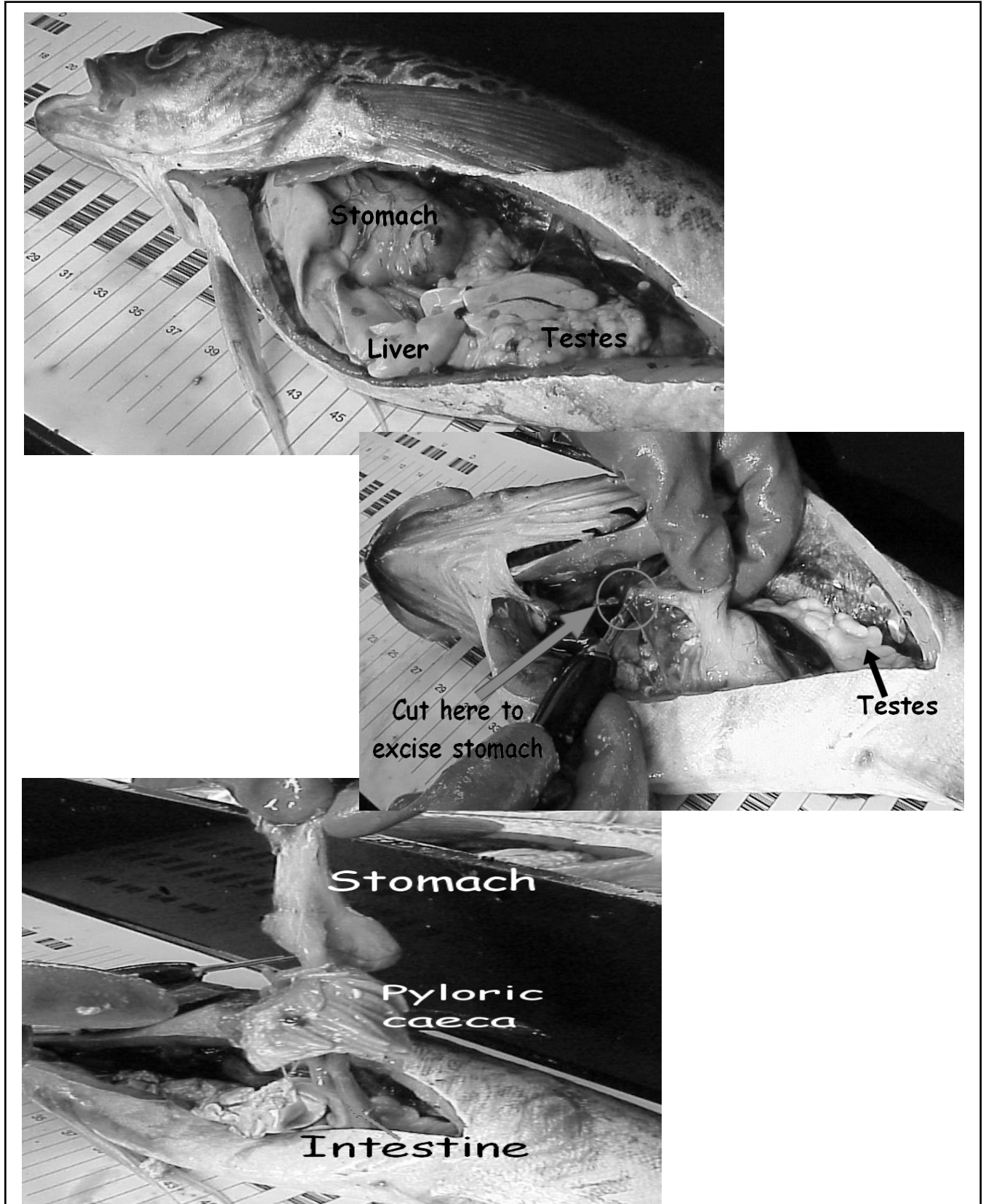

Figure 17-3: Removing a Gadid Stomach (Color photos located in your Species ID Manual)

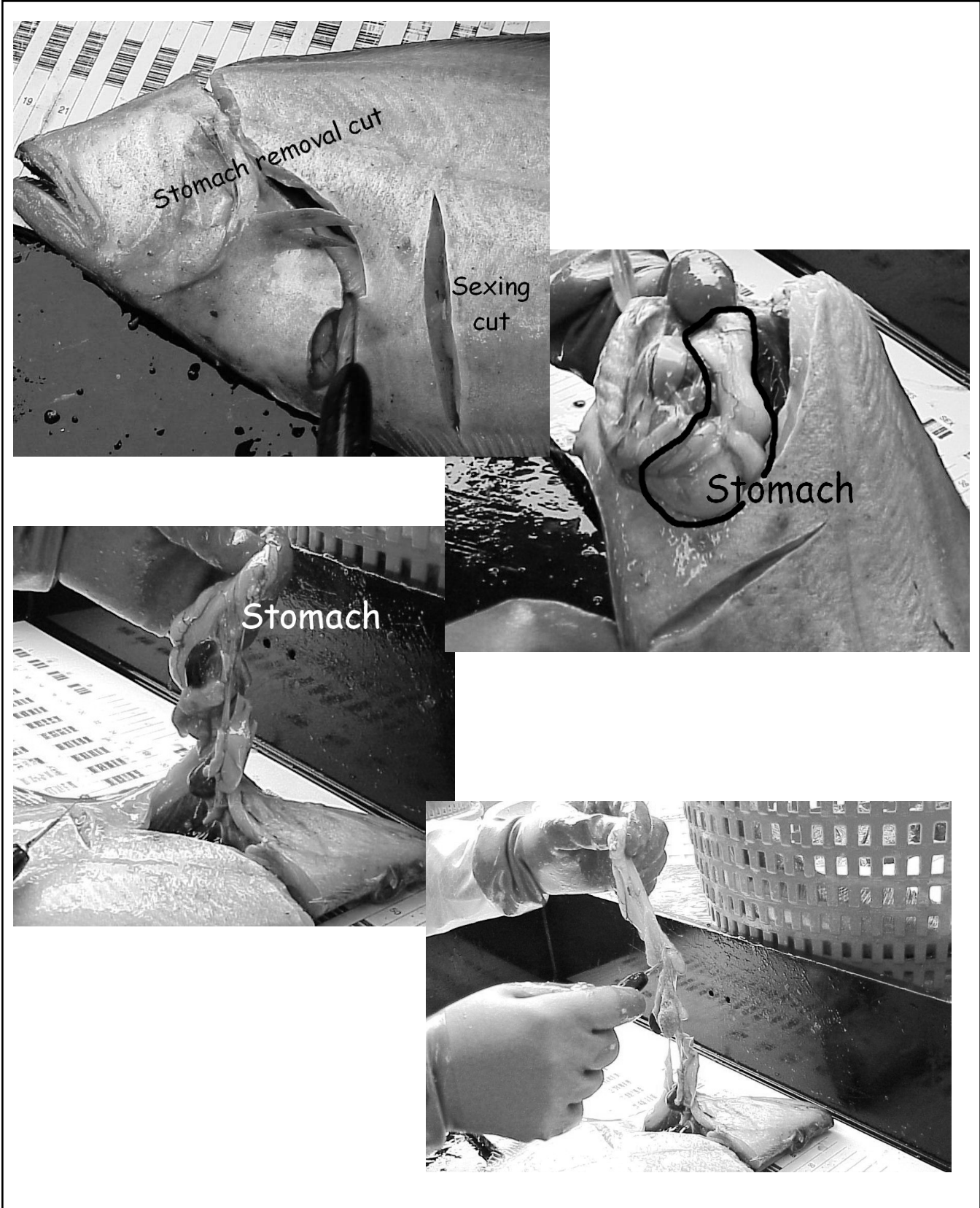

Figure 17-4: Removing a Flatfish Stomach (Color photos located in your Species ID Manual)



Figure 17-5: Pollock Stomach Contents on Stomach Contents Photo Form



Figure 17-6: Arrowtooth Flounder Stomach Contents on Stomach Content Photo Form

STOMACH COLLECTION: DEBRIEFING QUESTIONNAIRE

DECK FORM

| | | | | | |
|----------------|--------------|------------|-----------|-------------|--|
| Date | Cruise | Permit | Haul No. | Offload No. | Page <u>141</u> of _____ for Vessel/Plant |
| <u>2/23/23</u> | <u>28675</u> | <u>309</u> | <u>47</u> | | Page <u>2</u> of <u>3</u> for Haul/Offload |

| | | | |
|---------------------------------|--------------------------------|---|---|
| Sample #: <u>2</u> | Sub-Sample #: | Sample Size: <u>10535.00</u> <small>Kgs Segments pots</small> | # of Sampled Hooks: |
| Presorted <input type="radio"/> | Combined <input type="radio"/> | Unable to Follow Design <input type="radio"/> | No Fish in Sample <input type="radio"/> |

| Species | Sex | # | Weight | % ret. | Length, viability, injury, specimen, tally data, measurements, bird observations, sample design, notes: |
|----------------------|-------------------------------------|------------|-----------------|-------------------------------------|---|
| ----- KEYPUNCH ----- | <input checked="" type="checkbox"/> | <u>172</u> | <u>10535.00</u> | <input checked="" type="checkbox"/> | <p>Start: <u>31007</u> End: <u>41452</u></p> <p>Total Sample Wt: <u>10535.00</u> Bycatch wt: <u>-74.02</u> Pollock Subset: <u>-79.58</u> weight of: <u>10381.40</u> uncounted pollock</p> <p>Flowscale/MCP start: <u>33243</u> End: <u>33324</u></p> <p style="text-align: right;">T.S.</p> |
| Pollock | | <u>0</u> | <u>10381.40</u> | <u>100</u> | |
| Pollock | | <u>52</u> | <u>37.98</u> | <u>100</u> | |
| Pollock | | <u>57</u> | <u>41.30</u> | <u>100</u> | |
| Flathead Sole | | <u>32</u> | <u>11.66</u> | <u>100</u> | |
| P. Cod | | <u>6</u> | <u>45.08</u> | <u>100</u> | |
| Alaska Skate | | <u>1</u> | <u>7.82</u> | <u>100</u> | |
| Rex Sole | | <u>1</u> | <u>1.74</u> | <u>100</u> | |
| Arrowtooth FL. | | <u>7</u> | <u>2.60</u> | <u>100</u> | |
| Jellyfish | | <u>15</u> | <u>5.12</u> | <u>0</u> | |
| Northern R. Sole | | <u>1</u> | <u>.30</u> | <u>100</u> | |
| | | | | | |
| | | | | | |

| | | | |
|---------------------------------|--------------------------------|---|---|
| Sample #: | Sub-Sample #: | Sample Size: | # of Sampled Hooks: |
| Presorted <input type="radio"/> | Combined <input type="radio"/> | Unable to Follow Design <input type="radio"/> | No Fish in Sample <input type="radio"/> |

| Species | Sex | # | Weight | % ret. | Length, viability, injury, specimen, tally data, measurements, bird observations, sample design, notes: | | | | | | | | | | | | | | | | | | | | |
|----------------------|-------------------------------------|---|--------|-------------------------------------|---|----------|----------|-------------|-------------|-------------|-------------|-------------|-------------|-------------|-------------|-------------|-------------|-------------|-------------|-------------|-------------|-------------|-------------|--|-------------|
| ----- KEYPUNCH ----- | <input checked="" type="checkbox"/> | | | <input checked="" type="checkbox"/> | <p><u>Pollock S/L</u></p> <table style="margin-left: 20px;"> <tr><td><u>M</u></td><td><u>F</u></td></tr> <tr><td><u>29-1</u></td><td><u>43-L</u></td></tr> <tr><td><u>42-1</u></td><td><u>46-L</u></td></tr> <tr><td><u>43-L</u></td><td><u>47-1</u></td></tr> <tr><td><u>46-1</u></td><td><u>48-L</u></td></tr> <tr><td><u>47-1</u></td><td><u>49-1</u></td></tr> <tr><td><u>48-1</u></td><td><u>50-1</u></td></tr> <tr><td><u>49-1</u></td><td><u>51-1</u></td></tr> <tr><td><u>52-1</u></td><td><u>52-1</u></td></tr> <tr><td></td><td><u>54-1</u></td></tr> </table> <p><u>Pollock Stomachs (sample 2)</u></p> <p>sp# <u>200-M/46/.62</u> / spawn stomach contents = <u>.05</u> 1 photo</p> <p>sp# <u>201-F/47/.63</u> / spawn stomach contents = <u>.03</u> 1 photo</p> <p>sp# <u>202-M/47/.64</u> / spawn empty stomach</p> <p>sp# <u>203-M/49/.69</u> / spawn stomach contents = <u>.09</u> 2 photos</p> <p>sp# <u>204-F/49/.75</u> / spawn stomach contents = <u>.10</u> 2 photos</p> | <u>M</u> | <u>F</u> | <u>29-1</u> | <u>43-L</u> | <u>42-1</u> | <u>46-L</u> | <u>43-L</u> | <u>47-1</u> | <u>46-1</u> | <u>48-L</u> | <u>47-1</u> | <u>49-1</u> | <u>48-1</u> | <u>50-1</u> | <u>49-1</u> | <u>51-1</u> | <u>52-1</u> | <u>52-1</u> | | <u>54-1</u> |
| <u>M</u> | <u>F</u> | | | | | | | | | | | | | | | | | | | | | | | | |
| <u>29-1</u> | <u>43-L</u> | | | | | | | | | | | | | | | | | | | | | | | | |
| <u>42-1</u> | <u>46-L</u> | | | | | | | | | | | | | | | | | | | | | | | | |
| <u>43-L</u> | <u>47-1</u> | | | | | | | | | | | | | | | | | | | | | | | | |
| <u>46-1</u> | <u>48-L</u> | | | | | | | | | | | | | | | | | | | | | | | | |
| <u>47-1</u> | <u>49-1</u> | | | | | | | | | | | | | | | | | | | | | | | | |
| <u>48-1</u> | <u>50-1</u> | | | | | | | | | | | | | | | | | | | | | | | | |
| <u>49-1</u> | <u>51-1</u> | | | | | | | | | | | | | | | | | | | | | | | | |
| <u>52-1</u> | <u>52-1</u> | | | | | | | | | | | | | | | | | | | | | | | | |
| | <u>54-1</u> | | | | | | | | | | | | | | | | | | | | | | | | |
| | | | | | | | | | | | | | | | | | | | | | | | | | |
| | | | | | | | | | | | | | | | | | | | | | | | | | |
| | | | | | | | | | | | | | | | | | | | | | | | | | |
| | | | | | | | | | | | | | | | | | | | | | | | | | |
| | | | | | | | | | | | | | | | | | | | | | | | | | |
| | | | | | | | | | | | | | | | | | | | | | | | | | |
| | | | | | | | | | | | | | | | | | | | | | | | | | |
| | | | | | | | | | | | | | | | | | | | | | | | | | |
| | | | | | | | | | | | | | | | | | | | | | | | | | |
| | | | | | | | | | | | | | | | | | | | | | | | | | |
| | | | | | | | | | | | | | | | | | | | | | | | | | |

Figure 17-7: Example of Raw Data Documentation for Pollock Stomach Data Collection

DECK FORM

| | | | | | |
|----------|--------|--------|----------|-------------|--|
| Date | Cruise | Permit | Haul No. | Offload No. | Page <u>73</u> of _____ for Vessel/Plant |
| 05/30/23 | 24100 | 1920 | 141 | | Page <u>3</u> of <u>3</u> for Haul/Offload |

| | | | | |
|---------------------------------|--------------------------------|---|--|---|
| Sample #: <u>3</u> | Sub-Sample #: | Sample Size: <u>181.37</u> | <small>Kgs Segments pots</small> | # of Sampled Hooks: |
| Presorted <input type="radio"/> | Combined <input type="radio"/> | Unable to Follow Design <input type="radio"/> | | No Fish in Sample <input type="radio"/> |

| Species | Sex | # | Weight | % ret. | Length, viability, injury, specimen, tally data, measurements, bird observations, sample design, notes: | | | | | | | | | | | | | | | | | | | | | | |
|----------------------|--------|-----|--------|--------|--|---|---|------|------|------|------|------|------|------|------|------|------|--|------|---|---|--------|--------|--|--------|--|--------|
| ----- KEYPUNCH ----- | X | 248 | 181.37 | X | <p><u>Flowscale/MCP</u> Start: 37169 End: 37348</p> <p><u>Flathead S/L</u></p> <table style="margin-left: 20px;"> <tr><td>M</td><td>F</td></tr> <tr><td>16-1</td><td>17-1</td></tr> <tr><td>18-1</td><td>19-L</td></tr> <tr><td>25-L</td><td>22-L</td></tr> <tr><td>27-L</td><td>24-L</td></tr> <tr><td>29-L</td><td>25-1</td></tr> <tr><td></td><td>26-1</td></tr> </table> <p><u>Arrowtooth S/L</u></p> <table style="margin-left: 20px;"> <tr><td>M</td><td>F</td></tr> <tr><td>(54)-1</td><td>(50)-1</td></tr> <tr><td></td><td>(51)-1</td></tr> <tr><td></td><td>(52)-1</td></tr> </table> <p style="text-align: right;">P.F.</p> | M | F | 16-1 | 17-1 | 18-1 | 19-L | 25-L | 22-L | 27-L | 24-L | 29-L | 25-1 | | 26-1 | M | F | (54)-1 | (50)-1 | | (51)-1 | | (52)-1 |
| M | F | | | | | | | | | | | | | | | | | | | | | | | | | | |
| 16-1 | 17-1 | | | | | | | | | | | | | | | | | | | | | | | | | | |
| 18-1 | 19-L | | | | | | | | | | | | | | | | | | | | | | | | | | |
| 25-L | 22-L | | | | | | | | | | | | | | | | | | | | | | | | | | |
| 27-L | 24-L | | | | | | | | | | | | | | | | | | | | | | | | | | |
| 29-L | 25-1 | | | | | | | | | | | | | | | | | | | | | | | | | | |
| | 26-1 | | | | | | | | | | | | | | | | | | | | | | | | | | |
| M | F | | | | | | | | | | | | | | | | | | | | | | | | | | |
| (54)-1 | (50)-1 | | | | | | | | | | | | | | | | | | | | | | | | | | |
| | (51)-1 | | | | | | | | | | | | | | | | | | | | | | | | | | |
| | (52)-1 | | | | | | | | | | | | | | | | | | | | | | | | | | |
| Flathead Sole | | 63 | 36.66 | 100 | | | | | | | | | | | | | | | | | | | | | | | |
| Flathead Sole | | 68 | 33.24 | 100 | | | | | | | | | | | | | | | | | | | | | | | |
| Flathead Sole | | 52 | 28.34 | 100 | | | | | | | | | | | | | | | | | | | | | | | |
| Arrowtooth FL. | | 28 | 38.22 | 100 | | | | | | | | | | | | | | | | | | | | | | | |
| Pollock | | 14 | 27.33 | 100 | | | | | | | | | | | | | | | | | | | | | | | |
| N. Rock Sole | | 17 | 5.78 | 100 | | | | | | | | | | | | | | | | | | | | | | | |
| Halibut | | 2 | 2.71 | 0 | | | | | | | | | | | | | | | | | | | | | | | |
| Bignooth Sculpin | | 1 | 3.70 | 0 | | | | | | | | | | | | | | | | | | | | | | | |
| Alaska Plaice | | 1 | 1.17 | 100 | | | | | | | | | | | | | | | | | | | | | | | |
| Plain Sculpin | | 1 | 1.00 | 0 | | | | | | | | | | | | | | | | | | | | | | | |
| P. Cod | | 1 | 3.22 | 100 | | | | | | | | | | | | | | | | | | | | | | | |

| | | | | |
|---------------------------------|--------------------------------|---|--|---|
| Sample #: | Sub-Sample #: | Sample Size: | <small>Kgs Segments pots</small> | # of Sampled Hooks: |
| Presorted <input type="radio"/> | Combined <input type="radio"/> | Unable to Follow Design <input type="radio"/> | | No Fish in Sample <input type="radio"/> |

| Species | Sex | # | Weight | % ret. | Length, viability, injury, specimen, tally data, measurements, bird observations, sample design, notes: |
|----------------------|-----|---|--------|--------|--|
| ----- KEYPUNCH ----- | X | | | X | <p><u>Arrowtooth Stomachs (sample 3)</u></p> <p>sp# 121-F/51/1.44/pre-spawn stomach contents = .07 1 photo</p> <p>sp# 122-F/52/1.50/pre-spawn stomach contents = .26 2 photos</p> <p>sp# 123-M/54/1.68/pre-spawn stomach contents = .33 1 photo</p> <p>sp# 124-F/50/1.40/pre-spawn stomach contents too light to register on scale 1 photo</p> |
| | | | | | |
| | | | | | |
| | | | | | |
| | | | | | |
| | | | | | |
| | | | | | |
| | | | | | |
| | | | | | |
| | | | | | |
| | | | | | |
| | | | | | |

National Marine Fisheries Service/Fisheries Monitoring and Analysis Division Ver. 2010

Figure 17-8: Example of Raw Data Documentation for Arrowtooth Stomach Data Collection

This page intentionally left blank.

ATLAS INSTRUCTIONS

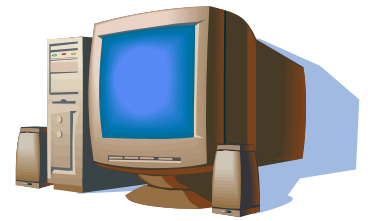

Table of Contents

| | |
|---|-------|
| Starting the Atlas Software | 18-2 |
| ATLAS Login Screen | 18-2 |
| New Users | 18-2 |
| Required Data Entry Fields | 18-5 |
| Data Entry | 18-6 |
| Trip Data Form | 18-6 |
| Hook Count Data Form | 18-7 |
| Haul Data Form | 18-7 |
| Offload Data Form | 18-9 |
| Non-Fishing or Non-Delivery Day Form | 18-10 |
| Flow Scale– MCP Scale Weight Comparison Data Form | 18-11 |
| Species Composition Data Form | 18-11 |
| Length Data Form | 18-15 |
| Specimen Data Form | 18-16 |
| Finding Specific Length Specimen Records | 18-17 |
| Salmon Data Form | 18-18 |
| Marine Mammal Data Form | 18-18 |
| Bird Data Form | 18-20 |
| Fish/Crab/Invert. Tracking Form | 18-22 |
| Halibut Deck Sort Form | 18-22 |
| Pot Opening Data Form | 18-24 |
| Electronic Scale Test Log | 18-24 |
| Observer Images Form | 18-24 |
| Inseason Messages | 18-24 |
| Pickup Messages Button | 18-26 |
| Broadcast Messages | 18-26 |
| Transmitting Data | 18-26 |
| Entering and Transmitting Data Using an USB Flash Drive | 18-28 |
| Backup/Archive | 18-29 |
| Export Data for Vessel | 18-29 |
| Reports | 18-30 |
| ATLAS FAQ's and Basic Troubleshooting | 18-30 |

INTRODUCTION

The ATLAS software is an electronic input program that allows groundfish and halibut observers to enter and send data directly from a vessel or plant to NMFS at the Alaska Fisheries Science Center in Seattle. Once the electronic observer data is received, the data are used by NMFS fisheries managers to make inseason management decisions on those ongoing fisheries.

Data are also reviewed weekly by Observer Program staff (Inseason Advisors) to help ensure that data are of the highest quality. The software also allows observers and Observer Program staff to communicate via inseason messages. Inseason communication serves as a vital link by helping observers in the field, with any issues they

may face, both with observer related duties and technical issues. In the event you ever have technical issues with the ATLAS Software, please contact NMFS staff (see “Contact Addresses and Numbers” on page A-61).

This manual will provide a basic understanding of the features provided with the ATLAS software and how to use those features. This manual assumes that the reader already has some rudimentary understanding of the Windows operating system. Please inform an instructor if you need more computer training prior to departing for your assignment. A tutorial will be given during your regular observer training/briefing. For the rest of these instructions, the word “ATLAS” will be used for term “ATLAS software.”

STARTING THE ATLAS SOFTWARE

If you are a full coverage observer, assigned to a vessel or plant that has a computer equipped with ATLAS, you will first need to locate that computer. If you are a partial coverage observer, your contractor will supply you a laptop for use while in the field. It is your responsibility to safeguard the equipment assigned to you. This includes keeping liquids away from the computer/laptop at all times and storing your laptop in a secure place on the vessel when not in use.

After locating the computer with ATLAS, go to the Windows desktop and double click on the icon labeled Observer ATLAS. When the Atlas program starts, the program will start inside a web browser. The browser does not have to be connected to the internet as the Atlas software that is inside the browser will run while the computer is offline. *Anytime you have ATLAS open, you should remain with the computer and when you are done with data entry and data transmission you should logout of ATLAS.*

ATLAS Login Screen

Once ATLAS starts, the first screen you will see is the ATLAS Login screen.

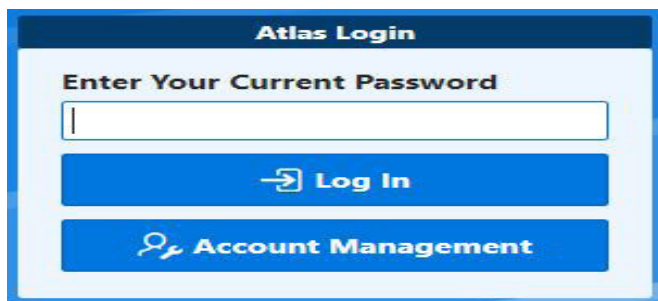

Figure 18-1: ATLAS Login Screen

Account Management - Adding New Users

To create new users click on the Account Management button (Figure 18-1). If you are the sole observer on a vessel or at a plant and have not entered any data or inseason messages for that vessel/plant during the current deployment, you will need to click on the Account Management button (Figure 18-1). Then click on the Create Observer button (Figure 18-2). Enter your cruise, first name, last name and the password for your data. Once this data has been entered then click on the Submit button (Figure 18-3). Passwords are case

sensitive and must be at least 4 characters/numbers long. *Important note, if a lead observer archives the data then all Atlas user accounts will be deleted as well and will have to be re-created if needed.*

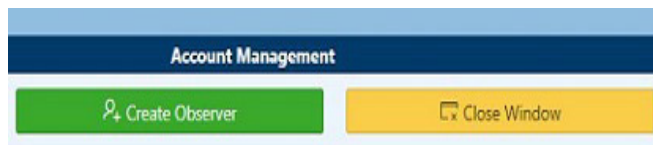

Figure 18-2: Account Management Screen

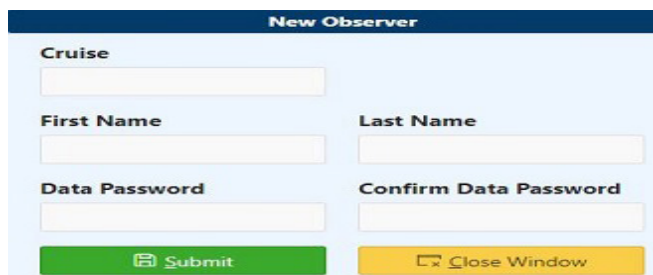
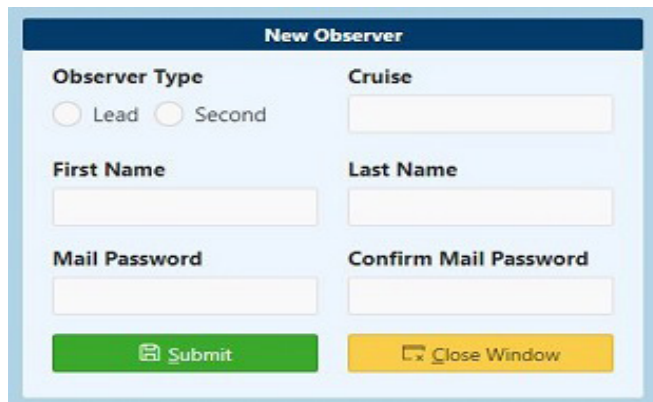

Figure 18-3: Submit Button

If there are multiple observers assigned to the vessel or plant at the same time, each observer will need to create and Atlas account for inseason messaging. Click on the Account Management button (Figure 18-1). Then click on the Create Observer button (Figure 18-2). Select if the account is for a lead or second observer, enter your cruise, first name, last name, and inseason mail password (Figure 18-4). If the account is for a lead observer you will also need to create a data password. All Atlas data is entered under the leads cruise number. If the account is for a second observer you only need to create a mail password that you will use for inseason messages inside of Atlas.



18-4: Entering Mail Password Screen

You must identify a unique ATLAS data password for each contract/cruise. The password cannot be reused in subsequent contracts. If you are in the Partial Coverage sector and were given the same laptop you had on a previous cruise, you must choose a different data password than you used on the previous cruise. If you login to ATLAS with the same data password from a previous cruise, ATLAS will default to your previous cruise, and you will not be able to enter any data from your new cruise. Contact NMFS IT staff if you encounter difficulties with this (see page A-61).

Once you have created a new data or inseason message password, you will need to re type it again for security purposes. Once the data and or inseason message password has been re-typed select the Submit button to continue. Then type in the data password just created and select the Log In button to enter ATLAS. Please remember that if you are the lead observer and another observer will also be entering data under your cruise number, you will need to provide the second observer with the data password.

If you receive an error message that the re-typed password does not match the new password, you will need to re-enter both fields again.

It is extremely important that you do not share your passwords with any vessel or plant personnel. If someone besides the second observer gains access to your password, they then have the ability to make changes to your data without your knowledge.

Account Management - Editing Users

To make changes to Atlas users, click on the Account Management button (Figure 18-1). In the list of users select the button of what you want to change. You can make changes to your name, password, or you can change a second observer to a lead observer (Figure 18-5). *In order to change your passwords, you must know your current passwords. If you do not know your current password, you will need to contact the Observer Program to gain access to all the data that has been entered so far.*



Figure 18-5: Editing Users Screen

Account Management - Remove Users

When the changing of assignments of observers takes place on the vessel or plant, it is critical that those observers who are leaving the vessel, have their accounts removed. To remove an account click on the Account Management button (Figure 18-1). Find the correct row in the list and select the remove button (Figure 18-5). Then in the confirm remove screen click on Remove Observer. If a lead observer archives, all Atlas user accounts will automatically be removed.

Account Management - Changing Second Observers to Lead Observers

When a current second observer moves to a lead observer on the vessel or plant, the second observer needs to move their Atlas account to a lead account. To move an account from second to lead click on the Account Management button (Figure 18-1). Find the correct row in the list and select the Become lead button (Figure 18-5). Then enter the data password that the data will now be entered under. If the previous lead observer archives, all Atlas user accounts will automatically be removed.

Current Users

If you are logging into ATLAS to continue data entry, enter your current data password then select the Log In button to enter the Atlas software (Figure 18-1).

ATLAS Main Menu

Once you have successfully entered your password, the ATLAS Main Menu (Figure 18-6) will appear. The ATLAS Main Menu is the starting point for the rest of ATLAS.

In the *full coverage sector*, the vessel permit and vessel name field will already be filled out and you won't need to make changes to these fields.

In the *partial coverage sector*, after creating your new user and you have logged into Atlas, select the button Select Assignment. A pop-up box will appear with a list of vessels. Select the vessel that you will be entering data for. Many vessels have the same name, so be sure to verify the length and ADF&G number next to the vessel name! This will ensure you have selected the correct vessel. If you enter your data under the wrong permit number you will receive an inseason message that you need to re-enter all your data under the correct permit. When you are assigned to a different vessel log into ATLAS using your current password and then click on the Update Assignment button. A pop-up box will appear with a list of vessels. Select the vessel that you will be entering data for. ATLAS will only reference data for one vessel at a time. Once you have entered data for multiple vessels you can switch between the data for each vessel simply by selecting the Update Assignment button from the ATLAS Main Menu and selecting the desired vessel from the list.

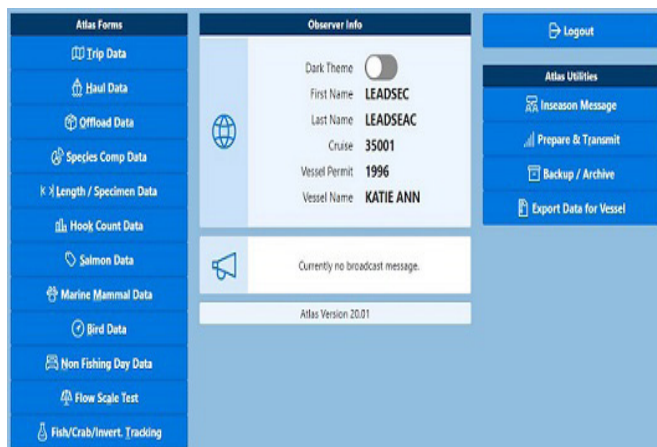

Figure 18-6: ATLAS Main Menu

Navigation Buttons

On the left side of the ATLAS Main Menu, you will find the ATLAS navigation buttons that will allow you to access the observer electronic forms. If you are stationed on a vessel, all data entry must start with the Trip Data Form (except for Non-Fishing Days and Hook Counts). If you are stationed at a plant, all data entry must start with the Offload Data form, or the Non-Fishing Days.

On the right side of the Atlas Main Menu you will find the Navigation buttons to the Atlas Utilities.

| Navigation Title | Navigation Function |
|---------------------------|---|
| Trip Data | Opens Trip Data form for vessel observers. |
| Haul Data | Opens Haul Data form for Vessel Observers. |
| Pot Opening Data | Opens Pot Opening form for vessel observers. This button will only appear for vessels that fish with pot gear. |
| Electronic Scale Test Log | Opens Electronic Scale Test Log for observers who are using an approved NMFS electronic scale. |
| Offload Data | Opens Offload Data form for catcher boat and plant observers. |
| Halibut Deck Sorting | Opens the Halibut deck sorting data entry form for vessels that perform deck sorting. This button will only be visible to those vessels that deck sort for Halibut. |
| Species Comp Data | Opens Species Composition data form for vessel observers. The Flow Scale – MCP Scale Weight Comparison Form is used by observers on Catcher Processor trawlers and Mothership using a flow scale and is accessed through the Species Composition Data Form. |
| Length/Specimen Data | Opens Length/ Specimen Data form for vessel and plant observers. |
| Hook Count Data | Opens Hook Count collection form for longline observers. |
| Salmon Data | Opens Salmon data form for vessel and plant observers |

| Navigation Title | Navigation Function |
|----------------------------|---|
| Marine Mammal Data | Opens Marine Mammal Interaction and Marine Mammal Specimen form for vessel and plant observers. |
| Bird Data | Opens Bird Event, Bird Interaction and Bird Specimen Data form for vessel and plant observers. |
| Non-Fishing Day Data | Opens Non-Fishing day form for vessel and plant observers. |
| Fish/Crab/Invert. Tracking | Opens the whole fish, crab and invertebrate tracking form. |
| Inseason Message | Opens the Inseason Messages form where outgoing inseason messages are created and incoming inseason messages are read. |
| Prepare and Transmit | Opens Transmit option form for sending data to NMFS in Seattle. |
| Observer Images | Opens the Observer Image form. Allows observers to copy and transmit images. |
| Export Data for Vessel | Exports Atlas data for use by the vessel. Will not export inseason messages |
| Backup/Archive | Opens form to access the following functions: Backup and Archive data. |
| Reports | Opens the Reports form where a user can view their entered data in a quick readable format that more resembles the paper data form. |
| Logout | For closing out of the ATLAS program. |

Keyboard Shortcuts

Many Navigation Buttons in ATLAS can be activated by using the mouse or by using a keyboard shortcut. The keyboard shortcut-keys for each button can be identified by the underlined letter of each button. For example, if you look at the Trip Data navigation button (Figure 18-

9), you will notice that the “T” in Trip is underlined. To activate the Trip Data navigation button, using only the keyboard, press down and hold the <Alt> key then press down the <T> key.



Figure 18-7 Trip Data Navigation Button

The ATLAS program is like most Windows applications. When navigating through the program, you can either use the mouse or the keyboard. Basic keyboard navigation is as follows. The <Tab> key will move the cursor from one field to the next. The <Shift>+<Tab> keys will move the cursor backwards from a field to the previous field. If you are in a field and you want to move the cursor within that field, you use the left and right arrow keys. If you are entering a check mark in the check box field, you can use the space bar.

Drop Down Lists

Many of the data entry fields in ATLAS have a drop down list associated with that field. A drop down list is a list that contains all possible values for that particular field. When you are in a field that does contain a drop down list, you may see a down arrow next to that field. A user can then choose to either type in a value or click on the drop down arrow and expand the list. Once the list is expanded, the user can then select the value they want. Some drop down lists like the catcher boat ADF&G field in the Haul form will open up a pop-up window. If you click on the icon with the 3 dots next to the field a pop-up will appear and you can search for the value that you are looking for.

Required Data Entry Fields

Some of the data fields in ATLAS are “Required” fields. This means that a valid value must be entered in this field before you can move on to the next field or ATLAS form. For example, in the Trip Data form, the Trip Number is required. You will be unable to leave this field until you have entered a valid value.

Data Field Appearance

Some data fields in ATLAS will appear or disappear based on certain values in another field. For example,

when you open up the Haul Data form you will not see the Total Pots field. When you enter a value of 6, in the Gear Type field, then the Total Pots field will appear.

Data Entry Validation

When you enter data into a field in any form, it is possible that this field will automatically validate what has been entered. For example, when you are in the Deployment Time field in the Haul Data Form, you will not be able to enter a time of 2401, as that is not a valid time. This type of field validation will occur throughout ATLAS.

Replicating Fields

When you enter data into a form, some fields may already be filled out based on previous entries. This is to help reduce the amount of data entry the observer must do. For example, if you enter haul data and enter the gear code as 2, the next time you enter another haul the gear code field will already be filled out with the number 2. Remember to change a replicating field if the previous value is not correct for the current entry.

DATA ENTRY

The data entered in ATLAS will come from the following COMPLETED forms: Trip Form, Vessel Haul Form (VHF), Observer Haul Form (OHF), Hook Count & Spacing Form (Longliners only), Offload Form, Deck Forms and Bird Interaction and Bird Specimen Forms for short-tailed albatross. It is vital that when entering the data in ATLAS that it matches the COMPLETED FORM data. Entering data exactly how it is recorded on the forms will help speed up your debriefing.

TRIP DATA FORM

If you are assigned to a vessel (not a plant), you must always start by entering data in the Trip Data form. *No other data (except for non-fishing day and hook count data) can be entered in any other data form until you start a trip.* To open the Trip Data Form, select the Trip Data Navigation button from the ATLAS Main Menu (Figure 18-6). The Trip Data form will open (Figure 18-8).

| Trip Data | | Trip or Other Time Lost Comments | | Entered Trips | | | | |
|----------------------------|---|----------------------------------|----|---------------|--------|------------|------------|--------|
| Trip number | 2 | Crew size | 10 | Trip # | | | | |
| Fish in hold at departure? | | | | Select | Trip # | Start Date | End Date | Delete |
| | | | | Select | 1 | 10/10/2020 | 10/31/2020 | Delete |

Figure 18-8: Trip Data Form

Specifics on the Trip Data Form

To start a new trip, click on the Add Trip button found at the top of the form. The trip data entry form will open. The very first time you enter a new trip, the trip number will default to “1”. This may be changed by the user.

When you start a new trip, all the fields in the Trip Start area of the form must be filled out. The Trip End fields can be left blank until the trip is complete (*don't forget to update the Trip End fields when the trip is complete*). If you do enter a Trip End Port Code, the ATLAS program will expect you to fill out the Trip End fields. The bait code field should be filled out regardless of vessel type. It is not possible for you to enter and save another trip until the current open trip has trip end information entered. Once you have added all your trip data, select the Save Trip button at the top of the screen to save the data to the database. Once the data have been saved, you will see the trip listed on the right hand side of the screen in the Entered Trips list (Figure 18-9). Fishing time lost data can be added after the trip has been saved.

To add fishing time lost, find the trip in the entered trip list and click on the Select button for that specific trip. Select the Reason for the Time Lost in the drop down list and enter the amount of time lost, then click the Add/Update button.

Editing Trip Data

To edit trip data, first go to the list of entered trips found on the right hand side of the screen (Figure 18-9). Click

on the Select button next to the trip number you want to edit. All the previously entered trip data will appear in the trip entry window on the left hand side of the screen. Make the necessary changes, then select the Save Trip button to save your changes. To edit fishing time lost data, select the Reason for Time Lost from the drop down list and enter the new amount of time lost and click the Add/Update button. To delete a time lost record, select the Reason for Time Lost from the drop down list then click the Delete Time Lost button.

| Entered Trips | | | | |
|--|--------|------------|------------|---------------------|
| Trip # <input type="text"/> Filter Reset | | | | |
| Select | Trip # | Start Date | End Date | Delete |
| Select | 1 | 10/10/2020 | 10/31/2020 | Delete |

Figure 18-9: Editing Trip Data

HOOK COUNT DATA FORM

To open the Hook Count Data Form, select the Hook Count Data navigation button from the ATLAS Main Menu. If the vessel is using longline gear, then hook count collection data MUST be entered into ATLAS prior to entering any haul data.

Specifics on the Hook Count Data Form

Each hook collection must be assigned a unique collection number. An unlimited number of segment numbers may be added for each collection. To add a new hook collection click on the Add Collection button. Then enter the required collection data. Once the collection data has been entered then enter the segment data for that collection. Once the collection data and segment data has been entered then click on the Save Collection + Segment data button (Figure 18-10). To add more segment data click on the Add Segment button. A pop-up window will appear where additional segments can be entered. Multiple collections may be recorded for the same date.

| Collection Data | | Collections Entered | | | |
|--|---|---|--------------|---------------|---------------------|
| Collection Number <input type="text"/> | Month <input type="text"/> Day <input type="text"/> Year <input type="text"/> | Collection # <input type="text"/> Filter Reset Filter | | | |
| Segment Number <input type="text"/> | Segment Hook Count <input type="text"/> | Select | Collection # | # of Segments | Date |
| Hook Spacing <input type="text"/> cm | Save Collection + Segment | Select | 1 | 1 | 10/10/2020 |
| | | | | | Delete |

Figure 18-10: Hook Count Data Screen

Editing Hook Counts

To edit a hook count, find the collection number to edit in the table on the right side of the screen and click on the Select button next to the collection number. Once the specific collection data appears then the collection data can be edited. To edit segment data in a specific collection, find the segment number to edit and then click on the Select button next to the segment number. A pop-up will appear with the segment data where the data can be edited.

HAUL DATA FORM (VHF & OHF)

To open the Haul Data Form, select the Haul Data Navigation button from the ATLAS Main Menu (Figure 18-6). The Haul Data Form will open (Figure 18-11)

The screenshot shows the ATLAS Haul Data Form with three main sections: Vessel Haul, Observer Haul, and Entered Hauls. The Vessel Haul section includes fields for Gear Type (2 - Pelagic Trawl), Trip #, Haul #, IFQ, Vessel Type (1 - Catcher/Processor Vessel), Gear Perf, Location Code (R - Retrieve), Purpose Code (CA), and Gear Deployment details (Month, Day, Year, Time, Lat, Lon, Avg Bottom, Gear Depth, Meters/Fathoms). The Observer Haul section includes Haul Sampled By, RST on Haul, RBT on Break, MML Montrd, Discard Weight, Trawl Vessels, Observer Est, Haul back observed for, and Haul Short Wired. The Entered Hauls section is a table with columns for Haul #, Trip #, Retrieval Date/Time, and Delete, showing one entry for Haul # 1, Trip # 1, on 10/10/2020.

Figure 18-11: Haul Form (VHF & OHF)

Specifics on the Haul Data Form

To start adding a new haul, click on the Add Haul button at the top of the screen. The haul entry form will open. The Vessel Haul and Observer Haul Forms will both appear on the screen. *It is important to note that the Purpose Code field will default to “CA.” This should not be changed unless otherwise instructed to by Observer Program staff.* Once you have added all your vessel haul and observer haul data, select the Save Haul button at the top of the screen to save the data. Once the data have been saved, you will see the haul listed on the right hand side of the screen in the Entered Hauls list. When you begin adding another haul, some of the fields will automatically be pre-filled based on entries from previous hauls.

Assigning Hook Count Data to a Haul

Once a hook count has been saved, it may be assigned to a specific haul within the haul form. To assign a hook count to a haul go to the Observer Haul section in the haul screen and then click the drop down button next to the Hook Count Collection field. Select the appropriate hook count from the drop down list. Once the hook count collection number has been entered the total number of hooks will be calculated by ATLAS (Figure 18-12).

If the total number of hooks in a set is different from the value calculated by ATLAS, a different value may be entered by the user (known as a Hook Override). To override the ATLAS calculated value and enter a different number of total hooks, click on the Toggle button in the Hook Override field. Select OK to the message box that appears that you want to enter your own total number of hooks. The Hook Override will now change to a “YES” and the total hooks field will become editable and the user can enter their own value for total hooks. When the user enters their own total hooks, the numbers in the field will become blue. If the user wants ATLAS to recalculate the total hooks value, then select the Toggle button again and ATLAS will delete the total hooks that was previously entered and will automatically entered the calculated total hooks.

This close-up screenshot shows the Observer Haul form. The Hook Override field is set to "NO" with a "Toggle" button next to it. The Hook Count Collection field is set to "1 (10/10/2020) (1 segment)". Below this, the # Seg / Set is 3.00 and the # Hooks / Seg is 3210. The Total Hooks field is 9630, which is highlighted in blue. Other fields include Haul Sampled By (44556), RST on Haul (Y - Yes - Th), RBT on Break (NO - obser), Sample Design (7 - System), Sample Unit Type (1 - Gear), MML Montrd (33 %), Vessel Est (50.00 MT), and Discard Weight (200 kg). The Longline Vessels section is also visible at the bottom.

Figure 18-12: Assigning Hook Counts to a Haul

On snap gear vessels, you must perform a Hook Override on every haul. Click on the Toggle button in the Hook Override field and then select OK to the message box that appears. Then click in the Total Hooks field and physically type in the actual hook count value on every haul, even if the ATLAS-calculated value is the same as the value you type in. This will prevent ATLAS from recalculating the total hooks when you update the hook collection later

Editing Haul Data

To edit haul data, first go to the list of entered hauls found on the right hand side of the screen (Figure 18-

12). Click on the Select button next to the haul number you want to edit. All the previously entered haul data will appear in the haul entry window on the left hand side of the screen. Make the necessary changes, then select the Save Haul button to save your changes.

| Entered Hauls | | | | |
|--|--------|--------|---------------------|---------------------|
| Haul # <input type="text"/> Filter Reset | | | | |
| Select | Haul # | Trip # | Retrieval Date/Time | Delete |
| Select | 2 | 1 | 10/12/2020 (0506) | Delete |
| Select | 1 | 1 | 10/10/2020 (0300) | Delete |

Figure 18-13: Editing Haul Data

When editing haul data, if you edit a retrieval position, this might impact previously entered Halibut Deck Sort (HDS) data and/or previously entered species composition Halibut data where you used the Halibut worksheet to get Halibut weights based on a length. The derived HDS weights and Halibut worksheet weights are based on retrieval positions. If the retrieval position change and this does impact the data, Atlas will give you a message in the Haul form when you save your changes that this associated Halibut data has been impacted. It’s important to read these messages carefully and follow the instructions in the messages to update the HDS data and/or the Halibut data entered used from the Halibut worksheet.

OFFLOAD DATA FORM

To open the Offload Data Form, select the Offload Data Navigation button from the ATLAS Main Menu (Figure 18-6). The Offload Data form will open. (Figure 18-14).

Figure 18-14: Offload Data Form

Specifics on the Offload Data Form

The Offload Data Form will be filled out by observers assigned to catcher boats and observers assigned to a plant. To start adding a new offload, click on the Add Offload button at the top of the screen. The offload entry form will open. If you are an observer assigned to a catcher boat, you must fill out the trip number field. An offload may have more than one trip number assigned to it. In the trip selection area first select the trip number you want to assign to the offload by clicking on the trip number then click the “right” arrow (see Figure 18-14). Repeat this until all the valid trips for this offload have been assigned. To remove a trip from an offload, click on that trip number and press the “left” arrow. If you are an observer assigned to a plant, the first field you need to fill out is the delivery number. Once you have added all your offload data, select the Save Offload button at the top of the screen to save the data. Once the data have been saved you will see the offload listed in the Entered Offloads list on the right hand side of the form. When you begin adding another offload many of the fields will automatically be filled out based on entries from previous offloads.

Figure 18-15: Offload Form with Trips

Editing Offload Data

To edit offload data, first go to the list of entered offloads found on the right hand side of the screen (Figure 18-16). Click on Select button next to the offload you want to edit. All the previously entered offload data will appear in the offload entry form on the left hand side of the screen. Make any necessary changes then click the Save Offload button to save your changes.

| Select | Offload # | Offload Date | Offload Weight | Delete |
|--------|-----------|--------------|----------------|--------|
| Select | 1 | 10/11/2020 | 123456 LB | Delete |

Figure 18-16: Editing Offload Data

NON-FISHING OR NON-DELIVERY DAY FORM

To open the Non-Fishing Day Form, select the Non-Fishing Day Data button from the ATLAS Main Menu (Figure 18-6). The Non-Fishing Day form will open (Figure 18-17). Plant observers will use the Non-Delivery Day Form.

| Edit | Date | Haul # | Delete |
|------|------------|--------|--------|
| | 10/12/2020 | 2 | |
| | 10/10/2020 | 1 | |

Figure 18-17: Non Fishing Day Form

Specifics on the Non-Fishing or Non-Delivery Day Form

Non-fishing or non-delivery day information must be filled out by both vessel and plant observers. To start adding a new non-fishing or non-delivery day, click on the Add button at the top of the screen. The data entry form will appear. Enter the date and positions of the non-fishing day (date only for plant observers). After adding all your data, click on the Save button and your non-fishing/non-delivery day information will be saved. Once the data have been saved, you will see the non-fishing/non-delivery day listed on the right hand side of the screen in the entered list of non-fishing days (non-delivery days for plant observers) and haul retrieval dates.

Editing Non-Fishing or Non-Delivery Day Data

To edit non-fishing/non-delivery day data, go to the list of entered Non-Fishing or Non-Delivery Days and Haul Retrieval Dates found on the right hand side of the screen (Figure 18-18). Find the non-fishing/non-delivery day you want to edit and click on the Edit button for that row in the list. The data will appear in the Non-Fishing or Non-Delivery Day entry form on the left hand side of the screen. Make the necessary changes and then click the Save button.

| Edit | Date | Haul # | Delete |
|------|------------|--------|--------|
| | 10/12/2020 | 2 | |
| Edit | 10/11/2020 | NF | Delete |
| | 10/10/2020 | 1 | |

Figure 18-18: Editing Non Fishing Day Form

FLOW SCALE- MCP SCALE WEIGHT COMPARISON DATA FORM

Flow Scale – MCP Weight Comparison data is only entered by observers who are on a Catcher Processor trawler or Mothership vessel that is using a flow scale. Before adding these data, you must have first entered haul data. To access the Flow Scale – MCP Scale Weight Comparison Form, select the Species Comp Data Button on the Main Screen of ATLAS (Figure 18-6). This will open the list of entered Hauls/Offloads. Find the row that contains the haul for which you are entering these data. Once the row has been located, click the Select button in that row. The Flow Scale Weight button will now appear in the lower right corner of the screen. Click on the Flow Scale Weight button to open the form. (Figure 18-19).

| Select | Type | Number | Sample Count |
|--------|---------|--------|--------------|
| Select | Haul | 2 | 0 |
| Select | Haul | 1 | 0 |
| Select | Offload | 1 | 0 |

Figure 18-19: Flow Scale Weight Button

Specifics on the Flow Scale – MCP Scale Weight Comparison Data Form

To start adding data click on the Add button. Once the entry form opens, enter all the required data (Figure 18-20). After adding all your data, click on the Save button and the data will be saved. Once the data have been saved, you will see the entered data listed on the right hand side of the screen in the Entered Flow Scale list (Figure 18-21).

Figure 18-20: Flow Scale - MCP Scale Weight Comparison Form

Editing Flow Scale – MCP Scale Weight Comparison Data

To edit these data, go to the list of entered data found on the right hand side of the screen (Figure 18-21). Find the record you want to edit and click on the Select button in that row in the list. The data will appear in the data entry form on the left hand side of the screen. Make the necessary changes and then click on the Save button.

| Select | Sample # | Date | Start Wt | End Wt | MCP Wt | Delete |
|--------|----------|------------|----------|----------|-----------|--------|
| Select | 1 | 10/10/2020 | 12003 kg | 13002 kg | 998.00 kg | Delete |

Figure 18-21: Flow Scale - MCP Scale Weight Comparison Form with Data

SPECIES COMPOSITION DATA FORM

Before adding species composition data, you must have already entered a haul or offload. To open the Species Composition Data Selection Form, select the Species Comp Data navigation button from the ATLAS Main Menu (Figure 18-6). The Species Composition Data Selection Form will open (Figure 18-22).

Figure 18-22: Species Composition Data Selection Form

Specifics on the Species Composition Data Form

To add species composition data, find the haul or offload in the list of entered Hauls/Offloads found on the right hand side of the screen. Once the haul or offload has been located in the entered list, click on the select button next to the haul number or offload number that species composition data will be entered for. The haul or offload number will appear in the sample list in the lower right hand screen below. Highlight that haul or offload number and click on the New Sample button. When the New Sample button is selected, the species composition data entry form will open (Figure 18-23).

Adding Species Composition Data

After selecting the New Sample button, the species composition data form will open. The first field will be the Sampled By field. This field will automatically be filled out based on the cruise number that was entered in the Haul Data Form in the Haul Sampled By field. If the cruise number is the same then leave the field entered as is but if a different observer collected this sample then enter the cruise number of the observer who collected this sample. The next field to enter is the Sample Number field. Once the sample number field is entered, you then must enter the sample weight for a trawl vessel or the number of segments or pots for a fixed gear vessel. For a longliner, the total number of sampled hooks is a calculated value based on the number of segments sampled and the hook count collection assigned to the haul. If the total number of hooks sampled is different than the calculated value, this number may be entered directly by clicking on the Toggle button then entering the value in the Sampled Hooks/Pots field.

Figure 18-23: Species Composition Form with Data Entry Form Open

Once all the required sample information is completed the species composition data for the sample can be entered into the bottom left hand side of the screen. If you enter the species code, the species name field will be filled out based on what species code has been entered. If you enter the species name first, then the species code will be filled out based on what species name was selected. *Many species have similar names; ensure you select the correct code and name!* Use only those species codes listed in the species code lists beginning on A-21. Next the species number and species weight must be entered. Depending on what species is entered, the sex field may appear or disappear. The last field to enter is the percent retained field. Once these data have been added, select the Save SC button found in the lower left hand side of the species composition data entry form. The entered species will be added to the Species Composition List (Figure 18-24). As data is entered in the species composition form, ATLAS will display a list of sample issues. The sample issues must be fixed before clicking on the Close Sample Panel button. The Close Sample Panel button will not be available for use until all issues have been resolved.

If you are entering species composition data and you enter species code 101 (Pacific Halibut), the Halibut Worksheet button will appear (Figure 18-25). The Halibut Worksheet can be used to calculate halibut weights based on lengths or estimated lengths. **(DO NOT USE THIS WORKSHEET IF YOU ACTUALLY WEIGHED THE HALIBUT)** When the Halibut Worksheet opens, enter the length or estimated length of the Halibut and the number of Halibut at that length. Once the length and number have been entered then click on the Submit button. Continue to add Halibut lengths and numbers until they have all been entered.

Once all the Halibut data have been entered, click on the Transfer to Species_Comp button. The total number of Halibut and total weight of Halibut will be transferred over to the species composition data entry form. To edit Halibut worksheet data, click on the Halibut worksheet button and the Halibut data window will open and all the entered Halibut data will be available.

Figure 18-24: Species Composition List

Figure 18-25: Halibut Worksheet Button

Figure 18-26: Halibut Worksheet

With the exception of salmon, tanner, and king crab species, ATLAS allows you to enter multiple lines of data for a single species when entering composition records. When you enter salmon, tanner, and king crab species that have an associated sex code, sum the lines of data on your Deck Form to enter these as a single line of data by sex into ATLAS (Figure 18-27). *This only applies to salmon and crab species that have a corresponding sex in the species composition data.* All other species must be entered into ATLAS line by line to facilitate the debriefing process.

| Sample #: | 3 | Sub-Sample #: | | Sample Size: | 5 | # of Segments | 0 | # of Sampled Hooks: | |
|--------------------|-----------------------|---------------|-----------------------|-------------------------|---|-------------------|---|---------------------|--|
| Presorted | <input type="radio"/> | Combined | <input type="radio"/> | Unable to Follow Design | <input type="radio"/> | No Fish in Sample | | | |
| Species | Sex | # | Weight | % ret. | Length, viability, injury, specimen tally data, measurements, bird observations, etc. | | | | |
| -----KEYPUNCH----- | | 278 | 218.2 | | | | | | |
| P cod | | 105 | 0 | 100 | | | | | |
| AK SKATE | | 12 | 48.8 | 0 | | | | | |
| pollock | | 7 | 9.8 | 20 | | | | | |
| YIL | | 33 | 30.4 | 0 | | | | | |
| Bairdi | F | 12 | 14.4 | 0 | | | | | |
| Bairdi | F | 23 | 20.8 | 0 | | | | | |
| Bairdi | F | 19 | 19.7 | 0 | | | | | |
| Bairdi | M | 36 | 44.6 | 0 | | | | | |
| Bairdi | M | 31 | 29.7 | 0 | | | | | |

= 54 @ 54.9 kg

= 67 @ 74.3 kg

Enter the summed total into Atlas

Figure 18-27: Summing Up Prohibited Species on Deck Forms

Before the species composition data entry form can be closed, a keypunch record must be entered as part of the species composition data. To enter a keypunch record use a species code of 999 (Figure 18-28). The keypunch must equal the sum of the species numbers and sum of species weights. Once all species have been added, you can close the form by selecting the Close Sample Panel button.

Edit Sample Number: 1

Sampled by: 44556 | Sample Number: 1 | Presorted?: No | Total Sample Wt: 92.10 kg | Combined Sample: No

Species Composition

| Select | Species | Species Name | Number | Weight | % Ret | Sex | Delete |
|--------|---------|----------------|--------|--------|-------|-----|--------|
| Select | 201 | POLLOCK | 55 | 41.05 | 100 | | Delete |
| Select | 202 | PACIFIC COD | 21 | 51.05 | 100 | | Delete |
| Select | 999 | Keypunch Check | 76 | 92.1 | | | Delete |

Figure 18-28: Keypunch Check in Species Composition

Longline or Pot Samples With No Fish

If you are sampling an offload, longline set or pot set and there are no fish in the sample create a sample entry for the haul, number it appropriately, enter the sample size (total delivery weight, sample size in hooks or pots), and choose “N” for “Species Comp in Sample?”(Figure 18-29)

Adding Sample for Haul Number: 2

Sampled by: 44556 | Sample Number: 2 | Presorted?: No | Combined Sample: No | Hook Override: NO

Fish in Sample?: No | # of Segments: 2.00 | Sampled Hooks: 4628

Figure 18-29: Indicating There Were No Fish in the Sample

Adding a Sub Sample to Species Composition Data

If you are on a vessel using trawl gear and you want to enter subsample species composition data, you must have first entered a sample that included 2 different species with a weight and number of 0. Once the sample data have been entered, you can enter your subsample data into the Species Composition Form.

Using the Sample List found on the lower right hand side of the screen, highlight the sample for which you want to enter a subsample (Figure 18-30). After you highlight that record, click on the New Sample button. The Species Composition Data Entry Form will open. You can begin to enter your subsample data.

Entered Haul/Offload

Haul/Offload #: [Filter] [Reset]

| Select | Type | Number | Sample Count |
|--------|------|--------|--------------|
| Select | Haul | 2 | 1 |
| Select | Haul | 1 | 3 |

Sample List (30,213 KGs observer est)

- Haul: 1
 - Sample: 1 (Weight: 92.1)
 - Sample: 2 (Weight: 77.05)
 - Sample: 3 (Weight: 128)

Figure 18-30: Adding Subsample Data

Editing Species Composition Data

To edit species composition data, first go to the list of entered hauls and offloads found on the right hand side of the screen (Figure 18-22). Find the haul or offload that contains the data you want to edit and click on the Select button found in that row. On the bottom right side of the screen, you will see a Sample List that contains all the species composition data entered for the selected haul. (Figure 18-31).

Using the Sample List (Figure 18-33), find the sample number that you want to edit. Click once on the sample you want to edit then click on the Edit Sample button (Figure 18-32).

Entered Haul/Offload

| Select | Type | Number | Sample Count |
|--------|------|--------|--------------|
| Select | Haul | 2 | 1 |
| Select | Haul | 1 | 4 |

Sample List (30,213 KGs observer est)

- Haul: 1
 - Sample: 1 (Weight: 92.1)
 - Sample: 2 (Weight: 77.05)
 - Sample: 3 (Weight: 128)
 - Subsample: 301

Figure 18-31: Editing Species Composition From Sample List

Once the species composition data entry form is open, you may begin editing any field. To edit a specific species, find that species in the list of entered species (Figure 18-32) and click on the Select button found in that row. The species information will appear in the edit species composition section at the bottom of the form. Now you can begin editing any field. Once you are done editing a specific record, always click on the Save SC button.

Edit Sample Number: 1

| Sampled by | Sample Number | Presorted? | Total Sample Wt | Combined Sample |
|------------|---------------|------------|-----------------|-----------------|
| 44556 | 1 | No | 92.10 kg | No |

Species Composition

| Select | Species | Species Name | Number | Weight | % Ret | Sex | Delete |
|--------|---------|--------------|--------|--------|-------|-----|--------|
| Select | 201 | POLLOCK | 55 | 41.05 | 100 | | Delete |
| Select | 202 | PACIFIC COD | 21 | 51.05 | 100 | | Delete |

Edit Species Composition

| Species Code | Species Name | Number | Weight | % Retained |
|----------------------|----------------------|----------------------|-------------------------|----------------------|
| <input type="text"/> | <input type="text"/> | <input type="text"/> | <input type="text"/> kg | <input type="text"/> |

Figure 18-32: Editing Species Composition Data Entry Form

LENGTH DATA FORM

Before adding length data, you must first have entered haul, or offload, or species composition data. Length data may come from any of these forms. To open the Length Form, select the Length / Specimen Data navigation button from the ATLAS Main Menu (Figure 18-6). The Length Specimen Selection Form will appear (Figure 18-33).

Once the Length Specimen Selection Form opens, find the row containing the haul number and/or sample number or offload number for which you want to enter length data and click on the Select button in that row to open up the Length List for that selected haul/offload/sample (Figure 18-33).

Length - Specimen List

Haul/Offload # Filter Reset

| Select | Type | Number | Sample Number | Length Count | Specimen Count |
|--------|------|--------|---------------|--------------|----------------|
| Select | Haul | 2 | | 0 | 0 |
| Select | Haul | 2 | 1 | 0 | 0 |
| Select | Haul | 1 | | 0 | 0 |
| Select | Haul | 1 | 1 | 0 | 0 |
| Select | Haul | 1 | 2 | 0 | 0 |
| Select | Haul | 1 | 3 | 0 | 0 |
| Select | Haul | 1 | 301 | 0 | 0 |

Figure 18-33: Length Specimen Selection Form

Specifics on the Length Data Entry Form

To add a new length, click on the New Length button found at the bottom of the Length List (Figure 18-34). Once the Length Data Entry Form opens, enter the species code or the species name (Figure 18-35).

If you are entering length data from a sample, only those species codes that were in your sample will appear in the species code list. If you are entering length data from a haul or offload, the full species code list will be available.

Length List

| Select | Specimen | Delete | Species | Species Name | Specimen Count | Sample Design | Sex | Length Size | Frequency | Egg | Viability | Injury |
|--------|----------|--------|---------|--------------|----------------|------------------------------|------|-------------|-----------|-----|-----------|--------|
| Select | Specimen | Delete | 201 | POLLOCK | 0 | 1 - Stratified Opportunistic | Male | 10 | 1 | | | |

Figure 18-34: Length List

A new record must be entered for each specific sex/length combination collected for a species (Figure 18-34). Fill in the species code, sample design, sex, length and frequency fields and click the Save button to save the length record.

The saved length data will appear in the Length List at the top of the data form (Figure 18-35). Atlas will automatically populate the species and sex fields for the next entry. Change the species field or the sex field if it is different for the new record. For Halibut and crab species more fields will appear in the length data entry form. Once all fields have been entered, click the Save button at the bottom of the entry panel. After clicking the Save button, the cursor will move automatically to the sex field and the entered length data will appear in the Length List (Figure 18-35).

| Select | Specimen | Delete | Species | Species Name | Specimen Count | Sample Design | Sex | Length Size | Frequency | Eggs | Viability | Injury |
|--------|----------|--------|---------|--------------|----------------|-------------------|--------|-------------|-----------|------|-----------|--------|
| Select | Specimen | Delete | 201 | POLLOCK | 0 | 6 - Simple Random | Female | 47 | 1 | | | |
| Select | Specimen | Delete | 201 | POLLOCK | 0 | 6 - Simple Random | Female | 52 | 1 | | | |
| Select | Specimen | Delete | 201 | POLLOCK | 0 | 6 - Simple Random | Male | 47 | 1 | | | |

Length Data

Species Code

Sample Design Sex

Length Size Frequency

Figure 18-35: Length List with Length Data Entry Form

Editing Length Data

To edit length data, first go to the Length List. Find the row that contains the data you want to edit and click the Select button in that row. (Figure 18-36). The selected data will appear in the Length Data Form to edit. You can make any changes to the data from here. The only field you can't edit is species code. If you need to change the species code, you will need to delete the length record then re-enter the length and any specimen records. After making your edits, select the Save button to save your changes.

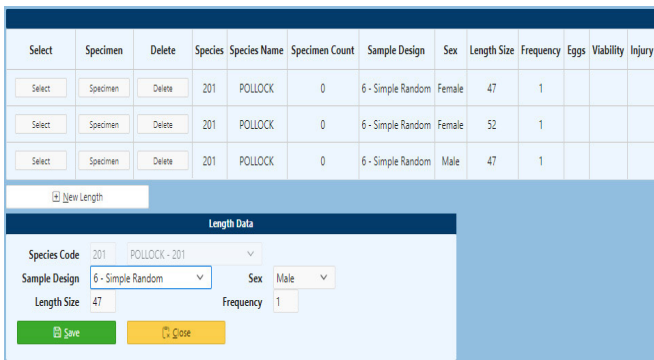

Figure 18-36: Edit Length List

SPECIMEN DATA FORM

Before adding specimen data, you must have first entered a length record. Each specimen record is entered for a specific length record. The only way to access the specimen entry form is through the Length/Specimen Button on the Main Screen of ATLAS (Figure 18-6). This will open the Length Specimen Selection form (Figure 18-33). Find the row for the haul/sample/offload that the specimens will be associated with and click on the Select button in that row. This will open the Length List. Then find the row that contains the length where you will be entering specimen data. Click on the Specimen button in that row. (Figure 18-37).



Figure 18-37: List of Entered Lengths

Specifics on the Specimen Data Entry Form

Once the Specimen Data Entry Form is open, the cursor will automatically go to the Specimen Number field where you can enter the specimen number. (Figure 18-38). The next field is the weight field. If no weight was taken then leave the weight field blank. If a valid weight is entered, the Sex-Length-Weight Sample row will automatically receive a check mark (Figure 18-39). For all the different specimen types that are collected, use the mouse or the space bar on the keyboard to place a check mark in the associated specimen collected box. Some specimen types require additional data to be entered such as Otolith Bar Code and Maturity Scan. Once all the data have been added click on the Add/Save button found out the bottom of the screen (Figure 18-40). The saved specimen data can now be seen in the Specimen List on the right hand side of the screen. (Figure 18-41).

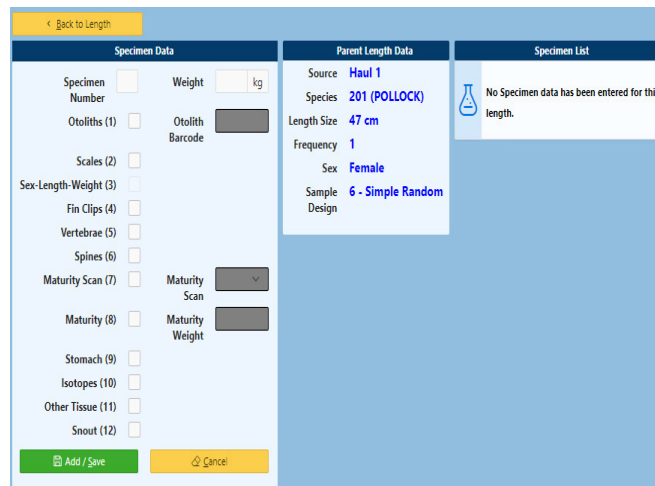

Figure 18-38: Specimen Data Entry Form

Figure 18-39: Specimen Window with Check Mark

Figure 18-40: Add/Save Button in Specimen Data Entry Form

| Specimen List | | | |
|---------------|------------|----------------|--------|
| Select | Specimen # | Specimen Count | Delete |
| Select | 1 | 3 | Delete |

Figure 18-41: Saved Specimen Data on Specimen List

Editing Specimen Data

To edit specimen data, first go to the Length List. Lengths with corresponding specimen records can easily be

identified by the Specimen Count Column found in the Length List. Find the row that contains the data you want to edit and click on the Specimen button. (Figure 18-42).

| Select | Specimen | Delete | Species | Species Name | Specimen Count | Sample Design | Sex | Length Size | Frequency | Egg | Viability | Injury |
|--------|----------|--------|---------|--------------|----------------|-------------------|--------|-------------|-----------|-----|-----------|--------|
| Select | Specimen | Delete | 201 | POLLOCK | 3 | 6 - Simple Random | Female | 47 | 1 | | | |
| Select | Specimen | Delete | 201 | POLLOCK | 0 | 6 - Simple Random | Female | 52 | 1 | | | |
| Select | Specimen | Delete | 201 | POLLOCK | 0 | 6 - Simple Random | Male | 33 | 2 | | | |

Figure 18-42: Entered Length List

Once the Specimen Data Entry Form is open, find the specimen record you want to edit in the Specimen List on the right hand side of the screen and click on the Select button in that row. The selected data will appear in the Specimen Data Entry Form on the left hand side of the screen (Figure 18-43).

Figure 18-43: Selected Specimen Data Entry Form

You can make any changes to the data from here. After making your edits, select the Add/Save button to save your changes. To delete all the specimens for a specific specimen number, click the Delete button in the Specimen List on the right hand side of the screen.

Finding Specific Length Specimen Records

To use the search feature to find a specific specimen, click the Length/Specimen Data Button from the ATLAS Main Menu (Figure 18-6). Then click on the Find Specimen button (Figure 18-44).

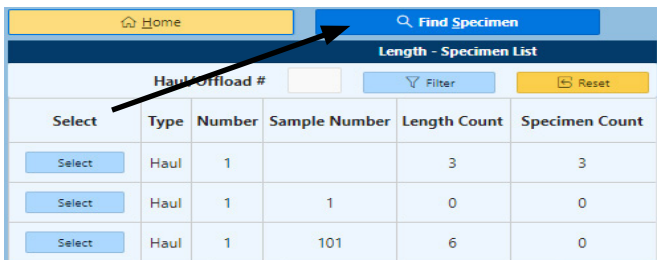

Figure 18-44: Find Specimen Button

The Find Specimen window will now appear. There are two ways to find a length specimen record. To search for a specimen by its specimen number, select the Specimen Number radio button. To search for a specific bar code, select the Barcode radio button. Then in the find box, enter the number you are looking for and press the find button (Figure 18-45).

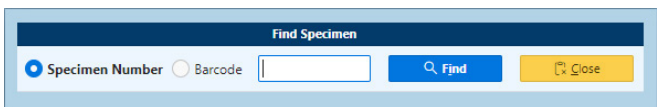

Figure 18-45: Find Specimen Feature

If no records are found, no rows will be returned. If specimen records are found, those rows will be returned to the screen (Figure 18-46). Find the row that has the record that you want and click on the select button in that row. The Length List will open (Figure 18-37). You can then navigate to the appropriate length record that has the specimen record you want to work with and click on the Specimen button.

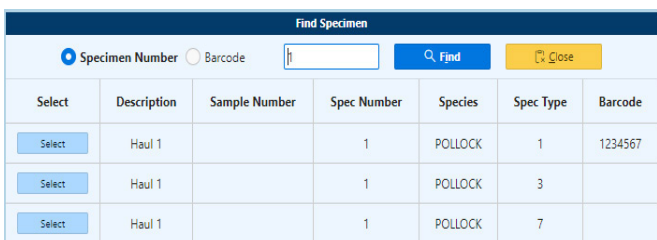

Figure 18-46: Specimen Found Using Search Feature

SALMON DATA FORM

To open the Salmon Data Form, select the Salmon Data Navigation button from the ATLAS Main Menu (Figure 18-6). The Salmon Data Form will open (Figure 18-47)

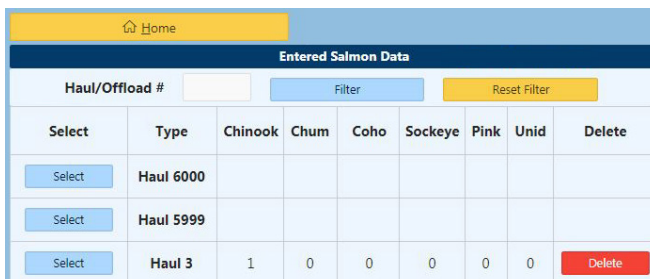

Figure 18-47: Salmon Data Form

Specifics on the Salmon Data Form

To start adding salmon data, go to the list of Entered Salmon Data found on the right hand side of the screen. Find the haul or offload number you want to enter data for and click on the Select button in that row. The Salmon Data Entry form will open. Enter the data in the form, then click on the Save button to save your entered data. Refer to the “Salmon Retention Data in the Pollock Fishery” on page 12-16 of this manual for specifics on completing the Salmon Data Form.

Editing Salmon Data

To edit salmon data, first go to the list of Entered Salmon Data found on the right hand side of the screen (Figure 18-48). Find the haul or offload number that you want to edit and click on the Select button in that row. All the previously entered salmon data will appear in the Salmon Data Entry form on the left hand side of the screen. Make the necessary changes, then click the Save button to save your changes.

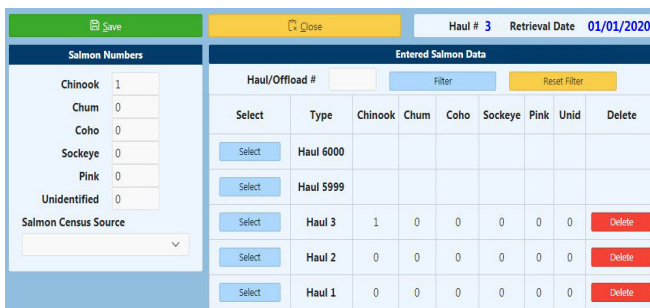

Figure 18-48: Entered Salmon Data List

MARINE MAMMAL DATA FORM

Before adding marine mammal data, you must have already entered a trip or haul or an offload. A marine mammal interaction may be documented for a trip,

a haul or an offload. To open the Marine Mammal Data Selection Form, select the Marine Mammal Data Navigation button from the ATLAS Main Menu (Figure 18-6). The Marine Mammal Data Selection Form will open. (Figure 18-49).

Figure 18-49: Marine Mammal Data Selection Form

Specifics on the Marine Mammal Data Form

To add a new marine mammal find the trip, haul or offload in the Entered List of Hauls/Offloads/Trips found on the right hand side of the screen. Once the haul, offload, or trip has been located in the Entered List, click on the Select button in that row. The trip number, haul number, or offload number will appear at the top of the screen. Click on the New Mammal button at the top of the screen (Figure 18-49).

Adding Marine Mammal Data

After selecting the New Mammal button, the mammal Data Entry Form will appear (Figure 18-50). In the mammal Data Entry Form, use the drop down list next to the species name field to select the species name of the marine mammal. The species code field will automatically update. If you change the species code, the marine mammal name will change when you leave the species code field. In the # of animals field, enter the number of animals. After entering the total # of animals, then enter the required mammal interaction information. *Don't forget the comment field is required. Please try to supply as much information as possible about this interaction and mammal.* Once you have entered all the interaction data, you must click on the Save button. This will save your interaction information. Your interaction data are viewable in the Interaction List (Figure 18-51).

Figure 18-50: Mammal Data Form with Mammal Data Entry Form Open



Any freshly caught pinniped and/or cetacean carcass must be reported to Observer Program staff immediately via an inseason message.

Figure 18-51: Interaction List

Editing Mammal Data or Interaction Data

To edit mammal data or interaction data, first go to the list of entered trips, hauls, or offloads found on the right hand side of the screen (Figure 18-52). Find the trip, haul, or offload that contains the data you want to edit and click on the Select button in that row. On the left side of the screen in the Mammal Report List (Figure 18-52), click on the Select button in the row of the mammal you want to edit.

| Select | Species Code | # of Animals | Delete |
|--------|-------------------|--------------|--------|
| Select | Killer whale (OO) | 13 | Delete |

| Select | Type | Records |
|--------|--------|---------|
| Select | Haul 2 | 0 |
| Select | Haul 1 | 1 |
| Select | Trip 1 | 0 |

| Select | Specimen | # of Specimens | # of Animals | Interaction | Condition | Observed | Comments | Delete |
|--------|----------|----------------|--------------|-----------------------|-----------------|----------|---|--------|
| Select | Specimen | 0 | 3 | 10 - Feeding On Catch | 3 - Live Animal | Yes | Identifying characteristics were a large dorsal fin and white around the eyes and saddles. They were seen feeding on gear.. | Delete |

Figure 18-52: Editing Mammal Interaction Data

The mammal interaction records will appear in the Interaction List (see Figure 18-51). Here you can change the marine mammal species name, code or the # of animals.

If you want to edit a specific marine mammal interaction, find that interaction in the Interaction List (Figure 18-51) click on the Select button in the row of data you want to edit. The Mammal Data Entry Form will appear where you can now edit the interaction data (Figure 18-53).

Figure 18-53: Mammal Data Form with Mammal Interaction Data Entry Form

Adding Mammal Specimen Data

Before adding mammal specimen data, you must have entered a marine mammal interaction. Once the marine mammal interaction data have been saved, you can view the specific mammal interaction in the Interaction List. (Figure 18-51). In the Interaction List, click on the Specimen button in the row of interaction data you want to add specimen data to . The Mammal Specimen Data Entry Form will now appear. Click on the New Specimen

button, add the required information, and click the Save button (Figure 18-54).

Figure 18-54: Mammal Specimen Data Entry Form

BIRD DATA FORM

To open the Bird Data Form, select the Bird Data button from the ATLAS Main Menu (Figure 18-6). The Bird Data Form will appear (Figure 18-55).

| Select | Event Number | Source | Species Records | Delete |
|--------|--------------|--------|-----------------|--------|
| Select | 1 | Haul 1 | 1 | Delete |
| Select | 2 | Trip 1 | 1 | Delete |

Figure 18-55: Bird Data Form

Adding Bird Interaction Data

After selecting the Bird Data button, the form will appear. Click on the Add Bird Event button at the top of the screen. (Figure 18-55). The Bird Data Entry Form will open (Figure 18-56).

Specifics on the Bird Data Form

The Bird Data Form will be filled out by any observer assigned to a vessel or plant. The form will be used for recording bird interactions or specimens and Bird Data may be recorded at the trip, haul, or offload level.



If you have an interaction involving a short-tailed albatross, you must also fill out the Bird Interaction, Activity and Species paper form and the Bird Specimen and Tag Information paper form (if specimens are collected) in addition to entering and reporting the data in ATLAS.

If the data for an interaction is collected directly from a haul; the date, time and position is not required by ATLAS. This information will be inherited from the retrieval position that was entered in haul form. If the interaction is from a trip or offload an exact date time and position must be entered in ATLAS. If the interaction involves a Short-Tailed Albatross, age data should be entered, this field will not appear for any other species (Figures 18-58).

Once the data has been entered in each section of the Bird Data Entry Form, click on the Save Interaction button at the top of the screen (Figure 18-56).

Figure 18-56: Bird Data Entry Form and Save Interaction Button

Figure 18-57: Bird Data Entry Form Species Section

Figure 18-58: Bird Data Entry Form Species Section With Short-Tailed Albatross

Adding Bird Specimen Data

To add bird specimen data, find the bird event number in the list of Entered Bird Events. Click on the Select button found in that row. (Figure 18-55). Once the Bird Data Entry Form opens for that event, you will see a list of Species Entries found on the right hand side of the screen. Find the species you want to add specimen data for and click on the Specimen button found in that row.

The Bird Specimen Entry Form will open (Figure 18-59). Click on the Add Specimen button at the top of the window. A unique specimen number is required for each specimen collected for a specific bird. If you are entering bird specimen data for a short-tailed albatross, the age of the bird will have to be reentered. This field will not appear for any other species. Enter all the required information and click the Save button. The specimen count in the Species Entries List will now show the number of specimens associated with that species. (Figure 18-57). Additional data must be entered for bird tag specimens (Figure 18-60).

Figure 18-59: Bird Specimen Entry Form

Figure 18-60: Bird Specimen Entry Form For Bird Tag Specimen

FISH/CRAB/INVERT. TRACKING FORM

To open the whole fish, crab and invertebrate tracking from, select the Fish/Crab/Invert. Tracking button from the ATLAS Main Menu (Figure 18-6). The form will open and then click on the New Specimen button at the top of the screen. The specimen tracking and verification form will now open (Figure 18-61). Enter all the required information in the screen. If the source of the data is Trip, then you will need to enter the date and latitude and longitude.

Figure 18-61: Specimen Tracking and Verification Form

Editing Fish/Crab/Invert. Tracking Data

To edit or delete whole fish, crab and invertebrate data, select the Fish/Crab/Invert. Tracking button from the ATLAS Main Menu (Figure 18-6). Find the row in the grid that you want to edit or delete. If you want to edit a record click on the Select button on the left side of the

grid. The selected data will appear and you can make the required changes. If you want to delete a record, click on the Delete button on the right side of the grid in the row where you want to delete data.

HALIBUT DECK SORT FORM

To open the Halibut Deck Sort Data Form, select the Halibut Deck Sort Data Navigation button from the ATLAS Main Menu (Figure 18-6). The Halibut Deck Sort selection form will now open (Figure 18-62).

| Select | Transferred Comp/Length | Haul # |
|--------|-------------------------|--------|
| Select | X | 3 |
| Select | X | 2 |
| Select | X | 1 |

Figure 18-62: Halibut Deck Sort Selection

Specifics on the Halibut Deck Sort Data Form

To start adding Halibut deck sorted data, go to the list of Entered Haul Data and find the haul number you want to enter data for and click on the Select button in that row. The Halibut deck sort form will open. Begin by entering the Halibut deck sort information. This will consist of a number of initial questions about the deck sort and a number of questions regarding the deck sort Halibut counts (Figure 18-63)

Figure 18-63: Halibut Haul Data

Once the initial Halibut deck sort haul data questions have been answered select the save button. If Halibut were assessed for viability then the assessed form will appear on the right hand side of the screen (Figure 18-64)

| | Column A | | Column B | | Column C | |
|---|----------------------|----------------------|----------------------|----------------------|----------------------|----------------------|
| | Length | Viability | Length | Viability | Length | Viability |
| 1 | <input type="text"/> | <input type="text"/> | <input type="text"/> | <input type="text"/> | <input type="text"/> | <input type="text"/> |
| 2 | <input type="text"/> | <input type="text"/> | <input type="text"/> | <input type="text"/> | <input type="text"/> | <input type="text"/> |
| 3 | <input type="text"/> | <input type="text"/> | <input type="text"/> | <input type="text"/> | <input type="text"/> | <input type="text"/> |
| 4 | <input type="text"/> | <input type="text"/> | <input type="text"/> | <input type="text"/> | <input type="text"/> | <input type="text"/> |
| 5 | <input type="text"/> | <input type="text"/> | <input type="text"/> | <input type="text"/> | <input type="text"/> | <input type="text"/> |

Figure 18-64: Assessed Halibut

Enter the length and viability of each Halibut assessed then select the Save button.

If no Halibut were assessed and only a count and length were taken of all Halibut during the deck sort, then the HDS Length Taken form will appear on the right hand side of the screen (Figure 18-65). Enter the lengths taken for each Halibut.

Figure 18-65: HDS Lengths Taken

If no Halibut were assessed and only some or none of the Halibut have a length then the following message will appear on the right hand side of the screen (Figure 18-66). Make sure to follow the directions from this message.

Figure 18-66: No Lengths Taken

Once all the Halibut deck sorted data has been entered for a haul then click on the Transfer to Comp/Length or Transfer to Comp button at the top of the screen (Figure 18-67). This is a critical step so that the appropriate sample/species composition record and length record (if necessary) are created in ATLAS.

Or

Figure 18-67: Transfer to Comp/Length or to Comp

Halibut Deck Sorting Weights

Once Halibut deck sorting lengths have been entered, Atlas will automatically calculate the correct weights for each Halibut measured and assessed. These weights are based on the retrieval latitude and longitude positions that were entered in the haul form. Once Atlas calculates the total weight of assessed Halibut and the total weight of all Halibut (discarded Halibut) you need to update the observer discard estimate and observer haul estimate in the Atlas haul form with the total discard weight of deck sorted Halibut. These weights can be found under the main Halibut deck sort page (Figure 18-68). Click on

the Edit Haul button found in the HDS page grid and the Atlas haul form will open so that you can update the correct fields.

| Total Discard Wt of Deck Sorted Halibut |
|---|
| 15.4 |
| 2.2 |
| .5 |

Figure 18-68: Total Discard Wt of Deck Sorted Halibut

Editing Halibut Deck Sorting Data

To edit or delete Halibut deck sorting data, select the Halibut Deck Sort button from the Atlas Main Menu (Figure 18-6). Find the row in the grid that you want to edit or delete. If you want to edit a record click on the Select button on the left side of the grid then make the necessary changes. When you make changes to any HDS data, you will always need to click on the transfer to comp/length or comp button.

POT OPENING DATA FORM

To open the Pot Opening Data Form, select the Pot Opening Data Navigation button from the ATLAS Main Menu (Figure 18-6). Then select the Add Pot button at the top of the form. The Pot Opening Data entry form will now open (Figure 18-69).

Figure 18-69: Pot Opening Data Entry Form

Specifics on the Pot Opening Data Form

Begin entering data about which Pot number you will be entering pot opening data for. Once the specific pot number has been entered then enter the specific pot opening data. Once an initial pot number and pot opening information has been entered, then click on the Save Pot button at the top of the screen to save the data. To add additional pot openings to the existing record, click on the Add Pot Opening button to add additional pot opening data. To add data for a different pot, click on the close button at the top of the screen then click on the Add Pot button at the top of the screen.

Editing Pot Opening Data

To edit or delete Pot Opening data, select the Pot Opening Data button from the Atlas Main Menu (Figure 18-6). Find the row in the grid (right hand side of the screen) that you want to edit or delete. If you want to edit a record click on the Select button on the left side of the grid then make the necessary changes and then save.

ELECTRONIC SCALE TEST LOG FORM

To open the Electronic scale test log form, select the Electronic Scale Test Log Navigation button from the ATLAS Main Menu (Figure 18-6). Then select the Add Serial number button at the top of the form. The Electronic Scale Test Log Data entry form will now open.

Specifics on the Electronic Scale Test Log Form

Begin by entering the serial number of the electronic scale that you are testing. Once the serial number has been added, then enter the results of each test weight and also select the cruise numbers of all the observers who participated in the test. Typically, you will be testing with 10kg, 25kg, and 50kg weights. Enter the results of each test amount. In the event that you use a different test weight amount you will need to record that specific test weight along with the result.

Editing Electronic Scale Test Log Data

To edit or delete Electronic Scale Test Log Data data, select the Electronic Scale Test Log button from the Atlas Main Menu (Figure 18-6). Find the row in the grid (right hand side of the screen) that you want to edit or delete. If you want to edit a record click on the Select button on the left side of the grid then make the necessary changes and then save.

OBSERVER IMAGES

To open the Observer Images form, select the Observer Images Navigation button from the ATLAS Main Menu (Figure 18-6). You will first receive a message box stating that uploading and transmitting any observer images should only be done when directed by FMA (Observer Program) staff. If you have been directed to upload and transmit an observer image off your NMFS supplied camera, then click on the Ok button to open the Observer Image Form.

Specifics on the Observer Images Form

The Observer Image form allows observers to upload images into ATLAS that are on the NMFS supplied camera. First turn on the NMFS supplied camera then using the camera cord that was supplied with the camera, plug that cord into the Atlas computer. The other end of the cord should be plugged into the camera. Wait a few seconds for the computer to recognize the camera. If the computer asks for permission to access the camera you will have to follow those prompts on the computer to allow access. Once the computer has recognized the camera, then select the Copy Images button. The Image Upload form will now appear (Figure 18-70).

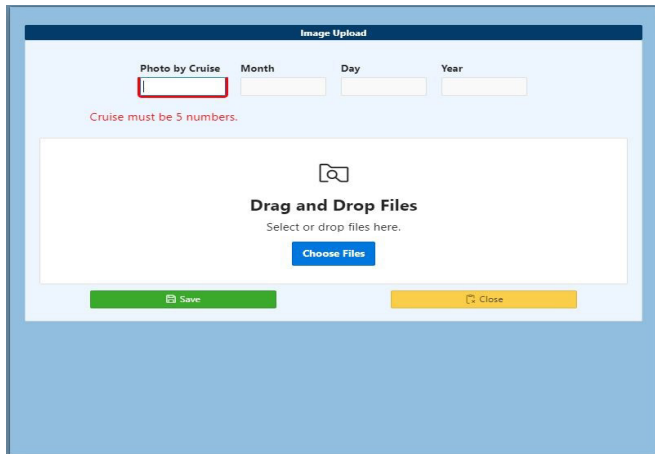

Figure 18-70: Image Upload Form

INSEASON MESSAGES

To open the inseason messages form, select the Inseason Messages Navigation button from the ATLAS Main Menu (Figure 18-6). If ATLAS is configured for one observer, the inseason messages screen will open in a new tab in the browser (Figure 18-71) allowing you to switch between the tab with your ATLAS data and

inseason messages for quick reference. If ATLAS is configured to allow multiple observer accounts, then an inseason message password screen will appear (Figure 18-72). Enter the current mail password for the observer who is accessing their inseason messages. You will only be able to see and read messages that have been created under your specific cruise number and sent to your specific cruise number.

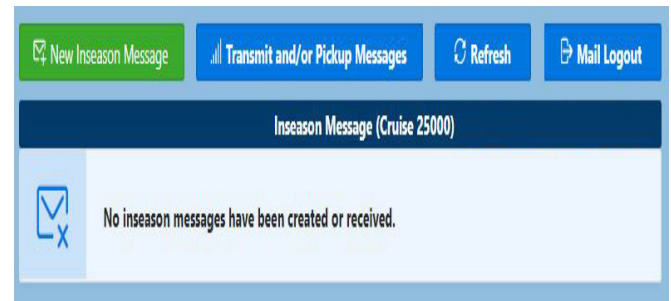

Figure 18-71: Inseason Message Screen

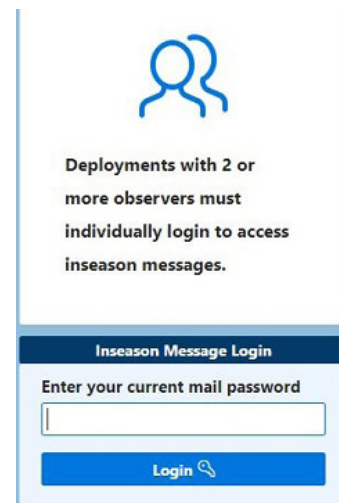

Figure 18-72: Inseason Message Password Screen

Specifics on the Inseason Message Screen

Inseason messages are a vital link between the observer and Observer Program staff. Inseason messages should only be used for observer related duties and issues, as well as technical problems. The inseason message screen will be used to create outgoing inseason messages (created by the observer) and to read incoming inseason messages (created by Observer Program staff).

Creating An Outgoing Inseason Message

To create an outgoing inseason message, click on the New Inseason Message button at the top of the screen.

The message entry window will open. Enter the current date, then begin entering your inseason message. Once the inseason message has been created, click on the Save button. Inseason messages are limited to 4000 characters. If you reach the character limit you will not be able to type anymore. Find a logical ending point and then create another message with the rest of your information. Your created outgoing inseason message can be viewed in the list of messages (Figure 18-73). Your created message will be transmitted the next time you prepare and transmit data or when you click on the Transmit Messages Now button.

| Select | Message # | Date | Type | Message | Delete |
|--------|-----------|------------|------|---|--------|
| Select | 1 | 01/01/2020 | OUT | Hello Inseason Advisor, I just boarded FV Cape Horn for my f... | Delete |

Figure 18-73: Inseason Message List and Transmit Messages Now Button

Transmitting Inseason Messages Only

To transmit inseason messages only, select the Transmit Messages button found in the Inseason Message Screen (Figure 18-73). This feature allows you to send an inseason message without sending any data. When the transmission occurs, any new or edited inseason message will be prepared and transmitted to Seattle and any incoming messages will be received. *New or edited inseason messages can also be prepared and transmitted using the Prepare and Transmit Screen.*

Reading An Incoming Inseason Message

Each time you successfully transmit data or inseason messages to Seattle, any incoming inseason messages will be picked up. Once the transmission is complete, go to the Inseason Message screen and see if any incoming messages were received. Once the inseason message screen opens, look in the list of messages. Find the Type column and look for any IN types. Once you have found a new IN message click on the select button found in that row (Figure 18-73) and the IN message can be viewed. Also, all un-read IN messages will be in bold.

Pickup Messages Button

Incoming inseason messages can be checked using the Pickup Messages button found on the Inseason Message screen (Figure 18-73). Click on Pickup Messages and ATLAS will open a connection and retrieve any incoming inseason messages. This button will NOT transmit outbound messages or data. Inseason messages are also received after preparing and transmitting data and after using the Transmit Messages Now button.

Broadcast Messages

To view and read generic broadcast messages that have been sent to all deployed observers, go to ATLAS main screen (Figure 18-6), and in the center of the screen you will find the broadcast message. If there are no current broadcast messages the text will state “Currently no broadcast message”.

TRANSMITTING DATA

Vessels equipped with ATLAS have the capability to transmit observer data directly to the Observer Program Seattle office. Data are transmitted from inside of ATLAS via a satellite phone or broadband connection on the vessel. Shoreside plant ATLAS data are transmitted from inside ATLAS over the plant’s broadband network. Observers deployed in the Partial Coverage sector will be using a wireless signal to send data over a wireless signal.

Before you transmit data from a vessel, confirm with vessel personnel that the onboard satellite phone has a strong enough signal to transmit data. If you are using a wireless signal to send data, make sure that the computer you are using has an open wireless connection and can connect to the internet. To transmit observer data, click on the Prepare & Transmit button from the ATLAS Main Menu (Figure 18-6). The Prepare & Transmit screen will open (Figure 18-74).

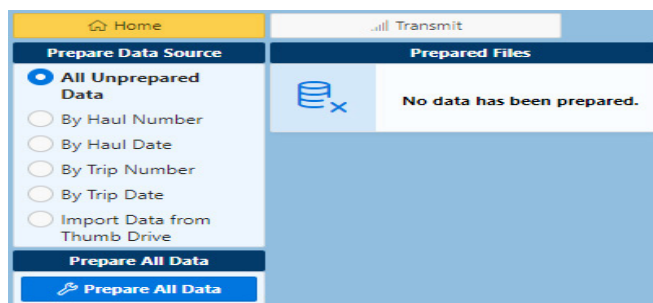

Figure 18-74: Prepare & Transmit Data Screen

Observers are required to transmit data via ATLAS once per day. If you are deployed on a vessel that does not have at sea transmission capabilities, you are required to send data once your vessel returns to port after every trip.

In all sectors it is important to note that you must transmit complete data only. Transmitting incomplete data (e.g., haul information without the associated species composition data) can affect how the data are being extrapolated.

Specifics on Transmitting Data

Once the Prepare & Transmit screen form has opened, you must first select from the Prepare Data Source list which data to prepare (Figure 18-75). The default option is All Unprepared Data and should not be changed unless instructed to do so by Observer Program staff.

After selecting the prepare data source then click on the Prepare All Data button.

Your data will be prepared for transmission. During the preparation process, the data you have selected is pulled out of the database and compressed into a file that will eventually be transmitted to Seattle. When the data preparation is finished, you will receive a message that your data have been prepared. For partial coverage observers, when you click on the Prepare Data button, all data for all vessels that have not been previously prepared will be prepared for transmission.

| Prepare Options | Prepare Functions |
|---------------------|--|
| All Unprepared Data | This is the default option. <i>You should always use this option unless otherwise instructed by your inseason advisor or other observer program staff.</i> This will prepare all new and edited data and any new outgoing inseason messages. |
| By Haul Number | Allows user to input a range of haul numbers to send. Prepares those hauls, plus any new or edited data and outgoing inseason messages. Only use this option if instructed. |

| Prepare Options | Prepare Functions |
|--|---|
| By Haul Date | Allows user to input a range of haul dates to send. Prepares those hauls, plus any new or edited data and outgoing inseason messages. <i>Only use this option if instructed.</i> |
| By Trip Number | Allows user to input a range of trip numbers to send. Prepares those trips, plus any new or edited data and outgoing inseason messages. <i>Only use this option if instructed.</i> |
| By Trip Date | Allows user to input a range of trip dates to send . Prepares those trips, plus any new or edited data and outgoing inseason messages. Only use this option if instructed. |
| By Offload Number. <i>Only appears for plant observers.</i> | Allows user to input a range of offload numbers to send . Prepares those offloads, plus any new or edited data and outgoing inseason messages. <i>Only use this option if instructed.</i> |
| By Offload Date. <i>Only appears for plant observers.</i> | Allows user to input a date range of offloads to send. Prepares those offloads, plus any new or edited data and outgoing inseason messages. <i>Only use this option if instructed.</i> |

Figure 18-75: Prepare Data Source Options

Data Transmission

After the data preparation has finished, you may transmit the data to Seattle. Select the Transmit button at the top of the Prepare and Transmit screen (the transmit button will be grayed out and will not become available until you have prepared data). ATLAS will find and open a connection to transmit the data to Seattle. Once the connection has been opened and the transmission process starts you will see a spinning wheel in the middle of the form. After your prepared outbound data are sent, the system will check for incoming inseason messages. A dialog box will notify you of a successful transmission

ATLAS INSTRUCTIONS: TRANSMITTING DATA

that includes the number of files transmitted and the number of incoming messages received.

You must monitor the transmission to make sure it is completed. Once the transmission is complete, you will receive confirmation if the transmission was successful or not. If you receive some type of error during the transmission verify with the vessel or plant that you have a valid internet connection and then click on the Transmit button again. Most transmissions only take a few minutes. If the transmission does not complete within 10 minutes, then close out of the Prepare & transmit Screen and try again.

Entering and Transmitting Data Using an USB Flash Drive

There are some instances where you will be assigned to a full-coverage catcher vessel that will not have the ability to transmit ATLAS data from sea. If this is the case, all data must be sent from a plant computer that has ATLAS or from the NMFS field office. To do this you must enter your data into the vessel computer, prepare the data to a USB thumb drive, and then transmit the data from the plant computer or NMFS field office. The following sections provide detailed, step-by-step instructions. If you are unable to send your data from a plant computer or NMFS field office, contact NMFS for instructions; see "Contact Addresses" on page A-61.

Data Entry on Vessel

1. Start the ATLAS Software.
2. Create a New User.
3. Login.
4. Click the Select Assignment Button. Enter the Permit or the Name or ADF&G number of the vessel you are on and click the Filter button. Click the Select button in that row. Then click on the Confirm Assignment button.
5. Now you can enter your data.
6. You must only use one USB drive per vessel.

Getting Prepared Data to a USB/Thumb Drive

1. Once you are done with data entry or data editing click on the Prepare & Transmit button from the ATLAS Main Menu.

2. Make sure that All Unprepared Data is selected then click on the Prepare All Data button.
3. Insert your USB/Thumb Drive into the computer (**DO NOT USE THE SAME USB/THUMB DRIVE YOU ARE USING FOR BACKING UP**)
4. In the list of Prepared Files, find the row that has the prepared file you just prepared.
5. In the Download column click on the Download button.
6. A Windows dialog Save As box will appear.
7. On the left hand side of the Save As box, find the USB/Removable thumb drive and double click on that drive.
8. Then click the Save button in the Save As box. The backup will now be saved to the USB/Removable thumb drive. The Save As dialog box will automatically close after selecting the Save button.
9. Take your USB flash drive to the plant and follow the directions listed under "Transmitting Data from a USB Flash Drive".

Transmitting Data from a USB Flash Drive

A NMFS field agent may handle the transmission if you take your data to the NMFS office. From the plant computer that has ATLAS do the following:

1. Start ATLAS on plant computer.
2. Click on Transmit from USB.
3. Insert the USB flash drive that has the data from the catcher vessel.
4. *Wait at least 20 - 30 seconds for your computer to recognize the USB flash drive.*
5. Click on the Folder Icon next to Choose file .
6. A new window will appear. On the left hand side of the screen find the USB/Thumb drive.
7. Double click on the USB/Thumb drive and on the right hand side of the screen find the file/folder that has the data from the catcher vessel and double click on that file.
8. Click on the Import button.

- Now click on the Transmit button to transmit the data to Seattle.

BACKUP/ARCHIVE

To open the Backup/Archive screen, select the Backup/Archive Navigation button from the ATLAS Main Menu (Figure 18-6). The Backup/Archive screen will open (Figure 18-76).

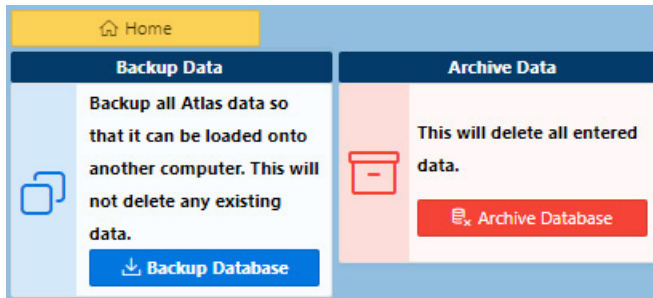

Figure 18-76: Backup/Archive Screen

Specifics on the Backup/Archive Screen

Before deploying, each observer should have received at least two USB/Thumb drives. These drives are to be used to perform daily backups on the computer with ATLAS. At the end of your cruise, just before disembarking for the last time, full coverage observers must perform an archive of the database. Observers deployed in the Partial Coverage sector do not archive. When you return for the debriefing process, you must have your USB/Thumb drives with you. The USB/Thumb drives should not be used for personal use and should not be used in your personal computers.

Backing up the ATLAS Database

Backing up the database must be performed on a daily basis. Typically this occurs after you have finished entering and transmitting data for the day. Insert your NMFS issued thumb drive into a USB port on the computer then click the Backup Database button. A Windows dialog Save As box will appear. On the left hand side of the Save As box, find the USB/Removable thumb drive and double click on that drive. Then click the Save button in the Save As box. The backup will now be saved to the USB/Removable thumb drive. The Save As dialog box will automatically close after selecting the Save button. *Never rename the backup file, doing so will prevent the file from being used to restore your data!*

Archiving the ATLAS Database

Archiving the database must be performed just before the sole or lead observer disembarks a Full Coverage sector vessel or plant for the last time. Archiving will delete all your data from the database so that the next observer will have a fresh database with which to work. *If you are the second observer and are disembarking you should not archive the database.* If you are on a Partial Coverage sector deployment and are returning for debriefing you should not archive the database.

Before archiving, make sure you do one last backup. Once you are ready to archive then click on the Archive Database button. A message will appear that you need to carefully read. Click on the OK button to Archive. Once the Archive is complete you will be logged out of Atlas and your data will have been deleted including your login user information.

EXPORT DATA FOR VESSEL

The export data for vessel feature allows the observer to export their data to the computer for the vessel to use. Vessel personnel may ask the observer to export their data. Providing data are a courtesy that is recommended but not required. Contact your inseason adviser or NMFS if you have questions or if you feel pressured by vessel personnel to provide data more than once per day. See “Providing Data to the Vessel” on page 2-8 for more information.

To open the Export Data for Vessel Screen, select the Export Data for Vessel Navigation button from the ATLAS Main Menu (Figure 18-6). The Export screen will open (Figure 18-77).

Exporting ATLAS Data

In the Data Export box, select the haul range of data you want to export. After selecting the haul range to export, select each form type to export by clicking the box next to each form type. Then select the Download Data button. The downloaded data will appear as a file at the bottom of the screen. Right click on the file at the bottom of the screen and select Show in folder. A new window will appear showing the file. You can now move that file to the place where the vessel would like you to move it to. Inseason messages will not be copied using the copy option. Once you have given the exported data to the vessel that is where your responsibility ends. What they do with the data or decisions they make based on

this data is not the responsibility of the observers. If you receive any questions or issues regarding your data, please alert your inseason advisor or other observer program staff.

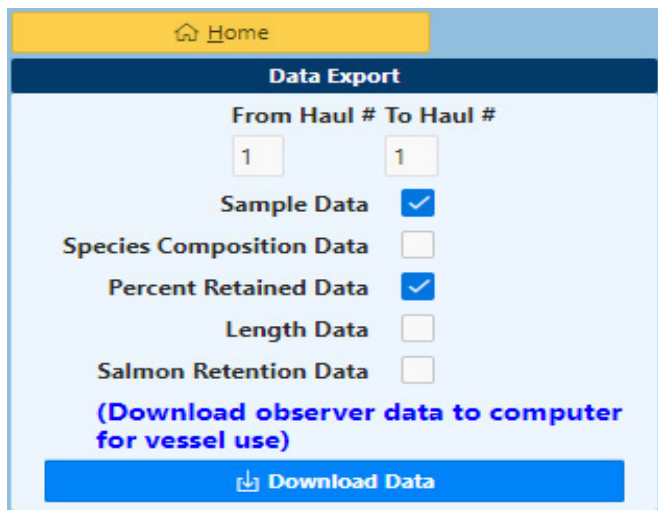

Figure 18-77: Export Data For Vessel Screen

REPORTS

The reports form allows users to view entered data in a quick readable format. To access the reports click on the Reports button found under the Atlas utilities section on the main screen of Atlas. Once in the report form you can view reports for the following data: Trip, Haul (VHF and OHF), Species Composition, Length and Specimen and Halibut Deck Sort data. Each report type can be viewed by clicking on the button with the name of the data you want to view. When a report opens it will open in a second tab. Using this new tab you can quickly compare your paper data to what is entered into Atlas.

IMPORTANT REMINDER – These data are confidential and should not be printed.

ATLAS FAQ'S AND BASIC TROUBLESHOOTING

Q1. What do I do if the ATLAS computer crashes, or the ATLAS software will not run?

A1. Contact NMFS IT staff (see “Contact Addresses” on page A-61). They will help you load your backup files from the thumb drive onto the backup ATLAS computer or a new computer. Do not switch to a backup computer without first contacting NMFS IT staff and restoring your data from the thumb drive!

In the meantime, continue sampling normally. Do not switch to paper forms.

Q2. What do I do if the on-board satellite communications go down, and I can enter ATLAS data but I can't transmit?

A2. Contact NMFS IT staff. They will work with you and the vessel/plant personnel to troubleshoot the communications issue. In the meantime, continue sampling and entering data into ATLAS normally. Do not switch to paper forms.

Q3. I am getting error messages when I transmit. Is my data going through?

A3. It depends. There are different types of error messages you might receive. If you receive any type of https: error it's most likely a signal issue on the vessel or plant. Generally these messages occur when there is a poor satellite signal and the transmission gets interrupted midway through. Ask the captain to let you know when the satellite has a good signal. Be patient and keep trying. If you have done all of this and you still cannot get through, contact NMFS IT staff for assistance.

Q4. I logged in as New User at the beginning of my contract, but I am getting an error that the password already exists What do I do?

A4. Use a different password than the one you are currently trying.

Q5. I have not heard from my inseason advisor. Help!

A5-1. From the Atlas Main Menu click on Inseason Message and then click on Pickup Message (make sure you have a signal). See if you get any messages from your inseason advisor.

A5-2. Send an inseason message with the wording “please direct to my inseason advisor.” There may be an issue with the way your messages are being routed on our end that we can resolve.

Check the inseason message form in your other vessels because you may have accidentally entered an outgoing message into a different vessel, so it was never sent. Copy any of these you find into your dummy text message vessel and re-send.

Q6. I lost some data and I need to restore my data from a thumb drive.

A6. Contact NMFS IT staff for assistance with restoring from a thumb drive. See Q1 for more details.

Q7. I'm assigned to a vessel in the Central GOA Rockfish program and I can't transmit. Help!

A7. Review the instructions on page 18-28 of this manual for how to transmit data to and from a USB thumb drive. If there is no working plant computer available, contact NMFS field staff in Kodiak for assistance. If this is not possible, contact NMFS IT staff. Let your employer know immediately if you are unable to transmit data successfully after any RF trip.

Q8. I was assigned to a vessel in the Central GOA Rockfish program awhile ago. I disembarked and now I am re-embarking the same vessel on the same cruise. What do I do?

A8. If you were given the same computer you had previously, try logging into ATLAS as current user using the same password you had previously. If all your data appears, continue entering data where you left off. If you are given a different computer than you had the previous time, or if you archived your data after disembarking then your data will need to be restored before you enter any new data. Contact NMFS IT staff for assistance.

Q9. I forgot my password and can't login to ATLAS. Help!

A9. Contact NMFS IT staff for assistance.

Q10. I'm a second observer and am disembarking the vessel. Should I archive the data?

A10. No. The lead observer is responsible for archiving the data.

Q11. I'm the lead or sole observer and am disembarking the vessel. Should I archive the data?

A11. It depends. See the following:

- If you are a Partial Coverage Observer, do not archive.
- If you are unsure if you will actually disembark or not, do not archive.
- If there is a good chance you may re-embark the vessel at a later point, do not archive.

- If you are positive you are disembarking for the last time (e.g. you are flying to Seattle to debrief), go ahead and archive.

Q12. I'm a full coverage observer, and I am getting back on a vessel I was already assigned to on this contract. What do I do?

A12. Do not enter any data into ATLAS without contacting NMFS IT staff first (see page A-61). They will help you restore your data from the thumb drive. Once the data are restored, continue where you left off in ATLAS with trip numbers, haul numbers, etc.

This page intentionally left blank

HEALTH AND SAFETY INFORMATION



Table of Contents

| | |
|--|-------|
| Priorities | 19-1 |
| Introduction | 19-1 |
| Vessel Safety | 19-2 |
| Vessel Safety Checklist | 19-2 |
| Completion of the vessel Safety Checklist and Safety Orientation | 19-3 |
| Example of completed Vessel Safety Checklist | 19-4 |
| Emergency Drills and Date(s) Conducted | 19-7 |
| Embarking, Disembarking and Transferring Between Vessels | 19-7 |
| Personal Health and Safety | 19-8 |
| General Safety Precautions | 19-8 |
| Working on Decks | 19-9 |
| Working in Factories | 19-9 |
| Seasickness | 19-10 |
| Fish and Mammal Poisoning | 19-11 |
| Fatigue | 19-11 |
| Illnesses and Accidents | 19-11 |
| The Seven Steps to Survival | 19-12 |
| Emergencies Onboard | 19-12 |
| Marine Casualties | 19-12 |
| Man Overboard | 19-13 |
| Cold-Water Near Drowning | 19-13 |
| Fire | 19-13 |
| Flooding | 19-13 |
| Abandon Ship | 19-13 |
| Sending a May Day | 19-13 |
| Safety Equipment | 19-14 |
| Immersion Suites | 19-14 |
| Life Rafts | 19-15 |
| EPIRBs | 19-16 |
| Personal Locator Beacons, PLBs | 19-16 |
| Personal Survival Kits | 19-17 |
| Summary | 19-17 |

PRIORITIES

Your own safety is *always your top priority*. In this chapter, you will find information on:

- how to familiarize yourself with safety equipment and procedures aboard commercial vessels.
- general safety precautions to take onboard and while you are performing your observer duties.
- how to deal with illness and sickness onboard.
- how to transfer between vessels safely.
- how to respond to emergency situations.
- what procedures to follow if you must abandon ship.

INTRODUCTION

Commercial fishing has ranked among “the most deadly occupations” in the United States since 1992, when the Bureau of Labor Statistics began publishing these data. Each year in Alaskan waters, an average of 34 fishing vessels and 24 lives are lost in the commercial fishing industry. Injury rates aboard commercial fishing vessels are also high. Slippery decks, heavy gear, and an inhospitable environment contribute to the hazardous working conditions.

The safety and survival material presented here and in observer training is only an introduction to these topics. There are many pamphlets, books, and videos that provide more detailed information about safety at sea, including *Federal Requirements for Commercial Fishing*

Industry Vessels, the North Pacific Fishing Vessel Owners Association *Vessel Safety Manual*, and the University of Alaska’s Marine Advisory Bulletin *Beating the Odds on the North Pacific*. All are available commercially and are carried aboard many vessels.

Safety is a personal responsibility. The safety equipment a vessel is required to carry is dependent upon the vessels size, number of crew and area of operations. You must be aware and knowledgeable of these variations in required safety equipment and procedures. Contact the Observer Program or your provider if you have questions.

Take every opportunity to learn as much as you can before an emergency occurs. Most fishing vessels are operated by safety-minded captains who realize the danger of their occupation, and consider safety in all they do. Use the knowledge and experience of the vessel’s crew for guidance with safety on your vessel. They are concerned about the safety of observers, as guests on their vessel, and will make sure that dangers for you are minimized. No matter how cautious the crew is, it is your responsibility to keep yourself safe and know how to react in all emergency situations.

VESSEL SAFETY

In mid 1998, NMFS adopted regulations to ensure the adequacy and safety of fishing vessels carrying observers. Under 50 CFR Part 600, owners and operators of fishing vessels that carry observers are required to comply with U.S. Coast Guard safety regulations. A vessel is considered inadequate or unsafe if it does not comply with the regulations regarding observer accommodations or if it has not passed a USCG safety examination or inspection.

This rule applies to all vessels designated to carry an observer as part of any mandatory or voluntary Observer Program under the MSFCMA (Magnuson- Stevens Fisheries Conservation and Management Act), the Marine Mammal Protection Act, or any other U.S. law.

Vessel Safety Checklist

Upon boarding a vessel for the first time, you must complete the “Vessel Safety Checklist” form in your logbook (Figure 19-1 on page 19-4) to ensure the vessel is in compliance with U.S. Coast Guard safety regulations. If you are reboarding the vessel after being deployed to another, you are expected to review the safety equipment again to ensure there were no changes to the equipment in your absence.

Locate the U.S. Coast Guard Commercial Fishing Vessel Safety Examination Decal. You must ensure the decal is valid for every vessel based on the information noted on the face of the decal. *If the vessel does not have a current Safety Examination Decal, you may not remain onboard.* Inform the captain that you are not able to stay onboard this vessel and immediately contact your employer and NMFS.

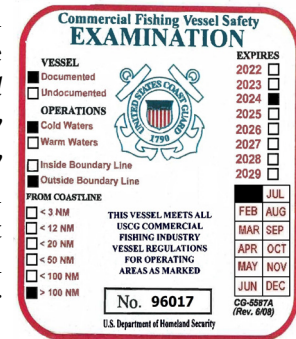

Document both valid and invalid decal information in your logbook. All items on the Vessel Safety Checklist must be addressed. Remember that all “N” responses on the checklist require a comment in the “additional comments” section. Items in bold blue text on the Vessel Safety Checklist are considered “no go” items. *If you circle “N” for any of the “no go” items, you may not remain on board the vessel.* In addition, if you feel that you should not remain on board the vessel, document in detail the reasons why and contact your employer immediately. Your NMFS issued camera may be used to capture any safety deficiencies you might find while completing the Safety Checklist. Deficiencies to be captured with your NMFS camera may include, but are not limited to, inoperable water tight doors, a questionable float free location for a liferaft or EPIRB, and incorrectly installed hydrostatic release mechanisms. NMFS will require that the vessel pass a USCG safety examination and correct the deficiency that is causing it to be out of compliance.

Observer Personal Protective Equipment

Your NMFS issued immersion suit with strobe light, PLB, and type 3 PFD with strobe light, are listed on the Vessel Safety Checklist as “no go” items. It is imperative that you have these items with you onboard the vessel when completing the Vessel Safety Checklist. If you do not have these items, contact your employer and NMFS staff immediately.

FIRST DAYS ONBOARD

When you board a vessel, regulations mandate that you receive a safety orientation. This may be as simple as crew members showing you around, but may include watching videos, donning immersion suits, or conducting drills. In addition to the required orientation, drills and instruction

must be conducted involving each individual *at least once every calendar month*. You should participate in any drills and instruction. For information on recording safety drills in your logbook see “Emergency Drills and Date(s) Conducted” on page 19-7.

COMPLETION OF THE VESSEL SAFETY CHECKLIST AND SAFETY ORIENTATION

Please reference the Federal Requirements for Commercial Fishing Industry Vessels pamphlet for more specific information.

1. Check for safety inspection documentation. Is the decal valid? Look for a current USCG Commercial Fishing Vessel Safety Examination decal or ask for documentation. Record the authorization number in the space provided. Pay particular attention to the areas of operation on the decal to ensure proper safety equipment as listed in the *Federal Requirements for Commercial Fishing Industry Vessels*. The decal expires on the last day of the month indicated by the hole punch in the month field. *You cannot remain onboard a vessel with an expired decal or if the decal will expire while you are aboard. Contact your employer and NMFS immediately if the vessel does not have a valid decal!*
2. Locate the life raft(s), if required. Is there enough life raft capacity for everyone aboard including you? Are you assigned to a particular one? Can the raft(s) float free? Check the service due date(s) displayed on the canister(s). Your vessel may be equipped with a rigid life boat (see “Rigid Life Boats” on page 19-16 for a description). Rigid life boats will not have a service due decal therefore you are not expected to complete this no-go item on your safety checklist. Note in the comments of the safety checklist that the vessel had a rigid, non-serviceable life boat. Check the hydrostatic release. Is it installed correctly? Has it expired? The expiration date is at the end of the month displayed. If the raft does not have a hydrostatic release and is rigged in an alternative float free manner, is it equipped with a weak link? Please ask the captain or crew if you have any concerns regarding the rigging of the raft or the hydrostatic release. Some small vessels may not be required to have a life raft onboard, but will have other survival craft requirements outlined in the *Federal Requirements for Commercial Fishing Industry Vessels*.
3. Where are the Emergency Position Indicating Radio Beacon(s) (EPIRB)? Are they mounted in a USCG approved manner? Check to see if the battery is expired. A sticker with the expiration date displayed will be located either on the actual EPIRB or the protective casing of the EPIRB. Are the hydrostatic releases expired? The expiration date is at the end of the month displayed. Check the NOAA registration sticker. This sticker is required of each vessel/EPIRB. Make sure it is registered to the vessel as the name will be noted on the sticker. Make sure the alphanumeric code on the actual sticker matches the registration code on the EPIRB. Check the expiration date on the sticker. The EPIRB tests must be recorded in a station log. Please ask the captain to see the log for the most recent test if one was not conducted for you. Note: Vessels required to have a category 2 EPIRB are not required to mount it in a float free location. *If a vessel only operates within 3nm from shore (as noted on the safety decal) they are not required to have an EPIRB.*
4. Check the location of immersion suits and PFDs. Where are the immersion suits and PFDs located? Are there enough for everyone aboard? Are they accessible at all times? Are the sizes appropriate for the crew? You will be issued an immersion suit with strobe light and a PFD with strobe light as part of your NMFS sampling gear. You must have your NMFS issued immersion suit with strobe light and a PFD with strobe light before embarking on a vessel. NMFS immersion suits are pressure tested per the manufacturer’s recommendations. Therefore, we are certain your NMFS suit has been inspected and tested on a regular basis; we cannot extend this certainty to non-NMFS immersion suits. Keep your suit where you can get to it quickly. Take this opportunity to try your suit on again and check the zipper. Could you put the suit on in 60 seconds? Does the zipper need to be waxed?

Vessel Safety Checklist

VESEL NAME: Miss Blue VESSEL PERMIT: 5591 VESSEL LENGTH EST.: 107

Ensure the USCG Commercial Fishing Vessel Safety decal is not expired. The expiration date is at the end of the month displayed.

Commercial Fishing Vessel Safety EXAMINATION

| | | | |
|---|---|---------|-------------------------------------|
| <input checked="" type="checkbox"/> Documented |  | EXPIRES | <input type="checkbox"/> |
| <input type="checkbox"/> Undocumented | | 2022 | <input type="checkbox"/> |
| <input checked="" type="checkbox"/> Cold Waters | | 2023 | <input type="checkbox"/> |
| <input checked="" type="checkbox"/> Warm Waters | | 2024 | <input checked="" type="checkbox"/> |
| <input type="checkbox"/> Inside Boundary Line | | 2025 | <input type="checkbox"/> |
| <input type="checkbox"/> Outside Boundary Line | | 2026 | <input type="checkbox"/> |
| | | 2027 | <input type="checkbox"/> |
| | | 2028 | <input type="checkbox"/> |
| | | 2029 | <input type="checkbox"/> |

THIS VESSEL MEETS ALL USCG COMMERCIAL FISHING INDUSTRY VESSEL REGULATIONS FOR OPERATING AREAS AS MARKED

No. 96017

U.S. Department of Homeland Security

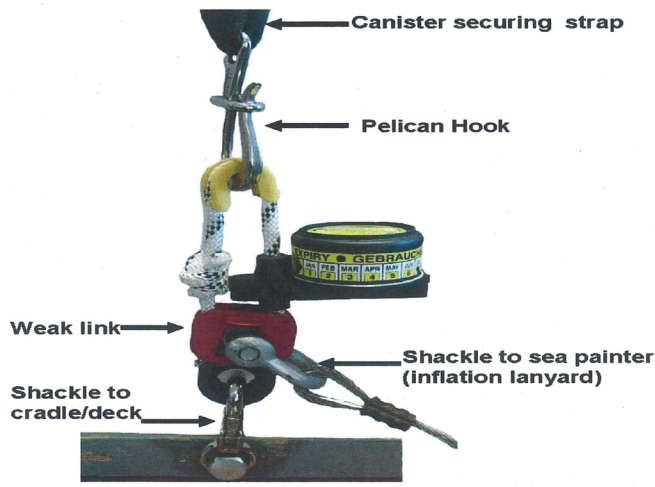

Some rafts are stored in a float free cradle - this is an approved cradling system, as long as the painter line is properly attached to a weak link.

| | |
|---|---|
| <p>Is the decal valid? (Y) N</p> <p>SURVIVAL CRAFT: Pg 6-9</p> <p>Number of: <u>1</u></p> <p>Total capacity: <u>8</u></p> <p># of crew & observer/s on board <u>7</u></p> <p>Sufficient capacity? (Y) N</p> <p>Survival craft(s) stowed correctly? (Y) N</p> <p style="font-size: small;">Float free or otherwise in accordance with the Federal Requirements for Commercial Fishing Industry Vessels (page 13)</p> <p>Service Due decal exp. date: <u>2</u> / <u>2024</u> (expires at end of month displayed- inflatables only)</p> <p>Hydrostatic release exp. date: <u>2</u> / <u>2024</u> (expires at end of month displayed)</p> <p>Your survival craft assignment: <u>1</u></p> <p style="font-size: x-small;">Enter information for all additional survival craft in the comments section.</p> | <p>Is hydrostatic release installed correctly? (Y) N</p> <p>EPIRB * (When Required): Pg 12-13 (Y) N</p> <p>Location(s): <u>Backside of wheelhouse</u></p> <p>Battery exp. date: <u>12/2024</u> (expires at end of month displayed)</p> <p>Hydrostatic release expiration date (cat. 1 only): <u>12</u> / <u>2024</u> (expires at end of month displayed)</p> <p>Located in a Coast Guard approved location? (Y) N</p> <p>NOAA Registration Valid? (Y) N</p> <p>Exp. date: <u>10/2024</u> (Unless otherwise noted, expires at end of month displayed)</p> <p>Registered to this vessel (name of vessel displayed): (Y) N</p> <p>Alphanumeric code on decal matches code on EPIRB: (Y) N</p> <p>Signal tested (or asked to see station log in wheelhouse for most recent test. Signal should be tested monthly): (Y) N</p> <p style="font-size: x-small;">*Visual inspection of EPIRB only. Leave all testing/handling to crew</p> |
| <p>IMMERSION SUIT/PFDS: Pg 3-4</p> <p>Available for everyone on board? (Y) N</p> <p>Location(s): <u>Storage Cabinet + in Wheelhouse</u></p> | <p>FIRE EXTINGUISHERS: Pg 14-16</p> <p>Extinguisher(s) found in every main area/corridor? (Y) N</p> <p>Extinguishers in "good and serviceable condition" (gauge in the green, low amounts of rust, canister in good condition, unobstructed, hoses attached, service tags available)? (Y) N</p> |
| <p>DISTRESS SIGNALS: Pg 11</p> <p>(ask captain for assistance)</p> <p># of distress signals meet federals requirements (Y) N</p> <p>Location(s): <u>Box in Wheelhouse</u></p> <p>All distress signals within expiration date (expires on date displayed) (Y) N</p> | <p>THROWABLE FLOTATION DEVICES: Pg 5</p> <p>Number of flotation devices appropriate for vessel size? (Y) N</p> <p>Number of: Rings <u>4</u> / Slings <u>1</u></p> <p>Easily accessible? (Y) N</p> <p>Name of vessel displayed on each? (Y) N</p> <p>Location(s): <u>1 bow, 2 stern, 2 wheelhouse</u></p> |

Figure 19-1: Example of completed Vessel Safety Checklist

| | |
|---|--|
| <p>ADDITIONAL SAFETY CHECKS:</p> <p>Watertight doors (when required)- do they close properly? <input checked="" type="radio"/> Y <input type="radio"/> N</p> <p>Hatches/passageways - are they unobstructed? <input checked="" type="radio"/> Y <input type="radio"/> N</p> <p>Discussed safe places to work on deck and in factory with captain/crew? <input checked="" type="radio"/> Y <input type="radio"/> N</p> <p>Discussed refrigerant leak procedures? <input checked="" type="radio"/> Y <input type="radio"/> N</p> <p>Type of refrigerant used (Freon or Ammonia) <u>Freon</u></p> <p>Identified person to discuss reporting marine casualties or inoperative alarms? <input checked="" type="radio"/> Y <input type="radio"/> N</p> <p>Did you hear the general alarm? <input checked="" type="radio"/> Y <input type="radio"/> N</p> <p>Where will you go during emergencies? <u>wheel house</u></p> <p>Will the vessel maintain watch at all times while under way? <input checked="" type="radio"/> Y <input type="radio"/> N</p> <p>If no, inform the captain, your contractor, and FMA. Do not remain on the vessel</p> | <p>FIRST AID MATERIALS: Pg 26</p> <p>Location(s): <u>wheel house</u></p> <p>Is there an individual trained in CPR/First Aid on board? <input checked="" type="radio"/> Y <input type="radio"/> N</p> <p>Who?: <u>Captain J. Smith</u></p> <hr/> <p>Communication Equipment: Pg 22-23</p> <p>How many SSB and VHF radios?: <u>2</u> / <u>2</u></p> <p>Are emergency call instructions posted? <input checked="" type="radio"/> Y <input type="radio"/> N</p> <p>Were procedures for making an emergency call discussed? <input checked="" type="radio"/> Y <input type="radio"/> N</p> <hr/> <p>Additional Communication Equipment</p> <p>List any additional communication systems on board in comment section (satellite phone, inReach, etc.)</p> <hr/> <p>STATION BILL: Pg 24</p> <p>Did you review the information on the Station Bill? <input checked="" type="radio"/> Y <input type="radio"/> N</p> <p>Describe your duties outlined in the station bill: <u>MOB - spotter Fire, Flooding, Abandon ship: wheelhouse + assist as needed</u></p> |
| <p>SAFETY ORIENTATION: Pg 26</p> <p>Did you complete drills upon embarking the vessel? <input checked="" type="radio"/> Y <input type="radio"/> N</p> <p>Where all of the items in the safety checklist addressed during the safety orientation? <input checked="" type="radio"/> Y <input type="radio"/> N</p> <p>Did the vessel conduct a safety orientation? <input checked="" type="radio"/> Y <input type="radio"/> N</p> <p>Who gave the orientation? <u>J. Smith (captain)</u></p> <p>Detail what was covered below <u>Muster station Safe places to work. Engine Room</u></p> | <p>EMERGENCY DRILLS Pg 25</p> <p>AND DATE(S) CONDUCTED: Only list drills in this section if they are conducted while you are physically onboard the vessel.</p> <p>Fire <u>1/7/23</u></p> <p>Abandon Ship <u>1/7/23</u></p> <p>Man Overboard <u>1/7/21</u></p> <p>Vessel Flooding/stabilization <u>1/7/23</u></p> <p>General alarm activation <u>1/7/23</u></p> <p>Donning immersion suits <u>1/7/23</u></p> <p>Radio/visual distress signals <u>1/7/23</u></p> <p>Were the drills hands-on involving actual gear? <input checked="" type="radio"/> Y <input type="radio"/> N</p> <p>Did you participate in the drills? <input checked="" type="radio"/> Y <input type="radio"/> N</p> |
| <p>COMMENTS (ALL "N" RESPONSES REQUIRE A COMMENT):</p> <p><u>Before Boarding Vessel drills were done on 12/26/22 + the captain showed me the log.</u></p> <p><u>vessel has satellite phone</u></p> | <p>OBSERVER PERSONAL PROTECTIVE EQUIPMENT:</p> <p>Do you have the PLB that was issued to you? <input checked="" type="radio"/> Y <input type="radio"/> N</p> <p>PLB UIN: <u>2DCE577N14FFBFF</u></p> <p>Immersion Suit with Strobe Light and Battery? <input checked="" type="radio"/> Y <input type="radio"/> N</p> <p>Serial #: <u>969420</u></p> <p>Personal Flotation Device with Strobe Light and Battery? <input checked="" type="radio"/> Y <input type="radio"/> N</p> |
| <p>Observer Name: <u>J.J. Furstenfeld</u> Cruise #: <u>27572</u></p> <p>Observer Signature: <u>JJ Furstenfeld</u> Date: <u>1/3/23</u></p> <p>Captain Name: <u>John Smith</u></p> <p>Captain Signature (optional): _____ Date: _____</p> | |
| <p>Blue indicates "No Go" items!</p> | |

Figure 19-1: Example of completed Vessel Safety Checklist



It is your responsibility to make sure the safety decal and all the blue no-go items are in compliance for the entire time you are deployed on the vessel.

5. Where are the flares located? Check the expiration dates. What types of flares does the vessel have?
6. Locate the fire extinguishers. Are they accessible? Are they in good and serviceable condition? Check to see that the pressure gauge is in the green, there are low amounts of rust, that the overall condition of the canister is good, that it is in an unobstructed location with hoses attached, and that there is a presence of service tags (tags are not a USCG requirement). Did the crew tell you of special extinguishing systems in the engine room or other areas?
7. Check the location of life rings. Where are they? Are they accessible? Is there one on each side of the vessel? Are the lines free of tangles? Is the vessel name on the ring/sling?
8. Where do you go during emergencies? Find the station billet (commonly called the station "bill"), a posted placard describing the role of all hands onboard (including the observer) in an emergency. Familiarize yourself with your role in each type of emergency addressed. As you walk through the vessel, make yourself aware of potentially hazardous areas.
9. Identify the watertight doors (if required), both on the interior and the outside. Can they be secured in case of heavy weather or other emergencies? Are any hatches or passageways blocked or difficult to get to? Ask the crew giving you the orientation to point out doors that must be kept closed during travel, gear retrieval, rough weather or other situations.
10. Discuss safe places to work on deck and/or in the factory with the captain/crew and how to report/identify inoperative alarm/fire systems.
11. What type of refrigerant is the vessel using (ammonia or freon) and what do you do if there is a leak? For more information about Freon and Ammonia, see A-77 and A-78.
12. Did you hear the general alarm? Ask the captain to demonstrate the general alarm. Does the vessel use different signals for different emergencies? If so, what are they?
13. Will the vessel maintain watch at all times while underway? If you are informed by vessel personnel that they will not maintain watch at all times do not remain on the vessel and document and notify FMA and your employer. Vessels must maintain a proper lookout at all times. See "Safe Conditions" on page 20-12 of the Regulations section for more information.
14. Where are first aid materials kept? Is there a reference book onboard? Who in the crew has had first aid and CPR training?
15. Where are the SSB and VHF radios located? How many are there? Note that on rare occasions small vessels, typically in the partial coverage sector, without SSB radios may substitute a satellite phone for the SSB radio. Contact NMFS or your provider with any questions. Are emergency call instructions posted nearby? Do you know the procedures for making an emergency call and how to operate the radio during the call? If not, ask the captain to show you how!
16. Did the individual giving you the safety orientation use this safety checklist to complete the required vessel safety orientation? Who gave the orientation? You must be provided with a safety orientation and the following items need to be addressed along with the date(s) that each drill was conducted:
 - survival craft embarkation stations.
 - fire / emergency / abandon ship signals.
 - immersion suit locations and donning instructions.
 - procedures for making a distress call.
 - essential actions required of each person in an emergency.
 - procedures for rough weather at sea.
 - procedures for anchoring.
 - procedures for recovering a person overboard.
 - procedures for fighting a fire.

Never get under way on a vessel without first receiving a safety orientation. If the captain will not provide you with an orientation before leaving the dock you must

disembark the vessel. It is not appropriate to receive the orientation after departing.

17. The vessel may request a copy of the checklist. Please sign it and make a copy from your logbook. You must keep the original! If a copy machine is not available, either duplicate an original color version of the checklist onto a “black and white” version of the checklist and tear that out of the logbook or let the captain know a copy can be mailed to the company, owner, or vessel upon completion of your cruise. “Black and white” versions of the Safety Checklist may also be used in the event that you run out of color copies.

Maintaining Safety at Sea

Safety once under way is important. If you have concerns about your vessel’s at-sea operations, document the concerns and contact your inseason advisor or NMFS.

Maintaining a Proper Lookout

Vessels must maintain a proper lookout at all times while they are underway. If you observe that the vessel is not maintaining a proper lookout while at sea, discuss your concerns with the captain and inform your inseason advisor and provider.

EMERGENCY DRILLS AND DATE(S) CONDUCTED

Emergency drills and instruction must be conducted by the vessel *at least once every calendar month*. The actual dates the drills are conducted must be documented in your observer logbook in the pertinent section of the Vessel Safety Checklist. Document drills in the Vessel Safety Checklist *if and only if* these requirements are met:

- drills are hands on and involve actual gear.
- you are assigned to the vessel at the time of the drills.
- you participate in the drills being conducted.
- document any drills that are conducted but do not meet these criteria, *in your Daily Notes*.

You should participate in all drills; they are essential to keeping you prepared in the event of a real emergency. There may be a rare case where you cannot participate in or actively witness the drill activity due to safety concerns. In this situation, you most likely will be stationed at your

muster location as you would be in the case of an actual emergency (e.g., the wheelhouse). You can still record this drill as being conducted if you get information about it from vessel personnel who participated directly in the drill. The reasons why you could not participate in or witness the drill due to safety concerns must be documented in your Daily Notes.

EMBARKING, DISEMBARKING AND TRANSFERRING BETWEEN VESSELS

Wear a PFD at all times when on skiffs or other small vessels, while transferring between boats and when embarking or disembarking your vessel at the dock. When climbing, do not encumber yourself with heavy backpacks or baggage. Balance is important and both hands must be free during transfers. Use a day-pack and wear foot wear such as Xtra-Tuffs or athletic shoes that provide sure footing. Time your actions with the movement of the boat, starting your climb up a ladder from the top of the up-and-down cycle to avoid being pinched against the ladder by a moving boat. All baggage should be secured with lines and transferred via rope lines or cargo nets. Observer baskets and luggage have been lost overboard because they were thrown between ships without lines attached.

If you use a cargo net, transfer basket, or cage to board a vessel, make sure that a line is attached to the conveyance from both points for greater control and to reduce swinging. Maintain a crouched position to avoid back injury. Be sure to wear your hard hat in addition to your PFD when using this mode of transfer. Keep your arms, elbows, and fingers inside the conveyance when transferring.

Boarding Vessels at the Dock

It is the expectation of the observer program that you will wear a PFD anytime you embark or disembark a vessel. Many larger vessels provide a gangplank with a safety net for boarding. This is not often the case with smaller vessels. Dock space at plants and other docking areas is minimal. As a result there is not always room for every vessel to secure their lines to the dock. When this happens vessels will tie to other vessels that are secured to the dock; this is called rafting. It is common to see vessels rafted two or more deep at the plants or docking areas. *Boarding vessels that are tied to the dock or are rafted is extremely dangerous!* Falling between the dock and vessel, or between one vessel and another, can result

in serious injury or death. The distance between the vessel and the dock or between vessels that are rafted can vary widely with the weather, tides, and currents.

Ensure your safety when boarding vessels by:

- always wearing some type of personal flotation device when crossing between boats and the dock,
- always ensuring someone is around to watch you before attempting to cross. You should clearly communicate your intentions to dock personnel or other crew members and ask that they watch you until you are safely aboard your vessel or on the dock, and not boarding when it is not safe. Consider conditions such as icy and slippery decks and/or ladders, poor weather, darkness, wind, tides, currents and/or distances greater than you can safely manage.

Transfers at Sea

You will normally board and disembark vessels at the dock, but transfers at sea may sometimes be necessary. Transfers between vessels are potentially hazardous, especially in rough weather. You must assume responsibility for deciding whether or not to transfer based upon your own evaluation of the sea conditions, transfer vessel, visibility, and distance to travel.



Never transfer via a small boat if you cannot see your destination. Do not transfer at dusk, in darkness, or in any other low visibility conditions. If boarding a small skiff or inflatable boat, make sure that the engine has been started and warmed up, and that there are oars stowed as a backup. Do not transfer when the sea state is two meters or more. Always be cautious, you cannot be forced into transferring against your better judgment by an anxious or impatient captain. Under “Vessel Responsibilities,” 50 CFR §679.50(g), an operator of a vessel required to carry one or more observers must:

- Ensure that transfers of observers at sea via small boat or raft are carried out during daylight hours, under safe conditions, and with the agreement of observers

involved.

- Notify observers at least three hours before the transfer, provide a safe pilot ladder, and conduct the transfer while ensuring the safety of observers.
- Provide an experienced crew member to assist observers in the small boat or raft in which any transfer is made.

In some situations, observers will have to board vessels to transit between ports or other vessels. These vessels volunteer to transport observers and are not subject to observer coverage safety regulations. Regardless, your safety is your number one priority and the final decision to utilize this mode of transportation is ultimately yours. In these situations, you need to complete the Transport Vessel Float Plan and Safety Profile provided in your logbook to identify and familiarize yourself with safety equipment and emergency procedures while aboard these vessels. Your safety should always be your top priority and following the 7 steps of survival in every situation you encounter will ensure the proper emergency response at sea.

PERSONAL HEALTH AND SAFETY

Fishing vessels and processing plants have many potentially dangerous areas. Be aware of your surroundings at all times and keep your eyes and ears tuned to what is going on. Your work hours and environment will be different than what your body is accustomed to. Drinking plenty of water and eating enough food are critically important in maintaining your health in this new environment.

General Safety Precautions

Staying safe aboard a vessel includes more than safety equipment. Follow these guidelines to avoid injury and strain during your work activities:

- It is the expectation of the observer program that you will wear a personal flotation device whenever you are working on deck, transferring at sea, or disembarking or boarding your vessel.
- Never board or disembark a vessel alone! Always be sure someone is there to watch that you transfer safely on or off the vessel.
- Avoid loose clothing or apparel with strings. Remove

all jewelry prior to going out on deck or into the factory. Long hair should be tied back. These items could be caught in moving equipment.

- Don't run aboard ships, particularly up stairwells. Hold handrails in stairwells and on ladders. Slipping, tripping, and falling are the most common causes of observer injury. Keep one hand free at all times.
- Step carefully over the combing rising from the bottom of metal doors and passageways, and be aware of low overheads in vessel stairwells and on water tight doors.
- Memorize the exit route from your cabin, the factory, the galley, and other locations where you spend a fair amount of time. Keep your immersion suit where you can get to it quickly.
- Lift correctly! When lifting, get as close as possible to the object, keep your back straight, and use your legs. On a moving vessel, this is critical because unexpected movements can strain your back. Don't be afraid to ask for assistance in moving heavy objects, such as full baskets.
- Fatigue and sleep deprivation suffered by the crew and yourself are threats to your safety. Be aware of the physical state of those around you, whether the person is on watch or in control of the gear. Fatigued individuals make mistakes that could affect you. Monotonous work, such as longline tally sampling, is difficult to do accurately and safely when you are tired. Follow the example of the crew and catch up on sleep when there are breaks in fishing.
- Eat well. Vegetarians (due to common meat-and potato menus) and diabetics (due to odd eating schedules) need to be especially concerned with getting a proper diet. Dietary supplements or vitamins may be helpful if this is a concern for you.
- If you are not feeling well, use extra caution and reduce your time spent working.

Working on Decks

Wear a hard hat, safety glasses, personal flotation device and boots when on deck.



- Do not stay outside on the deck during rough seas. You could be swept forward over a

trawler's winches by waves sweeping up the stern ramp. When you are outside, remain in full view of a second party at all times.

- Watch for slick spots where the deck is wet, oily or frozen.
- Be aware of trawl cables under strain, they can give way and have maimed and killed fishermen. Whenever a cable is subjected to tension, stand where a backlash will not hit you. If your sampling station is on deck, stop working and go to a safe place while trawl nets are being set or retrieved.
- Explain to the deck boss that you need to watch the haul-back to monitor for marine mammals and will need to go out on deck for codend measurements once the winches have stopped. Ask for advice on a safe place to stand. When nets are being hoisted off the deck, stand clear. Heavy nets have fallen near observers when the suspending cables parted.
- Watch for moving pots and, if possible, face the pot launcher while you work. Stay away from the buoy line when the crew is launching pots. Crewmen have been caught in a loop, or the "bite," of the line and pulled over board.
- Wear eye protection on longliners if you are near the moving hooks. Use a gaff to collect fish to protect your hands and keep your body further away from the moving line. Know the location of the emergency stop switch for the hydraulic hauling block (if your vessel is equipped with one).

Working in Factories

Factory processing areas are crowded with machinery, electrical lines, and conveyor belts. The maze of equipment often makes it difficult to get to your sampling area. Climbing over, under and around machinery on oily and wet floors, especially in rough weather, is extremely hazardous. Look carefully before stepping or grabbing for hand holds.

You may be subjected to loud factory conditions for extended periods of time. Wear ear protection!

When collecting samples off conveyor belts, do not try to pry out fish caught between two connecting belts, or grab for fish caught under a diverter board. Your finger or hand may get mangled in the machinery. If you need

to retrieve these fish, make sure the belt is stopped first. Ask the crew to shut down the belts for you. In case of an emergency, know the location of the emergency shut off switch or stop button for the belts or hydraulics in your work area.

Whenever you are in the factory, be aware of factory offal wash out around the scuppers and bilges. This rushing water can affect your balance. Lastly, watch for low beams, belts, hoses, and other equipment; observers frequently hit their heads in unfamiliar factories.

Some factories have sanitation rules, including “foot dips” with cleaning solution and brushes, that observers must follow. The factory may require hair nets, beard nets and for all jewelry to be removed. Please be aware of these rules and be sure to follow them.

Seasickness

One of the least pleasant aspects of going to sea is the possibility of sea sickness. An individual’s susceptibility to seasickness is highly variable. If you’ve experienced motion sickness in cars, planes, or amusement park rides, you may experience seasickness during your cruise. Most people feel some level of discomfort when they first go to sea.



Seasickness results when the signals your brain receives from the inner ear balance mechanism contradicts what your eyes are seeing. For example, inside the cabin of a rocking boat, the inner ear detects changes in linear and angular acceleration as the body bobs with the boat. Since the cabin moves with the passenger, the eyes register a relatively stable scene. Agitated by this perceptual incongruity, the brain responds with stress-related hormones that can lead to headache, dizziness, nausea and vomiting. Its effect can be magnified by strong smells (like diesel fumes or fish, which are part of daily life at sea).

Seasickness usually occurs in the first 12-24 hours after sailing. For most people, seasickness dissipates when the body becomes acclimated to the ship’s motion (getting one’s “sea-legs”). In rare cases, an individual may stay ill beyond the first couple of days at sea, regardless of sea state. If this occurs, dehydration may become life threatening.

Take seasickness medication before you go to sea. There are several over-the-counter or prescription medications

available to minimize seasickness. Antihistamines such as Dramamine (generic name dimenhydrinate) or Bonine (generic name meclizine) are effective and are available over-the-counter. These drugs cause drowsiness. A two part, prescription-only drug called “Coast Guard cocktail” is Promethazine, a seasick-preventing antihistamine coupled with Pseudoephedrine, which prevents drowsiness. Transderm Scop is another prescription-only motion sickness drug. It is a dime-sized adhesive patch that is worn behind the ear and delivers a continuous dose of scopolamine. Each patch lasts for 72 hours. The main side effects of the patch are dry mouth and occasionally blurry vision, but there is less drowsiness. Acupressure wristbands and eating crystallized ginger are other remedies used with varying success.

Seasick medications must be taken before the symptoms begin. Most take several hours to be absorbed in your system and may not work if you are already vomiting. Even if you doubt you will get seasick, you might want to take the medication before you board as a precaution.

If you should get seasick, take comfort in the fact that recovery is only a matter of time. All that is usually required for a complete recovery is some patience. Here are a few tips and considerations regarding seasickness:

- Continue eating foods such as crackers, dry toast, dry cereal, etc. Avoid food that is greasy, sweet or difficult to digest. Keeping something in your stomach may suppress nausea and eliminate painful “dry heaves.”
- Keep drinking fluids. Seasickness and related medications cause dehydration and headaches. Drink low-acid juices, clear soups and water. Avoid citrus juices, milk and coffee.
- Focus on the horizon to eliminate the visual conflict in your brain. If you must be inside, try to stay toward the middle or aft of the vessel.
- Keep working. Most people find that being busy on deck keeps their minds off their temporary discomfort. Also, the fresh air on deck may help speed recovery.
- Carry a plastic bag. This simple trick allows some peace of mind and eliminates some of the panic of getting sick. If you vomit over the side of a boat, be aware of the direction of wind and waves. Going to the leeward side will ensure that an unpleasant experience doesn’t become any worse!

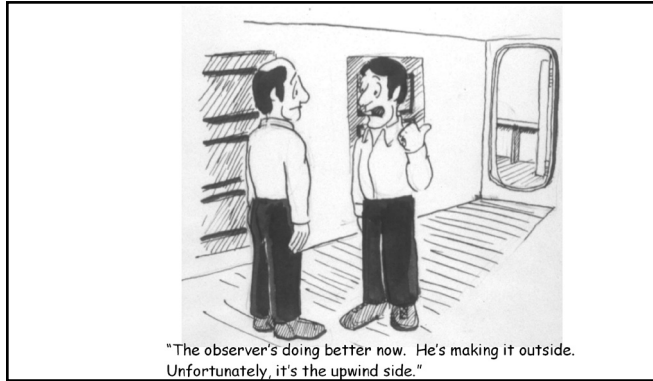

- Above all, don't be embarrassed or discouraged. If you are sick, chances are that others are sick too. No one is immune to seasickness.

Fish and Mammal Poisoning

Bacteria from fish may lead to infection in cuts, scrapes or punctures. To prevent this "fish poisoning," wash your hands thoroughly after sampling in hot, soapy water. Change your gloves often to keep them dry and discard any torn gloves. Treat all minor cuts, especially those on your hands, with an antiseptic such as Betadine to avoid infection from fish slime.

Wear safety glasses when working to keep slime, scales, and blood out of your eyes. Be cautious whenever wading through fish on deck or in the factory. Fish spines, especially on rockfish, can penetrate rubber boots and cause painful wounds to the feet.

If a wound becomes red or swollen, soak it for 1/2 hour in very hot, soapy water at least three times a day. Dry and bandage the wound. Antibiotics are commonly prescribed for fish poisoning. Vessels very often carry antibiotics onboard should they be needed. Never leave an infection untreated! The threat to your health can become much more serious than simply a pair of inoperative hands.

Take extra precautions against infection when collecting specimens from marine mammals. Because these mammals have similar biological systems to our own, organisms which infect them can infect us. "Seal finger" is a fungal infection of the hands which can easily be contracted by a scratch or bite.

Fatigue

Lack of sleep is as much a part of observing as observer baskets and rain gear. Sleep deprivation can cause serious

problems. When you are tired, you may become irritable and you are less likely to make good decisions or pay attention to hazards.

The only way to recover from sleep deprivation is to sleep uninterrupted for five to twelve hours. You may be able to get this amount of rest during offloads, weather days or while the vessel is steaming. During regular fishing operations, there are steps you can take to minimize the effects of sleep loss.

- Rotate your tasks. Try alternating weighing, measuring, tallying and doing paperwork. You are less likely to become bored and feel tired when doing a new task.
- Increase your physical activity. Just doing a few jumping jacks or push-ups helps increase circulation and oxygen intake which makes you feel more alert.
- Allow for at least four hours of uninterrupted sleep each day. Supplement this with power naps. These should be either 20 or 90 minutes in duration so as not to disrupt your REM sleep.
- Have a small carbohydrate snack, such as an apple, muffin or cereal. Proteins will give you sustained energy throughout the day, but may exacerbate drowsiness because it is harder to digest.
- Use caffeine sparingly. This stimulant may mask the symptoms of sleep deprivation, but may also inhibit you from napping or falling asleep at the end of your busy day.
- If possible, avoid antihistamines, motion sickness medication and other drugs that may sedate you.

ILLNESSES AND ACCIDENTS

If you have an illness or injury that prevents you from completing your assigned duties, you must inform NMFS and your contractor immediately. If communications are not readily available on your vessel or if you need immediate assistance, notify your captain. You are expected to provide daily updates to NMFS staff and your contractor regarding the status of your situation. If your condition does not improve and continues to affect your work, your assignment may need to be changed to protect your health and well being. By regulation, each vessel must have at least one person onboard certified in first aid and CPR. If you are hurt onboard, contact your employer and NMFS. If the accident is serious,

the captain will contact the USCG who will respond as necessary.

THE SEVEN STEPS TO SURVIVAL

The Seven Steps to Survival were assembled by the USCG from personal experiences of those who survived emergency situations. Committing the seven steps to survival to memory should be one of your goals in learning how to survive at sea. Every time your situation changes—boarding a raft, reaching land, etc.—the seven steps begin again.

1. Recognition

Quickly recognize the seriousness of the situation and that your life is in danger. Hesitation or denial may cost your life, especially in the harsh environment of Alaska.

2. Inventory

Stop and assess the situation. Decide what you have that will help you survive and what are the hindrances. Inventory equipment, weather, your skills, injuries, and your mental condition. Doing so will help you to make good decisions that will help you survive.

3. Shelter

Your biggest enemy in Alaska is the cold. Shelter can be clothing, an immersion suit, a raft, an overturned vessel or anything that protects you against the loss of your body heat. Water takes heat away from your body 25 times faster than air, so shelter should keep you as dry as possible. High heat loss areas, including the head and neck, need to be protected most. The added buoyancy of a PFD helps keep your head and neck out of water, therefore conserving heat. In a shore survival situation, the seven steps start over again and shelter is your first priority after you inventory the situation. It takes hours to construct adequate shelter on shore and you must do so as soon as possible.

4. Signals

A signal is anything that attracts attention and conveys a message. Radios, EPIRBs, and flares are signals carried by vessels. Immersion suits have lights attached. If abandoning ship, anything that can be tossed overboard may help an aircraft spot your position. *Anything that makes you bigger, brighter, or different from your surroundings creates a great signal, so attempt to gather items which float from a sinking ship.* In a shore survival

situation, three of anything (fires, buoys, immersions suits on the beach) is an internationally recognized distress signal.

5. Water

It is recommended that humans drink two liters of water per day to stay healthy. You can live without water for only a few days, and will suffer dehydration from the onset of any abandon ship emergency. Life rafts have limited rations of water, so it is advised to try to gather drinkable water before abandoning ship, if time permits. Have a strategy for gathering extra water in an emergency. Never drink sea water or urine.

6. Food

You can go without food much longer than without water. Never eat food without water! Your body requires water to digest food. Life rafts have limited food rations. In a shore survival situation, many types of edibles can be found near shore. Almost any animal or green plant in the intertidal zone are edible, but avoid mussels or clams, they may cause paralytic shellfish poisoning.

7. Play

Studies have shown that mental attitude makes a positive difference in a survival situation. Play is anything that keeps you occupied and prevents your mind from dwelling on the difficulties you are facing. Play could be reading, telling jokes or stories, completing a task, improving your shelter—anything that keeps your mind active and focused.

EMERGENCIES ONBOARD

Each person onboard plays an vital role in responding to emergencies at sea. The Vessel Safety Checklist, safety orientation, and participating in required drills should help prepare you for any emergencies which may occur.

Marine Casualties

The term marine casualty is used by the USCG to describe an accident involving a vessel or any person onboard a vessel.

All marine casualties must be reported to Observer Program staff immediately. They must be documented in your logbook and discussed inseason and during your debriefing interview. The following incidents are considered marine casualties:

- fire
- flooding
- man overboard (MOB)
- collision
- grounding
- loss of power
- loss of steering
- any crew injury beyond regular first aid
- gas leaks (ammonia and freon)
- lack of safety drills if onboard for an entire calendar month.

You are required to complete a written statement for each incident of a marine casualty. These written statements are usually prepared during final debriefing. The more details you have documented in your logbook, the easier completing these statements will be.

Man Overboard

Everyone has an active role in a man overboard emergency. If you witness someone falling over, you must both notify the person at the vessel controls and keep the victim in sight. According to the station bill, crew members are assigned specific tasks such as donning an immersion suit to be the rescue swimmer, launching a life boat, or throwing a life ring. As an extra set of eyes, the best role for you is to keep your eyes on and your arm pointing to the victim to aid the person at the controls.

Cold-Water Near Drowning

Cold-water near drowning is a phenomenon that has been observed in cold waters such as the seas surrounding Alaska. Although the victim may appear to be dead, victims have been revived using CPR even after being immersed in cold water for up to one hour. If you are involved in rescue or recovery effort, keep in mind that persons that have been in the water might be revived with treatment.

CPR is an exhaustive activity that requires more than one caregiver. You are not required to be certified to apply CPR to a victim. It has been said that bad CPR is better than no CPR. Keep in mind that although a victim looks dead, she/he may be revived by this technique.

Fire

A fire needs heat, fuel and oxygen. Remove any one of these components to stop a fire. Ships carry large quantities of fuel and offer few places to go in the event of fire. Station bills give specific duties responding to a fire onboard including who is in charge of the fire fighting team, and what equipment each person is responsible to gather. It is wise to know where fire extinguishers and exits are located in every area of the vessel, especially those areas in which you spend time. Fire extinguishers only have short bursts of fire retardants, so back-up extinguishers should be located and brought to the fire as soon as the fire is discovered. To effectively use a fire extinguisher, fire in short bursts in a low, sweeping motion. Keep your body low so as to avoid smoke inhalation and heat. Do not attempt to fight anything but the smallest fire (a wastebasket, for example) on your own; sound the alarm immediately before you take action. After a fire, a thorough inspection must be made of the area including adjacent walls and rooms, to be sure the fire did not spread and will not flare up again.

Flooding

When a vessel is taking on water the crew usually has time to try and solve the problem. Malfunctioning pumps or leaks in through hull fittings are not uncommon, and can usually be fixed with equipment onboard. If the flooding condition worsens, the Coast Guard can drop pumps to a vessel via aircraft. Observers have a limited role in these types of vessel emergencies but should be prepared to assist if needed.

Abandon Ship

The worst possible emergency requires you to give up your shelter—the vessel. Never abandon the ship unless you are sure that being onboard the vessel is more dangerous than being in the water. Lives have been lost because ships have been abandoned too soon during fires or flooding. Knowing the nearest exits, mustering areas, life raft locations, immersion suit locations, EPIRB locations, and the emergency equipment available become critical factors in helping you survive an abandon ship emergency.

SENDING A MAY DAY

A may day call is for a life threatening emergency. The emergency frequencies are VHF Channel 16 and 2182.0 kHz or 4125.0 kHz on single side band radios.

VHF radios are for short range and SSB radios are for long range communications (see Appendix Z for more information on radios). Vessels are required to monitor these emergency frequencies at all times. Most radios have a red button that changes to the emergency frequency immediately. Near the radios, there will be a placard posted that describes MAYDAY calls. Be familiar with what constitutes a proper MAYDAY call:

- MAYDAY (say three times)
- Vessel name (say three times)
- Location
- Nature of emergency
- How many persons onboard
- Vessel description
- What radio frequency is being used
- Release the mic
- Wait, then repeat

SAFETY EQUIPMENT

Personal Flotation Devices (PFDs)

No matter how careful you are, you cannot guarantee that you won't end up in the water. NMFS requires that all observers check out a PFD and additional strobe light during their gear issue. The Observer Program has several different versions of type III USCG approved PFDs to choose from to ensure a good fit. NMFS also has exposure coveralls available for use on longliners which offer additional insulation for long tally periods on deck and during the winter months.



The best PFD is the one you wear!

Consider purchasing your own PFD. Mustang, Stormy Seas, and other manufacturers make comfortable, versatile PFDs that are incorporated into rain gear, jackets, belts or vests. A strobe light is provided by the Observer Program and must be attached to your PFD. Let NMFS know your needs. The PFDs that NMFS provides can change based on your feedback!

Immersion Suits

Immersion suits (often called survival suits) have helped save hundreds of lives because they provide flotation and excellent hypothermia protection. The vessel to which you are assigned is required to carry an immersion suit for all persons aboard. You will be issued a suit by NMFS as part of your safety gear.

Try on your immersion suit in the presence of Observer Program staff prior to every cruise to verify proper fit! The Observer Program has several brands and sizes with enough options for you to find the very best fitting suit possible. When trying on your suit, wear normal work clothes that you will be wearing at sea. Proper fit and storage is vital for an immersion suit to protect you effectively. *In the event that Observer Program staff did not witness you don your NMFS issued immersion suit and PFD to verify fit before your deployment, you must complete the Immersion Suit & PFD Self-Check page in your logbook.* It is recommended that all observers complete the Immersion Suit & PFD Self-Check on a monthly basis and when switching vessels. If there are any problems/questions with your suit or PFD, inform the master of the vessel and contact the observer program immediately (see "Contact Addresses and Numbers" on page A-61).

A strobe light is provided by the Observer Program along with your immersion suit. The strobe light must be attached to your suit by a lanyard about 30 inches long allowing you to hold it above your head without obstruction.

You should never embark on a vessel without a NMFS issued immersion suit with an attached functional strobe light.

Quick Donning Technique

Practice putting on your immersion suit. The Observer Program requires trainees to don the suit in one minute or less, but the faster you are in an emergency, the better! Practice putting on your suit in different situations, such as in the dark.

1. Sit down and work your legs into the suit. If you take your boots off, bring them with you, you'll need them on shore.



- Roll up onto your knees. Put your weak arm into the suit first, then pull the hood over your head. If you have long hair, tuck it into the hood well. If you wear glasses, decide whether you are going to put them in a pocket or wear them.



- Hold the suit below the zipper with one hand and grab the zipper lanyard with your other hand. Lean back to straighten the zipper and pull up. Secure the face flap. Do not inflate the air bladder until you are in the water.



- Jump into the water only as a last resort. Ease yourself into the water if at all possible. If jumping, protect your head by placing your inboard arm over your head. Cross your feet to protect from floating debris. Inflate your air bladder once in the water. It provides additional flotation and keeps your head out of the water.



Life Rafts

Your assigned vessel must have enough life rafts, inflatable buoyant apparatus, buoyant apparatus or life boat capacity for all aboard. Life rafts are stored in canisters that allow them to float free and automatically

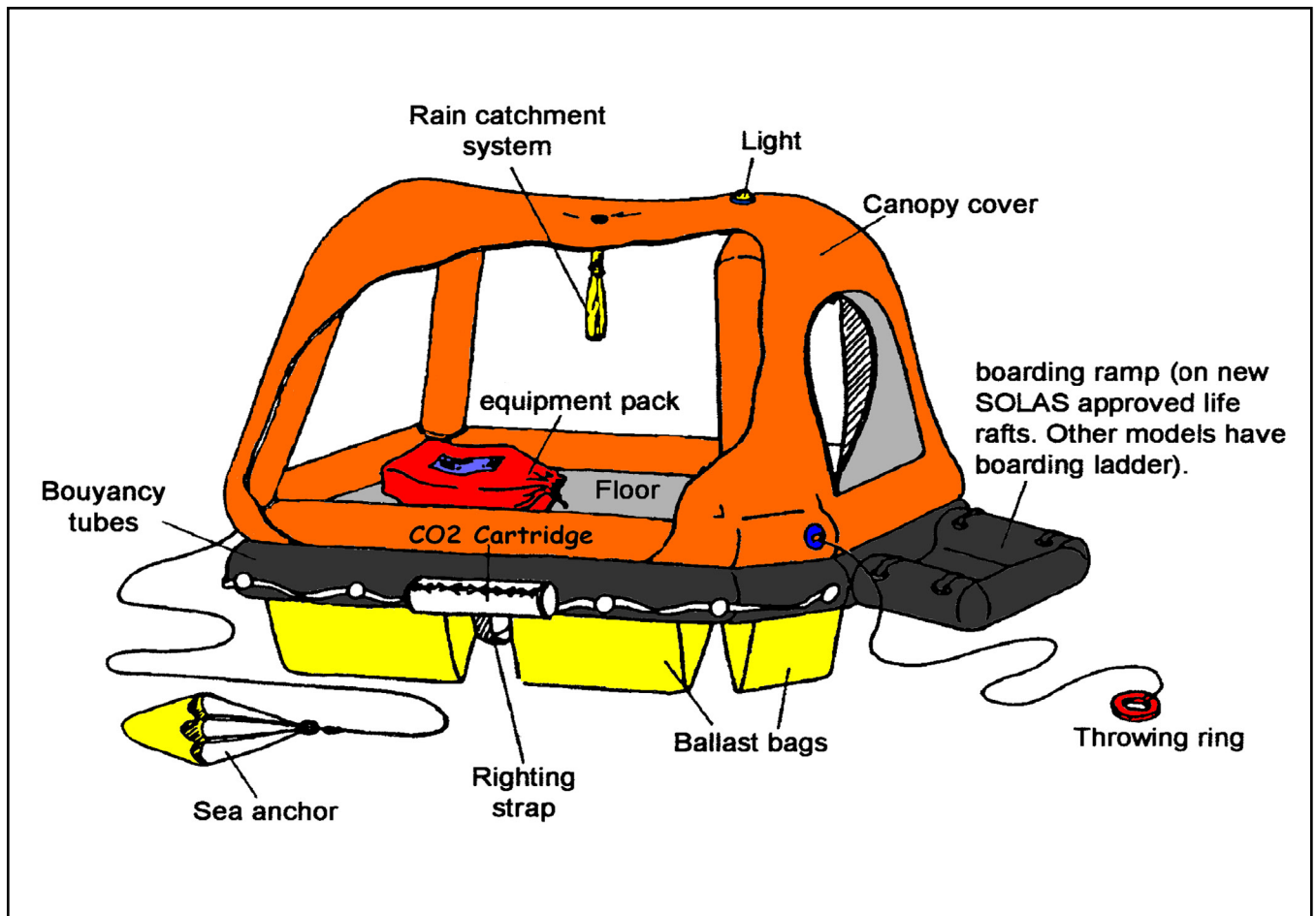

Figure 19-2: Life Raft and Equipment

inflate if the vessel sinks. It is much better to manually launch and inflate the raft if there is time. Know where the rafts are stored, how to remove them from the cradle, where to launch them, and how to inflate them (see Figure 19-2). See item 2 on page 19-3 for raft servicing and inspection requirements. Rigid life boats will not have a USCG Service Due Decal as they do not require annual or biannual inspection.

Rafts with Alternative Float Free Arrangements

Not all vessels will carry a life raft that is secured to the vessel via a cradle and hydrostatic release. These rafts are classified as having an alternative float free arrangement. The rafts must still be in a float free location, provide sufficient capacity for the entire crew, be serviced at the appropriate intervals, and the painter line must still be secured with a weak link.

Rigid Life Boats

Another alternative to a traditional life raft is a rigid life boat. These rigid capsule like life boats, serve the same purpose as a life raft. They must still be located in a float free location and have sufficient capacity for everyone onboard. If your vessel is equipped with a rigid life boat be sure the master of the vessel briefs you on its use prior to embarking. You should also confirm with the captain that the rigid life boat is equipped with a SOLAS kit appropriate for the vessel's area of operation.

Valise Life Rafts

Smaller vessels may also use a Valise life raft to achieve the needed capacity for everyone onboard. A Valise raft is a raft that is stored in a bag rather than a canister and is not required to be stored on deck and rigged to deploy automatically. They are required to be easily accessible in an emergency and be serviced annually. Valise rafts are common on smaller vessels that must increase their raft capacity for additional crew such as the observer.

If you have any concerns regarding the survival craft on your vessel contact Observer Program staff or the USCG. Contact information can be found on page A-61.

EPIRBs

The vessel will have at least one EPIRB (Emergency Position Indicating Radio Beacon) mounted in a float-free bracket that will be automatically activated in the event of sinking. The signal is received by satellite and will identify the sender. It is important to know where the EPIRB is located and how to activate it manually. In the event of an abandon ship emergency it is an item you

want to take with you. Someone will be assigned that duty on the station bill (Figure 19-3). Be sure to locate the EPIRB(s) on your vessel and read the directions on how to activate them. The type of EPIRB required is dependent upon the vessel size, number of crew and area of operation. Smaller vessels may only be required to carry a category 2 EPIRB which will not be float free. Vessels less than 3 nautical miles from shore may not be required to have an EPIRB. Contact your employer, the USCG or Observer Program staff if you have questions about safety equipment required for your assigned vessel.

Personal Locator Beacons, PLBs

You will be issued a Personal Locator Beacon, a small hand held personal EPIRB, along with your sampling equipment. The PLBs are GPS equipped units that, when activated, send your exact GPS coordinates along with the 406 alphanumeric signal to the SARSAT/ COSPAS Mission Control Center. When the signal is received, the Mission Control Center mobilizes the USCG, and provides them with information on the person issued the PLB along with your exact coordinates. This information can drastically decrease rescue times. *You must never embark on a vessel without your PLB.*

In the case of a serious life threatening emergency your PLB should be activated immediately. Once your PLB is activated in an emergency, do not turn it off until you have been rescued or the emergency is resolved.

If you accidentally activate your PLB you must:

- Turn off the PLB.
- Tell the Captain.
- Report the false alarm to the USCG at 1-855-406-USCG (8724) or via radio. You will be asked for the PLB's unique alphanumeric code, date, time and location.
- Call your employer.

Once the emergency that caused you to activate your PLB is resolved, you should contact your employer immediately and inform them of the situation.

If your PLB has been activated for any reason it must be returned to an Observer Program office and you will be issued another one. All PLBs must be returned to the manufacturer following activation to receive a fresh battery.

| EMERGENCY ASSIGNMENTS | | | | |
|-----------------------|-------------------------------------|---|-----------------------------------|--|
| POSITION | ABANDON SHIP | FIRE | PERSON OVERBOARD | FLOODING |
| | Go To & Bring | Go To & Bring | Go To & Bring | Go To & Bring |
| Captain | Wheelhouse, radio maneuver vessel | Wheelhouse, radio maneuver vessel | Wheelhouse, radio maneuver vessel | Wheelhouse, radio maneuver vessel |
| 1st Mate | Life raft, immersion suit | Fight fire | Throw ring, lookout | Plug hole, pump |
| Deckboss | Life raft, immersion suit | Assist in fire fighting | Wheelhouse, radio maneuver vessel | Assist plugging hole and pumping |
| Deckhand | Communicate, EPIRB, count crew | Communicate, boundary person, remove hazards, get survival gear | Communicate, assist where needed | Communicate, assist where needed, secure hatches |
| Observer | Debarkation station, immersion suit | Wheelhouse, immersion suit | Lookout, assist where needed | Debarkation station, immersion suit |

Figure 19-3: Example of a Station Bill

Personal Survival Kits

A personal survival kit can take up very little space in an immersion suit, yet greatly enhance your ability to survive. Think of the seven steps to survival and choose items that may help you. Items such as a knife, dental floss (a strong multi-purpose line), plastic garbage bags, matches, signal mirrors, a compass, hard candy, or bouillon cubes are small items that fit in a zip-lock bag and could save your life. Vessels may have an emergency bag stored and a person named in the station bill to bring it.

There are four general required elements in personal survival kits:

- Shelter
- Signals
- Personal Health
- Fire

These items will vary depending on the individual, environment, and activity. Items should be multipurpose.

SUMMARY

You will learn much about sea safety and survival from the vessel personnel, who probably have many years of sea experience among them. *Ultimately, the responsibility is upon you to survive.* It is easy to think “this will never happen to me” and “the captain will know what to do,” but those thoughts may cost you your life. Take the time to learn as much as you can, and consider what your actions will be in emergency situations. Visualize yourself and your actions in emergency scenarios in the factory, on deck, in your bunk, or anywhere you spend time. Having thought about an emergency will make your actions more automatic, and the time saved may save your life. Your life is worth far more than any data you could collect in the fishery.

This page intentionally left blank.



REGULATIONS AND COMPLIANCE

Table of Contents

| | |
|--|-------|
| Introduction | 20-1 |
| Observer Role in Regulatory Compliance | 20-2 |
| Reporting Potential Violations | 20-2 |
| Victim Crime Violations | 20-3 |
| Resource Violations | 20-4 |
| Guide to Documentation | 20-5 |
| Steps After Reporting a Potential Violation | 20-6 |
| Protection of Observers | 20-6 |
| Victim Impact and Support | 20-7 |
| Victim Rights | 20-8 |
| Selected Regulatory Requirements | 20-8 |
| Harassment and Assault | 20-9 |
| Magnuson Confidentiality | 20-10 |
| Observer Responsibilities §679.53 | 20-10 |
| Observer Provider Responsibilities §679.52 | 20-11 |
| Observer Program §679.50 | 20-12 |
| Vessel and Processor Responsibilities §679.51 | 20-12 |
| Record Keeping and Reporting §679.5 | 20-13 |
| Prohibited Species §679.21 | 20-14 |
| Halibut §679.7 | 20-14 |
| Crab §679.7 | 20-14 |
| BSAI Prohibited Species Donation (PSD) Program §679.26 | 20-15 |
| Improved Retention/Improved Utilization (IR/IU) §679.27 | 20-15 |
| Monitoring Salmon Bycatch in Pollock Fisheries §679.21 and §679.28 | 20-15 |
| Amendment 80 and Bin Monitoring Requirements §679.28 and §679.93 | 20-17 |
| Regulations Specific to Non-AFA Trawl Catcher/Processors Fishing in the BSAI | 20-17 |
| Halibut Deck Sorting Monitoring Requirements §679.120 | 20-19 |
| Seabird Avoidance Gear and Methods For Longliners §679.24 | 20-21 |
| Shark Finning 50 CFR §600.1203 | 20-22 |
| Marine Mammals 50 CFR §216 and §229 | 20-22 |
| Observer Procedures During Coast Guard Boarding | 20-24 |
| Transportation Workers Identification Credentials (TWIC) | 20-25 |
| Observer Health and Safety §600.746 | 20-25 |
| Marine Pollution (MARPOL) Regulations | 20-26 |
| Vessel Operator Obligations | 20-26 |
| Federal Requirements for Commercial Fishing Industry Vessels | 20-27 |

INTRODUCTION

This chapter contains information that will assist you to fulfill your role monitoring for and documenting compliance information and suspected potential violations (see Deployment Responsibilities on 2-2 and Observer Responsibilities on 20-10).

Compliance information can be found throughout the observer sampling manual, in nearly all sections. Follow the guidance in this section regarding documenting and reporting potential violations. This chapter contains excerpts of regulations specific to your work as an

observer. However, this Manual does not contain the entire text of any regulation. *Vessel owners and operators can access the full text of the regulations at <http://alaskafisheries.noaa.gov>.*

All questions regarding Observer Program policies and/or sampling procedures should be referred to an Observer Program staff member, see “Contact Addresses and Numbers” on A-61.

OBSERVER ROLE IN REGULATORY COMPLIANCE

Observers are required to report accurately any observations of potential violations relevant to the conservation of marine resources or their environment. The observer's role in monitoring compliance is quite different from the role of a NOAA Fisheries Office of Law Enforcement (OLE), Enforcement Officer. Observers are not enforcement and do not issue citations, or take enforcement action. Compliance information you collect is reported to fisheries enforcement and evaluated for potential enforcement action by sworn law enforcement Agents and Officers. Enforcement action may range from outreach, education, warnings to monetary penalties, and civil or criminal prosecution. Since observers are required by regulation to document and report potential resource violations, it is expected that observer conduct themselves according to the regulations as well.



Observers must not advise the crew on regulations, interpret regulations, or provide legal advice.

Observers are responsible for monitoring activities aboard the vessel, documenting potential violations, and completing written statements. Observers are encouraged to inform industry personnel of potential violations if they feel safe to do so and if they determine it will not affect their ability to complete their job. However, this is not a requirement.

In accordance with 50 CFR 679.53(b)(2)(ii), you must accurately report any observations of suspected violations. This may entail additional interviews with OLE after your debriefing. You may also be requested to provide information as part of an investigation even if you did not report a violation. Additionally, you may be requested or subpoenaed to testify in a hearing.

Questions regarding an observer's fisheries compliance role should be directed to an Observer Program staff member (see A-61 for contact information).

REPORTING POTENTIAL VIOLATIONS

As an observer, you observe and monitor fishing activities, document suspected violations and report compliance information to NMFS. You also have the opportunity to provide compliance assistance to the industry by notifying a vessel captain or plant manager when you recognize a potential violation; this does not

mean that you ensure the industry complies with the regulations. Keep in mind, you are not an expert on the regulations, and should NEVER advise industry how to comply with specific regulatory requirements. Your role is to monitor and document and when feasible and safe to notify the industry of recognized potential violations. Thoroughly document ALL instances when you notify vessel personnel of ANY potential violation(s).

Reporting when still in the field

After you've identified a potential violation and documented the details your logbook, you have several points of contact available while you are in the field.

Points of contact

- **Observer Program Staff:** Training staff, inseason advisors and field staff are available by phone and email. Observer Program staff works closely with fisheries enforcement and observer providers to distribute information as appropriate and support observers in the field. See page A-61 for contact information.
- **Observer Provider:** Your employer is required to have someone on call 24 hours a day while observers are in the field to handle emergencies and logistics. Providers are also required to notify NMFS of any potential violations they become aware of.
- **Office of Law Enforcement:** Observer Liaison Agents are available by phone and email to provide immediate support and protection for observers in the field. OLE may coordinate with the USCG, Alaska Wildlife Troopers, and/or local police departments to help provide the appropriate level of support. OLE may also coordinate with the observer program and/or observer providers if appropriate to the situation.

How you notify and who you contact may depend on your personal preference, access to and type of communication equipment available, and how long you predict it will be until you reach a port or additional resources. When you communicate your situation, specifics are helpful to provide the best support; if you need assistance, details about what you would like done, when, and by whom, are appropriate. A clear request from you allows for a more focused and personalized response.

Potential violations that you identify in the field may vary, as will the urgency and importance of notifying NMFS in a timely manner. All potential violations are

important, but the office of Law Enforcement places the highest priority on violations that impact observers or data collection. For this reason, notify someone (see “Points of Contact”, above) as soon as you recognize any of the following:

- Assault
- Verbal threat or threatening behavior
- Behavior or actions that jeopardize your safety or the safety of others
- Unwanted sexual advances of a physical or verbal nature
- Behavior or actions that interfere with or bias data collection
- Tampering with or destroying samples, data, equipment, or personal effects
- Behavior that creates a hostile or offensive work environment, or has the purpose or intent of intimidating or interfering with data collection
- Requests or pressure to change sampling procedures or data
- Requests or pressure to perform crew member duties

Unwanted and unwelcome behavior can come from a fellow observer. Please report all unwanted unwelcome behavior you experience, even if it involves a fellow observer.

Before taking action, OLE will consider the level of urgency, potential impacts to the observer in the field, impacts on data collection, and potential impacts to the resource. The observer program, observer providers and law enforcement have a cooperative working relationship to provide support in the field, and they will share information as required or appropriate.

VICTIM CRIME VIOLATIONS

Potential victim violations include incidents that violate regulations protecting observers (see “Regulations Protecting Observers” on page 20-6). These incidents are taken very seriously and are the highest enforcement priority. Victim incidents can be very personal and may be difficult to discuss with agency staff. The observer’s immediate privacy and personal safety are NMFS first

concerns. When appropriate, Enforcement works closely with advocate organizations, the Workplace Violence Prevention and Response office, the Observer Program, Observer Providers, or the Industry to coordinate the appropriate level of support and provide resources to an observer victim. Similarly to resource violations, identify, notify/report, and document instances of harassment.

Identify

Observers may face difficult conversations, interactions, and sampling situations during deployments. In such an isolated environment, potential victim violations may be hard to identify. It is common to minimize the situation or to self-blame for the actions or behaviors of someone else. Full impact of a situation may not be apparent until the victim is away from the incident. A potential victimizing situation may not become apparent until the debriefing interview or even later. Some signs of victim impact may include: a sudden change in behavior, avoidance of certain spaces and/or people, creating a plan of escape/safety. See “Victim Impact and Support” on 20-7 for more guidance.

Notify/Report

Assistance is available to protect and aid observers during or after deployment. Your personal support will be the first priority. If law enforcement action is necessary, OLE will communicate each step with you and may partner with the Alaska State Troopers, USCG and other Law Enforcement to provide the most appropriate enforcement support to ensure observer safety. Not every report of a potential victim violation results in enforcement action. Many reports provide the opportunity to coordinate support to a potential victim and possibly resolve a situation prior to it rising to the level of harassment.

If data quality is affected because of a potential victim violation, you are not at fault. You may want to inform your debriefer that circumstances on board negatively affected data quality. If you do not feel like disclosing this personal information to observer program staff, you may discuss this directly to OLE, to an Alaskan State Trooper, or to Coast Guard personnel.

You may also disclose directly to an advocacy service; however the advocacy services are anonymous and will not report what happened to you to law enforcement. Please refer to “Figure 20–2: Advocacy and Help Resources For Observers” on page 20-8. Contact

REGULATIONS AND COMPLIANCE: RESOURCE VIOLATIONS

information for OLE Field Offices can be found on page A-61.

If you experience significant emotional impact or a severe offense that impacts you personally, you may be the victim of a crime. You have rights outlined on page 20-8 under “Victim Rights” and you have the right to choose who and when you report such a crime to. Observer program staff as well as the observer liaison office with the Alaska Division OLE have been trained to support you through your personal process.

It is never too late to report a potential victim crime. Delayed reports are taken as seriously as an immediate report.

Document

Victim violations are documented differently from resource violations. Observer support becomes the agency’s highest priority. In addition to documenting factual information as described for resource violations, it is important to document your thoughts, feelings, and reactions. These responses become evidence of the severity and pervasive nature of the incident. Sometimes seemingly insignificant events or annoyances escalate over time. Observers are encouraged to document these events at the time they recognize the relevance to the overall incident. Accurately describe interactions including events leading up to and following an incident and including any steps taken to resolve the incident. All contributing or resolving information is relevant to a potential victim crime.

It is important to document events and behavior that you may interpret as harassment or is otherwise conduct that is upsetting or bothersome to you. Even if you are able to manage or resolve the situation on your own, such behavior may be more difficult for subsequent observers. When documented, the Observer Program and Enforcement is more likely able to recognize patterns of troubling behavior and address issues before they become more serious.

RESOURCE VIOLATIONS

Your resource violation compliance role is straightforward: identify, notify (when feasible), and document. The decision to notify a captain or plant manager of a potential resource violation will depend on the circumstances of the situation, when you recognize a potential violation, and if you feel safe in doing so. For

assistance in identifying a potential resource violation and important information to document, contact your inseason advisor or other Observer Program staff member. The observer program will notify Enforcement as necessary.

Identify

Routine observation of all activities aboard a vessel is your first step in identifying compliance infractions. An observer will most often recognize potential violations that directly affect their sampling duties, such as failing to notify 15 minutes prior to bringing catch on board, or presorting the catch prior to their sample. Other potential violations such as discarding plastic bags overboard may be obvious and may not interfere with sampling duties. If you are unsure if a specific situation or event is a potential violation, contact an Observer Program staff member with the details for guidance.

Notify

If you have identified a potential resource violation, notify the vessel’s captain (or the plant manager) if this can be done without potential compromise to your work environment or personal safety. By informing industry of potential violations, you are providing an opportunity to voluntarily comply and possibly mitigate the situation. If you do not notify the captain or manager of the potential violation, document the reasons you did not in the Daily Notes section of the observer logbook. Please refer to the following “Document” section for instruction on how to document a potential violation.

Effectively communicating potential violations you witness to industry requires good judgment and a positive approach. If a potential violation is witnessed, organize the facts and approach the captain or plant manager in a calm and reasonable manner using conflict resolution skills.

The captain/plant manager’s response to your notification may influence future Enforcement action(s). In many cases, voluntary compliance will occur immediately. If the violation(s) continue, document the situation and use your judgment to decide if you should inform the captain a subsequent time. Your documentation will be key in how Enforcement decides to take action.

If a potential violation affects sampling or data collection, notify the observer program. The observer program will coordinate with the observer(s) and OLE (when

appropriate) to assist in resolving the data collection concern.

Document

As part of your daily routine, document the events of the day in the Daily Notes section of the Observer Logbook (see “Observer Logbook Entries” on page 2-16). Detailed and thorough documentation is essential to quality scientific data and compliance information.

The Observer Logbook is frequently the primary document used by enforcement as evidence of fishing violations. Writing a statement during debriefing is much easier if potential violations are documented in your daily notes as outlined below. Unauthorized release of observer information contained within an Observer Logbook is a violation of the Magnuson Stevens Act. *Special care must be taken to safeguard observer information as confidential and to protect it from tampering.*

GUIDE TO DOCUMENTATION

When do I document?

Document an incident as soon as possible following your priorities in this Manual. Document each event in chronological order, with attention to detail. All entries must be dated. If a potential violation is recognized at a later date, document when the event occurred as accurately as possible. If you must estimate dates and times when potential violations occurred, please indicate so in your documentation.

Where do I document?

Most potential violations will be documented in the Daily Notes section of the Observer Logbook, but any primary documentation can be used as evidence. Retain any and all primary documentation and reference these items when reporting potential violations in your Observer Logbook and during debriefing. Common primary documents include the following:

- Daily Notes
- Deck Forms
- Inseason Messages
- Data Forms
- Vessel Logbook

- Fish tickets/landing reports
- Photograph/video
- Vessel survey
- Personal notes/journal

What do I Document

Document factual information about each potential resource violation. Be thorough and objective. Objective documentation is critical to clearly conveying compliance information. Subjective comments, such as opinions and conclusions must be left out.

All written comments in the Observer Logbook must be in ink, and events should be recorded in chronological order.

All logbook entries of suspected violations should contain the following basic elements:

Who: Identifying characteristics such as: Names (vessel or person), nicknames, tattoos, permit numbers, job title/position on the vessel, witnesses, and anyone involved in resolving the incident.

What: Describe the events and circumstances in narrative form. Include information leading up to the event and following, any resolution to the situation (if any), and the number of times the event occurred – quantify where appropriate. Examples: “While targeting P. Cod, 35 halibut hit the crucifer prior to discard during haul 42”; “I tallied these incidents on my deck sheet page 59.”

When: Identify the time and date of the suspected violation. If estimating a time, give other details that may help identify the time, such as haul number, trip number, who was on shift, where fishing occurred, how near to the end or start of your shift, etc.

Where: Identify the vessel’s position or the plant location as specifically as possible at the time of the suspected violation or where the event occurred on board the vessel.

Why and How: Document observations and any conversations with the crew members. Be as objective as possible and cite factors which may provide mitigating or aggravating information. Consider the following questions:

REGULATIONS AND COMPLIANCE: STEPS AFTER REPORTING A POTENTIAL VIOLATION

- Were there circumstances beyond the control of vessel or plant personnel such as severe weather, mechanical breakdowns, or injuries?
- Was the suspected violation intentional? On whose orders, or with whose knowledge and why? Describe any effect the potential violation had on your ability to perform your observer duties.

Compliance Statements

Documented potential violations will be discussed with your debriefer. You may be asked to clarify your notes or to complete a written statement describing the events. Your statement should not contain repeated details already in other primary documentation. The statement should contain the basic elements of the violation, any details not included elsewhere, and references to primary documents. References should specify where detailed information can be found, including document names, page numbers, dates, and/or haul numbers.

STEPS AFTER REPORTING A POTENTIAL VIOLATION

If you submit a statement, it will be forwarded as appropriate to the USCG or to Enforcement. Provide the Observer Program with a reliable phone number or mail address so they can reach you. Your responsibility as a groundfish observer regarding suspected violations may require a conversation with an agent or officer. Additionally, if you experienced harassment of some type, victim advocacy information will be provided to you, and an Observer Liaison Agent will be in contact with you to ensure you are being supported.

When you discuss a potential violation with the vessel master, they will most often take steps to change that behavior. Therefore, many complaints submitted by observers fall into the “voluntary compliance” or “information only” categories. The majority of these complaints will not require enforcement action against the operator or fishing company.

Violations may be dealt with by a Summary Settlement or other civil or criminal prosecution. The Summary Settlement system allows NMFS Enforcement agents and officers to levy fines on an individual or a vessel company for certain common violation types. This form of enforcement action is comparable to a traffic ticket. More serious or repeated violations can result in civil or

criminal prosecutions. These prosecutions occasionally result in trials or hearings.

If your written statement is not acted upon by AKD, the information is not lost. It will be included in the Enforcement database for potential use in policy or program consideration or for future enforcement action(s). Over time, Enforcement may identify egregious patterns of behavior. Without complete, objective documentation of these suspected violations, AKD has difficulty pursuing an investigation. Notes taken by observers are often the best source of information about at sea compliance.

Investigations may take extensive periods of time to complete, and you may be contacted several weeks or months after you have submitted a statement. If you were witness to a violation that results in civil or criminal prosecution, you will be notified beforehand. It is reasonable and common to be nervous about the process, but rest assured that the investigating Agent or Officer and the General Counsel attorney assigned to the case will be available to you if you have questions.

PROTECTION OF OBSERVERS

The protection of observers is a high priority for the Office of Law Enforcement. There is a zero tolerance for any type of harassment of observers (see Figure 20-1: Observer Harassment Warning poster on 20-7) NMFS strives to promote a safe and harassment-free work environment to protect observers and contribute to the collection of high quality data. Additionally, your employer and vessel/plant owners and operators have the regulatory responsibility to protect you and your data.

REGULATIONS PROTECTING OBSERVERS

50 CFR 679.7(g): It is unlawful for ANY PERSON to do any of the following: (please note that “ANY PERSON” can include and is not limited to fellow observers, vessel crew, plant workers, and officer level personnel):

1. Forcibly assault, resist, impede, intimidate, sexually harass, bribe or interfere with an observer.
2. Interfere with or bias the sampling procedure employed by an observer, including physical, mechanical, or other sorting or discarding of catch before sampling.
3. Tamper with, destroy, or discard an observer’s collected samples, equipment, records, photographic

film, papers, or personal effects without the express consent of the observer.

4. Prohibit or bar by command, impediment, threat, coercion, or by refusal of reasonable assistance, an observer from collecting samples, conducting product recovery rate determinations, making observations or otherwise performing the observer's duties.
5. Harass an observer by conduct that has sexual connotations, has the purpose or effect of interfering with the observer's work performance, or otherwise creates an intimidating, hostile, or offensive environment. In determining whether conduct constitutes harassment, the totality of the circumstances, including the nature of the conduct and the context in which it occurred, will be considered. The determination of the legality of a particular action will be made from the facts on a case-by-case basis.
6. Fish for or process fish without observer coverage required under Subpart E of this part.
7. Embark on a fishing trip to directed fish for groundfish or to fish for halibut with hook-and-line gear without carrying an observer if the fishing trip is selected for observer coverage per § 679.51(a)(1)(ii)(C)(2), or the vessel is selected for observer coverage per § 679.51(a)(1)(ii)(D).
8. Require, pressure, coerce, or threaten an observer to perform duties normally performed by crew members, including but not limited to, cooking, washing dishes, standing watch, vessel maintenance, assisting with the setting or retrieval of gear, or any duties associated with the processing of fish, from sorting the catch to the storage of the finished product.



Figure 20-1: Observer Harassment Warning Poster distributed by OLE to all vessels required to carry an observer(s)

Victim Impact and Support

Harassment, assault, and sexual assault disrupt the lives of employees, families, co-workers, and many others. Victims may feel shock, depression, guilt, loss of trust, fear, anger, frustration, humiliation, and embarrassment. They may experience a loss of self-esteem, motivation, and privacy. It is normal for victims of crime to minimize the traumatizing event or events to blame or doubt themselves.

You are not to blame! No matter what choices you make, it does not give someone the right to assault you or treat you in a way that is clearly unwelcome. The person who chooses to commit an act of violence or control is solely responsible for their crime.

You are not alone. After you have reported the crime, a specially trained team will answer your questions, support and help you. Team members are added as your needs dictate. This team may be one or more of the following: Office of Enforcement, Observer Program staff members, your employer, an advocate, a medical professional, the vessel company and captain, a legal professional, and/or others.

Confidential help is available from Advocate organizations free of charge. Victim advocacy organizations provide confidential support for victims of crimes including assault, sexual assault, workplace harassment, and rape. They provide immediate crisis support, assistance at the hospital if an exam is necessary, law enforcement accompaniment, court and medical accompaniment, individual crisis counseling, support groups, information, and referral. Advocate organizations are listed on Figure 20-2.

REGULATIONS AND COMPLIANCE: SELECTED REGULATORY REQUIREMENTS

| Organization/ Location | Phone | Website |
|------------------------------------|--------------|---|
| NOAA SASH Helpline WVPR Program | 866-288-6558 | noaasashhelpline.org https://www.noaa.gov/workplace-violence-prevention-response-program |
| RAINN (National) | 800-656-4673 | rainn.org andvsa.org |
| ANDVSA (Alaska) | 907-586-3650 | andvsa.org |
| Careline Alaska | 877-266-4357 | carelinealaska.com |
| Crisis Clinic (Seattle) | 866-427-4747 | crisisclinic.org |
| STAR (Anchorage) | 800-478-8999 | staralaska.com |
| USAFV (Dutch Harbor) | 907-581-1500 | usafvshelter.org |
| SPHH (Homer) | 800-478-7712 | havenhousealaska.org |
| AWARE (Juneau) | 800-478-1090 | awareak.org |
| WISH (Ketchikan) | 800-478-9474 | wishak.org |
| KWRCC (Kodiak) | 888-486-3625 | kwrc.org |
| SCS (Seward) | 907-224-3027 | seaviewseward.org |
| SAFV (Sitka) | 800-478-6511 | safv.org |
| KCSARC (Seattle) | 888-998-6423 | kcsarc.org |

Figure 20-2: Advocacy and Help Resources For Observers

Workplace Violence Prevention and Response Program

The Workplace Violence Prevention and Response program (WVPR) is an internal NOAA resource to help Impacted Persons (IP) (terms “victim,” and “impacted persons” may be used interchangeably) through crisis intervention, referrals, and emotional support using local and national resources referenced in the table above. WVPR works collaboratively with all partnering agencies (e.g., OLE) to provide a trauma-informed victim centered

response. The program’s Regional Coordinators are specially trained to help facilitate navigation of resources based on the IP’s individual needs. Information about all sexual assault and sexual harassment incidents are closely monitored and considered confidential. Only those who have an official “need to know” are to have access to this information dependent upon the IP’s reporting option. All NOAA employees, contractors, and affiliates may receive support from WVPR regardless of the place or time of occurrence. For additional information see Workplace Violence & Prevention Response on A-63.

Victim Rights

During a law enforcement investigation, you will be informed of the status of your case. Your case agent will remain your principal contact. If you have questions, be sure to contact him or her as soon as possible. An investigation can be complex and lengthy. Remember, your interests are important. It is normal to have questions. Your case agent is there to help.

Below is a list of rights given to victims under the Crime Control Act of 1990:

- The right to be treated with fairness and with respect for your dignity and privacy.
- The right to be reasonably protected from the accused offender.
- The right to be present at all public court proceedings related to the offense, unless the court determines that testimony by the victim would be materially affected if the victim heard other testimony at trial.
- The right to confer with the attorney for the Government in the case.
- The right to restitution.
- The right to information about the conviction, sentencing, imprisonment, and release of the offender.

SELECTED REGULATORY REQUIREMENTS

This section includes summaries of pertinent regulations and provides guidance to observers on compliance related duties relevant to these regulatory sections. Full regulations are presented in the Code of Federal Regulations (50 CFR 600 and 679) which implement

the Fisheries Management Plans (FMP) for the Bering Sea/Aleutian Islands (BSAI) and Gulf of Alaska (GOA) areas. Additional information on these regulations and current information on news releases, fishery closures, restricted area maps and regulations may be obtained through the Alaska Regional (AKR) Office, <http://www.alaskafisheries.noaa.gov>.

Supplementary changes to regulations are available at NMFS offices. Substantive supplementary changes to groundfish, marine mammal, safety, and marine pollution regulations are published in the Federal Register. Copies of the various CFRs are available in local libraries and in state or federal court buildings.

The summary in this Manual does not supersede, amend, or detract from federal regulations or law as printed in the Federal Register or the Code of Federal Regulations. This summary does not, nor is it intended to, create any rights, substantive or procedural (enforceable at law by any party in any matter, civil or criminal) and it may not be relied on for any such purpose. This summary is for general informational purposes only. *This is not a complete summary, nor is it quoted verbatim from federal law.*

Overview

Federal fisheries regulations in the BSAI and GOA are developed by the North Pacific Fisheries Management Council, approved by the U.S. Department of Commerce and administered by the National Marine Fisheries Service. In addition to fisheries regulations, commercial fishers are required to comply with many other regulations, such as those authorized by the Marine Mammal Protection Act and the Endangered Species Act.

The regulations contained in this section of your manual are enforced by the NOAA Fisheries Office of Law Enforcement (OLE), Alaska Division (AKD) and the U. S. Coast Guard. AKD Special Agents also work closely with Observer Program staff and with federal, state, and local law enforcement agencies.

Groundfish regulations in the BSAI and GOA are designed to conserve stocks and to protect established halibut, herring, crab and salmon fisheries. Regulatory tools used to manage the fisheries include fishing area designations, fishing seasons, gear limits, catch quotas and bycatch quotas.

50 Code of Federal Regulations (CFR) Part 679 contains Federal Regulations for Fisheries of the Exclusive Economic Zone off the Alaska coast. The Part is made up of several Subparts, each Subpart is split into Sections, notated by the symbol §. Each Section is further split into Paragraphs that we most frequently reference. Each Paragraph has several levels of designation as described below:

- Level 1 (a), (b), (c), etc.
- Level 2 (1), (2), (3), etc.
- Level 3 (i), (ii), (iii), etc.
- Level 4 (A), (B), (C), etc.
- Level 5 (1), (2), (3), etc.
- Level 6 (i), (ii), (iii), etc.

Victim Crimes

A victim is defined as a person who has suffered physical or emotional harm, property damage, or economic loss as a result of a crime. These crimes against observers are the highest priority of the Office of Law Enforcement. If you find yourself in one of these situations, take care of yourself first. Prioritize your safety and personal needs above data collection. According to Title 16 United States Code 1857(1)(L) it is unlawful for any person to forcibly assault, resist, oppose, impede, intimidate, sexually harass, bribe, or interfere with any observer on a vessel under this chapter, or any data collector employed by the National Marine Fisheries Service.

Harassment and Assault

The most serious crimes against observers are intimidation, coercion, assault, harassment, sexual assault, and rape. These are criminal offenses. On a vessel, your most immediate support may come from a crew member, inseason advisor, or another observer. For your safety and that of future observers, if possible inform the captain or plant manager, your employer, or NMFS. After you have made a report, the agency will continue to work with you to provide information and support options. See “Victim Impact and Support” on page 20-7. If you are still at sea, AKD will work with you and Observer Program staff to monitor the situation to ensure it does not become worse. If necessary, immediate actions will be taken to ensure your safety. Contacts for AKD and other support can be found in “Contact Addresses and Numbers” on page A-61 of this manual.

REGULATIONS AND COMPLIANCE: SELECTED REGULATORY REQUIREMENTS

Second to your safety is the preservation of evidence. This may include gathering physical evidence of the harassment, assault, or sexual assault. As you cope with this difficult and personal process, remember it's not your fault. There is no excuse for behavior that harms you or anyone else.

Sexual Harassment

Sexual harassment is a form of sex discrimination that violates Title VII of the Civil Rights Act of 1964. Unwelcome sexual advances, requests for sexual favors, and other verbal or physical conduct of a sexual nature constitutes sexual harassment when submission to, or rejection of, this conduct explicitly or implicitly affect an individual's employment, unreasonably interferes with an individual's work performance, or creates an intimidating, hostile, or offensive work environment.

Sexual harassment can occur in a variety of circumstances, including, but not limited to the following:

- The victim as well as the harasser may be a man or a woman. The victim does not have to be of the opposite sex.
- The victim does not have to be the person harassed, but could be anyone affected by the offensive conduct.
- Unlawful sexual harassment may occur without economic injury to the victim.

While some behavior is clearly offensive, often it is unclear or not clearly communicated. In this event it may be necessary for you to directly inform the harasser that the conduct is unwelcome and that it must stop.

A determination of whether alleged conduct constitutes sexual harassment, and the legality of a particular action, will be made from the facts, on a case by case basis. For more information on sexual harassment or any other form of harassment or discrimination consult the Equal Employment Opportunity Commission (EEOC) Website at www.eeoc.gov.

Intimidation

Intimidation is another form of harassment. It is an emotional response to someone's actions toward you. The most common intimidation tactics are coercion and verbal aggression. A captain, crew member, or fellow observer may physically threaten you into an action or impede you from acting. They may also direct anger toward you verbally or with confrontational body

language. Some people are affected very little, while others are affected immediately and for some time afterward.

In some cases, you may be able to ignore or defuse this type of behavior. If you do experience an incident that upsets you or causes you to avoid the public areas of a vessel or plant, the person's behavior may have intimidated you. You have a right as an observer to work in an environment free from this kind of harassment.

Magnuson Confidentiality

Observers are not exempt from enforcement action if they are found to be in violation of any statutes of the Magnuson-Stevens Act. This includes 16 USC 1881a §402 - Confidentiality of Information. Observers must not post observer information on the internet, including but not limited to social networking sites and other file sharing sites. Observer information must not be used for personal research projects, publishing articles, or any other unofficial or unapproved purpose(s). Not only is posting observer information on social media against the law but it violates the trust that industry places on observers and the agency to maintain impartiality and scientific integrity.

All observer information must be kept confidential, this includes proper handling and use of observer data both inseason and after debriefing.

Observer information is defined at 16 USC 1802 §3-Definitions (32): ...any information collected, observed, retrieved, or created by an observer or electronic monitoring system... including fish harvest or processing observations, fish sampling or weighing data, vessel logbook data, vessel or processor specific information (including any safety, location, or operating condition observations), and video, audio, photographic, or written documents.

Observer Responsibilities §679.53

Federal groundfish observers are not exempt from laws or regulations. Observers who falsify data, accept bribes, harass other observers, or conspire with someone to do the same may face civil or criminal charges. Observers who violate Standards of Observer Behavior (see "Standards of Observer Behavior" on page 2-7) may face employer disciplinary action or agency decertification. Observers who create a conflict of interest by having a financial interest in or accepting or seeking employment from industry while employed as an observer, may face

agency administrative or civil action. The collection of reliable data is essential to the effective conservation, management, and scientific understanding of the fishery resources of the United States. As such, false data reports, conflict of interest and observer misconduct issues are dealt with seriously.

Observer Provider Responsibilities §679.52

Full Coverage Contractor Responsibilities

Observer provider companies providing observers in the full coverage sector are responsible to provide all logistics to place and maintain observers aboard fishing vessels or at the site of the processing facility. This includes all travel arrangements, lodging and per diem, and any other services required.

Each observer deployed to a shoreside processing facility shall be provided with a working cell phone or pager for notification of upcoming deliveries. If accommodations are more than 1 mile from the assigned shoreside processing facility the observer will be provided with motorized transportation.

If you are unable to perform your duties as an observer because there is no reliable transportation to the plant, please contact an Observer Program office. If your accommodations are inadequate, contact the Observer Program and let your employer know about the problem.

Observer providers must:

1. Provide an observer's salary, benefits, and personnel services in a timely manner.
2. Ensure that the following deployment conditions are met, unless alternative arrangements are approved by the Observer Program: Ensure all data, reports, and biological samples from observer deployments are complete and submitted to NMFS at the time of the debriefing interview.
 - Unless approved by NMFS, observers may not be deployed on the same vessel or at the same shoreside processor for more than 90 days in a 12 month period.
 - Unless approved by NMFS, a deployment may not exceed 90 days.
 - Unless approved by NMFS, a deployment may not include assignments to more than four vessels and/or shoreside processors.

- An observer provider must not move an observer from a vessel or processor before that observer has completed his or her sampling or data transmission duties.
3. Maintain communications with observers. Each observer provider must have an employee on call 24 hours a day to handle emergencies involving observers or problems concerning observer logistics.
 4. Ensure that observers complete debriefing as soon as possible after the completion of their deployment and at locations specified by the Regional Administrator.
 5. Ensure all data, reports, and biological samples from observer deployments are complete and submitted to NMFS at the time of the debriefing interview.
 6. Ensure that all sampling and safety gear are returned to the Observer Program and that any gear and equipment lost or damaged by observers is replaced according to NMFS requirements.
 7. Provide to the Observer Program copies of "certificates of insurance." Report harassment, safety, or observer performance problems within 24 hours after the observer provider becomes aware of the problem.
 8. Assign observers without regard to any preference based on observer race, gender, age, religion, or sexual orientation.
 9. Verify that a vessel has a valid USCG safety decal before an observer may get underway. The certificate may be inspected by the observer.
 10. For each observer employed by an observer provider, either a written contract or a written contract addendum must exist that is signed by the observer and observer provider prior to the observer's deployment that contains the following provisions:
 - Inseason data submission requirements.
 - Requirement to complete in-person mid-deployment data reviews as assigned.
 - Requirement to inform the provider of new mental illness or physical ailments or injury that prevent the performance of duties.
 11. An observer provider must develop, maintain, and

REGULATIONS AND COMPLIANCE: SELECTED REGULATORY REQUIREMENTS

implement a policy addressing observer conduct and behavior for their observers. An observer provider shall provide a copy of its conduct and behavior policy to observers and observer candidates, and each year to the Observer Program. The policy shall address the following behavior and conduct regarding:

- Observer use of alcohol;
- Observer use, possession, or distribution of illegal drugs;
- Sexual contact with personnel of the vessel or processor to which the observer is assigned, or with any vessel or processor personnel who may be substantially affected by the performance or non-performance of the observer's official duties.

Partial Coverage Contractor Responsibilities

The responsibilities of the contractor providing observers to vessels in the partial coverage sector are specified in the contract or through agreement with the Observer Program. In general their responsibilities are identical to those specified in 679.52. One difference to note is the contractor will verify that a vessel intends to maintain a proper lookout at all times while on open water.

Observer Program §679.50

The purpose of the Groundfish Observer Program is to allow observers to collect Alaska fisheries data deemed by the Regional Administrator to be necessary and appropriate for management, compliance monitoring, and research of groundfish fisheries and for the conservation of marine resources or their environment.

Vessel and Processor Responsibilities §679.51

Vessels

An operator of a vessel required to carry one or more observers must:

Observer Use of Equipment

Vessels and shoreside processors must facilitate transmission of observer data by allowing observers to use the vessel's communication equipment and personnel, on request, for confidential entry, transmission, and receipt of work-related messages, at no cost to the NMFS-certified observers or the United States.

Accommodations and Food

Provide at no cost to observers or the United States, accommodations and food on the vessel for the observer(s) that are equivalent to those provided for officers, engineers, foremen, deck bosses or other management level personnel of the vessel.

Safe Conditions

Maintain safe conditions on the vessel for the protection of the observers including adherence to all Coast Guard and other applicable rules, regulations, or statutes pertaining to safe operation of the vessel. This includes Coast Guard Rule 5:

“Every vessel shall at all times maintain a proper lookout by sight and hearing as well as by all available means appropriate in the prevailing circumstances and conditions so as to make a full appraisal of the situation and of the risk of collision.”

See “Maintaining a Proper Lookout” on page 19-7 in the Safety section for additional guidelines if your vessel does not maintain a proper lookout.

All documented vessels must have on board:

- A valid Commercial Fishing Vessel Safety Decal issued within the past 2 years that certifies compliance with regulations found in 33 CFR Chapter I and 46 CFR Chapter I; or
- A certificate of compliance issued pursuant to 46 CFR 28.710; or
- A valid certificate of inspection pursuant to 46 U.S.C. 3311.

Transmission of Data

Vessels required to carry at least one observer at all times or operating in certain fisheries must have NMFS-supplied software installed on fully functional and operational computer hardware and communications equipment. The equipment must have the capability such that all tasks and components of the NMFS supplied software including data entry and storage, communications, and transmissions can be executed effectively aboard the vessel.

Vessel Position

Allow observers access to, and the use of, the vessel's navigation equipment and personnel, on request, to determine the vessel's position.

Access

Allow observers free and unobstructed access to, the vessel's bridge, trawl or working decks, holding bins, processing areas, freezer spaces, weight scales, cargo holds, and any other space that may be used to hold, process, weigh, or store fish or fish products at any time.

Prior Notification

Notify observers at least 15 minutes before fish are brought on board, or fish and fish products are transferred from the vessel, to allow sampling the catch or observing the transfer, unless the observers specifically request not to be notified.

Records

Allow observers to inspect and copy the vessel's daily fishing logbook, daily cumulative production logbook, product transfer forms, and any other logbook or document required by regulations. Observers are also allowed to inspect and copy printouts or tallies of scale weights, scale calibration records, bin sensor readouts, and production records.

Assistance

Provide all other reasonable assistance to enable observers to carry out their duties, including, but not limited to, assisting observers in measuring decks, codends, and holding bins; providing the observers with a safe work area adjacent to the sampling collection site; when requested by observers, assisting in collecting bycatch, assisting in collecting and carrying baskets of fish; and allowing observers to determine the sex of fish when this procedure will not decrease the value of a significant portion of the catch; collecting all seabirds that are incidentally taken on the observer-sampled portions of hauls using hook-and-line gear or as requested by an observer during non-sampled portions of the hauls.

Transfer at Sea (Outside 3 nm)

- Ensure that transfers of observers at sea via small boat or raft are carried out during daylight hours, under safe conditions, and with the agreement of observers involved.
- Notify observers at least 3 hours before observers are transferred, such that the observer can collect personal belongings, equipment, and scientific papers.
- Provide a safe pilot ladder and conduct the transfer to ensure the safety of observers during transfers.

- Provide an experienced crew member to assist observers in the small boat or raft in which any transfer is made.

Shoreside Processor and Stationary Floating Processors Responsibilities

The manager of the processor facility must:

Safe Conditions

Maintain safe conditions at the shoreside processing facility for the protection of observers by adhering to all applicable rules, regulations, or statutes pertaining to safe operation and maintenance of the processing facility.

Operations Information

Notify the observers, as requested, of the planned facility operations and expected receipt of groundfish prior to the receipt of those fish.

Access

Allow observers free and unobstructed access to the shoreside processor's holding bins, processing areas, freezer spaces, weight scales, warehouses, and any other space that maybe used to hold, process, weigh, or store fish or fish products at any time.

Document Access

Allow observers to inspect and copy the shoreside processor's Daily Cumulative Production Logbook, transfer logbook, and any other logbook or document required by regulations; printouts or tallies of scale weights; scale calibration records; bin sensor readouts; and production records.

Assistance

Provide all other reasonable assistance to enable the observer to carry out his or her duties, including, but not limited to, assisting the observer in moving and weighing totes of fish, cooperating with product recovery tests, and providing a secure place to store baskets and sampling gear.

Record Keeping and Reporting §679.5

Observers must be provided access to inspect and copy information from either the paper log or the electronic logbook for the purpose of effort information.

Paper Logbook (DFL, DCPL):

The operator of a vessel required to maintain a NMFS logbook must record haul information in the logbook

REGULATIONS AND COMPLIANCE: SELECTED REGULATORY REQUIREMENTS

within 2 hours of gear retrieval. Each logbook page must be signed at the completion of each delivery or offload and the goldenrod copy of each logbook page provided to the observer after it is signed, and prior to the observer disembarking the vessel.

Electronic Logbook (ELB):

The operator of a vessel required to maintain an electronic logbook or voluntarily using an electronic logbook instead of a paper logbook must enter haul information in the ELB within 2 hours of gear retrieval, and when fishing occurs, provide a signed and printed copy of the log sheet to the observer by 2400 the next day for the previous day's activities. Inactive periods can be recorded on a single log sheet.

The operator of a vessel required to weigh catch on a flow scale is required to enter the haul weight within two hours of the completion of weighing the haul.

Prohibited Species §679.21

The operator of a vessel engaged in directed fishing for groundfish in the GOA or BSAI must minimize its catch of prohibited species. After allowing sampling by an observer, the operator of each vessel must sort its catch as soon as possible after retrieval of the gear and return all prohibited species or parts thereof to the sea immediately with a minimum of injury regardless of its condition.

Prohibited species include:

- Pacific salmon (all species)
- Steelhead trout
- Pacific halibut (see "Halibut §679.7" below for prohibited actions on longliners)
- Pacific herring
- Tanner crab (all species)
- King crab (all species)
- Any groundfish species in any area where the total allowable catch of that species is zero or the species is declared prohibited by a notice of closure.

It is prohibited to retain or possess prohibited species except as permitted under the prohibited species donation program which is described in the "BSAI

Prohibited Species Donation Program (PSD) §679.26" section.

Document the following if observed on a vessel:

- a) Forcefully grabbing, lifting, or throwing a halibut.
- b) Piling of halibut and/or other prohibited species at a point to be discarded later.
- c) Putting prohibited species through a sump, grinder, or fish meal chute.
- d) Stabbing prohibited species with a gaff, pew (a long spear-like gaff), knife, or other sharp object.

Halibut §679.7

With respect to halibut caught with hook-and-line gear deployed from a vessel fishing for groundfish, or for the release of undersized halibut from vessels directed fishing for halibut as prescribed in § 300.62, the following actions are prohibited:

1. Fail to release the halibut outboard a vessel's rails.
2. Release the halibut by any methods other than:
 - Cutting the gangion;
 - Positioning the gaff on the hook and twisting the hook from the halibut;
 - Straightening the hook by using the gaff to catch the bend of the hook and bracing the gaff against the vessel or any gear attached to the vessel.
3. Puncture the halibut with a gaff or other device.
4. Allow the halibut to contact the vessel, if such contact causes, or is capable of causing, the halibut to be stripped from the hook.



If fishing Pacific halibut under an IFQ, the minimum legal size that must be retained is 82 cm. Discarding legal sized halibut is unlawful.

Crab §679.7

It is prohibited to have on board at any particular time, 20 or more crab of any species which have a carapace width of more than 1.5 inches (38 mm) at the widest dimension during the following situations:

- When participating in a non-CDQ directed fishery for pollock using trawl gear in the BSAI.
- When participating in a directed fishery for pollock

using trawl gear when directed fishing for pollock with non pelagic trawl gear is closed in the GOA.

fish parts that were previously caught and discarded at sea.

BSAI Prohibited Species Donation Program (PSD) §679.26

The operator of a vessel and manager of a shoreside processor must not discard any salmon or transfer or process any salmon under the BSAI salmon PSD program until the number of salmon has been determined by an observer and the collection of any data or samples has been completed.

Operators of vessels and managers of shoreside processors that are required to retain salmon under the PSD program must designate and identify to the NMFS-certified observer a crew person or employee to be responsible for sorting, retention, and storage of salmon. Upon the request of the NMFS-certified observer, the designated crew person or employee is also responsible for counting salmon under the direction of the observer.

Improved Retention/Improved Utilization (IR/IU) §679.27

The owner or operator of a vessel must comply with the IR/IU program set out in this section while fishing for groundfish in the GOA or BSAI, fishing for groundfish in waters of the State of Alaska that are shoreward of the GOA or BSAI, or when processing groundfish harvested in the GOA or BSAI.

The following species are defined as “IR/IU species” for the purposes of this section:

- Pollock (GOA and BSAI)
- Pacific cod (GOA and BSAI)
- Shallow-water flatfish species complex (GOA only)

Product from an IR/IU species may not be discarded at sea, unless such discarding is necessary to meet requirements of this part. If retention is required, any action intended to discard or release an IR/IU species prior to being brought on board the vessel is prohibited. This includes, but is not limited to, bleeding codends and shaking or otherwise removing fish from longline gear.

IR/IU species may be used as bait provided that the deployed bait is physically secured to authorized fishing gear. The retention and utilization requirements do not apply to incidental catch of dead or decomposing fish or

Minimum Retention

For catcher vessels (any gear type):

- If directed fishing for an IR/IU species is open, must retain on board all fish of that species until lawful transfer.
- If directed fishing for an IR/IU species is prohibited, must retain on board all fish of that species up to the maximum retainable amounts (MRA) for that species until lawful transfer.
- If retention of an IR/IU species is prohibited, must retain on board no fish of that species.

For catcher/processors and motherships:

- If directed fishing for an IR/IU species is open, must retain on board a primary product from all fish of that species brought on board until lawful transfer.
- If directed fishing for an IR/IU species is prohibited, must retain on board a primary product from all fish of that species on board the vessel up to the point that the round-weight equivalent of primary products equals the MRA amount for that species until lawful transfer.
- If retention of an IR/IU species is prohibited, must retain on board no fish or product of that species.

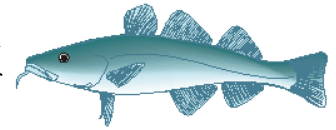

Monitoring Salmon Bycatch in Pollock Fisheries §679.21 and §679.28

Bering Sea Pollock Fishery

Regulations in this section apply to vessels directed fishing for pollock in the BS, including pollock CDQ, and processors taking deliveries from these vessels.

Operators of vessels and managers of shoreside processors and shoreside floating processors (SFP) that are required to retain salmon under paragraph (c)(1) of this section must designate and identify to the observer aboard the vessel, or at the shoreside processor or SFP,

REGULATIONS AND COMPLIANCE: SELECTED REGULATORY REQUIREMENTS

a crew person or employee responsible for ensuring all sorting, retention, and storing of salmon occurs.

CPs and Motherships

Operators of catcher/processors or motherships must sort and transport all salmon bycatch from each haul to an approved storage location adjacent to the observer sampling station. The vessel operator must ensure no salmon of any species pass the observer sample collection point as identified in the scale drawing of the observer sample station. The vessel operator must ensure that the sorting line is attended at all times by vessel personnel. *Any incident of vessel crew leaving the sorting line unattended will result in a potential violation of the requirement to sort all salmon.*

Observers must be allowed free and unobstructed access to the salmon sorting and storage areas. The salmon storage location must remain in view of the observer from the observer sampling station at all times during the sorting of the haul. Your ability to monitor these areas from your sample station may involve the use of one or more cameras viewable on a monitor at your sample station. If one of these cameras fails sorting must stop; document this as a potential violation and contact NMFS.

If, at any point during sorting of the haul or delivery for salmon, the salmon are too numerous to be contained in the salmon storage location, all sorting must cease and the observer must be given the opportunity to count the salmon in the storage location and collect scientific data or biological samples. *Sorting of catch must not resume until all scientific data collection and biological samples are complete.*

Once the observer has completed all counting and sampling duties for the counted salmon, the salmon must be removed by vessel personnel from the approved storage location, in the presence of the observer. Before sorting of the next haul may begin, the observer must be given the opportunity to complete the count of salmon and the collection of scientific data or biological samples from the previous haul.

Electronic Monitoring

The owner or operator of a catcher/processor or a mothership must provide and maintain an electronic monitoring system that includes cameras, a monitor, and a digital video recording system for all areas where sorting of salmon of any species takes place and the

location of the salmon storage container described at paragraph (d)(7) of this section. These electronic monitoring system requirements must be met when the catcher/processor is directed fishing for pollock in the BS, including pollock CDQ, and when the mothership is taking deliveries from catcher vessels directed fishing for pollock in the BS, including pollock CDQ. The video data must be maintained and made available to NMFS staff, or any individual authorized by NMFS, upon request. These data must be retained onboard the vessel for no less than 120 days after the date the video is recorded. The system must provide sufficient resolution and field of view to observe all areas where salmon could be sorted from the catch, all crew actions in these areas, and discern individual fish in the salmon storage container. *The system must be operating at all times when fish are flowing past the sorting area or when salmon are in the storage container; and be securely mounted at or near eye level.* NMFS staff, or any individual authorized by NMFS, must be able to view any earlier footage from any point in the trip and be assisted by crew knowledgeable in the operation of the system.

Catcher Vessels

Operators of Bering Sea pollock catcher vessels delivering to a shoreside processor or stationary floating processor must retain all salmon caught as bycatch. All salmon must be delivered to the processor receiving the vessel's Bering Sea pollock catch and offloaded according to procedures detailed in the processors CMCP. Any unsorted discard at sea from a pollock catcher vessel is a potential violation of the salmon retention requirement.

Shoreside Processors or Stationary Floating Processors

Shoreside processors and stationary floating processors must comply with the Catch Monitoring and Control Plan (CMCP) requirements in §679.28(g)(7)(vii) for the receipt, sorting, and storage of salmon from deliveries of catch from the BS pollock fishery. They also must ensure no salmon of any species pass beyond the last point where sorting of fish occurs, as identified in the scale drawing of the plant in the CMCP. They must sort and transport all salmon of any species to the salmon storage container identified in the CMCP. The salmon must remain in that salmon storage container and within the view of the observer at all times during the offload. If, at any point during the offload, salmon are too numerous to be contained in the salmon storage container, the

offload and all sorting must cease and the observer must count the salmon and collect scientific data or biological samples. The counted salmon then must be removed from the area by plant personnel in the presence of the observer.

Before sorting of the next offload of catch from the BS pollock fishery may begin, the observer must be given the opportunity to complete the count of salmon and the collection of scientific data or biological samples from the previous offload of catch from the BS pollock fishery. *Sorting of catch must not resume until all scientific data collection and biological samples are complete.*

Gulf of Alaska Pollock Fishery

Catcher vessels directed fishing for pollock in the Gulf of Alaska are prohibited from discarding salmon prior to delivery. Shoreside processing plants receiving GOA pollock deliveries are required to sort all salmon from the catch and provide them to the observer for identification, and specimen collection.

Amendment 80 and Bin Monitoring Requirements §679.28 and §679.93

All Amendment 80 vessels fishing for groundfish using trawl gear in the BSAI or GOA must comply with regulatory catch monitoring requirements.

Bin Monitoring requirements as determined in §679.28(i) state that the vessel must comply with bin monitoring Option 1 (limited tank access) unless an alternate bin monitoring option has been inspected and approved by NMFS. Most vessels comply with Option 2 (video bin monitoring) and are required to have on board a current copy of the inspection report and approval letter.

To get approval for a video bin monitoring the vessel owner or operator must make a request to NMFS. The approved bin monitoring option is described in a bin monitoring inspection report approval letter issued from NMFS to the vessel owner or operator. The bin monitoring approval letter is issued once a year and is valid for 12 months from the inspection date. A copy of the approval letter must be retained on board the vessel and made available to the observer upon request.

Failure of Approved Bin Monitoring Option

In the event of bin monitoring equipment alteration or failure the observer must immediately notify their inseason advisor, document the situation in their Daily Notes, and should inform vessel personnel of the

potential issue. Observers may not approve any alternate bin monitoring option contrary to the vessels bin monitoring inspection report approval letter.

The observer(s) should work with their inseason advisor and NMFS staff to clearly identify the problem. If the vessel operator is not able to immediately bring the system back into compliance, the vessel must comply with bin monitoring Option 1. The vessel operator must comply with Option 1 until resumed compliance with the video monitoring approval is determined by NMFS. NMFS staff will determine if the vessel is in compliance with bin monitoring requirements and advise accordingly. It is important that the observer document all potential bin monitoring issues, all communication with to the vessel, and all communications with NMFS staff about the situation.

Regulations Specific to Non-AFA Trawl Catcher/Processors Fishing in the BSAI

Amendment 80 was implemented in 2008. This action allocates several non-pollock trawl groundfish species among fishery sectors in the Bering Sea and Aleutian Islands. Additionally, it facilitates the formation of harvesting cooperatives in the non-AFA trawl catcher/processor sector. Vessels fishing under Amendment 80 regulations are often referred to as Amendment 80 vessels.

All Amendment 80 vessels must meet the following requirements in addition to those described above for CPs:

1. Vessels are prohibited from having more than one operational belt, or other catch conveyance device, between the flow scale and sample collection point.
2. Observers must be able to view all activities inside the bins. There are currently two ways Amendment 80 CPs fishing in the BSAI can satisfy this requirement:
 - **Option 1: Limited tank access** - No crew are allowed inside the bin unless the flow of fish has been stopped between the tank and the sample collection point, all catch has been cleared between these two points, and the observer has been given notice that crew must enter the tank. The observer must be given the opportunity to monitor crew activity in the bin. When informed by the observer that all sample collection activities are completed for the haul, the crew may enter the tank without stopping fish flow

REGULATIONS AND COMPLIANCE: SELECTED REGULATORY REQUIREMENTS

or clearing belts as above.

- **Option 2: Video** - The vessel may use cameras, monitors and a digital recording system to capture activity in all parts of the bin. The observer must be able to monitor bin activity with this system.

Many vessels participating in the Amendment 80 fisheries have chosen the second option, involving installation of video cameras to monitor bin activity. *If Option 2- video fails to meet the standard of allowing the observer to view crew activity in the bin, the vessel must revert to Option 1- limited tank access option.*

3. Retaining unsorted catch on deck outside of the codend without an observer present is prohibited, except in the case that fish is accidentally spilled from the codend during hauling or dumping at which point the fish must be placed in the live bin or back in the codend.
4. Sample stations must be able to contain 10 observer basket's worth of fish at one time. This space may include vertical storage space as well as deck space in addition to space adjacent to the sample station.
5. The vessel participant must provide the opportunity for a pre-cruise meeting. Pre-cruise meetings help to establish:
 - a professional working relationship between the crew and the observer early on in the deployment,
 - clarify what is expected of each participant according to regulations and provide both the vessel crew, and
 - provide the observer the opportunity to discuss specific issues before they become a problem.

Amendment 80 Vessels Subject to BSAI Limits While Fishing in the GOA

Amendment 80 CPs subject to BSAI limits while fishing in the GOA are not restricted by the same regulations as those required in the BSAI. These vessels are not required to have a flow scale, regardless of size or processing facilities onboard. They do not have to carry two observers, offer the opportunity for a pre-cruise meeting or have a certified sampling station.

When fishing in the GOA, Amendment 80 CPs that are subject to BSAI limits must have only one operational sorting line from the fish bins, must have a bin monitoring

system in place (described above), cannot hold fish on deck, and cannot mix hauls.

Currently, there is one catcher processor vessel, the Golden Fleece, exempted from the regulations specific to vessels subject to BSAI limits while fishing in the GOA. The Golden Fleece is required to carry an observer 100% of the time, but does not need to provide a flow scale, certified sample station, pre-cruise meeting, or bin monitoring system. They can hold fish on deck and they can mix hauls.

Regulations Specific to CPs Participating in the Central GOA Rockfish Fishery

CPs participating in the GOA rockfish fishery are subject to the same regulations as those vessels participating in LAPP fisheries in the BSAI. These vessels must have a bin monitoring plan in place, a flow scale, certified observer sampling station, two observers onboard, no mixing of hauls, no catch dumped on deck, etc.

Sampling Stations on Amendment 80 Catcher Processors and AFA Catcher Processors and Motherships

Observer sampling stations for Amendment 80 and AFA CPs and motherships must meet the following requirements (note: additional requirements may be found in Essential Information "Completing the Observer Sampling Station Verification Checklist"):

- Sampling stations must be located within 4 m from the location where you collect unsorted catch.
- Clear unobstructed passage must be provided between the sample collection point and the sampling station. Unobstructed passage means passageways that are at least 65 cm wide, free of tripping hazards, and at least 1.8 m high. While sometimes a sampling station can become a high traffic area or have too many crew members at one time, it is the observer's responsibility to ask them to exit the area until duties have been completed.
- Sampling station must include a table that is at 0.6 m deep, 1.2 m high, and no more than 1.1 m high. The entire surface area of the table must be available to the observer and the table must be secured to the floor or wall.
- Must have a NMFS-approved platform scale with a capacity of at least 50 kg and be located within 1 m of

the table. Vessels usually have backup NMFS-approved platform scales should there be a need for a replacement scale.

- AFA CPs and motherships will have additional requirements for the collection of salmon retention data. These requirements can be found in the “AFA Pollock Catcher Processors, Motherships, and Plants” section on page 12-16.
- Amendment 80 Bin Monitoring requirements can be found on page 20-17.
- Halibut Deck Sorting Sampling Station requirements can also be found on page 20-20

If you have a concern with your sampling station, you should address it with vessel management (captain, mate, data manager, etc.) and communicate the issue to your inseason advisor. The Observer Program should be able to handle most sample station issues by working with vessel companies. Even if you are able to bring about a resolution of a sample station concern before disembarking, you will still be expected to complete a statement documenting the issue. It is important to have documentation of these issues in case they arise again. Enforcement action may be taken if a vessel fails to resolve sample station issues after repeated attempts to work with the vessel.

Halibut Deck Sorting Monitoring Requirements for Trawl Catcher Processors and Motherships Operating in Non-Pollock Groundfish Fisheries off Alaska §679.120

The halibut deck sorting regulatory program was implemented in 2020 after several years of exempted fishing permits. These regulations apply to trawl catcher processors targeting non-pollock groundfish species in the Bering Sea, Gulf of Alaska, and Aleutian Islands Management Area. The halibut deck sorting regulations essentially allow a prohibited species to be sorted from catch in a way that facilitates unbiased, high quality data collection. Therefore, it is important that the vessel meets the following conditions in order to participate in halibut deck sorting.

Catch weighing:

All catch, with the exception of deck sorted halibut, must be weighed on a NMFS-approved scale. Hauls must be weighed separately, all catch must be accessible

for sampling by an observer, and no sorting of catch, except halibut sorted on deck, may take place prior to weighing. No fish may be weighed while deck sorting unless two observers are available for collecting data - one on deck and one in the factory. A visual signal must be employed to indicate when catch is not to be weighed on the NMFS-approved scale.

Safe conditions for halibut deck sorting

The vessel is required to provide assigned observers a certified Deck Safety Plan and a Deck Safety Meeting. It is crucial that observers use these tools as a way to evaluate whether the vessel is providing safe working conditions for halibut deck sorting. Safety is an observer’s number one priority. Deck Safety Plans and Deck Safety Meetings are also discussed on page 5-36.

Under 50 CFR 679.120(d)(1) deck safety plans must:

- Describe the route for observers to safely access and leave the deck sampling station and specify locations where observers may shelter during gear retrieval and movement.
- Describe hazardous areas and potentially hazardous conditions that could be encountered on deck.
- Describe communications procedures to inform the observer when it is safe to access the deck. These procedures must identify who will tell the observer it is safe to access the deck, how that communication will happen, and how they will communicate with the observer if a new safety hazard arises while on deck.
- List personal protective equipment that must be worn by the observer while on deck.
- List all personnel the observer may contact to report safety issues, including safety hazards identified by the observer that are not covered by the Deck Safety Plan, deviations from the Deck Safety Plan, and any conditions that would require the suspension of halibut deck sorting.
- Provide procedures to ensure the observer’s safety while working in the deck sampling station.
- Include a scale drawing showing the deck sampling station, the routes to access and exit the deck sampling station, emergency muster location, and safety hazards that could be encountered on deck.

REGULATIONS AND COMPLIANCE: SELECTED REGULATORY REQUIREMENTS

Pre-cruise Requirement

50 CFR 679.120(c) - Notify the Observer Program by phone at least 24 hours prior to departure when the vessel will be carrying an observer who has not previously been deployed on that vessel within the last 12 months. Subsequent to the vessel's departure notification, but prior to departure, NMFS may contact the vessel to arrange for a pre-cruise meeting. The pre-cruise meeting must minimally include the vessel operator or manager and any observers assigned to the vessel.

Video Monitoring Requirement

50 CFR 679.28(l) - The owner and operator of a mothership or catcher/processor subject to § 679.120 must provide and maintain a video monitoring system approved under paragraph (e) of this section when the vessel is halibut deck sorting. Additionally, the system must:

1. Record and retain video for an entire trip when halibut deck sorting may occur; and
2. Provide sufficient resolution and field of view to monitor all areas on deck where halibut may be sorted from the catch and discarded.

It is the vessel operator's responsibility to inform the observers in the event of a video monitoring malfunction. In the event of a malfunction, the vessel must cease deck sorting until video monitoring is functional. The vessel may continue to fish without deck sorting.

Vessel Responsibilities {§679.120(e)} and Prohibitions {§679.7(e)}

Requirements for time limit, notification, sorting pace, and visual signal are described in Trawl Composition Chapter 5. In addition to these requirements, the vessel must:

- Conduct halibut deck sorting only when an observer is present at the deck sampling station.
- Handle all halibut sorted on deck with a minimum of injury.
- Not sort or discard any species other than halibut during deck sorting. This includes mud balls or rocks that organisms may live upon or within, but excludes trash and fishing gear.

Observer Deck Sampling Stations

Halibut deck sorting sample stations must meet the following requirements (note: additional requirements may be found in Essential Information "Completing the Halibut Deck Sorting Sample Station Verification Checklist"):

1. Located near a point of discard.
2. Have a table with the following criteria:
 - Is at least 0.6 m deep, 1.2 m wide, and 0.9 m high (but no higher than 1.1 m).
 - The entire surface area must be available for use by the observer.
 - Is secured to the deck.
 - Constructed to prevent fish from sliding off.
3. Have one single sorting pathway through which all halibut pass through the sample station. This single point of discard of discard must be visible to the observer. Halibut too large to be put on table may be measured on deck.

If you have a concern with your deck sorting sample station, you should address it with vessel management (captain, mate, data manager, etc.) and communicate the issue to your inseason advisor. The Observer Program should be able to handle most sample station issues by working with vessel companies. Even if you are able to bring about a resolution of a sample station concern before disembarking, you will still be expected to complete a statement documenting the issue. It is important to have documentation of these issues in case they arise again. Enforcement action may be taken if a vessel fails to resolve sample station issues after repeated attempts to work with the vessel.

General Video Monitoring Requirements {§679.28(e)}

Video monitoring is required on LAPP trawlers and motherships (AFA and A80) as well as Catcher Processor Longliners. The purpose of this section is to lay out general video monitoring system requirements. See the following pages for more specific information regarding video monitoring on different vessels/gear types:

- Amendment 91 Salmon: Page 12-17
- Amendment 80 Bin Monitoring (Option 2): Page 20-18

- Halibut Deck Sorting: Pages 5-37 and 20-20
- Longline CP: Page 8-23

Each vessel's video monitoring system must have sufficient data storage capacity for storing all video footage from an entire trip. The system must also record a time and date stamp with the Alaska local time. In addition:

1. The system must have at least one external USB port or other removable storage device approved by NMFS.
2. The video data must be maintained by the vessel operator and made available on request by NMFS employees, or other agency staff authorized by NMFS.
3. The data must be retained on board the vessel for no less than 120 days after the date the video is recorded, unless notified otherwise.
4. When the video monitoring system is required to be in use, the system must record at a speed of no less than 5 frames per second.

While these regulations are crucial for system operation and compliance, observers are not likely to witness potential violations related to the above unless reported by the vessel operator or other crew tasked with maintaining the system. Observers should document these reports as well as any system-wide outages, individual camera failures, failures in the sample station monitor, or any issues with the recording of footage.

Sample station monitors are only required on CP trawlers and motherships operating in the AFA and Amendment 80 fisheries. Monitors must:

1. Show footage in color and have the capacity to display all camera views simultaneously.
2. Be securely mounted at or near eye level.
3. Always be operating when the video monitoring system is required:
 - Amendment 80- Video monitoring system is required to be operational for bin monitoring at all periods when fish are inside the bin.
 - AFA - Video monitoring system is required to be operational (recording and retaining video) at all periods when fish are flowing past the sorting area

or salmon are in the storage container.

- Halibut Deck Sorting - Video monitoring system is required to be operational for an entire trip when halibut deck sorting occurs.

Video Monitoring Inspections

The vessel operator must maintain a current NMFS-issued Video Monitoring System Inspection Report on board the vessel. This report is required to be provided to observers upon request and must contain a diagram drawn to scale that shows all sorting locations, the MCP scale location, the location of each camera and the area it covers. For CPs and motherships in the BSAI pollock fishery the diagram must include the salmon storage container. Observers should request the video monitoring inspection report upon embarking the vessel; vessel management is required to provide all inspection reports to observers upon request.

Seabird Avoidance Gear and Methods for Longliners §679.24

Seabird avoidance measures apply to the operators of vessels >26 feet Length Over All (LOA) using hook-and-line gear as follows:



1. IFQ and CDQ Pacific halibut
2. IFQ sablefish
3. Groundfish in the U.S. EEZ waters off Alaska (3-200 nm)

Vessels required to use seabird avoidance gear must use avoidance gear at all times while gear is being set or deployed. Streamer lines or buoy bags of specified performance and materials standards must be used in accordance with Figure 20-3.

When two streamer lines are required for stern setting vessels they must be deployed one on each side of the main groundline. The streamer lines will be deployed prior to the first hook being set. At least one streamer line must be deployed before the first hook is set and both streamers must be fully deployed within 90 seconds.

An exception to these requirements would exist in conditions of wind speeds exceeding 30 knots, where it would be acceptable to fly a single streamer from the windward side of the vessel. In winds exceeding 45 knots, the deployment of streamer lines are discretionary. If

REGULATIONS AND COMPLIANCE: SELECTED REGULATORY REQUIREMENTS

you suspect a violation, record the wind speed in knots if possible and/or the “Beaufort Sea State Descriptions” on page 16-17.

| If a vessel deploying hook-and-line gear, in waters specified at §679.24(e)(3), and the vessel is.... | then the vessel must use this seabird avoidance gear in conjunction with requirements at §679.24(e)... |
|--|---|
| > 26 ft to 55 ft LOA and without masts, poles, or rigging | minimum of one buoy bag line |
| > 26 ft to 55 ft LOA and with masts, poles, or rigging* | minimum of a single streamer line of a standard specified at § 679.24(e)(4)(ii) |
| > 55 ft LOA* | minimum of a paired streamer lines of a standard specified at § 679.24(e)(4)(iii) |
| *Vessels using snap gear deploy seabird avoidance gear of a standard specified at § 679.24(e)(4)(iv). Vessels >55 ft LOA using snap-gear are required to deploy a minimum of a single streamer line. | |

Figure 20-3: Vessel Bird Deterrent Requirements

Streamer Line Specifications for Vessels Not Using Snap-Gear:

1. Streamer lines must be a minimum of 300 ft long.
2. Streamers must be spaced every 16.4 ft.
3. Streamers must be of brightly colored plastic tubing, polyester line or material of an equivalent density.
4. Individual streamers must hang to 0.25 m above the waterline in the absence of wind.

Additional Seabird Avoidance Requirements for all Vessels:

1. Directed discharge (through chutes, pipes, or other similar devices) of residual bait or offal from the stern of the vessel while setting gear is prohibited.
2. Embedded hooks must be removed from offal discharge
3. If offal is discharged while gear is being hauled, it must be in a manner which detracts seabirds from baited hooks - either aft of, or on the opposite side of,

the hauling station.

4. Crew must make every reasonable effort to ensure birds brought on board alive are released alive and that, wherever possible, hooks are removed without jeopardizing the life of the birds.
5. Make seabird avoidance gear available for inspection, if requested by an observer.



Always record weather and sea conditions if you witness or suspect a seabird avoidance gear violation.

Shark Finning §600.1203

The Magnuson Act prohibits the act of shark finning. Shark finning is defined as “taking a shark, removing a fin or fins, and returning the remainder of the shark to the sea”. It is illegal to remove a shark’s fin at sea, and possess, land, or transfer shark fins at sea without the corresponding carcass.

Marine Mammals §216 and §229

Definitions §216.3

Marine mammal means those specimens of the following orders, which are morphologically adapted to the marine environment, and whether alive or dead, and any parts thereof, including but not limited to, any raw dressed or dyed fur or skin: Cetacea (whales and porpoises), Pinnipedia (seals and sea lions), other than walrus.

Take means to harass, hunt, capture, collect, or kill, or attempt to harass, hunt, capture, collect, or kill, any marine mammal. This includes, without limitation, any of the following:

- The collection of dead animals, or parts thereof; the restraint or detention of a marine mammal, no matter how temporary;
- tagging a marine mammal;
- the negligent or intentional operation of aircraft or vessel, feeding or attempting to feed a marine mammal in the wild, or the doing of other negligent or intentional acts which result in the disturbing or molesting of a marine mammal.

Feeding is defined as “offering, giving, or attempting to give food or nonfood items to marine mammals in the wild. It includes operating a vessel or providing other

platforms from which feeding is conducted or supported. It does not include the routine discard of bycatch during fishing operations or the routine discharge of waste or fish by-products from fish processing plants or other platforms if the discharge is otherwise legal and is incidental to operation of the activity.”



It is unlawful and harmful to intentionally feed or attempt to feed any marine mammal in the wild.

Prohibited Uses, Possession, Transportation, and Sales §216.13

It is unlawful for:

- Any person to use any port, harbor or other place under the jurisdiction of the United States for any purpose in any way connected with the prohibited taking or unlawful importation of any marine mammal or marine mammal product; or
- Any person subject to the jurisdiction of the United States to possess any marine mammal taken in violation of the MMPA or these regulations, or to transport, sell, or offer for sale any such marine mammal product made from any such marine mammal.

Collection of Certain Marine Mammal Parts §216.26

- Bones, teeth or ivory (hard parts) of marine mammals may be collected from a beach or from land within 1/4 of a mile of the ocean. (*NOTE: The Endangered Species Act contains additional restrictions prohibiting the collection of endangered species parts.*)
- Unless authorized by exemption, no person may collect or retain any part of a marine mammal that is retrieved in the commercial fishing gear. (*NOTE: Observers are not authorized to collect walrus parts from fishing gear.*)
- No person may purchase, sell, or trade for commercial purpose any marine mammal part collected or imported under this section.

Marine Mammal Fishery Interaction Regulations §229

Except as noted below, it is unlawful to take any marine mammal incidental to commercial fishing operations.

In addition, it is unlawful to (1) take any California sea otter; or (2) intentionally lethally take any Steller sea lion, any Alaskan sea otter, any cetacean, any depleted species (including the Pribilof Island population of Northern fur seal), or any endangered or threatened marine mammal. If the use of firearms or other means to deter marine mammals results in an injury or mortality of a marine mammal, the taking is presumed to be intentional lethal taking.

- Marine mammals killed during fishing operations which are readily accessible to crew members must be brought aboard the vessel for biological processing, if feasible and if requested by the observer. Marine mammals designated as biological specimens by the observer must be retained in cold storage aboard the vessel, if feasible, until retrieved by authorized NMFS personnel.
- Any marine mammal incidentally taken must be immediately returned to the sea with a minimum of further injury and may only be retained if authorized by an observer, by condition of the Exemption Certificate, or by a scientific research permit in possession of the operator.

Reporting Requirements §229

Vessel owners or operators engaged in any commercial fishery must report all incidental mortality and injury of marine mammals in the course of commercial fishing operations to the Assistant Administrator appropriate Regional Office, by mail or other such as fax or overnight mail specified by the Administrator. Reports must be sent within 48 hours after the end of each fishing trip during which the incidental mortality or injury occurred, or, for non- vessel fisheries, within 48 hours of an occurrence of an incidental mortality or injury. *An observer’s report to NMFS does not replace this notification requirement! Please note that it is prohibited for any person to provide false information to an observer regarding a marine mammal take.*

Steller Sea Lions §679.22 and §223.202

These regulations apply to all human activities, including commercial fishing, near Steller (northern) sea lions at-sea and near some of the islands where they breed.



REGULATIONS AND COMPLIANCE: OBSERVER PROCEDURES DURING COAST GUARD BOARDING

- Shooting at or near any Steller sea lion for any reason is prohibited in U.S. waters. Fishermen may use other means which do not result in injury or death to the animal to deter sea lions from interfering with their gear.
- Fishing vessels are not permitted to enter within 3 nautical miles of Steller sea lion rookery sites west of 150° W longitude. Trawling cannot be conducted within 10 nautical miles of Steller sea lion rookery sites during any part of the year. Trawling cannot be conducted within 20 nautical miles of the rookeries on Akun, Akutan, Sea Lion Rock, Ugamak, Seguam, and Agligadak rookeries from January 20 to April 15.
- This section does not prohibit a vessel in transit from passing through listed straits, narrows, or passageways, if the vessel proceeds in a continuous transit and maintains a minimum of 1 nautical mile from the rookery site. Longline and pot vessels may fish within the 10 and 20 mile boundaries, but may not enter inside of 3 nautical miles. Detailed maps and lists of these areas are available from NMFS in Juneau or on the web at <http://www.fakr.noaa.gov>.

Humpback Whales §223.214

It is unlawful for any person to attempt to commit, to solicit another to commit, or to cause to be committed, within 200 nautical miles of Alaska, or within inland waters of the state, any of the following with respect to threatened Humpback whales (*Megaptera novaeangliae*):

- Approach, by any means, within 100 yards of any humpback whale.
- Cause a vessel or other object to approach within 100 yards of a humpback whale.
- Disrupt the normal behavior or prior activity of a whale by any other act or omission. A disruption of normal behavior may be manifested by: a rapid change in direction or speed; escape tactics such as prolonged diving, underwater course changes, underwater exhalation, or evasive swimming patterns; interruptions of breeding, nursing, or resting activities, attempts by a whale to shield a calf.

The above do not apply to commercial fishing vessels lawfully engaged in actively setting, retrieving, or closely tending commercial fishing gear. When the vessel is not performing these operations, it is crucial for

observers to be aware of and document any humpback whale approaches.

OBSERVER PROCEDURES DURING COAST GUARD BOARDING

The U.S. Coast Guard (USCG) makes periodic boardings of fishing vessels to check for fisheries and safety violations. If the Coast Guard boards your vessel, introduce yourself. After that, remain in the background and let the boarding party know



where you can be found. Do not join in any discussions between boarding party members and vessel personnel. The Coast Guard or NMFS agent has certain objectives to accomplish in every boarding. If your assistance is needed, they will ask for it. If the boarding party has questions or requests your assistance, be cooperative. Most Coast Guard officers are not biologists and you may be of assistance in identifying species of fish and invertebrates in bins, processing areas or freezer holds.

Make sure your logbook and paperwork are in order in case the boarding party wishes to inspect them. ***Do not give away your original forms or your logbook!*** Make copies as needed. If your vessel does not have a copy machine ask if copies can be made on board the Coast Guard vessel. If this is not a possibility, the Coast Guard may make handwritten copies or you may refer them to the Observer Program for copies of inseason data.

If you have information on suspected or actual violations, or other problems, you may or may not wish to relay them to the boarding party. Use your judgment to decide if a potential violation would best be reported to the boarding party or saved for debriefing. If a vessel is issued a ticket immediately based on your report, you may be in an awkward position after the Coast Guard leaves. The Coast Guard is aware that observers may or may not choose to advise them of witnessed violations dependent on the situation.

If you have no information for the boarding party but someone in the boarding party wishes to question you, find a private location for your conversation. On occasion, an uninformed boarding party member may ask you questions in front of vessel personnel. Should this happen, defer the questions until you can speak in private. If that doesn't work, ask if they will accept

a written statement from you. If you are questioned in private, answer all questions completely and honestly.

Your role in a Coast Guard boarding is as a source of objective information for the boarding party. The boarding party will conduct their own inspections and investigations, and they may or may not require your assistance. You should cooperate fully, and not hamper the investigation.

During a Coast Guard boarding, bag searches may also occur, if there are any problems please contact NMFS and your observer provider.

Coast Guard Role in Homeland Security

The U.S. Coast Guard is required to obtain information on all vessels that could transport foreign nationals into the country. Fishing vessels fall into this category as they hire crew from many different nationalities. When applicable, the master of a fishing vessel is required to submit to the Coast Guard a Notice of Arrival and Departure (NOAD) which includes information of each crew member and passenger. This information may include but it is not limited to the personal information documented on a Real ID (name, DOB, nationality etc), and each person's role on the vessel. You are required to have your Real ID all times while on board a vessel. If the master of the vessel requests to see your Real ID, you must present it for verification. Your observer badge may be used to verify your position on the boat, however, your observer badge is not a substitute for a Real ID.



Passports are a form of Real ID that help to limit access to your personal information when complying with a lawful request for identification.

Transportation Workers Identification Credentials (TWIC)

Certain ports and facilities require an additional level of identification and security clearance known as a TWIC (Transportation Workers Identification Credentials) card for unescorted access. If you are asked for a TWIC card when accessing areas to board your vessel, present your observer ID badge and accept an escort. If you have problems contact any Observer Program staff member for assistance.

Observer Health and Safety §600.746

An observer is not required to board, or stay aboard, a vessel that is unsafe or inadequate as described in this section.



A vessel is considered inadequate or unsafe for purposes of carrying an observer and allowing operation of normal observer functions if it does not comply with the applicable regulations regarding observer accommodations or if it has not passed or would not pass a USCG safety examination or inspection.

A vessel that has passed a USCG safety examination or inspection must display one of the following:

- A current Commercial Fishing Vessel Safety Examination decal, issued within the last 2 years.
- A certificate of compliance issued pursuant to 46 CFR 28.710; or
- A valid certificate of inspection pursuant to 46 U.S.C. 3311.
- Upon request by an observer, a NMFS employee, or a designated observer provider, a vessel owner/operator must provide correct information concerning any item relating to any safety or accommodation requirement prescribed by law or regulation. A vessel owner or operator must also allow an observer, a NMFS employee, or a designated observer provider to visually examine any such item.

Safety Orientation

Prior to operating the vessel, the master must ensure a safety orientation is provided to anyone who has not received the required instruction or participated in the drills. Never get underway on a vessel for the first time without first receiving a safety orientation. If the captain will not provide you with an orientation before leaving the dock you must disembark the vessel. It is not appropriate to receive the orientation after departing. Refer to the [Federal Requirements for Commercial Fishing Industry Vessels](#) for more detailed safety regulations.

Prior to each observed trip, the observer is encouraged to briefly walk through the vessel's major spaces to ensure that no obviously hazardous conditions exist. More information on vessel safety and a detailed safety

REGULATIONS AND COMPLIANCE: MARINE POLLUTION (MARPOL) REGULATIONS

checklist can be found in the Health and Safety chapter, beginning on page 19-1.

Corrective Measures

If a vessel is inadequate or unsafe for purposes of carrying an observer and allowing operation of normal observer functions, NMFS may require the vessel owner or operator either to:

- Submit to and pass a USCG safety examination or inspection; or
- Correct the deficiency that is rendering the vessel inadequate or unsafe before the vessel is boarded by the observer.

The requirements of this section apply both at the time of the observer's boarding, at all times the observer is aboard, and at the time the observer is disembarking from the vessel.

A vessel that would otherwise be required to carry an observer, but is inadequate or unsafe for purposes of carrying an observer and for allowing operation of normal observer functions, is prohibited from fishing without observer coverage.

MARINE POLLUTION (MARPOL) REGULATIONS

The International Convention for the Prevention of Pollution From Ships (MARPOL) and five annexes are international agreements that were designed to halt at-sea disposal of wastes. MARPOL Annex V specifically prohibits the at-sea disposal of all plastics. It also eliminates the discharge of garbage into the sea. Garbage means all kinds of food wastes, domestic wastes and operational wastes, all plastics, cargo residues, cooking oil, fishing gear, and animal carcasses generated during the normal operation of the ship and liable to be disposed of continuously or periodically except those substances which are defined or listed in other Annexes to the present Convention.

Under prescribed conditions, there are exceptions for food wastes, cargo residues, cleaning agents or additives contained in cargo hold, deck, and external surface wash waters, and animal carcasses. The at-sea disposal restrictions apply to commercial and publicly owned vessels of all sizes and classes.



Garbage does not include fresh fish and parts thereof generated as a result of fishing activities undertaken during the voyage, or as a result of aquaculture activities which involve the transport of fish including shellfish for placement in the aquaculture facility and the transport of harvested fish including shellfish from such facilities to shore for processing.

Plastic debris has been a concern of the NMFS since the early 1980's. Studies conducted in the North Pacific have linked debris generated by commercial ground fishing vessels with detrimental impacts to fish, seabirds, and marine mammals. Fur seals and Steller sea lions have been shown to be vulnerable to entanglement in netting, rope, and packing strap discards. Entanglement in debris is thought to contribute to mortality of individuals through starvation, suffocation, infection in resulting wounds, exhaustion, bleeding, drowning, and possibly increased predation. Studies conducted by the NMFS, Marine Mammal Laboratory indicate entanglement may be contributing to the decline in northern fur seal population. In addition to entanglement in netting and plastic wastes, other species are also affected by ingestion. Stomach analysis of some seabirds and fish have found indigestible plastics.

Vessel Operator Obligations

Regulations require U.S. recreational and other vessel operators, if their vessel is 26 feet or more in length, to affix one or more placards to their vessel. These placards warn against the discharge of plastic and other forms of garbage within the navigable waters of the United States, and specify discharge restrictions beyond three miles from shore. The placard must also note that State and local regulations may further restrict the disposal of garbage.

Placards

Operators shall ensure that one or more placards are displayed in prominent locations and in sufficient numbers so that they can be observed and read by the crew and passengers. Each placard must be at least 9 inches wide and 4 inches high, made of durable material, and lettered with letters at least 1/8 inch high.

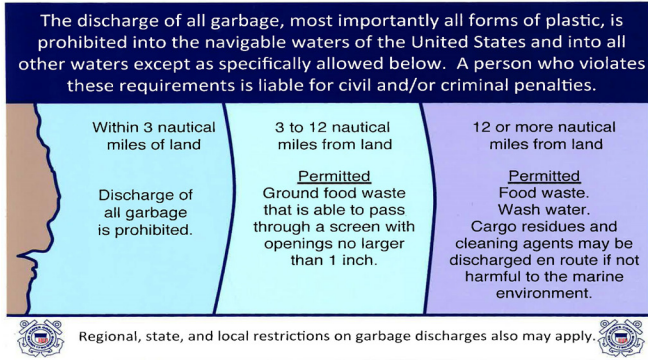

Waste Management Plans

The regulations require U.S. recreational and other vessel operators, if their vessel is 40 feet or more in length and engaged in commerce or equipped with a galley and berthing, to carry a Waste Management Plan if the vessel operates, or is certified to operate, beyond three nautical miles from shore.

The Waste Management Plan must be in writing and describe procedures for collecting, processing, storing, and properly disposing of garbage in a way that will not violate regulatory requirements. It must also designate the person who is in charge of carrying out the plan.

Marina Obligations

Ports and terminals that conduct business with a commercial vessel must be capable of receiving garbage from the vessel when it docks. Recreational boating facilities, capable of providing wharfage or other services for ten or more recreational vessels, must also provide adequate garbage reception facilities for any vessel that routinely calls. If a marina or terminal does not want to be directly involved in garbage collection and disposal, local firms may be retained to provide the service at the marina or terminal. Vessels must be conducting business with the facility or marina in order to qualify for the service. Terminals and marinas would not be expected to provide reception services to a vessel whose sole reason for docking was to offload its garbage. The marina or terminal can charge vessel operators reasonable fees for providing the reception service.

Reporting Violations

Vessels denied the ability to offload their garbage wastes at marinas or other terminals should contact the closest U.S. Coast Guard Captain of The Port or Marine Safety Office. Any US citizen may report observations of

dumping in violation of Annex V at these same offices. NOTE: Observers reporting a potential MARPOL V violation will complete a written statement during the debriefing process.

FEDERAL REQUIREMENTS FOR COMMERCIAL FISHING INDUSTRY VESSELS

Federal Requirements for Commercial Fishing Industry Vessels is published by the U.S. Coast Guard and contains pertinent safety information regarding your assigned fishing vessel. Reference this pamphlet when you have questions regarding a vessel’s safety requirements. Contact your employer and the Observer Program if you have questions regarding safety equipment. Document any potential violations of the safety requirements. A copy will be provided to you in training or briefing, and is also available on line at: http://www.fishsafewest.info/PDFs/FedReqPamphlet_%20Sep2020.pdf

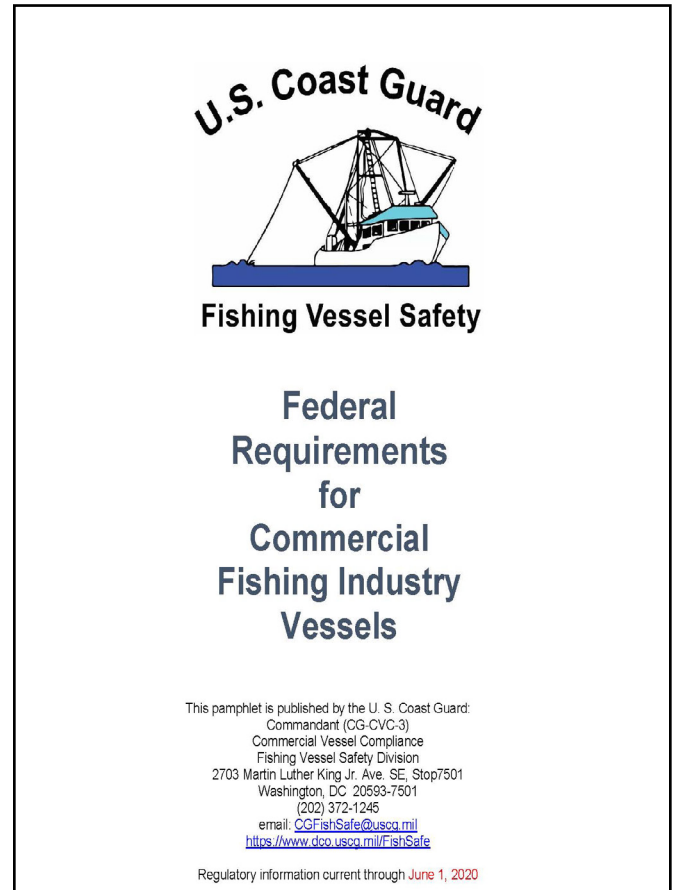

Figure 20-4: Federal Requirements for Commercial Fishing Industry Vessels pamphlet cover

This page intentionally left blank.

INSEASON ADVISING, MID-CRUISE AND FINAL DEBRIEFING



Table Of Contents

| | |
|--|-------|
| Priorities | 21-1 |
| At Sea Preparation | 21-1 |
| Reviewing Data for Errors | 21-2 |
| Forms Required by Assignment | 21-3 |
| Inseason Advising | 21-5 |
| Inseason Advisors | 21-5 |
| Inseason Messages | 21-5 |
| Observers Responsibilities | 21-5 |
| Inseason Advisor Responsibilities | 21-6 |
| Inseason Questions and Messages | 21-6 |
| Mid-Cruise Debriefing | 21-7 |
| Final Debriefing | 21-9 |
| Scheduling and Check-in Tasks | 21-10 |
| Submitting Data | 21-10 |
| Reviewing Forms for Errors Prior to Debriefing | 21-10 |
| Vessel Survey | 21-11 |
| Interview | 21-11 |
| Gear Check In | 21-11 |
| Evaluations | 21-11 |

PRIORITIES

- Maintain communication with your inseason advisor.
- Schedule a mid-cruise meeting if required.
- Complete, organize and prepare all your data and specimens for final debriefing. Provide your data to NMFS as requested.
- Schedule a final debriefing through your employer.
- Complete a vessel survey for each vessel of your deployment.
- Partial Coverage sector deployments: complete a vessel survey after each assignment and submit the “Post-Trip Questionnaire” to your inseason advisor as requested.
- Complete a final debriefing interview with Observer Program staff.
- Complete any needed corrections and resubmit your data.
- Turn-in your PLB.
- Clean and turn-in or refresh your sampling and safety gear.

INTRODUCTION

To ensure scientifically valid methods and sound data, the Observer Program requires that observers communicate with an inseason advisor if assigned one, and participate in both a mid-cruise, if required, and a final debriefing.

The mid-cruise debriefing will assess your work while in the field. Following your cruise, you will participate in a “final debriefing” with an Observer Program staff member and prepare a final report for each vessel assignment. A conscientious attitude towards collecting quality data and good communication with your inseason advisor will expedite the debriefing process.

At Sea Preparation

The final debriefing does not take place until the end of your last assignment, but there are many things you can do to prepare for this process. This section provides guidance on how to check and organize your data. *Reading and following this section while at sea will simplify and expedite your debriefing.*

Data check: While you are at sea, check your data on a regular basis. Consult your manual continuously while doing paperwork and be sure the data are reported following all pertinent protocols as outlined

in this manual. The examples in the manual represent a complete “set” of data and show how data are interlinked as well as the correct format for reporting each. Please see Figure 21-1 for forms required by assignment.

Inseason communication: Work with your inseason advisor to improve and assure data quality. If you do not have an inseason advisor, or need more assistance you may stop in to field offices for data reports.

Mid-cruise: Schedule a mid-cruise debriefing with Observer Program staff after completing a few trips.

Logbook: Maintaining entries in your logbook while deployed is a requirement. See “Observer Logbook Entries” on page 2-16 for specific information on logbook entries.

Observers who have witnessed potential fisheries violations may be instructed during debriefing to complete a written statement describing the event. Refer to “Reporting Potential Violations” on page 20-2 for more information.

Reviewing Data for Errors

An important step in your success as an observer is to double check your data to assure quality. Double checking your work on a regular basis (while deployed) will improve data quality, demonstrate professionalism, and expedite the debriefing process. If you make it to a field office, you can request assistance with your data checking responsibilities and duties from field staff personnel. Keep in mind the field offices are busy so Observer Program staff will assist you depending on time available.

Follow the guidelines below when reviewing your data for errors. These lists are not all inclusive.

Check All Data Forms For:

- Your name and vessel name on all pages of each form type.
- Pages numbered properly, no skipped or duplicate numbers.
- Every page has your cruise number and vessel permit.
- Leading zeros are present only for dates, times, and position minutes and seconds.
- All fields with pre-printed decimals have numbers

listed to two decimal places.

- Your handwriting is legible.

Trawlers

Check Trip Form For:

- All trips closed out with end date/times/port.
- All trips on trawlers should have bait code-9.

Check Vessel and Observer Haul Forms For:

- Every day assigned to the vessel has an entry. This includes the day you boarded and disembarked.
- Non-fishing days have a non-fishing position with a haul number of zero; notes are made in the logbook or on the VHF regarding the reason the vessel was not fishing.
- Hauls are ordered by date of retrieval.
- No duplicate haul numbers.
- No decimals other than those pre-printed on the page.
- For motherships, full name of catcher boat and the ADF&G #s are completed in box at top of page.
- For each delivery to a mothership, the delivering catcher boat’s ADF&G# is recorded.

Check Vessel Haul Form For:

- The Purpose Code is completed correctly. Catch Accounting (CA) is the default unless your vessel has an Experimental Fishing Permit (EFP).
- Deployment and retrieval positions are recorded for all hauls. Degree, minute and second entries must be two digits.
- Positions have no minutes or seconds greater than 59. Gear deployment and gear retrieval times between hauls do not overlap (except on motherships).
- Retrieval times of 0000 are attributed to the next day.
- Depths are rounded to whole numbers and fishing depths are never deeper than bottom depths.
- “F” or “M” is recorded for every depth recorded.
- An entry is recorded in the IFQ column.

| Paper Forms | ATLAS | |
|---|---|---|
| | Vessels | Plants |
| Trip Data Form | YES | Not completed at plants |
| Vessel Haul Form | YES | Not completed at plants |
| Observer Haul Form | YES | Not completed at plants |
| Plant/Vessel Offload Form | CVs only | YES |
| Raw Data Deck Forms | Yes | Yes |
| Marine Mammal Sighting Form | Paper form only | Paper form only |
| Bird Interaction, Activity and Species Form | No (Paper form required for short-tailed albatross only) | No (Paper form required for short-tailed albatross only) |
| Bird Specimen and Tag Information Form | No (Paper form required for short-tailed albatross only) | No (Paper form required for short-tailed albatross only) |
| Species ID Form | Yes | Yes |
| Research Project Forms, Tagged Fish Forms | Yes | Yes |

Figure 21-1: Forms Required by Assignment

- CDQ numbers are recorded with the letter “C” followed by the two digits of the CDQ group number (found in the vessel logbook and on page 4-17).

- No time recorded for non-fishing days.

Check Observer Haul Form For:

- If discards are unknown, the field is left blank; if discards are zero, a value of zero is entered. All CV pollock hauls must have an estimate of discard whether sampled or not.
- Sample Design and Sample Unit Type are complete and accurate for each sampled haul and match survey details.
- A vessel estimate entry exists for every haul.
- Entry of 0 is recorded under “haul number” for non-fishing days.

Check Plant/Vessel Offload Form (CV Vessels) For:

- Plant/processor name, and processor permit #'s are completed in the box at the top left hand side of the page.
- Landing Report ID # recorded exactly as shown on the fish ticket.

- Entries for plant observers are left blank.

- Entries for Total Delivered are entered to the whole kilogram or pound.

Check Marine Mammal Sighting Form For:

- Make sure all the non-shaded boxes are complete, including cruise # and vessel permit.
- Identifying characteristics are described in detail.
- For repeated sightings on the same day, you have at least one sighting form per day.

Longliner and Pot Vessels

Check Trip Form For:

- All trips closed out with end date/times/port.
- All trips on should have bait code. If no fishing occurred, used bait code-9.

Check Vessel and Observer Haul Forms For:

- Set data are recorded in order of retrieval date.
- Each day on the vessel has an entry including the day you boarded, disembarked and all days in between (including non-fishing days).
- Non-fishing days have a non-fishing position with a set

number of zero.

- No duplicate set numbers.
- No decimals other than those pre-printed on the page.

Check Vessel Haul Form For:

- The Purpose Code is completed correctly. Catch Accounting (CA) is the default unless your vessel has an Experimental Fishing Permit (EFP).
- Set and retrieval positions are recorded for all sets. Degree, minute and second entries must be two digits.
- Positions have no minutes or seconds greater than 59.
- Positions recorded to seconds are properly converted.
- Retrieval times of 0000 are attributed to the next day.
- Depths are rounded to whole numbers and only “average bottom depth” column has entries.
- “F” or “M” is recorded for every depth recorded.
- “Y” or “N” is recorded in the IFQ column.
- CDQ numbers are recorded with the letter “C” followed by the two digits of the CDQ group number (found in the vessel logbook).
- Gear type is 6 for pot vessels and 8 for longline vessels.

Check Observer Haul Form For:

- Sample Design and Sample Unit Type are complete and accurate for each sampled haul.
- Sampled hauls discard weight is entered.
- All hauls, vessel estimate is entered.
- Number of segments and Hook Collection # entered for every haul (longline only).
- Total number of hooks in a set entries are rounded to 2 decimal places (longline only).
- For all hauls, the total pots or # of segments in a set is entered. Lost gear should not be included.
- Flow scale weight is recorded for all Longline CPs.

Check Hook Count and Spacing Form (Longline Vessels)

For:

- No duplicate Collection Numbers.
- Segment numbers within each collection do not repeat.
- The date the count was completed is recorded for each collection.
- If on an IFQ/CDQ sablefish vessel, the hook spacing information is complete.

Check Plant/Vessel Offload Form (CV Vessels) For:

- Plant/processor name, and processor permit #'s are completed in the box at the top left hand side of the page.
- Landing Report ID # recorded exactly as shown on the fish ticket.
- Entries for plant observers are left blank.
- Entries for Total Delivered are entered to the whole kilogram or pound.

Check Marine Mammal Sighting Form For:

- Make sure all the non-shaded boxes are complete, including cruise # and vessel permit.
- Identifying characteristics are described in detail.
- For repeated sightings on the same day, you have at least one sighting form per day.

Plants

Check Plant/Vessel Offload Form For:

- All mandatory information is on the forms. If information is missing, explain the circumstances on the form.
- ADF&G numbers are listed for each of the delivering catcher vessels.
- Every day at the plant is recorded with the date and any delivery information or lack thereof.
- The entire Landing Report ID Number is listed for each delivery.
- E-landing Management Program number is recorded correctly for each offload.

INSEASON ADVISING

Inseason Advisors

Observers deployed on vessels and shoreside processors equipped with ATLAS are assigned Observer Program staff acting as inseason advisors. Inseason advisors are available to answer sampling and data recording questions. They will review your data submitted via ATLAS and request corrections. If you are uncertain about something send a message to your inseason advisor. Remember that your inseason advisor is not a substitute for the manual. Always refer to your manual before asking questions.

There are a few vessels, primarily participating in the rockfish and the pollock fisheries that are equipped with ATLAS but do not have transmission capabilities allowing for the sending and receiving of ATLAS messages. If you are deployed on one of these vessels you will not have an inseason advisor. Using your personal email to seek guidance from NMFS staff is acceptable, but any observer data should be deleted from your personal equipment at the completion of your assignment.

Vessels fishing in the partial coverage sector are not required to provide at sea transmission capabilities and you will transmit your data, send and receive messages once you return to port.

Inseason Messages

The tone of an inseason message can often be misinterpreted. Error reports and questions should not be viewed as negative as they are provided to help you collect the best possible data.

Observers Responsibilities:

- Send a message to your inseason advisor as soon as you board the vessel. If you are deployed in the partial coverage sector, send your inseason advisor a message as soon as you have a confirmed vessel assignment.
- Check for inseason messages daily or whenever you have internet access.
- When there are multiple observers on a vessel or at a plant, all observers are required to communicate with the inseason advisor. Questions from the inseason advisor must be answered within 2 business days of receiving the message.
- Once you have developed a sample design, send your

inseason advisor a detailed description of your sample plan for review.

- Contact your advisor if you have an injury or illness and explain how it is affecting your work. For additional information see “Illnesses and Accidents” on page 19-11.
- Contact your advisor if there is a marine casualty. For additional information on how to document this incidents; see “Marine Casualties” on page 19-12.
- Address error reports and ensure all corrections are made on your paper forms and in ATLAS. Re-submit your data once all corrections have been made.
- Proofread your messages before sending them.
- Follow all your inseason advisor’s instructions. They may ask you to complete additional tasks that include but are not limited to:
 - Completing the Post Trip Summary Questions
 - Mailing data
 - Scheduling a phone call to discuss data collection issues while in the field

Your inseason messages are part of your data and constitute a legal document. Do not use inappropriate language or discuss vessel personnel in a derogatory manner.

Post Trip Summary Questions:

If you are deployed in the partial coverage sector, your inseason or advisor will instruct you to complete the Post Trip Summary Questions found in your Observer Cruise Logbook for each vessel assignment. You will be sending the answers to each Post Trip Summary Questionnaire via an ATLAS message. Answers to the post trip summary questions should be a complete description of your duties. For example:

Non-Pollock Trawl Post Trip Summary Question 11: “Describe how you selected and collected fish for predominant and secondary species for sex/lengths?”

Answer 11: *“I obtained a random sample for sexed length from one species composition sample as I only collected one large sample on this vessel. The sample was in a checker bin, and filled the bin to about 15cm. I used a visual grid to split the checker bin into quadrants. I marked the midpoint of the bin with my knife using my tape measure to ensure*

it was the midpoint. I feel the visual demarcations are accurate. The predominant species is Pacific Cod and they are large. With Pacific Cod approximately 20-30 fish are normally in each quadrant. In the future, if we have a haul where the predominant species changes I will simply collect all the fish in the quadrant, and do basket dumps until I obtain about 20. A basket dump is done by setting two empty sample baskets side by side lengthwise. I number them as odd (left one) and even (right one). I dump the full basket into the middle of the two baskets, and then select a number from the RNT. If it's an odd number I select the left basket and if it's an even number I select the right basket. If there were still too many fish in the selected basket I would repeat the process until about 20 were collected..

Mailing Data:

Your inseason advisor may ask you to mail or drop off at a field office, specific components of your data. This is common for observers that are deployed to a vessel in the partial coverage sector. If you are requested to mail your data, you will be provided with an addressed, prepaid envelope to mail data. Once instructed to do so, complete the addressee label with your inseason advisor's name. Seal the requested data in the envelope and personally drop it in a USPS postal drop box or send it directly from a post office. Do not send specimens with your data. In addition, send a message to your inseason advisor indicating the data has been sent. The chain of custody with your data MUST include you, the post office post office, and observer program staff. No one else should help with this process. **Only send data when requested by your inseason advisor!**

Please return any envelopes that are not used (regardless of condition) with your data at the time of debriefing.

Inseason Advisor Responsibilities

Inseason advising is a core duty for many observer program staff members. For those staff members assigned this responsibility it is recognized as an integral component of successful data collections. While interacting with your inseason advisor you should expect that they:

- Respond to any safety concerns immediately.
- Ensure the sample design(s) described are valid according to program protocols.
- Send data error reports at least once a week.
- Respond to any questions within two business days of

receiving the message.

- Maintain an open communication channel with the observers in the field.

Inseason Questions and Messages

When you ask a question:

- Please first refer to your manual for the answer to your question. If you still cannot find the answer or the answer is not clear, send the question to your inseason advisor and include where you have looked for the information.
- If you do not hear from your inseason advisor within two business days of sending your initial message, contact Observer Program staff ("Contact Addresses and Numbers" on page A-61). This allows for confirmation that ATLAS messaging is working.
- If you have not received an answer to a question you sent or received an incomplete answer, please ask your advisor again to ensure the question is received or understood by your advisor.
- If you have any concerns with your inseason advisor (e.g. pattern of delayed responses and/or no weekly error reports), contact your provider and contact the observer program ("Contact Addresses and Numbers" on page A-61).

Responding to Questions From Your Advisor

It is important to respond promptly to all directions or questions given to you by your inseason advisor or other Observer Program staff. When you receive a message from your inseason advisor you should:

- Respond as soon as you can and ask for clarification if you do not understand any part of the message. Be specific regarding the parts of the message that are unclear to you.
- Address questions or corrections as soon as possible. A response is expected within 1 or 2 days of receiving the message.
- Make corrections in a timely manner while keeping in mind your sampling workload. Some data corrections must be done immediately. If the change needs to be done immediately you will be told so in the message.
- Not following directions or answering questions in a timely manner can negatively impact data quality.

Failure to respond promptly to directions may be considered “not meeting expectations” and will be reflected in your final evaluation.

- Poor communication with inseason advisors may result in poor inseason management of the fishery, a longer than average debriefing, and loss of data.

First Days Messages

Be sure to alert your inseason advisor when you first board the boat.

Once you have developed a solid plan to complete all of the data collections required for your assignment, send your inseason advisor a detailed message describing this sample plan. *Describing your sample design in an inseason message can be difficult. Take your time to include a detailed description of your methods, be as thorough as possible in order for your inseason advisor to have a clear picture of your sampling strategy so they can make recommendations when necessary.*

Examples of First Messages to Inseason Advisor

“Just boarded. This is (first/last name and cruise #). Testing ATLAS. I will send everything else later.”

“Hello! We are settling in pretty well here. We completed the Safety Checklist and the captain ran a hands-on man-overboard drill. We store our survival suits and PLBs in our stateroom. We have arranged that whoever is off duty will grab the suits and PLBs if the alarm goes off and meet the observer on duty in the wheelhouse. I’ll send you a sample design as soon as we get settled, though it looks like we’ll be doing systematic spatial.”

Once you have been on the vessel for a few days please send a complete description of your sample design:

“We are using a systematic spatial design. The haul is divided into 9-12 equal units based on the vessel estimate. Our population is everything in the codend. The RNT is used to select the first sample within the first 3 units. From here every 3rd unit is sampled (ex: the vessel estimate is 45 mt, gives us 9 units of 5 mt each, RNT=1, we sample 0-5 mt, 15-20 mt, 30-35 mt, and so on). Since we sample 5 mt, we divide the population into 5 mt units. Our sample unit is weight. We may need to modify this for small hauls, but we haven’t had any yet. To get our pollock subset from within our sample we divide the sample size into 1mt units and use the RNT to select one. We then divide the selected ton into twenty 50 kg units and select one with the RNT and collect a

basket of fish from the selected unit. We use the pollock subset to collect sex length fish (if there are too many fish in the basket, we basket dump the entire basket into 2 baskets side by side and use the RNT to select one of those 2 baskets to get approximately 20 fish). We clear the sorting belt, have fish run onto it and collect all bycatch. We check to see the belt is clear before letting fish flow for the factory again. We used the RNT to select a haul for otoliths (haul 3). The RNT will be used to select fish for S/L/W and otoliths (lining up the fish on the observer table and assigning them numbers) from the sex length fish. If we have hauls with 2 predominant species subsamples will be collected in a manner similar to our subset collection. Thanks! Wally and Polly.”

Inseason Error Report Messages

Your inseason advisor will routinely review your data to get a feel for how things are going for you. They will look at sample designs, sample sizes, and composition data and make suggestions or ask questions as needed. Many times you will receive a message that simply says:

“How are things going out there? Looked at your data and everything looks pretty good. Let me know if you need anything. Keep up the good work. Thanks, Ed”

Inseason advisors are expected to run an error report at least once per week. The following is an example of a typical error report message:

- “Hi Polly and Wally, H 836-s3 (haul 836 sample 3) and H838-s4 have brittle starfish without a weight. Remember everything must be weighed on trawlers. If these were too small to register a weight on the MCP, enter 0.01 kg. H822 is coded as random systematic, but only one sample was taken. This may be fine, but just checking. Missing lengths for H831 and 834. H838-s301 has a starfish in the subsample, but none in the parent sample. Are you sure you were able to collect all the starfish from your sample? It is not likely and if you cannot be positive you’ve collected all the bycatch from a sample, you need to be taking samples where everything is weighed on the MCP. It’s the same situation for H838-s301 and 401 eelpout, H838-s501 pollock, H838-s501 g.sculpin. H835-s1 northern rocksole lengths should likely be a census. Thanks, Joe”

MID-CRUISE DEBRIEFING

This mid-cruise debriefing, provides the opportunity for both the observer and Observer Program staff to

assess the quality of the data collected up to that time, the methods employed, and any difficulties that you have encountered in your assignments. Your mid-cruise debriefing should take place early in your deployment to allow you to incorporate suggestions and make improvements on your data collection efforts. It also provides an opportunity to discuss future vessel assignments and discuss any questions that have come up since your last training or briefing. Be sure to pick up a copy of a salmon genetics salmon query if you have collected genetics specimens. An in person mid-cruise debriefing is also an opportunity to pick up additional gear, replace lost or broken gear and to drop off any specimens that can be shipped to the observer program offices prior to the completion of your deployment. During your mid-cruise you can also request print outs of data already entered to get a head start on data checks.

Where Do I Go for my Mid-Cruise Debriefing?

An in person mid-cruise is preferred when possible. In person mid-cruises can be conducted at any observer program office. Most in person mid-cruises are conducted by staff in Dutch Harbor, and Kodiak. If you are in Kodiak, Dutch Harbor, Anchorage or Seattle during working hours it is preferred, but not necessary, to call in advance to schedule an appointment. You may stop by the field office and let a staff member know that you are there for a mid-cruise debriefing, but making an appointment is best. *If you are unable to perform an in-person mid-cruise, refer to “What Do I Do If I Can’t Get To an Observer Program Field Office?”* on page 21-8. The field offices are staffed Monday through Friday from at least 9:00 a.m. to 5:00 p.m. The Kodiak and Dutch Harbor offices are staffed with variable hours on Saturday and Sunday. In order to successfully complete the mid-cruise, you must bring:

- Your logbook
- All data collected to date. If you are the second observer bring several Deck Forms you completed (you may bring copies if needed).
- Your completed species ID forms.
- Your scales for a mid-point check, *even if you have not used them yet.*
- A list of questions that have come up during any of your assignments. This is the best opportunity during the season for you to discuss these issues and obtain

answers!



Observer Program offices are often staffed outside of regular business hours. If you can't make it in during the times listed, call ahead. Staff will usually be able to accommodate your schedule. See “Contact Addresses and Numbers” on page A-61.

What Do I Do if the Office Is Closed?

If your vessel is in town during off hours or on weekends, or you are passing through Anchorage or Seattle, you should contact the office for a mid-cruise. Leave a message stating your name, vessel, estimated duration in town, how you can be contacted and the estimated time and date that you will be available for a mid-cruise. Also, work with your employer as they may be able to arrange an appointment for your mid-cruise.

Am I Required To Have a Mid-cruise Debriefing?

All observers on their first and second contract are required to have a mid-cruise debriefing. All other observers, *unless specifically exempted from a mid-cruise during their previous evaluation*, must complete an in-person, mid-deployment data review if they travel through a location where Observer Program staff are available. This debriefing is not an option and must be completed in order to fulfill your responsibilities as an observer. If you are unsure if a mid-cruise debriefing is necessary, ask your employer or stop in to the field station.

When Do I Have a Mid-cruise Debriefing?

Observers should report for their mid-cruise debriefing early on in their assignment. Observers on catcher only vessels (trawl, longline and pot) should schedule this debriefing after the first couple of deliveries while those on catcher processors should report during their first or second offload.

What Do I Do If I Can't Get To an Observer Program Field Office?

On rare occasions, observers are unable to arrange a meeting time. In this case, and only as a last resort, answer the following questions and fax them to one of the field offices or the main office in Seattle or send via ATLAS message to your advisor and send the required forms once you have access to e-mail or a fax machine (see “Contact Addresses and Numbers” on page A-61).

You should go to a field office for a follow-up mid-cruise if possible.

1. Describe in detail how the observer estimate was made and how often you are making observer estimates. Describe the collection technique you used to get fish for density. What was the average density value and predominant species in the catch? Were there any problems with the certified flow scale? If no observer estimates were made, explain why.
2. Give a detailed description of your sampling design. Describe your sampling area, how you collected samples, and if there were any difficulties. What methods did you employ to ensure the least amount of sample bias using random sampling techniques?
3. Did you obtain sexed length frequencies and specimens? Please describe methods used and any difficulties you encountered sexing fish. Also describe how halibut viabilities/injury assessments and lengths were collected. If none were collected, please explain why.
4. If you are using hanging scales, describe which scale you are using to record weights. If the issued double pulleys are being used with the 50 kg scale, describe how you have set this up.
5. If on a longliner or pot boat describe your method for verifying the amount of gear the vessel reported setting. This is your method for independently verifying the vessel reported segments in a haul (e.g., counting gear). Reference the longline and pot sections for some examples of gear verification. Also describe where you document this information and if any calculations are done.
6. If on a longliner describe your methods for hook counts. Include how often and the percent of a typical size haul you are counting. Where are you documenting your hook counts?

Describe anything that has affected your ability to effectively conduct your work. Have you been able to complete any research projects or other assignments?

In addition to answering the questions, you must also fax in the items listed below. Failure to include these items will be grounds for an incomplete faxed mid-cruise.

1. 3 to 4 Species ID Forms.

2. 2 to 3 Deck Forms.
3. 1 to 2 VHF and OHF Paper Forms.
4. 1 Plant/Vessel Offload Form (plant and catcher vessel observers).
5. 2 to 3 pages of daily notes.
6. 3 to 4 hook counts (if assigned to a longline vessel).
7. Sample station diagrams from your observer logbook.
8. Both sides of the safety checklist.
9. Scale tests.
10. Any questions or safety concerns.

FINAL DEBRIEFING

The final debriefing occurs after the completion of your last vessel assignment. Most likely, this will take place in the Seattle or Anchorage Observer Program office, though field debriefings are sometimes possible. In-person debriefing will be the standard though some remote debriefing will be allowed depending on the observer's experience and the amount of data they have. Remote debriefing will be the exception, not the norm. The majority of debriefing tasks consist of the following:

- Completion of electronic vessel survey for each vessel
- Data checks, error corrections, and resubmission of corrected data
- Preparation of all specimens collected during your cruise
- Debriefing interview
- Gear check-in or replenishment
- Completion of the post-debriefing questionnaire

The time to complete this process is variable but observers should expect to spend approximately two to five days to complete the debriefing process once it has started. During busy times, you should expect to wait for a few days before a staff member is available to schedule the debriefing interview.

Completing the debriefing process is a critical part of your duties as an observer! Do NOT make plane reservations or other commitments until you are sure that your data

have been finalized. Failure to complete the debriefing process as scheduled is grounds for decertification.

At the end of the debriefing, you will receive an evaluation of your work and performance. This evaluation will include a list of specific points covering a variety of aspects pertinent to your overall deployment, as well as comments addressing overall effort in completing duties, level of documentation of activities, and any issues of note encountered during your debriefing. The evaluation will also include a recommendation for your next briefing requirement.

Scheduling and Check-in Tasks

Once you have disembarked from your last assignment, your employer will contact the Observer Program Office and schedule an appointment for your pre-debriefing duties and data/specimen check-in.

Your contractor and/or an automatically generated email will notify you of when you are scheduled for your check in appointment. Please report to the observer computer room (Room 1085) at your scheduled time. Unexcused lateness will be reported to your contractor. If you are running late or for any reason you need to speak to check-in staff, use the Check in hotline in the contacts "Appendix X: Contact Addresses and Numbers" on page A-61. You are expected to bring the following items to your initial check in appointment,

- PLB
- Logbook
- Data and Species ID forms
- Thumb Drive
- Otoliths
- Hanging Scales
- Camera Equipment
- Salmon Scales and Genetics
- Extra Forms

Please do not bring your entire gear set. A gear appointment will be made for a future date.

A list of tasks to be completed is available in the Observer Check-in (OCI) Kiosk. Clicking on the Observer Portal Icon will walk you through the check-in process. You

will be turning in your camera and PLB, scheduling a separate gear check-in appointment, processing your specimens (otoliths, photos, etc.), edit checking data printouts, and testing your hanging scales.

During your check-in appointment, you will be notified if you will be debriefing in-person or remotely. FMA check-in staff might have this information but ultimately this information will be relayed to you by your provider.

Observer Program staff will do their part to make sure your debriefing is as thorough as necessary and completed in a reasonable amount of time. Each observer can help expedite this process by being prepared for debriefing and keeping their employer and the Observer Program informed of any difficulties in attending and completing the debriefing process. Remember, ensuring the data are of high quality is the main purpose of the debriefing process.

Submitting Data

Be sure that all your data submissions are complete and have been transmitted. Failure to do this could delay your debriefing.

All of your data forms should be filled out at sea and completed prior to your debriefing interview. Keeping up with your work becomes especially important if you are deployed on more than one vessel or plant. Keep in mind that some corrections will affect data on other forms and those must be corrected as well. Cross reference the data on all forms to be sure that the correct data is recorded on each form type. *Also, if you were on more than one ship and/or plant, the data from each need to be kept separate.* Do not mix the data forms together; number the pages separately for each vessel/plant and form type.

Reviewing Data for Errors Prior to Debriefing

Observers who regularly check their data at sea generally benefit by having shorter, smoother debriefings. Observers who do not check their data throughout their cruise generally find themselves in lengthy debriefings with time consuming corrections, causing delays in debriefing for others.

Vessel Survey

The vessel survey is completed before the debriefing interview, often while still in the field. This survey is done for each vessel and/or plant of your deployment and serves as the most detailed and accurate description of your cruise. The survey is in multiple choice format

with some of the questions requesting further comment. ***Detailed answers to these questions are important.*** These data are used by many different groups including future observers, fishery managers, your debriefer, and other NMFS staff. Any comments that are unclear or incomplete will be reviewed and corrected during the interview. Responses in the survey will explain and support the respective data collected as well as provide a detailed and accurate description of each assignment. Once again, thoroughness in this step will expedite debriefing!

Debriefing Interview

The interview will be scheduled after you complete your pre-debriefing tasks, submit your data, and as debriefing staff become available. During the interview, your debriefer will ask you to clarify or elaborate on any issues not fully addressed in the vessel survey. In addition, each data type will be checked for completeness, accuracy, and format.

During the interview, both you and the debriefer discuss your time at sea, your sampling methods, and the resulting data. The most important aspects of the interview are honesty and willingness to discuss problems and difficulties. Tell your debriefer about the challenges you encountered and the solutions you implemented. This facilitates discussion of sampling methodology and ways data collections might be improved. Your feedback makes staff aware of vessel specific sampling difficulties and can help the next observer deployed on that vessel. The interview is designed to be a productive process beneficial for both the observer and the debriefer. Professional conduct through cooperation, candor, and effort is expected of all participants.

An error report of your data is produced and checks of the data are performed by the debriefer. The main purpose of the error check is to compare data between form types, search for missing data, and flag questionable entries. This report will be reviewed during the interview and all corrections will be made at that time. In addition, all forms will be checked and compared with the electronic data.

Gear Check-in

Returning your NMFS sampling gear is an important part of successfully completing your deployment. The expectation is that gear will be returned or replenished during the debriefing process. During the initial check-

in, an appointment to return your gear will be made in the Observer Check-In System (OCI). Before the gear is checked-in, it must be as clean as when it was issued to you and completely dry. Failing to follow these guidelines may result in having to reschedule your appointment and delaying the completion of your deployment. Best practice is to allow for a day of cleaning at least one day before the scheduled appointment. The gear room in Seattle can be a busy place. If you miss your appointment or do not have clean and dry gear it may be several days before you are able to reschedule.

Evaluations

An observer's work and performance are evaluated after each cruise. This evaluation serves two purposes. First, it provides a summary of the work performed, your effort, and the quality of the data. Second, it serves as a training tool for future deployments by identifying areas of needed improvement and giving recommendations and suggestions. ***The areas of greatest importance are compliance throughout the deployment with established protocols and an understanding of sampling concepts.***

The evaluation is based on many factors including but not limited to:

- Sampling methods used
- Documentation and professional communication
- Preparedness for all debriefing tasks
- Problem solving skills
- Overall effort
- Care and cleanliness of sampling gear

Based on this evaluation, you are given a score for each of your assignments. Observers who receive a score of 1 have met the expectations of the Observer Program. This means that proper sampling methods were applied and protocols for data collection were followed. Observers who receive a score of 1 will receive a written evaluation which describes the work that was done and may include some suggestions to apply during a subsequent cruise.

A score of 0 on any vessel/plant signifies the expectations of the Observer Program have not been met. Based on the severity of the problems, there are several different courses of action. You will receive a written evaluation detailing the area(s) of your work or performance that were unacceptable. The purpose of this evaluation is

to provide you with a tool to improve performance on future cruises.

Observers who are unable to meet our sampling and data recording requirements may be recommended for decertification. The decision to recommend decertification is made by debriefers and other program staff and it is not taken lightly. Most cases of decertification involve conduct and behavior that affects performance or safety, falsification of data, or errors resulting in significant amount of unreliable data, or a significant loss of data.

If you are recommended for decertification, the observer program will follow NMFS' regulations governing the decertification process. The decertification process provides you the opportunity to present your arguments and perspective on any action we propose to take, and to appeal decisions. It is designed to provide you a fair hearing on any issues that could result in your certification being revoked. All Observer Program regulations and procedures can be found in Subpart E of the CFR at <https://www.ecfr.gov/current/title-50/chapter-VI/part-679#subpart-E>.

You are not done with the debriefing process until all components of this process are completed and your debriefer has informed you that you are finished.

TABLE OF CONTENTS FOR APPENDICES

| | |
|---|------|
| Species Codes for Fishes and Invertebrates | A-3 |
| Species Code List - Seabirds | A-13 |
| Species Code List - Marine Mammals | A-17 |
| Abbreviations, Conversions, and Formulas | A-19 |
| Random Number Table. | A-21 |
| Product Recovery Rates (PRR) | A-22 |
| Product Codes and Description | A-24 |
| NMFS Species and Group Codes Used in Vessel Logbooks | A-25 |
| Alaska Department of Fish and Game Fish Ticket Codes | A-26 |
| Port Codes and Non-Fishing Day Port Positions | A-27 |
| Processor Permit List | A-29 |
| Vessel Names and Permit Numbers. | A-31 |
| NMFS Reporting Areas for the Bering Sea and Aleutian Islands | A-43 |
| NMFS Reporting Areas for the Gulf of Alaska | A-44 |
| Decimal Minutes to Seconds Conversion Chart. | A-45 |
| Shark Length to Weight Tables | A-47 |
| Skate Length to Weight Table | A-49 |
| Halibut Condition Criteria For Trawl Bycatch | A-51 |
| Key to Pacific Halibut Viability for Trawl Vessels | A-52 |
| Halibut Injury Criteria For Longline Bycatch | A-53 |
| Key to Longline Injury Codes for Pacific Halibut | A-55 |
| Halibut Condition Criteria For Pot Bycatch | A-57 |
| Key to Pot Condition Codes for Pacific Halibut | A-59 |
| Contact Addresses and Numbers | A-61 |
| Workplace Violence Prevention & Response Information | A-63 |
| Radio Instructions | A-64 |
| Beam Balance Flatbed Scale Care and Maintenance | A-66 |
| NMFS-Permitted Contractors for the Fisheries Monitoring and Analysis Division | A-67 |
| Using the Interval and Time Approximation Tables. | A-68 |
| Freon Information | A-77 |
| Anhydrous Ammonia Information | A-78 |

This page intentionally left blank

APPENDIX A: SPECIES CODES FOR FISHES AND INVERTEBRATES

| Code | Common Name | Scientific Name |
|-------------|---|--|
| 106 | Alaska Plaice | <i>Pleuronectes quadrituberculatus</i> |
| 610 | Anchovy, Northern | <i>Engraulis mordax</i> |
| 55 | Anemone, Sea - unidentified | <i>Actiniaria</i> |
| 43 | Ascidians, Sea Squirt, Tunicate | <i>Ascidacea</i> |
| 204 | Atka Mackerel | <i>Pleurogrammus monoptygius</i> |
| 48 | Barnacles | <i>Cirripedia</i> |
| 770 | Barracudina - unidentified | <i>Paralepididae</i> |
| 289 | Bigscale - unidentified | <i>Melamphaidae</i> |
| 54 | Bristleworm (Polychaete unidentified) | <i>Polychaeta</i> |
| 32 | Bryozoans | <i>Bryozoa</i> |
| 604 | Capelin | <i>Mallotus villosus</i> |
| 44 | Chiton - unidentified | <i>Polyplacophora</i> |
| 29 | Clams, Mussels, Oysters, Scallops | <i>Bivalvia</i> |
| 215 | Cod - unidentified | Gadidae sp. |
| 211 | Cod, Arctic * | <i>Boreogadus saida</i> |
| 203 | Cod, Black (Sablefish) | <i>Anoplopoma fimbria</i> |
| 202 | Cod, Pacific | <i>Gadus macrocephalus</i> |
| 209 | Cod, Pacific Tomcod | <i>Microgadus proximus</i> |
| 208 | Cod, Saffron | <i>Eleginus gracilis</i> |
| 214 | Codling - unidentified (See also Flatnose, Pacific) | <i>Moridae</i> |
| 32 | Coral - unidentified | <i>Anthozoa</i> |
| 815 | Coral, Hydrocorals | <i>Anthoathecatae</i> |
| 816 | Coral, Stony Corals | <i>Scleractinia</i> |
| 817 | Coral, Gorgonians | <i>Gorgonacea</i> |
| 818 | Coral, Black Corals | <i>Antipatharia</i> |
| 819 | Coral, Soft Corals | <i>Alcyonacea</i> |
| 58 | Coral, Sea Pens and Sea Whips | <i>Pennatulacea</i> |
| 1 | Crab - unidentified (Family Unknown) | Decapoda |

* If you encounter these species, please bring a specimen back to NMFS.

Contact NMFS *if you use any species/species group* shown in **Bold Print.**

| Code | Common Name | Scientific Name |
|-------------|--|------------------------------------|
| 11 | Crab, Box | <i>Lopholithodes foraminatus</i> |
| 39 | Crab, Decorator | <i>Oregonia gracilis</i> |
| 12 | Crab, Dungeness | <i>Cancer magister</i> |
| 841 | Crab, Fuzzy | <i>Acantholithodes hispidus</i> |
| 7 | Crab, Hair(Horsehair) | <i>Erimacrus isenbeckii</i> |
| 15 | Crab, Hermit -unidentified | <i>Paguridae</i> |
| 2 | Crab, King -unidentified | <i>Lithodes & Paralithodes</i> |
| 6 | Crab, King, Blue | <i>Paralithodes platypus</i> |
| 8 | Crab, King, Brown(Golden) | <i>Lithodes aequispinus</i> |
| 16 | Crab, King, Couesi | <i>Lithodes couesi</i> |
| 13 | Crab, King, Red | <i>Paralithodes camtschaticus</i> |
| 14 | Crab, Lithodid unidentified (Brown, Couesi or Golden) | <i>Lithodidae sp.</i> |
| 840 | Crab, Lyre -unidentified | <i>Hyas sp.</i> |
| 17 | Crab, Paralomis multispina | <i>Paralomis multispina</i> |
| 38 | Crab, Paralomis verrilli | <i>Paralomis verrilli</i> |
| 842 | Crab, Rhinoceros | <i>Rhinolithodes wosnessenskii</i> |
| 31 | Crab, Scaled | <i>Placetrion wosnessenskii</i> |
| 3 | Crab, Tanner -Unidentified | <i>Chionoecetes sp.</i> |
| 19 | Crab, Tanner, Angulatus | <i>Chionoecetes angulatus</i> |
| 4 | Crab, Tanner, Bairdi | <i>Chionoecetes bairdi</i> |
| 5 | Crab, Tanner, Opilio | <i>Chionoecetes opilio</i> |
| 18 | Crab, Tanner, Tanneri | <i>Chionoecetes tanneri</i> |
| 23 | Crab, Telmessus | <i>Telmessus cheiragonus</i> |
| 53 | Crinoids -unidentified | <i>Crinoidea</i> |
| 144 | Dab, Longhead | <i>Limanda proboscidea</i> |
| 679 | Daggertoosts | <i>Anotopteridae</i> |
| 899 | DecomposedFish | |
| 799 | Dragonfish -unidentified | <i>Melanostomiinae</i> |
| 690 | Dreamer -unidentified | <i>Oneirodidae</i> |
| 250 | Eelpout -unidentified | <i>Zoarcidae</i> |

* If you encounter these species, please bring a specimen back to NMFS.

Contact NMFS *if you use any species/species group* shown in **Bold Print.**

| Code | Common Name | Scientific Name |
|-------------|---|-------------------------------------|
| 91 | Egg Case, Skate | |
| 34 | Eggs, Snail | Gastropoda |
| 601 | Eulachon (Candlefish) | <i>Thaleichthys pacificus</i> |
| 901 | Fish - unidentified | Osteichthyes |
| 100 | Flatfish - unidentified | Pleuronectiformes |
| 210 | Flatnose, Pacific (Codling) | <i>Antimora microlepis</i> |
| 141 | Flounder, Arrowtooth | <i>Atheresthes stomias</i> |
| 145 | Flounder, Bering | <i>Hippoglossoides robustus</i> |
| 149 | Flounder, Kamchatka/Arrowtooth - unidentified | <i>Atheresthes sp.</i> |
| 147 | Flounder, Kamchatka | <i>Atheresthes evermanni</i> |
| 142 | Flounder, Starry | <i>Platichthys stellatus</i> |
| 215 | Gadid - unidentified | Gadidae sp. |
| 102 | Greenland turbot | <i>Reinhardtius hippoglossoides</i> |
| 390 | Greenling - unidentified | <i>Hexagrammos sp.</i> |
| 80 | Grenadier, (Rattail) - unidentified | Macrouridae |
| 82 | Grenadier (Rattail), Giant | <i>Albatrossia pectoralis</i> |
| 430 | Gunnel - unidentified | Pholidae |
| 77 | Hagfish - unidentified | Myxinidae |
| 206 | Hake, Pacific | <i>Merluccius productus</i> |
| 101 | Halibut, Pacific | <i>Hippoglossus stenolepis</i> |
| 767 | Hatchetfish- unidentified | Sternoptychidae |
| 611 | Herring, Pacific | <i>Clupea pallasii</i> |
| 350 | Idiotfish (Shortspine Thornyhead) | <i>Sebastolobus alascanus</i> |
| 902 | Invertebrate - unidentified | Invertebrata |
| 33 | Isopod - unidentified | Isopoda |
| 35 | Jellyfish - unidentified | Scyphozoa |
| 900 | Kelp - miscellaneous | |
| 75 | Lamprey - unidentified | Petromyzontidae |
| 785 | Lancetfishes | Alepisauridae |
| 700 | Lanternfish - unidentified | Myctophidae |
| 52 | Leech - unidentified | Hirudinea |

If you encounter these species, please bring a specimen back to NMFS.

Contact NMFS *if you use any species/species group* shown in **Bold Print.**

| Code | Common Name | Scientific Name |
|-------------|---|-------------------------------------|
| 696 | Lightfish(Bristlemouth) | Gonostomatidae |
| 45 | Limpet -unidentified | |
| 603 | Lingcod | <i>Ophiodon elongatus</i> |
| 144 | Longhead dab | <i>Limanda proboscidea</i> |
| 525 | Lumpsucker -unidentified | Cyclopteridae |
| 204 | Mackerel, Atka | <i>Pleurogrammus monoptyerygius</i> |
| 786 | Mackerels and Tunas | Scombridae |
| 774 | Manefishes | Caristiidae |
| 900 | Miscellaneous - unidentified (rocks, mud, garbage, etc) | |
| 810 | Molas | Molidae |
| 29 | Mussels, Clams, Oysters, Scallops | Bivalvia |
| 25 | Nudibranch (SeaSlug) | Nudibranchia |
| 60 | Octopus-unidentified | Octopodiformes |
| 61 | Octopus, Pelagic | Octopodiformes |
| 297 | Opah | <i>Lampris guttatus</i> |
| 295 | Oreos | Oreosomatidae |
| 29 | Oysters, Clams, Mussels, Scallops | Bivalvia |
| 301 | Pacific Ocean Perch | <i>Sebastes alutus</i> |
| 762 | Paperbones, Scaly -unidentified | Notosudidae |
| 830 | Peanutworms | Sipuncula |
| 450 | Poacher -unidentified | Agonidae |
| 201 | Pollock (Walleye Pollock) | <i>Gadus chalcogrammus</i> |
| 54 | Polychaete - unidentified(Bristleworm) | Polychaeta |
| 765 | Pomfret -unidentified | Bramidae |
| 750 | Prickleback -unidentified | Stichaeidae |
| 205 | Prowfish | Zaproridae |
| 280 | Ragfish | Icosteidae |
| 99 | Ratfish, Spotted | <i>Hydrolagus colliei</i> |
| 80 | Rattail, (Grenadier) -unidentified | Macrouridae |
| 82 | Rattail (Grenadier), Giant | <i>Albatrossia pectoralis</i> |

* If you encounter these species, please bring a specimen back to NMFS.

Contact NMFS *if you use any species/species group* shown in **Bold Print.**

| Code | Common Name | Scientific Name |
|-------------|--|--|
| 90 | Ray, (Skate) -unidentified | Rajiformes |
| 300 | Rockfish -unidentified | Scorpaenidae |
| 353 | Rockfish, Aleutian Scorpionfish* | <i>Adelosebastes latens</i> |
| 306 | Rockfish, Black | <i>Sebastes melanops</i> |
| 316 | Rockfish, Blue* | <i>Sebastes mystinus</i> |
| 302 | Rockfish, Bocaccio | <i>Sebastes paucispinis</i> |
| 351 | Rockfish, Broadbanded Thornyhead* | <i>Sebastolobus macrochir</i> |
| 332 | Rockfish, Brown | <i>Sebastes auriculatus</i> |
| 314 | Rockfish, Canary | <i>Sebastes pinniger</i> |
| 346 | Rockfish, China | <i>Sebastes nebulosus</i> |
| 327 | Rockfish, Copper* | <i>Sebastes caurinus</i> |
| 345 | Rockfish, Dark (was Dark Dusky) | <i>Sebastes ciliatus (was S. sp. cf. ciliatus)</i> |
| 311 | Rockfish, Darkblotched | <i>Sebastes crameri</i> |
| 330 | Rockfish, Dusky (was Light Dusky) | <i>Sebastes variabilis (was S. ciliatus)</i> |
| 317 | Rockfish, Gray* | <i>Sebastes glaucus</i> |
| 313 | Rockfish, Greenstriped | <i>Sebastes elongatus</i> |
| 323 | Rockfish, Harlequin | <i>Sebastes variegatus</i> |
| 352 | Rockfish, LongspineThornyhead | <i>Sebastolobus altivelis</i> |
| 303 | Rockfish, Northern | <i>Sebastes polyispinis</i> |
| 301 | Rockfish, Pacific Ocean Perch (POP) | <i>Sebastes alutus</i> |
| 335 | Rockfish, Pygmy* | <i>Sebastes wilsoni</i> |
| 343 | Rockfish, Quillback | <i>Sebastes maliger</i> |
| 308 | Rockfish, Redbanded | <i>Sebastes babcocki</i> |
| 324 | Rockfish, Redstripe | <i>Sebastes proriger</i> |
| 309 | Rockfish, Rosethorn | <i>Sebastes helvomaculatus</i> |
| 307 | Rockfish, Rougheyeye | <i>Sebastes aleutianus</i> |
| 304 | Rockfish, Sharpchin | <i>Sebastes zacentrus</i> |
| 326 | Rockfish, Shortraker | <i>Sebastes borealis</i> |
| 354 | Rockfish, Shortraker/Rougheyeye unidentified | <i>S. borealis oraleutianus</i> |
| 350 | Rockfish, ShortspineThornyhead | <i>Sebastolobus alascanus</i> |
| 310 | Rockfish, Silvergray | <i>Sebastes brevispinis</i> |

* If you encounter these species, please bring a specimen back to NMFS.

Contact NMFS *if you use any species/species group* shown in **Bold Print.**

| Code | Common Name | Scientific Name |
|-------------|---|---------------------------------|
| 315 | Rockfish, Splitnose | <i>Sebastes diploproa</i> |
| 328 | Rockfish, Stripetail * | <i>Sebastes saxicola</i> |
| 349 | Rockfish, Thornyhead unidentified | <i>Sebastolobus</i> sp. |
| 329 | Rockfish, Tiger | <i>Sebastes nigrocinctus</i> |
| 331 | Rockfish, Vermilion * | <i>Sebastes miniatus</i> |
| 305 | Rockfish, Widow | <i>Sebastes entomelas</i> |
| 322 | Rockfish, Yelloweye | <i>Sebastes ruberrimus</i> |
| 320 | Rockfish, Yellowmouth * | <i>Sebastes reedi</i> |
| 321 | Rockfish, Yellowtail | <i>Sebastes flavidus</i> |
| 240 | Ronquil - unidentified | Bathymasteridae |
| 200 | Roundfish - unidentified | |
| 203 | Sablefish (Black Cod) | <i>Anoplopoma fimbria</i> |
| 220 | Salmon - unidentified | <i>Oncorhynchus</i> sp. |
| 229 | Salmon, Atlantic* | <i>Salmo salar</i> |
| 221 | Salmon, Chum (Dog) | <i>Oncorhynchus keta</i> |
| 222 | Salmon, Chinook (King) | <i>Oncorhynchus tshawytscha</i> |
| 223 | Salmon, Coho (Silver) | <i>Oncorhynchus kisutch</i> |
| 225 | Salmon, Pink (Humpback) | <i>Oncorhynchus gorbuscha</i> |
| 224 | Salmon, Sockeye (Red) | <i>Oncorhynchus nerka</i> |
| 226 | Salmon, Steelhead (Ocean-run Rainbow Trout) | <i>Oncorhynchus mykiss</i> |
| 40 | Sand Dollars, Sea Urchins | Echinoidea |
| 239 | Sandfishes | Trichodontidae |
| 670 | Sand Lances | Ammodytidae |
| 136 | Sanddab - unidentified | Bothidae |
| 137 | Sanddab, Pacific | <i>Citharichthys sordidus</i> |
| 614 | Sardine, Pacific | <i>Sardinops sagax</i> |
| 29 | Scallops, Clams, Mussels, Oysters | Bivalvia |
| 353 | Scorpionfish, Aleutian * | <i>Adelosebastes latens</i> |
| 400 | Sculpin - unidentified | Cottidae |
| 402 | Sculpin, Bigmouth | <i>Hemitripterus bolini</i> |
| 415 | Sculpin, Butterfly | <i>Hemilepidotus papilio</i> |

* If you encounter these species, please bring a specimen back to NMFS.

Contact NMFS *if you use any species/species group* shown in **Bold Print.**

| Code | Common Name | Scientific Name |
|-------------|--|--|
| 395 | Sculpin, Darkfin | <i>Malacocottus zonurus</i> |
| 405 | Sculpin, Great | <i>Myoxocephalus polyacanthocephalus</i> |
| 418 | Sculpin, Irish Lord - unidentified | <i>Hemilepidotus sp.</i> |
| 434 | Sculpin, Longfin Irish Lord | <i>Hemilepidotus zapus</i> |
| 440 | Sculpin - <i>Myoxocephalus</i> unidentified | <i>Myoxocephalus spp.</i> |
| 399 | Sculpin, Plain | <i>Myoxocephalus jaok</i> |
| 407 | Sculpin, Red Irish Lord | <i>Hemilepidotus hemilepidotus</i> |
| 398 | Sculpin, Warty | <i>Myoxocephalus scorpius</i> |
| 414 | Sculpin, Yellow Irish Lord | <i>Hemilepidotus jordani</i> |
| 55 | Sea Anemone - unidentified | Actiniaria |
| 41 | Sea Cucumber - unidentified | Holothuroidea |
| 689 | Sea Devil - unidentified | Ceratiidae |
| 43 | Sea Onions, Sea Potato, Sea Squirts, Tunicates | Asciacea |
| 58 | Sea Pen, Sea Whip - unidentified | Pennatulacea |
| 43 | Sea Potato, Onions, Sea Squirts, Tunicates | Asciacea |
| 25 | Sea Slug - unidentified | Nudibranchia |
| 56 | Sea Spider - unidentified | Pycnogonida |
| 43 | Sea Squirts, Onions, Potatoes, Tunicates | Asciacea |
| 40 | Sea Urchins, Sand Dollars | Echinoidea |
| 58 | Sea Whip, Sea Pen - unidentified | Pennatulacea |
| 54 | Sea Worms (Polychaetes) - unidentified | Polychaeta |
| 900 | Seaweed - miscellaneous | |
| 606 | Shad, American | <i>Alosa sapidissima</i> |
| 65 | Shark - unidentified | Selachii |
| 69 | Shark, Blue | <i>Prionace glauca</i> |
| 62 | Shark, Pacific Sleeper (Mud) | <i>Somniosus pacificus</i> |
| 67 | Shark, Salmon | <i>Lamna ditropis</i> |
| 66 | Shark, Spiny Dogfish | <i>Squalus suckleyi</i> |
| 70 | Shrimp - unidentified | Caridea |
| 90 | Skate - unidentified | Rajiformes |

* If you encounter these species, please bring a specimen back to NMFS.

Contact NMFS *if you use any species/species group* shown in **Bold Print.**

| Code | Common Name | Scientific Name |
|-------------|---|---------------------------------|
| 88 | Skate, Alaska | <i>Bathyraja parmifera</i> |
| 85 | Skate, Aleutian | <i>Bathyraja aleutica</i> |
| 97 | Skate, Bering | <i>Bathyraja interrupta</i> |
| 94 | Skate, Big | <i>Beringraja binocolata</i> |
| 163 | Skate, Commander | <i>Bathyraja lindbergi</i> |
| 92 | Skate, Deepsea * | <i>Bathyraja abyssicola</i> |
| 95 | Skate, Longnose | <i>Raja rhina</i> |
| 165 | Skate, Mud | <i>Bathyraja taranetzi</i> |
| 166 | Skate, Roughshoulder * | <i>Amblyraja badia</i> |
| 89 | Skate, Roughtail | <i>Bathyraja trachura</i> |
| 159 | Skate - <i>Bathyraja</i> /Soft Snout unidentified | <i>Bathyraja sp.</i> |
| 167 | Skate - <i>Raja</i> /Stiff Snout unidentified | <i>Raja sp.</i> |
| 164 | Skate, Whiteblotched | <i>Bathyraja maculata</i> |
| 162 | Skate, Whitebrow | <i>Bathyraja minispinosa</i> |
| 212 | Skilfish | <i>Erilepis zonifer</i> |
| 602 | Smelt - unidentified | Osmeridae |
| 604 | Smelt, Capelin | <i>Mallotus villosus</i> |
| 628 | Smelt, Deepsea unidentified | Bathylagidae |
| 601 | Smelt, Eulachon (Candlefish) | <i>Thaleichthys pacificus</i> |
| 605 | Smelt, Rainbow | <i>Osmerus mordax</i> |
| 613 | Smelt, Surf | <i>Hypomesus pretiosus</i> |
| 30 | Snail - unidentified | Gastropoda |
| 34 | Snail Eggs | |
| 36 | Snail, Empty Shell | |
| 500 | Snailfish - unidentified | Liparidae |
| 559 | Snipe Eel - unidentified | Nemichthyidae |
| 109 | Sole, Butter | <i>Isopsetta isolepis</i> |
| 118 | Sole, C-O * | <i>Pleuronichthys coenosus</i> |
| 117 | Sole, Curlfin * | <i>Pleuronichthys decurrens</i> |
| 110 | Sole, Deepsea | <i>Embassichthys bathybius</i> |
| 107 | Sole, Dover | <i>Microstomus pacificus</i> |

* If you encounter these species, please bring a specimen back to NMFS.

Contact NMFS *if you use any species/species group* shown in **Bold Print.**

| Code | Common Name | Scientific Name |
|-------------|---|-------------------------------------|
| 108 | Sole, English | <i>Parophrys vetulus</i> |
| 103 | Sole, Flathead | <i>Hippoglossoides elassodon</i> |
| 108 | Sole, Lemon | <i>Parophrys vetulus</i> |
| 112 | Sole, Petrale | <i>Eopsetta jordani</i> |
| 105 | Sole, Rex | <i>Glyptocephalus zachirus</i> |
| 104 | Sole, Rock, unidentified | <i>Lepidopsetta</i> sp. |
| 120 | Sole, Rock, Northern | <i>Lepidopsetta polyxystra</i> |
| 121 | Sole, Rock, Southern *(<i>Bering Sea North of 56° only</i>) | <i>Lepidopsetta bilineata</i> |
| 114 | Sole, Roughscale * | <i>Clidoderma asperrimum</i> |
| 148 | Sole, Sakhalin * | <i>Limanda sakhalinensis</i> |
| 115 | Sole, Sand *(<i>No collection required in the GOA</i>) | <i>Psettichthys melanostictus</i> |
| 111 | Sole, Slender | <i>Lyopsetta exilis</i> |
| 140 | Sole, Yellowfin | <i>Limanda aspera</i> |
| 26 | Sponge - unidentified | Porifera |
| 270 | Squairetail, Smalleye | <i>Tetragonurus cuvieri</i> |
| 50 | Squid - unidentified | Teuthida |
| 511 | Squid, Humboldt | <i>Dosidicus gigas</i> |
| 51 | Squid, Robust Clubhook | <i>Moroteuthis robusta</i> |
| 20 | Starfish - unidentified | Asteroidea |
| 21 | Starfish, Basket | <i>Gorgonocephalus</i> sp. |
| 22 | Starfish, Brittle | Ophiuroidea |
| 226 | Steelhead | <i>Oncorhynchus mykiss</i> |
| 230 | Sturgeon - unidentified * | <i>Acipenser</i> sp. |
| 810 | Sunfish, Ocean | <i>Mola mola</i> |
| 807 | Tubeshoulder - unidentified | Platyroctidae |
| 786 | Tunas and Mackerels | Scombridae |
| 43 | Tunicates, Ascidians, Sea Squirts | Ascidiacea |
| 102 | Turbot, Greenland | <i>Reinhardtius hippoglossoides</i> |
| 805 | Viperfish - unidentified | Chauliodontinae |
| 899 | Waste -- Decomposed Fish | |

* If you encounter these species, please bring a specimen back to NMFS.

Contact NMFS *if you use any species/species group* shown in **Bold Print.**

| Code | Common Name | Scientific Name |
|-------------|---|--|
| 762 | Waryfish, (Paperbones) - unidentified | Notosudidae |
| 780 | Wolf-eel | <i>Anarrhichthys ocellatus</i> |
| 781 | Wolffish, Bering | <i>Anarhichas orientalis</i> |
| 829 | Worm - unidentified (flatworms, ribbon worms) | Annelida, Nemertea, Sipuncula, Echiura |
| 759 | Wrymouth Unidentified | Cryptacanthodidae |

* If you encounter these species, please bring a specimen back to NMFS.

Contact NMFS *if you use any species/species group* shown in **Bold Print.**

APPENDIX B: SPECIES CODE LIST - SEABIRDS

| Code | Common Name | Scientific Name |
|-------------|--------------------------------|----------------------------------|
| 849 | Albatross - unidentified | <i>Diomedeidae spp.</i> |
| 852 | Albatross, Black-footed | <i>Phoebastria nigripes</i> |
| 851 | Albatross, Laysan | <i>Phoebastria immutabilis</i> |
| 850 | Albatross, Short-tailed | <i>Phoebastria albatrus</i> |
| 883 | Alcid - unidentified | Alcidae |
| 1101 | Aleutian Tern | <i>Sterna aleutica</i> |
| 1102 | American Pipit | <i>Anthus rubescens</i> |
| 1103 | Ancient Murrelet | <i>Synthliboramphus antiquus</i> |
| 1104 | Arctic Loon | <i>Gavia arctica</i> |
| 1105 | Arctic Tern | <i>Sterna paradisaea</i> |
| 895 | Auklet, Rhinoceros | <i>Cerorhinca moncerata</i> |
| 893 | Auklet/Murrelet - unidentified | Alcidae |
| 1106 | Bald Eagle | <i>Haliaeetus leucocephalus</i> |
| 998 | Bird - unidentified | Aves |
| 1107 | Black Turnstone | <i>Arenaria melanocephala</i> |
| 1108 | Bonaparte's Gull | <i>Larus philadelphia</i> |
| 1109 | Boreal Owl | <i>Aegolius funereus</i> |
| 1110 | Brambling | <i>Fringilla montifringilla</i> |
| 1112 | Canada Goose | <i>Branta canadensis</i> |
| 1111 | Cassin's Auklet | <i>Ptychoramphus aleuticus</i> |
| 1113 | Common Loon | <i>Gavia immer</i> |
| 1114 | Common Merganser | <i>Mergus merganser</i> |
| 1115 | Common Raven | <i>Corvus corax</i> |
| 861 | Cormorant - unidentified | <i>Phalacrocoracidae spp.</i> |
| 1116 | Crested Auklet | <i>Aethia cristatella</i> |
| 1117 | Dovekie | <i>Alle alle</i> |
| 866 | Eider, Common | <i>Somateria mollissima</i> |
| 863 | Eider, King | <i>Somateria spectabilis</i> |
| 864 | Eider, Spectacled | <i>Somateria fischeri</i> |
| 865 | Eider, Steller's | <i>Polysticta stelleri</i> |
| 1118 | Emperor Goose | <i>Chen canagica</i> |
| 1119 | Eskimo Curlew | <i>Numenius borealis</i> |

| Code | Common Name | Scientific Name |
|-------------|----------------------------|-----------------------------------|
| 1120 | Flesh-Footed Shearwater | <i>Puffinus carneipes</i> |
| 1121 | Fork-Tailed Storm-Petrel | <i>Oceanodroma furcata</i> |
| 854 | Fulmar, Northern | <i>Fulmarus glacialis</i> |
| 846 | Grebe - unidentified | Podicipedidae |
| 1100 | Green-Winged Teal | <i>Anas crecca</i> |
| 884 | Guillemot - unidentified | <i>Cephus spp.</i> |
| 874 | Gull - unidentified | Laridae |
| 878 | Gull, Glaucus | <i>Larus hyuperboreus</i> |
| 879 | Gull, Glaucus-winged | <i>Larus glaucescens</i> |
| 877 | Gull, Herring | <i>Larus argentatus</i> |
| 1122 | Gyrfalcon | <i>Falco rusticolus</i> |
| 1123 | Harlequin Duck | <i>Histrionicus histrionicus</i> |
| 1125 | Horned Grebe | <i>Podiceps auritus</i> |
| 1124 | House Finch | <i>Carpodacus mexicanus</i> |
| 871 | Jaeger/Skua - unidentified | <i>Stercorariidae spp.</i> |
| 876 | Kittiwake, Black-legged | <i>Rissa tridactyla</i> |
| 875 | Kittiwake, Red-legged | <i>Rissa brevirostris</i> |
| 898 | Land Bird - unidentified | |
| 1127 | Lapland Longspur | <i>Calcarius lapponicus</i> |
| 851 | Laysan Albatross | <i>Phoebastria immutabilis</i> |
| 1131 | Leach's Storm-Petrel | <i>Oceanodroma leucorhoa</i> |
| 1128 | Least Auklet | <i>Aethia pusilla</i> |
| 1130 | Least Sandpiper | <i>Calidris minutilla</i> |
| 1129 | Lesser Golden-Plover | <i>Pluvialis dominica</i> |
| 1132 | Long-Tailed Duck | <i>Clangula hyemalis</i> |
| 1133 | Long-Tailed Jaeger | <i>Stercorarius longicaudus</i> |
| 844 | Loon - unidentified | Gaviiformes |
| 1135 | Merlin | <i>Falco columbarius</i> |
| 1134 | Mew Gull | <i>Larus canus</i> |
| 1136 | Mottled Petrel | <i>Pterodroma inexpectata</i> |
| 887 | Murre - unidentified | <i>Uria spp.</i> |
| 889 | Murre, Common | <i>Uria aalge</i> |
| 888 | Murre, Thick-billed | <i>Uria lomvia</i> |
| 896 | Murrelet, Kittlitz's | <i>Brachyramphus brevirostris</i> |

| Code | Common Name | Scientific Name |
|-------------|----------------------------------|---------------------------------|
| 894 | Murrelet, Marbled | <i>Brachyramphus marmoratus</i> |
| 893 | Murrelet/Auklet - unidentified | Alcidae |
| 854 | Northern Fulmar | <i>Fulmarus glacialis</i> |
| 1137 | Northern Hawk Owl | <i>Surnia ulula</i> |
| 1138 | Northern Pintail | <i>Anas acuta</i> |
| 1139 | Northern Wheatear | <i>Oenanthe oenanthe</i> |
| 1140 | Osprey | <i>Pandion haliaetus</i> |
| 1141 | Parakeet Auklet | <i>Aethia psittacula</i> |
| 1142 | Parasitic Jaeger | <i>Stercorarius parasiticus</i> |
| 1143 | Pelagic Cormorant | <i>Phalacrocorax pelagicus</i> |
| 1144 | Peregrine Falcon | <i>Falco peregrinus</i> |
| 853 | Petrel/Shearwater - unidentified | Procellariidae |
| 868 | Phalarope - unidentified | Phalaropodidae |
| 1145 | Pomarine Jaeger | <i>Stercorarius pomarinus</i> |
| 890 | Puffin - unidentified | <i>Fratercula spp.</i> |
| 891 | Puffin, Horned | <i>Fratercula corniculata</i> |
| 892 | Puffin, Tufted | <i>Fratercula cirrhata</i> |
| 1147 | Red Phalarope | <i>Phalaropus fulicarius</i> |
| 1148 | Red-Faced Cormorant | <i>Phalacrocorax urile</i> |
| 1149 | Red-Necked Stint | <i>Calidris ruficollis</i> |
| 1146 | Ring-Billed Gull | <i>Larus delawarensis</i> |
| 1152 | Ruddy Turnstone | <i>Arenaria interpres</i> |
| 1151 | Rustic Bunting | <i>Emberiza rustca</i> |
| 1150 | Rusty Blackbird | <i>Euphagus carolinus</i> |
| 1153 | Sabine's Gull | <i>Xema sabini</i> |
| 897 | Seabird - unidentified | |
| 855 | Shearwater, Dark - unidentified | <i>Puffinus spp.</i> |
| 857 | Shearwater, Short-tailed | <i>Puffinus tenuirostris</i> |
| 856 | Shearwater, Sooty | <i>Puffinus griseus</i> |
| 853 | Shearwater/Petrel - unidentified | Procellariidae |
| 867 | Shorebird - unidentified | Charadriiformes |
| 1155 | Short-Eared Owl | <i>Asio flammeus</i> |
| 1156 | Siberian Accentor | <i>Prunella montanella</i> |

| Code | Common Name | Scientific Name |
|-------------|--------------------------------|---------------------------------|
| 871 | Skua/Jaeger - unidentified | <i>Stercorariidae</i> |
| 1154 | Slaty-Backed Gull | <i>Larus schistisagus</i> |
| 1157 | Snowy Owl | <i>Nyctea scandiaca</i> |
| 1159 | South Polar Skua | <i>Stercorarius maccormicki</i> |
| 1158 | Spoonbill Sandpiper | <i>Eurynorhynchus pygmeus</i> |
| 858 | Storm Petrel - unidentified | Hydrobatidae |
| 880 | Tern - unidentified | Sterninae |
| 848 | Tubenoses - unidentified | Procellariiformes |
| 1160 | Unidentified Auklet | Alcidae |
| 1162 | Unidentified Duck | Unidentified Duck |
| 1163 | Unidentified Eider | Aythiinae |
| 1164 | Unidentified Falcon | Falconinae |
| 1165 | Unidentified Hawk | Accipitridae |
| 1166 | Unidentified Kittiwake | Loridae |
| 1167 | Unidentified Murrelet | Alcidae |
| 1168 | Unidentified Owl | Strigidae |
| 1169 | Unidentified Passerine | Passeriformes |
| 1170 | Unidentified Petrel | Hydrobatidae |
| 1161 | Unidentified Plover | Charadriidae |
| 1171 | Unidentified Raptor | Unidentified Raptor |
| 1174 | Unidentified Sandpiper | Scolopacidae |
| 1172 | Unidentified Shorebird | Unidentified Shorebird |
| 1175 | Unidentified Small Dark Auklet | Alcidae |
| 1176 | Unidentified Sparrow | Fringillidae |
| 1173 | Unidentified Warbler | Sylviidae |
| 862 | Waterfowl - unidentified | Anseriformes |
| 1178 | Western Gull | <i>Larus occidentalis</i> |
| 1179 | Whiskered Auklet | <i>Aethia pygmaea</i> |
| 1177 | White-Crowned Sparrow | <i>Zonotrichia leucophrys</i> |
| 1181 | White-Winged Scoter | <i>Melanitta fusca</i> |
| 1180 | Wilson's Warbler | <i>Wilsonia pusilla</i> |
| 1182 | Yellow Wagtail | <i>Motacilla flava</i> |

APPENDIX C: SPECIES CODE LIST - MARINE MAMMALS

| Code | Common Name | Scientific Name |
|-------------|-----------------------------------|-----------------------------------|
| EB | Bearded Seal | <i>Erignathus barbatus</i> |
| ZC | California Sea Lion | <i>Zalophus californianus</i> |
| PV | Harbor Seal | <i>Phoca vitulina</i> |
| MA | Northern Elephant Seal | <i>Mirounga angustirostris</i> |
| CU | Northern Fur Seal | <i>Callorhinus ursinus</i> |
| PF | Ribbon Seal | <i>Histriophoca fasciata</i> |
| PH | Ringed Seal | <i>Pusa hispida</i> |
| PL | Spotted Seal | <i>Phoca largha</i> |
| EJ | Steller Sea Lion | <i>Eumetopias jubatus</i> |
| UO | Unidentified Otariid * | |
| US | Unidentified Phocid * | |
| UP | Unidentified Pinniped * | |
| OR | Walrus | <i>Odobenus rosmarus</i> |
| BE | Baird's Beaked Whale | <i>Berardius bairdii</i> |
| DL | Beluga | <i>Delphinapterus leucas</i> |
| TT | Bottlenose Dolphin | <i>Tursiops truncatus</i> |
| DD | Common Dolphin | <i>Delphinus delphis</i> |
| ZX | Cuvier's Beaked Whale | <i>Ziphius cavirostris</i> |
| PX | Dall's Porpoise | <i>Phocoenoides dalli</i> |
| PC | False Killer Whale | <i>Pseudorca crassidens</i> |
| LH | Fraser's Dolphin | <i>Lagenodelphis hosei</i> |
| PP | Harbor Porpoise | <i>Phocoena phocoena</i> |
| OO | Killer Whale | <i>Orcinus orca</i> |
| MM | Narwhal | <i>Monodon monoceros</i> |
| LB | Northern Righ Whale Dolphin | <i>Lissodelphis borealis</i> |
| LO | Pacific White-sided Dolphin | <i>Lagenorhynchus obliquidens</i> |
| FA | Pygmy Killer Whale | <i>Feresa attenuata</i> |
| GG | Risso's Dolphin | <i>Grampus griseus</i> |
| SB | Rough-toothed Dolphin | <i>Steno bredanensis</i> |
| GM | Shortfin Pilot Whale | <i>Globicephala macrorhynchus</i> |
| PM | Sperm Whale | <i>Physeter macrocephalus</i> |
| SL | Spinner Dolphin | <i>Stenella longirostris</i> |
| SA | Spotted Dolphin (Central Pacific) | <i>Stenella attenuata</i> |
| SG | Spotted Dolphin (Eastern Pacific) | <i>Stenella attenuata</i> |
| MS | Stejneger's Beaked Whale | <i>Mesoplodon stejnegeri</i> |
| SC | Striped Dolphin | <i>Stenella coeruleoalba</i> |
| UD | Unidentified Dolphin/Porpoise | |
| BL | Blue Whale | <i>Balaenoptera musculus</i> |

| Code | Common Name | Scientific Name |
|------|---------------------------|-----------------------------------|
| BM | Bowhead Whale | <i>Balaena mysticetus</i> |
| BX | Bryde's Whale | <i>Balaenoptera edeni</i> |
| BP | Fin Whale | <i>Balaenoptera physalus</i> |
| ER | Gray Whale | <i>Eschrichtius robustus</i> |
| MN | Humpback Whale | <i>Megaptera novaeangliae</i> |
| BA | Minke Whale | <i>Balaenoptera acutorostrata</i> |
| RW | North Pacific Right Whale | <i>Eubalaena japonica</i> |
| BB | Sei Whale | <i>Balaenoptera borealis</i> |
| UC | Unidentified Cetacean * | |
| UZ | Unidentified Large Whale | |
| ZZ | Unidentified Mammal | |
| UX | Unidentified Small Whale | |
| UW | Unidentified Whale | |
| EL | Sea Otter | <i>Enhydra lutris</i> |

* The following characteristics define animals belonging to these groups.

Otariid: This family includes fur seals and sea lions. They have visible, cartilaginous ears, large foreflippers and their hind flippers can be turned under the body. Their flippers are partially furred and they have three claws on their hind flippers, and none on their fore flippers. Males have scrotal testes.

Phocid: These are the true seals. They have no external cartilaginous ears, their small fore flippers are used for guidance only, and their hind flippers cannot be turned under the body. Their flippers are fully furred and five claws on each. Males have internal testes.

Pinniped: This group includes otariids, phocids and the walrus, which has characteristics from both families.

Cetacean: This class includes all whales and porpoises. The body is streamlined with the tail developed into horizontal flukes used for propulsion.

APPENDIX D: ABBREVIATIONS, CONVERSIONS, AND FORMULAS

ABBREVIATIONS

| Unit | symbol | Unit | symbol | Unit | symbol | Unit | symbol |
|---------------|--------|------------|--------|--------|--------|------------|--------|
| inch | in | millimeter | mm | quart | qt | grams | g |
| foot | ft | centimeter | cm | liter | L | kilograms | kg |
| mile | mi | meter | m | minute | min | metric ton | mt |
| fathoms | f | kilometer | km | pounds | lbs | Fahrenheit | F° |
| nautical mile | nm | | | | | Celsius | C° |

CONVERSIONS

| | |
|----------------------------|---|
| 1 in = 2.540 cm | 1 L = 1.0567 qt |
| 1 cm = 10 mm = 0.3937 in | F° = (1.8 x C°) + 32C° = 5/9(F° - 32) |
| 1 ft = 0.3048 m = 0.1667 f | 1 mi = 5,280 ft = 1.609 km = 0.86899 nm = 880 f |
| 1 m = 3.2808 ft = 0.5468 f | 1 nm = 1.15078 mi = 1 min lat = 1.852 km = 1,012.6859 f = 1,852 m |
| 1 f = 6 ft = 1.829 m | 1 f = 0.0009875 nm = 0.0011364 mi |
| 1000 m = 1 km = 0.6214 mi | Decimal minute (also called hundredth of minute) X 60 = Seconds |
| 1 lb = 0.4536 kg | Total catch weight in lbs x 0.4536 = total catch weight in kg |
| 1 mt = 1,000 kg | |

AREA, VOLUME AND PRODUCT FORMULAS

| |
|---|
| Number of Product Units x Average Unit Weight = Total Weight of Product |
| Product Weight ÷ Recovery Rate = Whole Weight of fish used to make the product |
| Product Weight x Conversion Factor = Whole or Fresh Weight of fish used for product |
| Area of a circle = πr^2 Circumference = $2\pi r$ (p = 3.1416) |
| Area of a square or rectangle = length x width |
| Area of a triangle = $\frac{1}{2} \times \text{base} \times \text{height}$ |
| Length of the triangle hypotenuse "c" where a and b equal the length of the opposite two sides: $a^2 + b^2 = c^2$ and $\sqrt{c^2} = c$ |
| Volume of a right angle cone = $\frac{1}{3} \times \pi r^2 h$ |
| Volume of a Sphere = $\frac{4}{3} \times \pi \times r^3$ |
| Volume of a Trapezoid: |

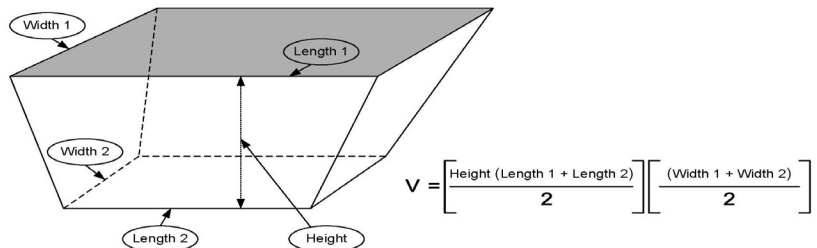

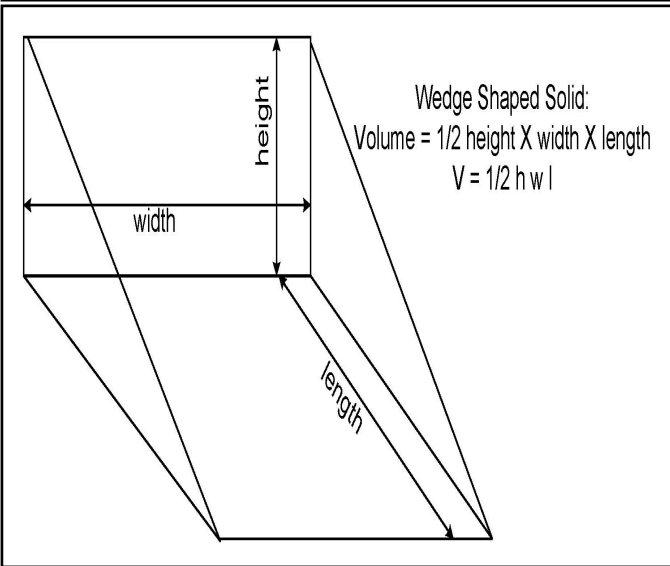
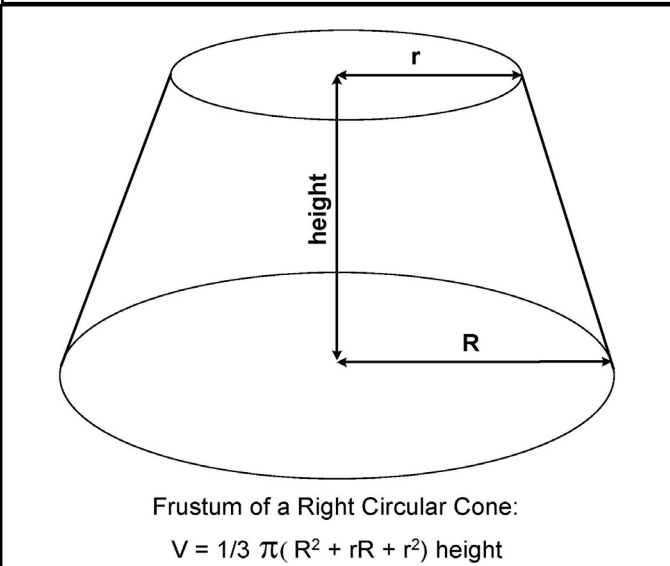
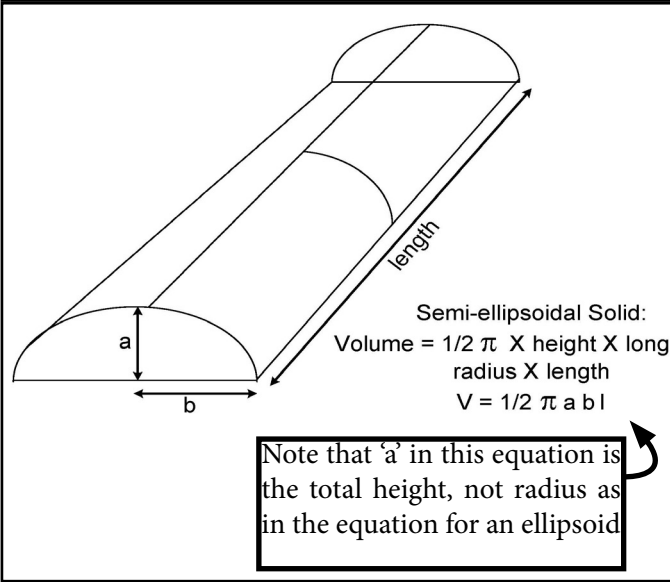
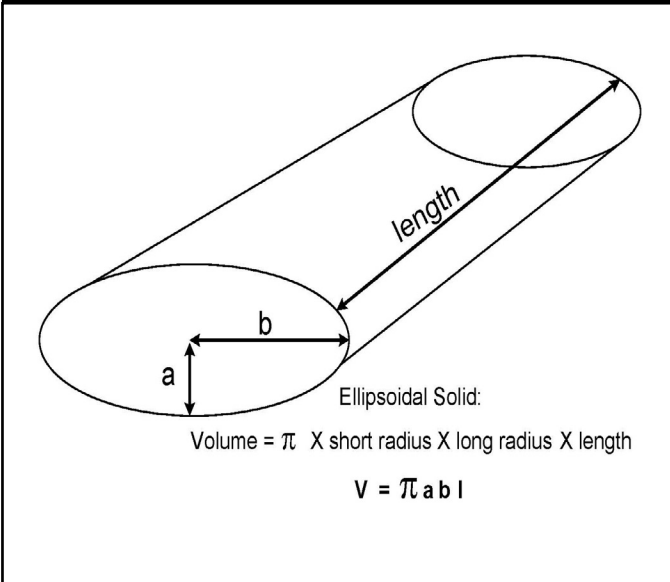
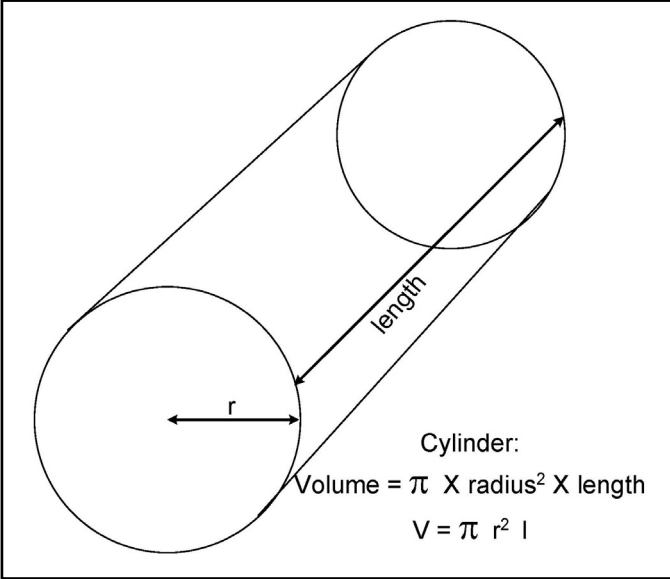
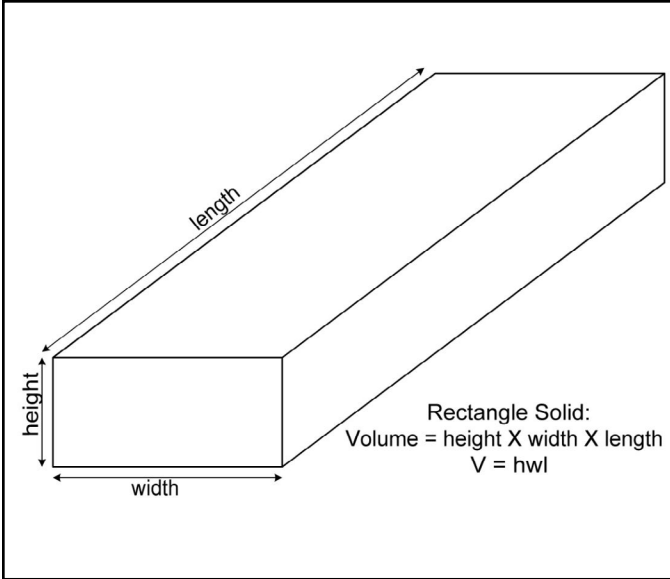

APPENDIX E: RANDOM NUMBER TABLE

| | col. 1 to 5 | col. 6 to 10 | col. 11 to 15 | col. 16 to 20 | col. 21 to 25 | col. 26 to 30 | col. 31 to 35 | col. 36 to 40 | col. 41 to 45 | col. 45 to 50 |
|----|-------------|--------------|---------------|---------------|---------------|---------------|---------------|---------------|---------------|---------------|
| 1 | 5 6 7 2 4 | 0 5 8 7 5 | 1 1 9 6 7 | 9 7 4 8 2 | 6 6 4 1 2 | 8 7 2 1 0 | 1 0 5 1 1 | 6 5 3 8 8 | 2 5 6 3 4 | 9 4 5 7 6 |
| 2 | 0 8 3 5 4 | 9 6 2 0 8 | 2 5 9 9 4 | 9 6 2 6 8 | 2 5 0 9 5 | 6 3 9 5 2 | 4 5 4 3 9 | 3 5 6 8 9 | 0 6 2 8 0 | 3 8 8 2 4 |
| 3 | 8 4 8 8 4 | 4 1 4 0 3 | 7 8 4 6 8 | 3 4 3 9 4 | 2 9 3 2 8 | 3 6 8 5 5 | 3 2 2 0 1 | 7 1 0 2 1 | 9 5 2 4 0 | 7 5 0 2 6 |
| 4 | 1 0 4 3 7 | 1 6 3 1 5 | 2 8 7 6 8 | 2 2 8 5 2 | 7 6 0 4 5 | 0 2 9 1 0 | 8 5 7 0 8 | 7 5 5 7 9 | 2 8 7 3 3 | 2 9 3 5 7 |
| 5 | 6 4 5 9 2 | 5 4 8 9 6 | 4 2 3 2 1 | 2 6 5 5 3 | 4 0 2 0 1 | 1 1 6 1 6 | 1 0 8 2 5 | 2 5 8 7 0 | 7 9 7 8 5 | 5 9 9 9 8 |
| 6 | 3 0 3 5 0 | 8 5 1 0 5 | 3 7 3 2 1 | 7 1 7 9 9 | 9 9 1 3 6 | 8 3 4 5 5 | 1 9 9 4 7 | 9 3 9 9 5 | 8 9 9 0 1 | 1 2 9 2 5 |
| 7 | 1 8 2 6 0 | 5 7 7 4 2 | 9 6 2 2 3 | 1 9 6 7 5 | 5 8 7 1 3 | 4 9 5 1 1 | 8 2 6 1 9 | 3 6 3 5 2 | 4 5 3 1 2 | 6 3 9 6 0 |
| 8 | 2 5 9 2 5 | 5 7 1 4 5 | 4 6 7 6 5 | 1 3 2 3 7 | 3 6 2 2 5 | 4 0 8 6 0 | 7 1 4 8 8 | 3 8 2 3 1 | 2 7 6 0 1 | 6 3 8 5 4 |
| 9 | 9 8 5 8 5 | 6 7 5 3 5 | 3 8 9 4 6 | 7 4 0 4 6 | 1 4 3 6 2 | 9 1 6 8 8 | 4 4 7 3 2 | 2 0 9 0 9 | 5 8 8 4 8 | 2 4 7 9 4 |
| 10 | 2 4 4 8 8 | 0 6 0 2 6 | 4 8 8 3 4 | 3 7 1 7 7 | 0 4 1 2 4 | 0 6 0 8 7 | 1 0 1 7 7 | 9 0 1 7 1 | 5 0 9 9 5 | 4 0 6 0 6 |
| 11 | 6 9 9 8 2 | 8 8 6 6 6 | 5 3 2 9 3 | 4 0 2 7 2 | 7 0 3 2 0 | 7 1 5 3 1 | 8 5 3 9 3 | 7 1 0 0 6 | 7 7 8 4 5 | 1 5 5 6 7 |
| 12 | 6 6 6 3 6 | 9 2 7 7 5 | 0 7 5 4 9 | 7 7 9 7 8 | 7 5 7 3 5 | 7 8 4 6 8 | 6 8 7 4 7 | 7 2 9 6 7 | 3 0 7 9 5 | 7 2 3 1 7 |
| 13 | 8 4 0 2 1 | 1 9 5 0 1 | 5 0 3 6 0 | 6 2 0 1 2 | 2 9 7 4 4 | 0 7 2 5 0 | 5 8 1 1 0 | 5 7 5 8 5 | 9 3 9 2 2 | 5 1 3 7 7 |
| 14 | 5 6 1 4 3 | 4 6 2 0 6 | 5 8 9 0 5 | 3 2 6 7 9 | 4 7 9 9 1 | 2 6 8 9 2 | 3 2 1 5 6 | 3 5 6 0 6 | 6 5 8 9 4 | 3 3 3 5 4 |
| 15 | 9 6 0 4 9 | 0 0 3 7 7 | 3 2 2 9 7 | 8 8 9 0 6 | 6 3 5 6 2 | 2 8 9 1 6 | 7 3 2 6 7 | 7 5 0 2 6 | 2 8 0 1 7 | 0 6 2 6 4 |
| 16 | 7 7 2 2 2 | 1 2 9 0 4 | 5 1 4 5 3 | 9 4 6 5 9 | 6 6 1 1 7 | 7 9 0 6 2 | 5 7 5 4 4 | 7 0 9 6 8 | 5 1 8 9 6 | 6 5 9 6 4 |
| 17 | 3 3 0 5 2 | 5 0 6 3 7 | 4 7 5 9 3 | 8 7 7 4 1 | 4 1 8 3 6 | 7 6 6 3 8 | 9 3 1 4 0 | 0 2 7 2 3 | 5 7 8 2 8 | 8 9 5 7 0 |
| 18 | 4 7 3 3 7 | 0 3 2 0 8 | 8 6 3 0 0 | 7 4 6 3 1 | 8 5 5 6 5 | 0 2 8 1 2 | 3 3 0 5 9 | 7 7 7 8 4 | 6 8 0 2 2 | 7 5 3 1 6 |
| 19 | 8 1 2 4 4 | 4 6 8 2 3 | 2 2 4 8 4 | 3 5 3 0 0 | 7 5 2 3 3 | 7 5 2 4 5 | 8 5 4 9 1 | 3 5 7 2 4 | 3 0 5 7 9 | 5 5 8 0 4 |
| 20 | 8 2 6 0 2 | 8 5 9 6 4 | 6 3 3 6 4 | 8 3 5 4 6 | 6 6 4 8 9 | 5 2 6 5 6 | 1 0 3 0 1 | 5 5 4 4 6 | 8 8 8 4 5 | 8 9 8 3 6 |
| 21 | 1 4 7 8 5 | 0 5 3 4 5 | 9 5 6 3 4 | 6 7 9 0 3 | 0 6 2 6 2 | 9 6 5 6 3 | 4 7 9 7 0 | 9 5 5 7 3 | 6 1 1 1 9 | 3 3 7 4 9 |
| 22 | 5 0 9 5 8 | 2 3 9 1 8 | 4 8 1 1 6 | 9 0 4 3 3 | 0 7 7 1 2 | 4 2 7 8 7 | 9 7 0 5 7 | 0 1 7 1 8 | 7 3 8 4 7 | 4 0 5 8 4 |
| 23 | 4 5 2 2 8 | 1 0 9 9 8 | 3 4 9 3 5 | 2 8 0 0 4 | 7 2 1 8 1 | 8 8 9 3 6 | 0 0 1 1 0 | 4 5 4 2 2 | 9 3 5 3 8 | 3 8 6 1 0 |
| 24 | 0 5 7 7 6 | 6 7 6 4 8 | 3 8 6 1 5 | 0 4 7 4 8 | 1 5 2 4 0 | 3 8 3 4 7 | 2 1 8 7 9 | 9 0 1 2 4 | 2 8 6 6 6 | 3 6 4 3 4 |
| 25 | 2 2 3 1 6 | 2 7 5 6 9 | 1 3 9 5 9 | 3 8 4 7 7 | 8 5 8 9 8 | 9 6 3 5 4 | 1 5 7 2 7 | 8 1 8 1 1 | 5 6 2 9 1 | 3 9 3 8 1 |
| 26 | 1 5 4 7 3 | 7 8 7 7 1 | 5 1 4 3 0 | 6 3 7 4 7 | 6 0 0 7 7 | 1 8 2 8 5 | 5 4 2 3 0 | 8 8 0 0 5 | 6 6 8 4 7 | 0 0 1 0 7 |
| 27 | 2 2 8 4 7 | 0 5 0 0 0 | 6 9 8 2 6 | 3 0 5 9 0 | 6 6 1 3 7 | 8 9 4 9 4 | 3 8 0 3 3 | 5 1 4 0 7 | 0 4 0 1 6 | 5 1 8 9 6 |
| 28 | 9 1 4 0 2 | 7 5 5 0 4 | 2 7 6 1 8 | 7 5 8 2 6 | 5 9 3 8 2 | 5 3 6 8 1 | 5 9 6 9 3 | 0 8 9 2 2 | 3 6 1 0 2 | 3 1 8 1 4 |
| 29 | 8 0 0 1 6 | 1 4 2 8 0 | 0 9 5 2 6 | 3 3 5 3 2 | 0 0 8 4 2 | 7 7 7 7 4 | 1 7 3 0 6 | 3 0 7 7 6 | 6 3 0 1 7 | 0 0 9 3 1 |
| 30 | 3 6 2 8 4 | 6 9 6 6 8 | 6 6 1 8 3 | 8 7 9 0 5 | 9 3 1 8 1 | 6 0 1 5 9 | 7 3 9 9 7 | 3 0 3 5 4 | 5 5 6 3 6 | 0 6 7 6 6 |
| 31 | 0 7 9 2 8 | 1 0 3 4 7 | 9 2 9 0 3 | 6 8 7 2 6 | 0 8 1 4 6 | 1 6 0 0 0 | 3 0 1 7 6 | 0 2 4 5 7 | 0 3 1 7 4 | 0 4 7 4 0 |
| 32 | 5 0 8 3 3 | 1 6 4 1 5 | 7 6 5 4 4 | 4 5 3 6 3 | 4 9 7 6 0 | 6 7 6 0 9 | 3 1 9 7 5 | 9 2 5 2 6 | 1 1 2 1 7 | 5 7 7 3 6 |
| 33 | 1 9 2 7 9 | 8 1 4 8 8 | 4 0 1 6 1 | 4 7 2 5 8 | 6 9 9 5 9 | 7 4 6 3 5 | 2 7 0 4 5 | 5 7 5 8 1 | 1 2 1 7 3 | 6 3 5 8 4 |
| 34 | 1 7 7 3 8 | 1 4 0 4 9 | 6 2 1 0 9 | 4 7 4 4 0 | 3 9 5 1 1 | 7 3 7 8 3 | 6 1 8 8 5 | 4 8 1 0 4 | 6 0 6 2 4 | 6 8 5 8 0 |
| 35 | 7 9 3 4 8 | 3 6 2 4 9 | 8 3 0 2 2 | 9 4 1 9 8 | 0 0 2 3 4 | 7 0 0 4 6 | 2 0 6 1 9 | 9 1 8 5 9 | 7 4 9 6 7 | 2 2 5 2 4 |
| 36 | 0 7 5 7 9 | 4 3 8 7 1 | 6 2 4 6 4 | 6 5 1 2 0 | 4 0 7 9 1 | 7 5 9 9 7 | 6 9 4 4 4 | 7 0 6 1 4 | 1 9 5 3 3 | 4 2 0 2 9 |
| 37 | 5 1 4 2 1 | 8 8 1 7 9 | 5 5 0 8 6 | 9 1 9 6 4 | 5 0 2 8 9 | 2 0 6 9 5 | 6 1 6 9 6 | 3 9 3 7 9 | 5 9 4 9 7 | 2 5 5 5 0 |
| 38 | 5 3 5 8 9 | 6 1 8 2 1 | 9 7 6 3 4 | 2 2 3 1 1 | 3 8 6 2 8 | 7 5 2 4 8 | 5 4 4 8 5 | 1 3 1 1 4 | 0 4 9 1 4 | 7 9 0 2 3 |
| 39 | 2 0 6 5 5 | 1 8 9 1 1 | 6 7 9 7 7 | 6 1 3 0 5 | 0 6 9 0 7 | 8 8 3 3 8 | 4 8 1 7 7 | 1 9 2 1 5 | 3 8 7 4 5 | 1 7 1 6 3 |
| 40 | 6 9 7 2 0 | 7 9 0 3 7 | 2 4 5 6 1 | 3 7 4 2 6 | 8 0 6 9 2 | 9 3 0 2 3 | 9 9 5 8 4 | 8 7 4 4 5 | 1 0 0 3 5 | 0 9 2 9 0 |
| 41 | 8 8 7 6 8 | 5 4 9 9 6 | 0 8 6 7 0 | 7 5 3 0 4 | 0 1 0 3 0 | 2 4 9 4 5 | 6 7 4 4 0 | 5 6 7 7 3 | 5 6 4 0 2 | 1 7 5 1 8 |
| 42 | 9 2 8 8 6 | 0 5 6 4 0 | 5 7 9 3 7 | 8 8 7 5 5 | 2 8 1 4 0 | 3 0 7 8 9 | 9 8 0 1 2 | 2 3 1 4 2 | 1 0 9 0 0 | 7 7 9 0 2 |
| 43 | 9 9 1 6 9 | 2 8 2 3 9 | 2 6 8 0 1 | 7 1 4 6 9 | 0 5 5 5 0 | 1 8 3 5 4 | 8 7 0 5 8 | 8 5 8 4 1 | 2 5 0 1 4 | 0 2 0 6 9 |
| 44 | 7 5 4 9 5 | 6 7 1 5 0 | 5 1 5 0 9 | 1 8 2 3 6 | 1 1 1 7 9 | 5 5 2 8 5 | 4 2 4 2 3 | 0 1 9 1 3 | 1 6 4 2 2 | 8 5 9 4 2 |
| 45 | 4 5 0 7 8 | 0 5 4 0 3 | 4 4 8 8 3 | 1 3 6 2 4 | 4 6 6 1 6 | 5 5 2 0 2 | 0 5 7 1 7 | 5 7 7 2 0 | 9 9 1 9 1 | 3 4 1 3 0 |
| 46 | 7 6 0 8 8 | 6 8 7 3 6 | 5 3 7 7 5 | 9 9 6 6 2 | 3 6 1 9 2 | 8 5 2 8 1 | 6 8 2 3 0 | 2 9 5 4 6 | 7 2 9 6 0 | 6 5 0 0 5 |
| 47 | 6 1 3 5 8 | 8 1 5 6 7 | 9 5 7 7 2 | 2 8 9 4 5 | 1 9 6 9 5 | 2 0 6 9 1 | 6 2 6 1 4 | 0 6 0 7 9 | 7 6 4 0 2 | 9 9 5 2 3 |
| 48 | 7 9 0 8 0 | 7 4 0 3 0 | 6 6 5 1 7 | 2 5 4 0 5 | 2 8 0 1 5 | 3 9 9 9 2 | 2 1 8 7 1 | 5 8 1 9 5 | 7 6 9 1 6 | 2 1 9 8 8 |
| 49 | 2 4 3 6 4 | 5 6 5 3 2 | 2 0 9 1 7 | 9 8 5 8 3 | 5 5 4 9 4 | 1 2 1 9 2 | 9 5 5 1 9 | 7 4 8 5 5 | 7 1 3 3 0 | 7 6 2 7 9 |
| 50 | 7 4 6 5 4 | 1 5 7 4 8 | 0 0 8 3 1 | 3 0 2 2 4 | 0 9 9 6 2 | 6 7 1 7 7 | 5 4 2 4 2 | 5 6 1 6 6 | 1 6 6 9 0 | 1 4 2 0 3 |

APPENDIX F: PRODUCT RECOVERY RATES (PRR)

Product recovery rate (PRR) represents that proportion of an organism that is used for product. The PRR is also referred to as the recovery ratio. Recovery rates can be used for estimating the fresh weight of a catch from the tonnage of product produced. The following equation can be used for estimating round weight from product weight. *Remember to add in discards.*

$$(\text{product weight} \div \text{recovery rate}) = \text{round weight (before processing)}$$

Recovery rates are commonly expressed as a percent or as a ratio. Headed and gutted cod may have a recovery ratio of 0.62 to 1, or 62% recovery, while fish frozen whole would have a recovery ratio of 1.00 to 1, or 100% recovery. The weight of product divided by the weight of the fish before processing is the recovery ratio. The fish weighed before processing should be sorted to species and be of the size and condition needed for the product.

$$(\text{product weight} \div \text{round weight}) = \text{product recovery rate}$$

The product weight as defined here assumes 100% efficiency in production. If fifty fish are weighed before processing, the product weight should represent the product from all fifty fish. If the product weight is less, because of loss along the production line, the result should be called an efficiency ratio rather than a product recovery ratio.

A wide range of recovery rates are used to describe the utilization of different species in a variety of products. The type of processing, the size of the fish, the area and season of the year, the experience of the processing crew, and the vessel type all have a bearing on the recovery rate of a particular species.

A conversion factor is a number which can be multiplied times the product weight to obtain the round weight (whole weight of the fish). *A conversion factor is always greater than 1* (for example, the conversion factor of surimi weight to pollock weight maybe 6.67). To convert a conversion factor to a recovery rate, take the reciprocal of the conversion factor, (i.e., divide the number 1 by the conversion factor).

| FMP Group | NMFS Group Codes | Product Code | | | | | | | | | | | | | | | | | | | | | | | | | | | | | | | | | | |
|-------------|------------------|--------------|------|------|------|------|------|------|------|------|------|------|------|------|------|------|------|------|------|------|------|------|------|------|-----|----|--|--|--|--|--|--|--|--|--|--|
| | | 3 | 4 | 6 | 7 | 8 | 10 | 11 | 12 | 13 | 14 | 15 | 16 | 17 | 18 | 19 | 20 | 21 | 22 | 23 | 24 | 30 | 31 | 32 | 36 | 37 | | | | | | | | | | |
| P.cod | 110 | 0.98 | 0.85 | 0.63 | 0.57 | 0.47 | 0.44 | --- | 0.45 | --- | 0.05 | 0.05 | --- | 0.01 | 0.45 | 0.35 | 0.25 | 0.25 | --- | 0.15 | 0.50 | 0.17 | --- | 0.43 | | | | | | | | | | | | |
| SWF | 119 | 0.98 | 0.90 | 0.80 | 0.72 | 0.65 | 0.62 | 0.48 | --- | --- | 0.08 | --- | --- | --- | 0.32 | 0.27 | 0.22 | 0.22 | --- | --- | --- | 0.17 | --- | --- | | | | | | | | | | | | |
| Oflat | 120 | 0.98 | 0.90 | 0.80 | 0.72 | 0.65 | 0.62 | 0.48 | --- | --- | 0.08 | --- | --- | --- | 0.32 | 0.27 | 0.22 | 0.22 | --- | --- | --- | 0.17 | --- | --- | | | | | | | | | | | | |
| arrowtooth | 121 | 0.98 | 0.90 | 0.80 | 0.72 | 0.65 | 0.62 | 0.48 | --- | --- | 0.08 | --- | --- | --- | 0.32 | 0.27 | 0.22 | 0.22 | --- | --- | --- | 0.17 | --- | --- | | | | | | | | | | | | |
| flathead | 122 | 0.98 | 0.90 | 0.80 | 0.72 | 0.65 | 0.62 | 0.48 | --- | --- | 0.08 | --- | --- | --- | 0.32 | 0.27 | 0.22 | 0.22 | --- | --- | --- | 0.17 | --- | --- | | | | | | | | | | | | |
| rock sole | 123 | 0.98 | 0.90 | 0.80 | 0.72 | 0.65 | 0.62 | 0.48 | --- | --- | 0.08 | --- | --- | --- | 0.32 | 0.27 | 0.22 | 0.22 | --- | --- | --- | 0.17 | --- | --- | | | | | | | | | | | | |
| Dover | 124 | 0.98 | 0.90 | 0.80 | 0.72 | 0.65 | 0.62 | 0.48 | --- | --- | 0.08 | --- | --- | --- | 0.32 | 0.27 | 0.22 | 0.22 | --- | --- | --- | 0.17 | --- | --- | | | | | | | | | | | | |
| rex | 125 | 0.98 | 0.90 | 0.80 | 0.72 | 0.65 | 0.62 | 0.48 | --- | --- | 0.08 | --- | --- | --- | 0.32 | 0.27 | 0.22 | 0.22 | --- | --- | --- | 0.17 | --- | --- | | | | | | | | | | | | |
| YFS | 127 | 0.98 | 0.90 | 0.80 | 0.72 | 0.65 | 0.62 | 0.48 | --- | --- | 0.08 | --- | --- | --- | 0.32 | 0.27 | 0.22 | 0.22 | --- | 0.18 | --- | 0.17 | --- | --- | | | | | | | | | | | | |
| Turbot | 134 | 0.98 | 0.90 | 0.80 | 0.72 | 0.65 | 0.62 | 0.48 | --- | --- | 0.08 | --- | --- | --- | 0.32 | 0.27 | 0.22 | 0.22 | --- | --- | --- | 0.17 | --- | --- | | | | | | | | | | | | |
| thornyheads | 143 | 0.98 | 0.88 | 0.55 | 0.60 | 0.50 | --- | --- | --- | --- | --- | 0.20 | 0.05 | 0.05 | 0.05 | 0.40 | 0.30 | 0.35 | 0.25 | --- | --- | 0.17 | --- | --- | | | | | | | | | | | | |
| sculpins | 160 | 0.98 | 0.87 | --- | 0.50 | 0.40 | --- | --- | --- | --- | --- | --- | --- | --- | --- | --- | --- | --- | --- | --- | --- | 0.17 | --- | --- | | | | | | | | | | | | |
| Atka | 193 | 0.98 | 0.87 | 0.67 | 0.64 | 0.61 | --- | --- | --- | --- | --- | --- | --- | --- | --- | --- | --- | --- | --- | --- | 0.15 | --- | 0.17 | --- | --- | | | | | | | | | | | |
| pollock | 270-A* | 0.98 | 0.80 | 0.70 | 0.65 | 0.56 | 0.50 | 0.25 | --- | --- | 0.07 | 0.15 | --- | --- | 0.35 | 0.3 | 0.21 | 0.21 | 0.16 | 0.16 | 0.22 | 0.17 | --- | 0.43 | | | | | | | | | | | | |
| | 270-B** | 0.98 | 0.80 | 0.70 | 0.65 | 0.56 | 0.50 | 0.25 | --- | --- | 0.07 | 0.15 | --- | --- | 0.35 | 0.3 | 0.21 | 0.21 | 0.16 | 0.16 | 0.22 | 0.17 | --- | 0.43 | | | | | | | | | | | | |
| smelts | 510 | 0.98 | 0.82 | --- | 0.71 | --- | --- | --- | --- | --- | --- | --- | --- | --- | 0.38 | --- | --- | --- | --- | --- | --- | 0.17 | --- | --- | | | | | | | | | | | | |
| eulachon | 511 | 0.98 | 0.82 | --- | 0.71 | --- | --- | --- | --- | --- | --- | --- | --- | --- | 0.38 | --- | --- | --- | --- | --- | --- | 0.17 | --- | --- | | | | | | | | | | | | |
| capelin | 516 | 0.98 | 0.89 | --- | 0.78 | --- | --- | --- | --- | --- | --- | --- | --- | --- | --- | --- | --- | --- | --- | --- | --- | 0.17 | --- | --- | | | | | | | | | | | | |
| sharks | 689 | 0.98 | 0.83 | --- | 0.72 | --- | --- | --- | --- | --- | --- | --- | --- | --- | 0.3 | 0.3 | 0.25 | 0.25 | --- | --- | --- | 0.17 | --- | --- | | | | | | | | | | | | |
| skates | 700 | 0.98 | 0.90 | --- | --- | 0.32 | --- | --- | --- | 0.32 | --- | --- | --- | --- | --- | --- | --- | --- | --- | --- | --- | 0.17 | --- | --- | | | | | | | | | | | | |
| sablefish | 710 | 0.98 | 0.89 | --- | 0.68 | 0.63 | 0.50 | --- | --- | --- | --- | --- | 0.05 | --- | 0.35 | 0.3 | 0.25 | 0.25 | --- | --- | --- | 0.17 | --- | --- | | | | | | | | | | | | |
| octopus | 870 | 0.98 | 0.81 | --- | --- | --- | --- | --- | --- | --- | --- | --- | --- | --- | --- | --- | --- | --- | --- | --- | --- | 0.17 | --- | 0.85 | | | | | | | | | | | | |
| squid | 875 | 0.98 | 0.69 | --- | --- | --- | --- | --- | --- | --- | --- | --- | --- | --- | --- | --- | --- | --- | --- | --- | --- | 0.17 | --- | 0.75 | | | | | | | | | | | | |
| rockfish | --- | 0.98 | 0.88 | --- | 0.6 | 0.5 | --- | --- | --- | --- | --- | 0.15 | 0.05 | 0.05 | 0.1 | 0.4 | 0.3 | 0.33 | 0.25 | --- | --- | --- | --- | --- | | | | | | | | | | | | |

* Standard pollock surimi rate during January through June

** Standard pollock surimi rate during July through December

APPENDIX G: PRODUCT CODES AND DESCRIPTION

| Code | Description | Code | Description |
|------|--|------|--|
| 1 | Whole fish/food fish (PRR = 1.00) | 32 | Fish meal (meal from whole fish or fish parts, includes bone meal) |
| 3 | Bled only (throat slit to allow blood to drain) | 33 | Fish oil |
| 4 | Gutted only (head on, belly slit and viscera removed) | 34 | Milt (in sacs, or testes - ancillary product only) |
| 5 | Gutted, head off (headed/gutted) - IFQ halibut only | 35 | Stomachs (includes all internal organs-ancillary product only) |
| 6 | H & G, with roe | 36 | Octopus/squid mantles (flesh after removal of viscera and arms) |
| 7 | H & G, Western cut (head removed in front of pectoral girdle) | 37 | Butterfly (split, no backbone, head removed, fillets still attached) |
| 8 | H & G, Eastern cut (head removed behind pectoral girdle) | 39 | Bones (ancillary product only) |
| 10 | H & G, tail removed (usually a Western cut with tail also removed) | 41 | Fish destined for fish meal (PRR=1.00) |
| 11 | Kirimi (head, gut and tail removed by cuts perpendicular to spine) | 60 | Sold for human consumption |
| 12 | Salted and split | 61 | Sold for bait |
| 13 | Wings (from skates, side fins are cut off next to body) | 62 | Overage |
| 14 | Roe only (eggs, either loose or in sacs or skeins) | 63 | Confiscated or seized |
| 15 | Pectoral girdle only (collar bone and associated bones, cartilage and flesh -ancillary product only) | 64 | Tagged IFQ fish |
| 16 | Heads (heads only, regardless where severed ancillary product only) | 86 | Donated prohibited species, food bank program |
| 17 | Cheeks (muscles on sides of head - ancillary product only) | 87 | Retained for future sale |
| 18 | Chins (lower jaw (mandible), muscles and flesh - ancillary product only) | 88 | Discarded, infested |
| 19 | Belly (flesh in region of pelvic and pectoral fins and behind head - ancillary product only) | 89 | Decomposed or previously discarded |
| 20 | Fillets with skin and ribs | 92 | Retained for bait - not sold |
| 21 | Fillets with skin, no ribs | 93 | Damaged by observer sampling |
| 22 | Fillets, with ribs, no skin | 95 | Personal use - not sold |
| 23 | Fillets, skinless/boneless | 97 | Other retained product - specify condition |
| 24 | Deep skin fillets | 98 | Discard at sea |
| 30 | Surimi (paste from any of the fish flesh and additives) | 99 | Discard, onshore - after delivery/before processing - not sold |
| 31 | Minced fish | | |

For a complete list of product codes see <https://elandings.alaska.gov/elandings/conditiondispositionlookup>

APPENDIX H: NMFS SPECIES AND GROUP CODES USED IN VESSEL LOGBOOKS

| Species or Group Code | Species or Group Description |
|------------------------------|---|
| 193 | Atka mackerel |
| 121 | Arrowtooth flounder and/or Kamchatka flounder |
| 870 | Octopus |
| 110 | Pacific cod |
| 270 | Pollock |
| 122 | Flathead sole |
| 123 | Rock sole (includes northern, southern and unidentified rock soles) |
| 124 | Dover sole |
| 125 | Rex sole |
| 127 | Yellowfin sole |
| 134 | Turbot (Greenland) |
| 143 | Thornyheads (all <i>Sebastolobus</i> species) |
| 160 | Sculpins |
| 511 | Eulachon |
| 516 | Capelin |
| 689 | Sharks (general) |
| 700 | Skates (general) |
| 710 | Sablefish |
| 875 | Squid |
| Group Code 118 | Shallow water flatfish complex (SWF) in the Gulf of Alaska (includes yellowfin sole, rock soles, English sole, starry flounder, butter sole, Alaska plaice and sand sole). |
| Group Code 120 | Other Flatfish (OFLAT) (All flatfish without a separate code (e.g., petrale sole) |
| 130 | Lingcod (non-allocated species) |
| 136 | Northern rockfish |
| Group Code 168 | Demersal shelf rockfish (canary, china, copper, quillback, rosethorn, tiger and yellow-eye) |
| Group Code 169 | Pelagic shelf rockfish (dusky, yellowtail and widow) |
| Group Code 144 | Slope rockfish (aurora, blackgill, Bocaccio, chilipepper, darkblotch, green-striped, harlequin, pygmy, redbanded, redstripe, sharpchin, shortbelly, silvergray, splitnose, stripetail, vermillion, and yellowmouth) |
| 141 | Pacific ocean perch |
| 151 | Rougheye rockfish |
| 152 | Shortraker rockfish |

APPENDIX I: ALASKA DEPARTMENT OF FISH AND GAME FISH TICKET CODES

| Code | Species | Code | Species | Code | Species | Code | Species |
|------|------------------------|------|-------------------------------------|------|---------------------------|------|------------------------------------|
| 110 | cod, Pacific (gray) | 160 | sculpin, general | 430 | salmon, coho | 830 | clam, razor |
| 121 | flounder, arrowtooth | 166 | rockfish, sharpchin | 440 | salmon, pink | 840 | clam, little-neck |
| 122 | sole, flathead | 167 | rockfish, blue | 450 | salmon, chum | 842 | clam, eastern softshell |
| 123 | sole, rock | 170 | sardine, Pacific | 511 | smelt, eulachon | 850 | scallop, weathervane |
| 124 | sole, dover | 175 | rockfish, yellowmouth | 515 | smelt, surf | 851 | scallop, pink (or calico) |
| 125 | sole, rex | 176 | rockfish, harlequin | 516 | smelt, capelin | 855 | blue mussel |
| 126 | sole, butter | 177 | rockfish, blackgill | 521 | Arctic char | 860 | abalone |
| 127 | sole, yellowfin | 178 | rockfish, chillipepper | 531 | Dolly Varden | 870 | octopus |
| 128 | sole, english | 179 | rockfish, pygmy | 540 | trout, steelhead | 875 | squid |
| 129 | flounder, starry | 180 | shad | 600 | lamprey, Pacific | 890 | snails |
| 130 | lingcod | 181 | rockfish, shortbelly | 625 | jellyfish | 892 | urchin, red sea |
| 131 | sole, petrale | 182 | rockfish, splitnose | 680 | sturgeon, general | 893 | urchin, green sea |
| 132 | sole, sand | 183 | rockfish, stripetail | 689 | shark, general | 895 | sea cucumber |
| 133 | plaice, Alaska | 184 | rockfish, vermilion | 690 | shark, salmon | 899 | coral |
| 134 | turbot, Greenland | 185 | rockfish, aurora | 691 | shark, spiny dogfish | 900 | crab, box |
| 135 | rockfish, greenstripe | 191 | greenling, rock | 692 | shark, Pacific sleeper | 910 | crab, Dungeness |
| 136 | rockfish, northern | 192 | greenling, whitespot | 700 | skate, general | 921 | crab, red king |
| 137 | rockfish, bocaccio | 193 | greenling, atka mackerel | 701 | skate, longnose | 922 | crab, blue king |
| 138 | rockfish, copper | 194 | greenling, kelp | 703 | skate, Alaska | 923 | crab, brown king (golden) |
| 141 | perch, Pacific Ocean | 200 | halibut | 710 | sablefish (blackcod) | 924 | crab, scarlet king (couesi) |
| 142 | rockfish, black | 210 | eels or eel-like fish | 714 | ratfish | 931 | crab, Tanner, bairdi |
| 143 | rockfish, thornyhead | 211 | wrymouths | 715 | skilfish | 932 | crab, Tanner, opilio |
| 145 | rockfish, yelloweye | 212 | hagfish, Pacific | 720 | albacore | 933 | crab, Tanner, grooved (tanneri) |
| 146 | rockfish, canary | 213 | grenadier (rattail) | | <u>Forage Fish</u> | 934 | crab, Tanner, triangle (angulatus) |
| 147 | rockfish, quillback | 214 | grenadier (giant) | 206 | Pacific sand fish | 940 | crab, korean horsehair |
| 148 | rockfish, tiger | 215 | prowfish | 207 | gunnel | 951 | crab, multispina |
| 149 | rockfish, China | 216 | lumpsucker | 208 | prickleback | 953 | crab, verrilli |
| 150 | rockfish, rosethorn | 220 | saury, Pacific | 209 | bristlemouth | 961 | shrimp, pink |
| 151 | rockfish, rougheye | 230 | herring, Pacific (directed fishery) | 772 | lanternfish | 962 | shrimp, sidestripe |
| 152 | rockfish, shortraker | 235 | herring, Pacific (bycatch) | 773 | deep-sea smelt | 963 | shrimp, humpy |
| 153 | rockfish, redbanded | 250 | tomcod, Pacific | 774 | Pacific sand lance | 964 | shrimp, coonstripe |
| 154 | rockfish, dusky | 260 | Pacific Flatnose | 800 | krill | 965 | shrimp, spot |
| 155 | rockfish, yellowtail | 270 | pollock, walleye | | <u>Shellfish</u> | | |
| 156 | rockfish, widow | 400 | salmon, roe | 810 | clam, butter | | |
| 157 | rockfish, silvergray | 410 | salmon, chinook | 812 | clam, surf | | |
| 158 | rockfish, redstripe | 420 | salmon, sockeye | 815 | clam, geoduck | | |
| 159 | rockfish, darkblotched | | | 820 | clam, cockle | | |

APPENDIX J. PORT CODES AND NON-FISHING DAY PORT POSITIONS

| Port Codes and Non-Fishing Day Port Positions Enter the appropriate port code on your Trip Form. If you are in one of the ports listed below, you may use the positions for non-fishing days on the Vessel Haul Form. | | | | | | | | |
|--|--------------|---------------|--------------------|--------------|---------------|----------------------------|----------|-----------|
| CODE/NAME | Latitude | Longitude | CODE/NAME | Latitude | Longitude | CODE/NAME | Latitude | Longitude |
| 1-Adak | 51 53 | 176 39 | 31-Hyder | 55 55 | 130 01 | 99-Seldovia | 59 26 | 151 43 |
| 10-Akutan | 54 08 | 165 46 | 4-Juneau | 58 10 | 134 18 | 7-Seward | 60 07 | 149 27 |
| 2-Alitak | 56 53 | 154 07 | 82-Kake | 56 58 | 133 56 | 16-Sitka | 57 03 | 135 20 |
| 56-Anchor Point | 59 46 | 151 46 | 83-Kaltag | 64 20 | 158 44 | 100-Skagway | 59 27 | 135 19 |
| 70-Anchorage | 61 13 | 149 54 | 32-Kasilof | 60 20 | 151 14 | 39-Soldotna | 60 29 | 151 05 |
| 57-Angoon | 57 30 | 134 34 | 33-Kenai | 60 34 | 151 14 | 101-St. George | 56 36 | 169 34 |
| 72-Aniak | 61 35 | 159 33 | 84-Kenai River | 60 30 | 150 32 | 102-St. Mary | 62 03 | 163 13 |
| 58-Anvik | 62 39 | 160 13 | 13-Ketchikan | 55 21 | 131 40 | 8-St. Paul | 57 09 | 170 13 |
| 21-Atka | 52 12 | 174 13 | 5-King Cove | 55 03 | 162 19 | 19-Tacoma | 47 14 | 122 28 |
| 73-Auke Bay | 58 23 | 134 40 | 67-King Salmon | 58 41 | 156 39 | 103-Tee Harbor | 58 25 | 134 45 |
| 74-Beaver Inlet | 53 44 | 166 19 | 50-Kipnuk | 59 56 | 164 03 | 104-Tenakee Springs | 57 47 | 135 13 |
| 20-Bellingham | 48 45 | 122 29 | 52-Klawock | 55 33 | 133 05 | 41-Togiak | 59 04 | 160 23 |
| 59-Bethel | 60 48 | 161 46 | 14-Kodiak | 57 42 | 152 15 | 46-Toksook | 60 32 | 165 06 |
| 48-Chefornak | 60 10 | 164 16 | 85-Kotzebue | 66 54 | 162 35 | 18-TRANSFER AT SEA* | | |
| 22-Chignik | 56 18 | 158 24 | 34-Larsen Bay | 57 32 | 153 59 | 47-Tununak | 60 35 | 165 16 |
| 60-Chitina | 61 31 | 144 26 | 45-Mekoryuk | 60 23 | 166 12 | 105-Ugashik | 57 32 | 157 16 |
| 61-Chugiak | 58 11 | 134 15 | 35-Metlakatla | 55 08 | 131 35 | 106-Unalakleet | 63 53 | 160 47 |
| 62-Clam Gulch | 60 14 | 151 24 | 86-Moser Bay | 57 02 | 154 09 | 42-Valdez | 61 08 | 146 21 |
| 63-Coffman Cove | 56 01 | 132 50 | 36-Naknek | 58 44 | 156 58 | 43-Whittier | 60 46 | 148 41 |
| 64-Copper Center | 61 58 | 145 19 | 87-Nenana | 64 33 | 149 05 | 44-Wrangell | 56 23 | 132 05 |
| 11-Cordova | 60 33 | 145 45 | 68-Nikiski | 60 42 | 151 16 | 9-Yakutat | 59 33 | 139 44 |
| 23-Craig | 55 29 | 133 08 | 54-Ninilichik | 60 03 | 151 40 | | | |
| 24-Dillingham | 59 03 | 158 31 | 37-Nome | 64 30 | 165 24 | | | |
| 65-Douglas | 58 17 | 134 24 | 88-Nunivak Island | 60 07 | 166 35 | | | |
| 3-Dutch Harbor | 53 53 | 166 32 | 51-Old Harbor | 57 12 | 153 18 | | | |
| 25-Egegik | 58 13 | 157 22 | 17-OTHER* | | | | | |
| 69-Ekuk | 58 48 | 158 34 | 55-Palmer | 61 36 | 149 07 | | | |
| 66-Elfin Cove | 58 12 | 136 21 | 89-Pelican | 57 57 | 136 13 | | | |
| 53-Emmonak | 62 47 | 164 33 | 38-Petersburg | 56 48 | 132 57 | | | |
| 108-Everett | 47 58 | 122 12 | 90-Port Alexander | 56 14 | 134 39 | | | |
| 26-Excursion Inlet | 58 25 | 135 25 | 91-Port Armstrong | 56 18 | 134 40 | | | |
| 27-False Pass | 54 50 | 163 24 | 92-Port Bailey | 57 56 | 153 02 | | | |
| 78-Galena | 64 44 | 156 53 | 93-Port Graham | 59 21 | 151 50 | | | |
| 79-Glacier Bay | 58 41 | 136 11 | 94-Port Lions | 57 52 | 152 53 | | | |
| 80-Glennallen | 62 07 | 145 33 | 95-Port Moller | 56 00 | 160 34 | | | |
| 28-Gustavus | 58 25 | 135 45 | 96-Port Protection | 56 19 | 133 36 | | | |
| 29-Haines | 59 14 | 135 27 | 97-Quinhagak | 59 45 | 161 54 | | | |
| 12-Homer | 59 38 | 151 33 | 6-Sand Point | 55 20 | 160 03 | | | |
| 30-Hoonah | 58 07 | 135 26 | 40-Savoonga | 63 42 | 170 28 | | | |
| 49-Hooper Bay | 61 32 | 166 06 | 15-Seattle | 47 42 | 122 13 | | | |
| 81-Hydaburg | 55 12 | 132 49 | 98-Selawik | 66 36 | 160 01 | | | |

*Trip Codes- If the vessel is docked at a port, floating processor, trawler, or tender that is not listed in the table, use the "Other" code. If you use the "Other" code, you must enter position data in the trip start and/or trip end position columns. For at-sea transfers, use code 18 and enter position data.

This page intentionally left blank

APPENDIX K: PROCESSOR PERMIT LIST

| Processor | Location | Permit | Processor | Location | Permit |
|--|----------------|--------|--|-------------------|--------|
| Non-Federal Permit Buyer | | 99998 | Gorden Jenson | | 5293 |
| Unknown Location | | 99999 | Homer Fish Processing | Homer | 8553 |
| 60 Degrees North Seafoods | Corvoda | 34834 | Hooked Seafood Company Alaska | Juneau | 34822 |
| Absolute Fresh Seafoods, Inc. | Seattle | 29501 | Hoonah Cold Storage | Hoonah | 32927 |
| Adak Cod Cooperative | Adak | 33575 | Icicle Sfds - Seward Fisheries | Seward | 5299 |
| Alaska Fresh Seafoods Inc. (a.k.a. Star of Kodiak-Trident) | Kodiak | 27990 | Icy Bay | Yakutat | 3417 |
| Alaska General Seafoods | Ketchikan | 31258 | Independence | | 3259 |
| Alaska Glacier Seafood Co. | Juneau | 5945 | Island Fish Co | Kodiak | 28695 |
| Alaska Pacific Seafood | Kodiak | 5342 | Kachemak Bay Seafood | Homer | 5302 |
| Alaskan Fish Factory Ltd | Soldotna | 34505 | Kake Foods | Kake | 32671 |
| Alaskan Premier Seafoods | Hyder | 5797 | Katie Ann | | 1996 |
| Aleutian Island Fish Company | Dutch | 34748 | Kodiak Pillar Mountain (Trident Seafoods). | Kodiak | 33969 |
| Alyeska Seafoods Inc. | Unalaska | 5320 | Kodiak Smoking & Processing | Kodiak | 30877 |
| Atka Pride Seafoods Inc. | Atka | 5303 | North Point Fisheries, Inc. | King Cove | 34556 |
| Auction Block (The) | Homer & Seward | 6053 | Northern Fish Alaska LLC | Cordova | 33746 |
| Bering Pacific Seafoods | | 18671 | Northern Victor | | 4078 |
| Bering Star | | 3531 | Norton Sound Eco Dev Corp | Nome | 25535 |
| Carroll Corporation | Homer | 30456 | Norton Sound Eco Dev Corp | Savoonga | 30814 |
| Coal Point Trading Co | Homer | 5520 | Norton Sound Economic Sfd - Nome | Nome | 30813 |
| Coastal Cold Storage | Petersburg | 5435 | Noyes Island Smokehouse | Craig | 34308 |
| Copper River Sfds - Anchorage | Anchorage | 28721 | OBI Seafoods - Kodiak | Kodiak | 35479 |
| Copper River Sfds - Cordova | Cordova | 6293 | OBI Seafoods - Petersburg | Petersburg | 35387 |
| Copper River Sfds - Kenai | Kenai | 32824 | OBI Seafoods LLC-Seward | Seward | 35388 |
| Dangerous Cape | | 33156 | Ocean Beauty Polar Sfds | Seward | 29550 |
| Dejon Delights | Haines | 34929 | Ocean Beauty Seafoods Inc. | Alitak, SW Kodiak | 30884 |
| Dutch Harbor Acquisitions/ Bering Fisheries, LLC | Dutch Harbor | 32181 | Ocean Beauty Seafoods Inc. | Cordova | 30885 |
| E&E Foods Inc Db a Yakutat Seafoods | Yakutat | 34548 | Ocean Beauty Seafoods Inc. | Excursion Inlet | 30886 |
| E.C. Phillips And Son - Craig | Craig | 31357 | Ocean Beauty Seafoods Inc. | Kodiak, AK | 30883 |
| E.C. Phillips And Son - Ketchikan | Ketchikan | 5376 | Ocean Cape Facility | Yakutat | 34548 |
| FAVCO | Anchorage | 5383 | Pacific Seafoods Kodiak Plant | Kodiak | 5390 |
| Fee's Custom Seafoods | Anchorage | 28197 | Pacific Star Seafoods Inc. | Kenai | 5442 |
| Fish Factory | Homer | 26030 | Peter Pan LLC | King Cove | 35448 |
| Fish From Trish | Ketchikan | 33659 | Peter Pan Sfds | Cold Bay | 34556 |
| Glacier Fresh Salmon | Yakutat | 29503 | Peter Pan Seafoods Inc. | Valdez | 5357 |
| Global Seafoods | Kodiak | 27989 | Petersburg Fisheries (Icicle Seafoods) | Petersburg | 5300 |
| Golden Alaska | | 1607 | Premier Harvest | Bellingham | 34486 |
| Golden Harvest | Adak | 34707 | Prime Select Seafood Inc. | Cordova | 5423 |

| Processor | Location | Permit |
|---|--------------------|--------|
| Pure Pacific Seafood, Inc. | Seattle | 34565 |
| Resurrection Bay Seafood | Seward | 30131 |
| RM Thorstenson | Floating Processor | 5362 |
| Sea Aleutians Seafoods, LLC | Dutch Harbor | 33603 |
| Sea Level Sfds (Resurrection Bay Sfds) - Seward | Seward | 30131 |
| Sea Level Seafoods | Wrangell | 5523 |
| Seaborn Seafood, LLC | Craig | 34907 |
| Seafood Producers Cooperative | Sitka | 5371 |
| Seward Fisheries (Icicle Seafoods) | Seward | 5299 |
| Silver Bay Seafoods | False Pass | 35011 |
| Silver Bay Sfds - Kodiak | Kodiak | 35457 |
| Silver Bay Seafoods | Sitka | 31740 |
| Sitka Salmon Shares | Sitka | 34140 |
| Sitka Sound Seafoods | Sitka | 5346 |
| Snow Pass Seafoods | Coffman Cove | 8086 |
| Snow Pass Seafoods | Craig | 31823 |
| Snug Harbor Seafoods | Seward | 7124 |
| Star of Kodiak (Trident Seafoods) | Kodiak | 27990 |
| Sunaq Tribal Enterprises, INC | Kodiak | 32684 |

| Processor | Location | Permit |
|---|-----------------|--------|
| Taku Smokeries | Juneau | 27991 |
| Tonka Seafoods | Petersburg | 7061 |
| Togiak Fisheries | Togiak | 26247 |
| Togiak Seafoods, LLC | Togiak | 31991 |
| Tonka Seafoods | Petersburg | 7061 |
| Trident Sfds (170 Degrees West) - St. Paul | St Paul | 32926 |
| Trident Seafoods Corp. | Akutan | 5306 |
| Trident Seafoods (DBA Norquest Seafoods) | Cordova | 30483 |
| Trident Seafoods-Ketchikan Cannery | Ketchikan | 30485 |
| Trident Seafoods | Petersburg | 30482 |
| Trident Seafoods Corp. | Sand Point | 5305 |
| Trident Seafoods Corp. | St. Paul Island | 5307 |
| Unisea Inc. - Dutch Harbor | Dutch Harbor | 5310 |
| Unknown Location | | 99999 |
| Western Alaska Fisheries (Westward Seafoods). | Kodiak | 29502 |
| Westward Seafoods Inc. | Dutch Harbor | 5323 |
| Yakobi Fisheries | Pelican | 33980 |
| Yakutat Seafoods, LLC | Yakutat | 29504 |

APPENDIX L: VESSEL NAMES AND PERMIT NUMBERS

| Vessel Name | ADFG # | NMFS permit # | Length |
|--------------------|--------|---------------|--------|
| ACE | 77957 | 33828 | 49 |
| ADAMANT | 89178 | 33305 | 58 |
| ADELYN L | 37706 | 563 | 54 |
| ADVANCER | 40762 | 4628 | 58 |
| AFOGNAK STRAIT | 76858 | 32783 | 58 |
| AGILE | 19741 | 202 | 48 |
| AK ASSASSIN | 72462 | 18777 | 45 |
| ALASKA | 33276 | 1361 | 48 |
| ALASKA BEAUTY | 22011 | 2046 | 98 |
| ALASKA CHALLENGER | 4100 | 3387 | 99 |
| ALASKA CHIEFTAN | 61223 | 4543 | 108 |
| ALASKA DAWN | 69765 | 6097 | 90 |
| ALASKA ENDEAVOR | 8500 | 6202 | 130 |
| ALASKA JURIS | 54693 | 2443 | 238 |
| ALASKA MIST | 54851 | 2833 | 174 |
| ALASKA OCEAN | 60407 | 3794 | 376 |
| ALASKA ROSE | 38989 | 515 | 124 |
| ALASKA SPIRIT - CV | 35949 | 4105 | 98 |
| ALASKA SPIRIT - CP | 59870 | 3819 | 221 |
| ALASKA VICTORY | 61083 | 4093 | 227 |
| ALASKA WARRIOR | 56965 | 3423 | 215 |
| ALASKAN | 3734 | 2010 | 73 |
| ALASKAN DEFENDER | 41312 | 425 | 172 |
| ALASKAN DREAM | 75343 | 30898 | 58 |
| ALASKAN FRONTIER | 61324 | 4649 | 58 |
| ALASKAN GIRL | 41089 | 362 | 65 |
| ALASKAN LADY - CV | 26280 | 1889 | 58 |
| ALASKAN LADY - CP | 61538 | 4306 | 180 |
| ALASKAN LADY - CV | 64766 | 5196 | 41 |
| ALASKAN LEADER | 62437 | 4598 | 150 |
| ALASKAN LEGACY | 77916 | 33785 | 57 |
| ALASKAN PATRIOT | 77105 | 33045 | 88 |
| ALASKAN STAR | 76584 | 32429 | 58 |
| ALDEBARAN | 48215 | 901 | 132 |
| ALEUT LADY | 56169 | 25080 | 54 |
| ALEUT MISTRESS | 41035 | 2348 | 58 |
| ALEUTIAN BEAUTY | 32282 | 4638 | 98 |
| ALEUTIAN BELLE | 52037 | 1564 | 58 |
| ALEUTIAN DREAM | 25218 | 5190 | 49 |
| ALEUTIAN ENDURANCE | 79091 | 35424 | 58 |
| ALEUTIAN ISLE | 23257 | 5086 | 58 |

| Vessel Name | ADFG # | NMFS permit # | Length |
|------------------|--------|---------------|--------|
| ALEUTIAN LADY | 56126 | 4102 | 165 |
| ALEUTIAN MARINER | 35844 | 495 | 118 |
| ALEUTIAN SABLE | 72318 | 7161 | 124 |
| ALEUTIAN SPIRIT | 40128 | 2743 | 58 |
| ALEUTIAN STAR | 41906 | 5284 | 48 |
| ALEUTIAN SUN | 40273 | 16247 | 57 |
| ALEXANDRA | 44071 | 1483 | 42 |
| ALITAK | 62694 | 5017 | 50 |
| ALLEGIANCE | 61800 | 4727 | 47 |
| ALLIANCE | 53535 | 3081 | 51 |
| ALLSTAR | 55922 | 2111 | 59 |
| ALMAZ | 56234 | 4515 | 40 |
| ALRITA | 12658 | 52 | 73 |
| ALSEA | 40749 | 2811 | 124 |
| ALYESKA | 45 | 395 | 122 |
| ALYSA JUNE | 61634 | 11843 | 58 |
| AMBASSADOR | 38728 | 6245 | 48 |
| AMBITION | 61801 | 4491 | 43 |
| AMERICAN BEAUTY | 24255 | 1688 | 123 |
| AMERICAN DYNASTY | 59378 | 3681 | 272 |
| AMERICAN EAGLE | 39 | 434 | 120 |
| AMERICAN NO I | 36202 | 1879 | 160 |
| AMERICAN TRIUMPH | 60660 | 4055 | 285 |
| AMERICANUS | 56390 | 3443 | 42 |
| AMERICAS FINEST | 78724 | 34969 | 264 |
| ANAPILAR | 45416 | 25013 | 48 |
| ANCHOR POINT | 63361 | 26620 | 42 |
| ANDRONICA | 39926 | 4560 | 92 |
| ANGEJENL | 41330 | 3017 | 53 |
| ANGELETTE | 38948 | 244 | 58 |
| ANGELIQUE | 16155 | 2108 | 56 |
| ANITA | 77547 | 33571 | 57 |
| ANITA J | 29 | 1913 | 130 |
| ANN | 19882 | 2658 | 44 |
| ANNA D | 21809 | 1987 | 50 |
| ANNA LANE | 26304 | 3244 | 63 |
| ANNE LOUISE | 37788 | 4157 | 47 |
| ANTHEM | 76842 | 32761 | 57 |
| APRIL LANE | 77934 | 33807 | 56 |
| ARAOHO | 77812 | 34017 | 194 |
| ARBITER | 55949 | 2255 | 40 |

| Vessel Name | ADFG # | NMFS permit # | Length |
|-------------------|--------|---------------|--------|
| ARCHANGEL | 55900 | 2173 | 54 |
| ARCTIC BEAR | 43207 | 2902 | 47 |
| ARCTIC EXPLORER | 57440 | 3388 | 155 |
| ARCTIC FJORD | 57450 | 3396 | 275 |
| ARCTIC HUNTER | 32554 | 1550 | 102 |
| ARCTIC ICE | 38727 | 337 | 58 |
| ARCTIC LADY | 37210 | 2841 | 133 |
| ARCTIC MARINER | 31792 | 4582 | 125 |
| ARCTIC PROWLER | 77470 | 33470 | 136 |
| ARCTIC RAM | 57117 | 523 | 90 |
| ARCTIC STORM - CP | 54886 | 2943 | 334 |
| ARCTIC STORM - CV | 66700 | 5599 | 58 |
| ARCTIC WIND | 1112 | 5137 | 106 |
| ARCTURUS | 45978 | 533 | 132 |
| ARGOSY | 38547 | 2810 | 124 |
| ARIANNA SAGE | 77241 | 33207 | 57 |
| ARICA | 57228 | 3694 | 186 |
| ARIEL | 35842 | 1313 | 44 |
| ARIZONA | 54959 | 3497 | 41 |
| ARLICE | 7317 | 76 | 54 |
| ARROW | 4346 | 97 | 70 |
| ATKA PRIDE | 75426 | 31033 | 53 |
| ATLANTICO | 37 | 625 | 98 |
| ATLAS | 76293 | 32140 | 54 |
| AUGUSTINE | 42232 | 3093 | 90 |
| AURIGA | 56153 | 2889 | 193 |
| AURORA | 56154 | 2888 | 193 |
| AUTOMATIC | 60144 | 3873 | 41 |
| AVALANCHE | 53170 | 4024 | 40 |
| AWTAM | 99 | 5762 | 42 |
| B.C. SUMMERS | 79061 | 35367 | 46 |
| BALLYHOO | 3645 | 1921 | 176 |
| BALTIC | 18723 | 148 | 52 |
| BARANOF | 34855 | 1248 | 180 |
| BARBARA B | 19500 | 18197 | 49 |
| BARBARA J | 44971 | 4979 | 110 |
| BAY ISLANDER | 49618 | 1193 | 86 |
| BEARCLAW | 34902 | 2928 | 40 |
| BEAUTY BAY | 60100 | 4533 | 124 |
| BELLADAWN | 74786 | 30187 | 54 |
| BERGEN | 18879 | 1247 | 58 |
| BERING DEFENDER | 51672 | 2047 | 174 |

| Vessel Name | ADFG # | NMFS permit # | Length |
|------------------|--------|---------------|--------|
| BERING HUNTER | 60865 | 5571 | 119 |
| BERING LEADER | 74669 | 29997 | 124 |
| BERING PROWLER | 63333 | 4540 | 124 |
| BERING ROSE | 40638 | 516 | 124 |
| BERING SEA | 52 | 3380 | 114 |
| BERING STAR | 4147 | 4658 | 108 |
| BIG BLUE | 37241 | 1907 | 88 |
| BILLIKIN | 20745 | 277 | 135 |
| BLACK PEARL | 75679 | 31325 | 51 |
| BLUE ATTU | 40837 | 4377 | 135 |
| BLUE CHIP II | 61777 | 26071 | 42 |
| BLUE DOLPHIN | 32352 | 391 | 47 |
| BLUE GADUS | 62933 | 2090 | 152 |
| BLUE NORTH | 77788 | 33989 | 191 |
| BLUE PACIFIC | 62905 | 4618 | 180 |
| BLUEBERRY | 57659 | 3488 | 42 |
| BLUEJACKET | 16844 | 10845 | 46 |
| BOLD PACIFIC | 43268 | 1660 | 58 |
| BOUNTIFUL | 34053 | 278 | 165 |
| BRANDI RAE LYN | 58690 | 4416 | 40 |
| BRAVADO | 72787 | 27435 | 59 |
| BREAKER | 66848 | 24617 | 58 |
| BREAKERS EDGE | 61783 | 6070 | 58 |
| BRENN A | 38923 | 3407 | 107 |
| BRISTOL EXPLORER | 55923 | 3007 | 180 |
| BRISTOL LEADER | 70435 | 6323 | 167 |
| BRISTOL MARINER | 8411 | 5448 | 125 |
| BRUIN | 47952 | 1630 | 58 |
| BUCCANEER | 25 | 1106 | 76 |
| BUCK & ANN | 32862 | 509 | 56 |
| BULLDOG | 131 | 4106 | 132 |
| C RAINE | 53333 | 2048 | 47 |
| CAITLIN ANN | 59779 | 3800 | 103 |
| CAMELOT | 57850 | 4414 | 42 |
| CAMERON | 41628 | 2292 | 58 |
| CANDIDA DAWN C | 36100 | 5379 | 42 |
| CAPE BLANCO | 62878 | 4623 | 50 |
| CAPE CAUTION | 46309 | 5382 | 108 |
| CAPE CHEERFUL | 35052 | 2604 | 58 |
| CAPE CROSS | 38534 | 4690 | 46 |
| CAPE FALCON | 16740 | 468 | 56 |
| CAPE FLATTERY | 76583 | 32448 | 57 |

| Vessel Name | ADFG # | NMFS permit # | Length |
|-----------------|--------|---------------|--------|
| CAPE HORN | 55921 | 2110 | 158 |
| CAPE KALEKTA | 36339 | 1768 | 46 |
| CAPE KIWANDA | 61432 | 1235 | 85 |
| CAPE PROVIDENCE | 32424 | 19861 | 42 |
| CAPE RELIANT | 65119 | 15532 | 58 |
| CAPE ST ELIAS | 9185 | 10562 | 58 |
| CAPTAIN COOK | 29869 | 26124 | 48 |
| CAPTAIN KIDD | 67659 | 6008 | 58 |
| CAPT SAM | 59482 | 4395 | 50 |
| CARAVELLE | 57634 | 3402 | 86 |
| CARIBOU | 36141 | 1626 | 48 |
| CARLYNN | 39737 | 3717 | 55 |
| CAROL ANN | 22410 | 17223 | 42 |
| CAROLE D | 27013 | 1946 | 48 |
| CAROLINE | 19773 | 4154 | 42 |
| CAROLYN L | 269 | 1133 | 44 |
| CASCADE | 54954 | 3410 | 40 |
| CASCADE | 76935 | 32850 | 48 |
| CASINO | 27080 | 1524 | 47 |
| CASSANDRA LYNN | 37849 | 11350 | 41 |
| CASTAWAY | 25535 | 2332 | 54 |
| CASTLE CAPE | 39191 | 1762 | 48 |
| CAYMAN ISLE | 78187 | 34324 | 42 |
| CELTIC | 57469 | 3474 | 58 |
| CERULEAN | 77211 | 33530 | 56 |
| CEST LA VIE | 50533 | 5129 | 44 |
| CHALLENGER | 57627 | 16907 | 48 |
| CHAMPION | 78528 | 34744 | 43 |
| CHANCY | 27438 | 6074 | 46 |
| CHANDALAR | 55675 | 5747 | 70 |
| CHANNA SEA | 22816 | 2233 | 77 |
| CHARITY | 39288 | 5880 | 46 |
| CHARLES T | 18613 | 3547 | 59 |
| CHARLEY | 78536 | 34794 | 60 |
| CHASIN DREAMS | 77184 | 33147 | 47 |
| CHATHAM | 57734 | 14593 | 39 |
| CHELLISSA | 70459 | 6222 | 70 |
| CHELSEA DAWN | 32833 | 4189 | 58 |
| CHELSEA K | 62906 | 4620 | 150 |
| CHERI D | 23193 | 3470 | 46 |
| CHEROKEE | 44450 | 1664 | 54 |
| CHIKAMIN | 32562 | 3795 | 58 |

| Vessel Name | ADFG # | NMFS permit # | Length |
|--------------------|--------|---------------|--------|
| CHINA COVE | 45450 | 780 | 43 |
| CHINIAK | 13 | 3762 | 48 |
| CHISIK ISLAND | 12512 | 18179 | 82 |
| CHOPAKA | 68231 | 5911 | 43 |
| CHRISTI ROB | 31691 | 11160 | 46 |
| CHRISTINA DAWN | 37431 | 1308 | 56 |
| CINDRIA GENE | 58183 | 4173 | 58 |
| CINNABAR | 54402 | 5583 | 43 |
| CINNAMON GIRL | 22718 | 153 | 58 |
| CLAIRE OCEANA | 76477 | 32333 | 58 |
| CLARENA | 19866 | 2136 | 41 |
| CLIPPER ENDEAVOR | 56602 | 3242 | 128 |
| CLIPPER EPIC | 38549 | 4463 | 172 |
| CLIPPER SURPRISE | 54743 | 2718 | 128 |
| CLOUD NINE | 61269 | 5826 | 54 |
| CLYDE | 55803 | 2391 | 58 |
| COLLIER BROTHERS | 54648 | 2791 | 95 |
| COLUMBIA | 39056 | 1228 | 123 |
| COMET | 70128 | 14312 | 43 |
| COMMANDER | 25928 | 2084 | 58 |
| COMMITMENT | 24592 | 3412 | 58 |
| COMMITMENT | 32320 | 15245 | 42 |
| COMMODORE | 53843 | 2657 | 133 |
| COMPETITION | 46029 | 918 | 48 |
| CONCORD | 59706 | 4630 | 41 |
| CONFIDENCE | 6946 | 4980 | 100 |
| CONQUEST | 65420 | 5172 | 46 |
| CONSTANCE | 39870 | 2437 | 46 |
| CONSTELLATION - CP | 61081 | 4092 | 166 |
| CONTENDER | 44107 | 2871 | 48 |
| CORA J | 47911 | 4636 | 58 |
| CORAL | 67358 | 5892 | 43 |
| CORAL LEE | 61667 | 4222 | 57 |
| CORAL SEA | 56409 | 14792 | 40 |
| CORMORANT ISLE | 73777 | 28050 | 54 |
| COURAGEOUS | 35833 | 1276 | 180 |
| COURTNEY NORAL | 62901 | 4579 | 58 |
| CRUSADER | 24316 | 1729 | 50 |
| CUB POINT | 40130 | 2066 | 45 |
| CURRENCY | 58382 | 3997 | 46 |
| CYNOSURE | 76034 | 31775 | 58 |
| DANEGELD | 71757 | 14972 | 46 |

| Vessel Name | ADFG # | NMFS permit # | Length |
|----------------|--------|---------------|--------|
| DANGEROUS CAPE | 77199 | 33156 | 58 |
| DAS BOOT | 64054 | 5034 | 43 |
| DAWN | 9206 | 5 | 92 |
| DAWNTREADER | 52729 | 15000 | 45 |
| DAY STAR | 30587 | 26796 | 58 |
| DAYBREAK | 46571 | 1270 | 42 |
| DAYSRING | 60569 | 16479 | 40 |
| DECISION | 62844 | 4614 | 58 |
| DEEP PACIFIC | 56016 | 2872 | 124 |
| DEFENDER - CV | 50908 | 1472 | 45 |
| DEFENDER - CP | 62545 | 4635 | 123 |
| DEFENDER - CV | 78139 | 34279 | 169 |
| DEFIANCE | 78616 | 34839 | 43 |
| DEFIANT | 40141 | 2198 | 66 |
| DELIVERANCE | 5721 | 2124 | 58 |
| DELTA | 58255 | 4343 | 41 |
| DENA INA | 38719 | 641 | 47 |
| DESIRAE DAWN | 35563 | 2135 | 53 |
| DESTINATION | 42234 | 5329 | 109 |
| DESTINATION | 60655 | 3988 | 180 |
| DEVOTION | 42892 | 21644 | 58 |
| DEVYN NICOLE | 61688 | 1415 | 47 |
| DIANA JEAN | 78500 | 34724 | 55 |
| DISCOVERY | 51761 | 2317 | 58 |
| DISCOVERY | 58077 | 4029 | 42 |
| DOLPHIN | 40179 | 2534 | 50 |
| DOLPHIN | 59796 | 3829 | 44 |
| DOMINATOR | 8668 | 411 | 124 |
| DOMINION | 61304 | 25961 | 55 |
| DRAKE | 56133 | 2940 | 43 |
| DREAM GIRL | 72378 | 19860 | 48 |
| DREAM MAID | 19359 | 1782 | 58 |
| DUSK | 21636 | 4 | 86 |
| DYNASTY | 63937 | 5052 | 43 |
| EARLY TIMES | 48866 | 5210 | 40 |
| ECLIPSE | 36750 | 1849 | 40 |
| EL DORADO | 20248 | 4419 | 49 |
| EL TIBURON | 27462 | 86 | 52 |
| ELINOR JANE | 24315 | 1126 | 46 |
| ELINORE J | 35306 | 1114 | 111 |
| ELIZABETH F | 14767 | 823 | 90 |
| ELIZABETH S | 47192 | 976 | 47 |

| Vessel Name | ADFG # | NMFS permit # | Length |
|-------------------|--------|---------------|--------|
| EMILY NICOLE | 62925 | 4663 | 58 |
| EMILY ROSE | 37824 | 5808 | 50 |
| EMILY ROSE | 57986 | 3419 | 55 |
| EMPRESS | 56704 | 3418 | 58 |
| ENDURANCE | 34512 | 166 | 58 |
| ENDURANCE | 37866 | 5058 | 47 |
| ENTERPRISE - CV | 20339 | 2579 | 78 |
| ENTERPRISE - CP | 69038 | 5822 | 120 |
| ENTRANCE POINT | 46496 | 5417 | 97 |
| EQUINOX | 61679 | 4208 | 58 |
| ERICA RENEE | 62608 | 13313 | 51 |
| ERIKA ANN | 45052 | 5083 | 58 |
| ETHEL FRANCES | 57937 | 3439 | 42 |
| EVENING STAR | 35608 | 200 | 65 |
| EVIE GRACE | 78702 | 34939 | 78 |
| EXCALIBUR II | 54653 | 410 | 92 |
| EXCELLENCE | 60958 | 4111 | 367 |
| EXODUS | 59121 | 3728 | 53 |
| EXPATRIATE | 61311 | 4655 | 58 |
| FAIRWIND | 59340 | 3763 | 48 |
| FAITH | 27326 | 568 | 52 |
| FALCON | 56099 | 2911 | 59 |
| FAMILY PRIDE | 10167 | 248 | 58 |
| FARRAR SEA | 61954 | 5478 | 100 |
| FARWEST LEADER | 35683 | 3226 | 101 |
| FAZAN | 35896 | 3803 | 40 |
| FIERCE ALLEGIANCE | 55111 | 4133 | 166 |
| FLICKA | 78412 | 34615 | 140 |
| FLYING OCEAN | 41215 | 4284 | 98 |
| FORTUNE | 31796 | 926 | 45 |
| FRAM | 56187 | 10669 | 50 |
| FREYJA | 38913 | 1314 | 58 |
| FREYJA DAWN | 43565 | 3662 | 49 |
| FRIGIDLAND | 14895 | 4853 | 75 |
| FRISIAN LADY | 77923 | 33794 | 58 |
| FRONTIER EXPLORER | 62169 | 4450 | 135 |
| FRONTIER MARINER | 59380 | 3672 | 135 |
| FRONTIER SPIRIT | 59381 | 3673 | 135 |
| GAFF RK | 11963 | 562 | 46 |
| GALATEA | 25505 | 155 | 55 |
| GAMBLER | 60038 | 4498 | 40 |
| GAMBLER | 61605 | 4573 | 116 |

| Vessel Name | ADFG # | NMFS permit # | Length |
|-----------------|--------|---------------|--------|
| GARNET C | 18402 | 1031 | 50 |
| GIDEON | 60840 | 4254 | 42 |
| GINNY O | 24228 | 17889 | 58 |
| GLACIER | 56249 | 5206 | 42 |
| GLACIER BAY | 34905 | 5325 | 154 |
| GLADIATOR | 32473 | 1318 | 124 |
| GLENNETTE C | 53375 | 4705 | 50 |
| GOLD RUSH | 40309 | 1868 | 99 |
| GOLDEN ALASKA | 52929 | 1607 | 305 |
| GOLDEN CHALICE | 59771 | 360 | 57 |
| GOLDEN DAWN | 35687 | 1292 | 149 |
| GOLDEN FLEECE | 43260 | 367 | 104 |
| GOLDEN PISCES | 32817 | 586 | 98 |
| GRANT | 19262 | 289 | 68 |
| GREAT PACIFIC | 37660 | 511 | 124 |
| GUARDIAN | 61571 | 4627 | 99 |
| GULF MAIDEN | 12796 | 1591 | 72 |
| GULF PROWLER | 39369 | 1632 | 110 |
| HAAKON | 45949 | 2623 | 53 |
| HADASSAH | 26020 | 14557 | 58 |
| HALCYON | 78919 | 35073 | 58 |
| HALEY MARIE | 51047 | 2396 | 49 |
| HALF MOON BAY | 39230 | 249 | 122 |
| HANNAH POINT | 71619 | 7117 | 46 |
| HANS HALVOR | 72345 | 7177 | 58 |
| HAPPY TIME | 76764 | 32695 | 41 |
| HARDY | 17987 | 2128 | 44 |
| HARVEST | 32383 | 15955 | 41 |
| HAVEN | 18335 | 5363 | 45 |
| HEATHER D | 33266 | 15918 | 48 |
| HEATHER LEE | 66360 | 13529 | 43 |
| HEATHER MARGENE | 21312 | 4141 | 58 |
| HELEN DELL | 21948 | 2559 | 42 |
| HELEN T | 17291 | 1102 | 45 |
| HELM POINT | 11592 | 5009 | 41 |
| HICKORY WIND | 47795 | 993 | 107 |
| HIGH VOLTAGE | 77234 | 33200 | 45 |
| HIGHLINER | 58108 | 3533 | 41 |
| HORIZON | 57820 | 21418 | 42 |
| HOTSPUR | 57843 | 3815 | 58 |
| HOYDEN | 36870 | 3510 | 46 |
| HUKILAU | 69007 | 6253 | 58 |

| Vessel Name | ADFG # | NMFS permit # | Length |
|-------------------|--------|---------------|--------|
| HULA GIRL | 29447 | 25929 | 59 |
| ICELANDER | 2 | 2730 | 100 |
| ICY MIST | 75998 | 31729 | 58 |
| ICY QUEEN | 19847 | 2584 | 58 |
| IDA JUNE | 26017 | 1170 | 52 |
| IDA LEE | 22721 | 1681 | 52 |
| ILONA B | 37833 | 2333 | 56 |
| INDEPENDENCE | 22756 | 792 | 78 |
| INDIGO | 22778 | 4360 | 52 |
| INSATIABLE | 78238 | 34389 | 57 |
| INTANGIBLE | 89173 | 31518 | 58 |
| INTREPID | 61743 | 4327 | 43 |
| INTREPID | 75701 | 31364 | 58 |
| INUA | 46570 | 1860 | 54 |
| INVESTOR | 55617 | 14022 | 40 |
| INVISIBLE | 75465 | 31061 | 48 |
| IRENE H | 6710 | 2899 | 82 |
| ISLAND ENTERPRISE | 59503 | 3870 | 312 |
| ISLAND PRIDE | 53349 | 2225 | 58 |
| ISLE DOMINATOR | 77327 | 33363 | 58 |
| JACK COTANT | 58308 | 10842 | 44 |
| JAEGER | 31159 | 1144 | 46 |
| JANENE | 51030 | 2168 | 44 |
| JANI K | 53570 | 1895 | 54 |
| JANIS M | 17688 | 193 | 50 |
| JEAN C | 55419 | 2069 | 58 |
| JEANINE KATHLEEN | 61272 | 4195 | 58 |
| JEANNIE IRENE | 77769 | 33961 | 49 |
| JEANOAH | 14963 | 1497 | 82 |
| JENNIFER LEE | 41043 | 2867 | 58 |
| JERRY O | 19514 | 5734 | 46 |
| JERSEY GIRL | 33175 | 10729 | 50 |
| JETTA D | 25481 | 11721 | 43 |
| JOANN MARIE | 35138 | 1285 | 60 |
| JODI MARIE | 30374 | 26563 | 58 |
| JOMEL | 36358 | 2011 | 46 |
| JON K | 33298 | 557 | 46 |
| JUDY MAY | 46464 | 6010 | 40 |
| JULIA BREEZE | 45842 | 1375 | 53 |
| JULIE ANN | 28384 | 5579 | 47 |
| JUST IN CASE | 41044 | 4212 | 58 |
| KAIA | 57935 | 20204 | 53 |

| Vessel Name | ADFG # | NMFS permit # | Length |
|-------------------|--------|---------------|--------|
| KAIA | 76787 | 32693 | 58 |
| KAIJA V | 43822 | 4725 | 42 |
| KALEVA | 72430 | 19591 | 40 |
| KALLISTE | 58727 | 4388 | 57 |
| KANERVA | 45479 | 17677 | 57 |
| KAPITAN | 53989 | 3535 | 41 |
| KARELIA | 74788 | 30175 | 56 |
| KAREN ANN | 39787 | 12563 | 42 |
| KAREN EVICH | 46701 | 3713 | 58 |
| KAREN JEAN | 17944 | 2125 | 58 |
| KARIEL | 59918 | 3759 | 66 |
| KARMA | 17124 | 22585 | 58 |
| KATHI | 30611 | 5072 | 48 |
| KATHLEEN JO | 32380 | 611 | 54 |
| KATIE ANN | 55301 | 1996 | 296 |
| KATIE J | 31248 | 1801 | 47 |
| KATIE JEAN | 42874 | 1967 | 42 |
| KATIE LYNN | 35418 | 667 | 51 |
| KATRINA | 26337 | 1 | 52 |
| KATRINA EM | 38972 | 1980 | 101 |
| KAYSIE | 54988 | 4275 | 41 |
| KEALAILANI | 62761 | 30649 | 45 |
| KELLY MARIE | 37609 | 2431 | 48 |
| KELSEY | 56017 | 4591 | 43 |
| KELTIE | 22640 | 18601 | 58 |
| KEMA SUE | 41033 | 1701 | 80 |
| KETA | 7189 | 5330 | 97 |
| KEVLEEN K | 960 | 4769 | 104 |
| KILOKAK | 50994 | 15956 | 48 |
| KIMBER | 20162 | 151 | 58 |
| KINGFISHER | 75661 | 31377 | 50 |
| KODIAK | 3525 | 1109 | 111 |
| KODIAK ENTERPRISE | 59170 | 3671 | 275 |
| KOKOMO | 57707 | 4816 | 46 |
| KONA KAI | 51347 | 2342 | 112 |
| KRISTIANA | 19044 | 576 | 69 |
| KRISTIN BELL | 41236 | 12602 | 44 |
| KRISTINA | 12547 | 1450 | 57 |
| KRUZOF | 69054 | 6039 | 59 |
| KUSTATAN | 60210 | 5489 | 100 |
| LADY ALASKA | 61351 | 4978 | 138 |
| LADY ANN | 35787 | 10158 | 47 |

| Vessel Name | ADFG # | NMFS permit # | Length |
|----------------|--------|---------------|--------|
| LADY BARBARA | 49319 | 7263 | 47 |
| LADY J | 27790 | 4355 | 49 |
| LADY JANE | 23081 | 3570 | 49 |
| LADY JANE | 31482 | 2949 | 42 |
| LADY JO | 30866 | 334 | 48 |
| LADY JOANNE | 62922 | 4657 | 58 |
| LADY LEE DAWN | 41401 | 3734 | 58 |
| LADY RUTH | 26288 | 1877 | 51 |
| LADY SIMPSON | 30601 | 2129 | 105 |
| LADY SOLVAY | 56788 | 3548 | 42 |
| LARA LEE | 59150 | 1939 | 52 |
| LARISA M | 28268 | 3543 | 56 |
| LAST ONE | 59770 | 4733 | 47 |
| LAURA | 21591 | 1571 | 93 |
| LAURA S | 29390 | 2177 | 58 |
| LEGACY | 48183 | 3367 | 132 |
| LEGASEA | 67511 | 14302 | 51 |
| LESLEY ANN | 15369 | 21 | 46 |
| LESLIE LEE | 56119 | 1234 | 97 |
| LIAHONA | 59798 | 3789 | 56 |
| LILLI ANN | 63484 | 4569 | 141 |
| LINDY | 20105 | 357 | 77 |
| LINNEA | 55741 | 4207 | 58 |
| LISA JEAN | 40129 | 3560 | 58 |
| LISA MELINDA | 41520 | 4506 | 81 |
| LITTLE SIOUX | 45345 | 2410 | 48 |
| LOKI | 36347 | 4323 | 48 |
| LONESTAR | 30332 | 213 | 86 |
| LORELAI BELL | 28665 | 2773 | 54 |
| LORELEI II | 18906 | 1257 | 56 |
| LUCK PT | 20319 | 318 | 41 |
| LUCKY ISLAND | 3800 | 2691 | 58 |
| LUCKY STAR | 1823 | 25349 | 49 |
| LUCY O | 77044 | 32957 | 57 |
| LYNX | 35771 | 2967 | 46 |
| MACUSHLA | 42838 | 26175 | 42 |
| MADRE DOLOROSA | 1835 | 23509 | 49 |
| MAGIA | 14796 | 2226 | 52 |
| MAGNUM | 75448 | 31083 | 48 |
| MAGNUS MARTENS | 77144 | 33091 | 58 |
| MAJESTIK | 74772 | 30166 | 74 |
| MAJESTY | 60650 | 3996 | 99 |

| Vessel Name | ADFG # | NMFS permit # | Length |
|-------------------|--------|---------------|--------|
| MAJOR | 1837 | 1502 | 57 |
| MAR DEL NORTE | 21650 | 435 | 92 |
| MAR PACIFICO | 23131 | 1674 | 96 |
| MARATHON | 36226 | 3483 | 58 |
| MARATHON | 49617 | 1191 | 87 |
| MARAUDER | 62288 | 4521 | 58 |
| MARCY J | 55 | 2142 | 97 |
| MARGARET LYN | 31672 | 723 | 123 |
| MARILYN J | 58282 | 3499 | 58 |
| MARK I | 6440 | 1242 | 99 |
| MARSONS | 76567 | 32413 | 55 |
| MARTIN | 28266 | 612 | 59 |
| MARY J | 40217 | 1863 | 100 |
| MASONIC | 33468 | 1279 | 70 |
| MAVERICK | 45706 | 4577 | 92 |
| MAYA T | 76388 | 32295 | 53 |
| MAYHEM II | 59920 | 19563 | 42 |
| MELANIE | 20363 | 1934 | 102 |
| MELISSA RAE | 67610 | 6004 | 56 |
| MEMORIES | 53486 | 2264 | 65 |
| MESSIAH | 66196 | 6081 | 83 |
| MICHELLE RENEE | 61244 | 4131 | 112 |
| MIDDLETON | 18603 | 5029 | 56 |
| MIKADO | 43384 | 3106 | 58 |
| MINDALINA | 37908 | 3076 | 44 |
| MINION | 57833 | 3826 | 42 |
| MINKE | 21390 | 2305 | 42 |
| MIRAGE | 65189 | 24231 | 50 |
| MISLEAD | 76451 | 32298 | 48 |
| MISS BERDIE | 59123 | 3679 | 87 |
| MISS BRENDA | 41421 | 4633 | 58 |
| MISS COURTNEY KIM | 76676 | 25218 | 58 |
| MISS KRISTIE | 42612 | 23724 | 43 |
| MISS LEONA | 25227 | 1482 | 86 |
| MISS LINDA | 17495 | 507 | 68 |
| MISS ROXANNE | 53446 | 1760 | 53 |
| MISS ROXANNE | 62777 | 4667 | 58 |
| MISS SARAH | 64109 | 4989 | 103 |
| MISS SONJA | 61673 | 4788 | 43 |
| MISS SUSAN | 23303 | 1523 | 54 |
| MITHRIL | 41588 | 25303 | 39 |
| MOJO | 43873 | 729 | 56 |

| Vessel Name | ADFG # | NMFS permit # | Length |
|----------------|--------|---------------|--------|
| MONARCH | 31588 | 2424 | 46 |
| MONIQUE | 74775 | 30177 | 40 |
| MOODY BLUE | 58174 | 15670 | 48 |
| MOONLIGHT | 14323 | 389 | 45 |
| MORGAN ANNE | 60857 | 4147 | 54 |
| MORGAN GRACE | 61215 | 4865 | 48 |
| MS INGRID | 25187 | 2204 | 58 |
| MS SAM | 62428 | 4626 | 52 |
| MU RUSH | 59740 | 4937 | 42 |
| MUIR MILACH | 41021 | 480 | 102 |
| MY OAR | 64430 | 5143 | 56 |
| MYRA | 36371 | 2583 | 54 |
| MYRIAD | 30017 | 26140 | 47 |
| MYSTERY | 75056 | 30512 | 52 |
| MYSTERY MAID | 19258 | 3072 | 56 |
| MYTHOS | 24950 | 2683 | 44 |
| NAKWASINA | 59703 | 11358 | 45 |
| NATURE | 71852 | 6394 | 43 |
| NAUTILUS | 61671 | 4220 | 50 |
| NAVIGATOR | 62996 | 4777 | 52 |
| NEDESDA | 70745 | 22516 | 40 |
| NEKTON | 37661 | 1010 | 54 |
| NEPHI | 32378 | 22691 | 47 |
| NEPTUNE | 38988 | 2258 | 56 |
| NETO | 46091 | 4251 | 41 |
| NETTED DREAMS | 77764 | 33945 | 49 |
| NEW DAWN | 21900 | 10733 | 48 |
| NEW LIFE | 21845 | 6182 | 79 |
| NEW VENTURE | 4 | 1137 | 100 |
| NEW VENTURE | 29116 | 28747 | 52 |
| NICHOLE | 60056 | 4037 | 78 |
| NICKELODEON | 62698 | 4776 | 59 |
| NIGHTRIDER | 63350 | 20284 | 46 |
| NIKKA | 10385 | 1148 | 42 |
| NIPNTUCK | 39006 | 2340 | 66 |
| NITE LITE | 60225 | 4265 | 44 |
| NOELANI | 77770 | 33952 | 42 |
| NORCOASTER | 38137 | 181 | 59 |
| NORDIC FURY | 200 | 1094 | 110 |
| NORDIC LADY | 14 | 1695 | 94 |
| NORDIC MARINER | 222 | 6191 | 120 |
| NORDIC STAR | 961 | 428 | 123 |

| Vessel Name | ADFG # | NMFS permit # | Length |
|----------------------|--------|---------------|--------|
| NORDIKA | 78053 | 19091 | 50 |
| NORFJORD | 59738 | 3775 | 51 |
| NORSE MAID | 42069 | 2926 | 58 |
| NORSEMEN | 41054 | 11531 | 42 |
| NORTH CAPE | 7939 | 748 | 58 |
| NORTH LIGHT | 39912 | 1837 | 47 |
| NORTH POINT | 53800 | 5389 | 85 |
| NORTH STAR - CP | 78507 | 34732 | 261 |
| NORTH STAR - CV | 18463 | 17125 | 56 |
| NORTHERN DEFENDER | 38431 | 208 | 148 |
| NORTHERN DREAM | 31428 | 1783 | 57 |
| NORTHERN EAGLE | 56618 | 3261 | 341 |
| NORTHERN ENDURANCE | 74791 | 30102 | 78 |
| NORTHERN FURY | 22949 | 571 | 52 |
| NORTHERN GLACIER | 48075 | 661 | 201 |
| NORTHERN HAWK | 60795 | 4063 | 341 |
| NORTHERN JAEGER - CV | 37316 | 818 | 58 |
| NORTHERN JAEGER - CP | 60202 | 3896 | 336 |
| NORTHERN LEADER | 77393 | 33320 | 184 |
| NORTHERN MARINER | 59607 | 3741 | 86 |
| NORTHERN PATRIOT | 55153 | 2769 | 165 |
| NORTHERN PRINCE | 61107 | 5912 | 60 |
| NORTHERN RAM | 62892 | 4611 | 85 |
| NORTHERN STAR | 47647 | 3233 | 53 |
| NORTHWEST EXPLORER | 36808 | 3002 | 162 |
| NOVA | 79168 | 35565 | 58 |
| NUKA POINT | 45513 | 5687 | 54 |
| NUSHAGAK SPIRIT | 54555 | 4151 | 110 |
| OBSESSION | 35553 | 1781 | 58 |
| OCEAN BAY | 68008 | 5908 | 58 |
| OCEAN CAPE | 67161 | 5663 | 52 |
| OCEAN CHALLENGER | 76092 | 31847 | 45 |
| OCEAN EXPLORER | 51073 | 3011 | 155 |
| OCEAN FURY | 97 | 5368 | 124 |
| OCEAN HARVESTER | 101 | 5130 | 108 |
| OCEAN HOPE 3 | 48173 | 1623 | 103 |
| OCEAN HUNTER | 40924 | 1964 | 99 |
| OCEAN INVICTUS | 30100 | 26728 | 76 |
| OCEAN LEADER | 32 | 1229 | 120 |
| OCEAN OASIS | 75145 | 30617 | 52 |
| OCEAN PEACE | 55767 | 2134 | 219 |
| OCEAN PROWLER | 43570 | 3336 | 155 |

| Vessel Name | ADFG # | NMFS permit # | Length |
|--------------------|--------|---------------|--------|
| OCEAN ROVER | 56987 | 3442 | 256 |
| OCEAN STORM | 64667 | 5000 | 58 |
| OCEANAIRE | 55937 | 3044 | 47 |
| ODIN | 63519 | 4634 | 58 |
| OLYMPIC | 48568 | 17103 | 54 |
| OPTIMUS | 77559 | 33588 | 58 |
| ORACLE | 77897 | 34110 | 57 |
| ORION | 31438 | 5743 | 41 |
| ORION | 50308 | 5048 | 53 |
| ORION | 73631 | 28837 | 48 |
| OUTLOOK | 35666 | 18381 | 52 |
| OUTLOOK | 55722 | 4417 | 42 |
| PACIFIC BOUNTY | 75678 | 31323 | 50 |
| PACIFIC CHALLENGER | 6931 | 657 | 116 |
| PACIFIC DAWN | 59497 | 5791 | 58 |
| PACIFIC EXPLORER | 50759 | 3010 | 155 |
| PACIFIC GOLD | 53321 | 4181 | 42 |
| PACIFIC KNIGHT | 59498 | 5807 | 58 |
| PACIFIC MAID | 17745 | 3627 | 58 |
| PACIFIC MARINER | 7 | 4581 | 126 |
| PACIFIC PRINCE | 61450 | 4194 | 149 |
| PACIFIC QUEST | 7011 | 1802 | 58 |
| PACIFIC RAM | 61792 | 4305 | 82 |
| PACIFIC SEA | 61056 | 4127 | 58 |
| PACIFIC SOJOURN | 48068 | 751 | 72 |
| PACIFIC SOUNDER | 991 | 427 | 98 |
| PACIFIC STAR | 29362 | 955 | 52 |
| PACIFIC STAR | 55038 | 2781 | 79 |
| PACIFIC STORM | 76731 | 32645 | 88 |
| PACIFIC SUN | 23638 | 2416 | 47 |
| PACIFIC SUN | 35977 | 3648 | 121 |
| PACIFIC SUN | 58060 | 4796 | 42 |
| PACIFIC VENTURE | 986 | 3238 | 103 |
| PACIFIC VIKING | 47 | 422 | 127 |
| PACIFIC WIND | 72642 | 27310 | 41 |
| PALOMNIK | 57766 | 3459 | 41 |
| PATRICIA ANN | 9297 | 3764 | 58 |
| PATRICIA L | 37036 | 1164 | 117 |
| PATRIOT | 44010 | 1896 | 58 |
| PAVLOF | 37374 | 3406 | 166 |
| PEGASUS | 57149 | 1265 | 96 |
| PEGGY JO | 9200 | 979 | 99 |

| Vessel Name | ADFG # | NMFS permit # | Length |
|----------------|--------|---------------|--------|
| PELICAN | 17437 | 1932 | 57 |
| PEREGRINE | 40282 | 1561 | 52 |
| PERSEVERANCE | 12668 | 2837 | 87 |
| PERSEVERANCE | 39513 | 2836 | 58 |
| PERSISTENCE | 78116 | 34245 | 55 |
| PHOENIX | 45612 | 6324 | 50 |
| PHOENIX | 56991 | 3357 | 276 |
| PHYLLIS ANN | 71429 | 7090 | 50 |
| PILLAR BAY | 26018 | 6399 | 58 |
| PILOT | 56459 | 3830 | 42 |
| PIONEER | 54888 | 12947 | 48 |
| PIONEER | 56740 | 4331 | 42 |
| POINT COUNTESS | 43343 | 17569 | 45 |
| POINT OMEGA | 12121 | 1937 | 72 |
| POLAR SEA | 303 | 4590 | 104 |
| POLAR STAR | 40 | 2512 | 58 |
| POLARIS | 19266 | 51 | 76 |
| PREDATOR | 33133 | 2844 | 59 |
| PREDATOR | 33744 | 1275 | 90 |
| PRIMUS | 61518 | 4226 | 58 |
| PRIVET | 27724 | 1773 | 42 |
| PROGRESS | 6 | 512 | 114 |
| PROVIDENCE | 38312 | 1085 | 44 |
| PROVIDENCE | 45211 | 3821 | 58 |
| PROVIDENCE | 52119 | 2420 | 70 |
| PROVIDER | 21465 | 4350 | 51 |
| PROVIDER | 35785 | 90 | 48 |
| PROWLER | 40920 | 1622 | 124 |
| QUEST | 36997 | 438 | 63 |
| QUICKSILVER | 56106 | 3037 | 41 |
| RAMBLIN ROSE | 59686 | 7158 | 103 |
| RASTLOS | 56951 | 5783 | 42 |
| RAVEN | 40252 | 2782 | 57 |
| RAVEN | 56395 | 1236 | 92 |
| RAVEN BAY | 47511 | 22938 | 56 |
| REBECCA IRENE | 51873 | 1610 | 140 |
| REBEL | 57475 | 5799 | 51 |
| REBEL ISLE | 76336 | 32261 | 58 |
| REDEMPTION | 76319 | 32214 | 58 |
| REDLINE | 21881 | 14827 | 42 |
| REDOUBT | 55759 | 4700 | 40 |
| REIVER | 62343 | 4304 | 58 |

| Vessel Name | ADFG # | NMFS permit # | Length |
|----------------|--------|---------------|--------|
| RELENTLESS | 19495 | 12164 | 49 |
| RENEGADE | 62327 | 6121 | 43 |
| RENEGADE | 63489 | 4833 | 47 |
| REPUBLIC | 19048 | 221 | 86 |
| RESOLUTE | 17402 | 46 | 72 |
| RESOLUTION | 56188 | 4719 | 40 |
| RESURRECTION | 45469 | 4468 | 49 |
| RIPTIDE | 53345 | 3489 | 41 |
| RISING SON | 77681 | 33748 | 51 |
| ROBERT MAGNUS | 76355 | 32228 | 58 |
| ROCINANTE | 36660 | 1984 | 47 |
| ROCKY B | 48348 | 1042 | 66 |
| ROSE LEE | 57985 | 3737 | 58 |
| ROSE LYNN | 23214 | 75 | 48 |
| ROSELLA | 21732 | 2861 | 90 |
| ROSIE M | 43426 | 5733 | 50 |
| ROULETTE | 60141 | 4452 | 42 |
| ROYAL AMERICAN | 40840 | 543 | 105 |
| ROYAL ATLANTIC | 46 | 236 | 124 |
| RUFF & REDDY | 53 | 651 | 90 |
| RUNAWAY | 57800 | 4768 | 42 |
| RUSAK | 53249 | 2049 | 41 |
| RUSTLER | 57777 | 3843 | 39 |
| SABRINA | 44862 | 11237 | 58 |
| SABRINA JOY | 61456 | 4824 | 46 |
| SAGA | 11022 | 5792 | 107 |
| SAGA | 19369 | 2284 | 57 |
| SAINT PAUL | 75473 | 31074 | 58 |
| SAINT PETER | 76769 | 32665 | 58 |
| SAN JUAN | 40132 | 4915 | 44 |
| SANDRA FIVE | 70770 | 10671 | 113 |
| SANDRA JO | 45962 | 1766 | 47 |
| SARA B | 19502 | 5882 | 58 |
| SARA DAWN | 54766 | 4896 | 58 |
| SAVANNA RAY | 40918 | 5001 | 98 |
| SCANDIA | 63644 | 4802 | 58 |
| SCANDIES ROSE | 35318 | 5456 | 130 |
| SCOTCH CAP | 69625 | 6134 | 58 |
| SEA AIRA | 66201 | 29829 | 44 |
| SEA ANGEL | 39289 | 341 | 47 |
| SEA BARB | 21609 | 232 | 58 |
| SEA DAWN | 55609 | 2239 | 42 |

| Vessel Name | ADFG # | NMFS permit # | Length |
|--------------------|--------|---------------|--------|
| SEA DREAM | 45140 | 4070 | 58 |
| SEA KING | 42079 | 2188 | 56 |
| SEA MAC | 6151 | 1043 | 87 |
| SEA STORM | 40969 | 420 | 123 |
| SEA VALLEY II | 43280 | 2853 | 66 |
| SEA VENTURE | 8225 | 2122 | 104 |
| SEA VIEW | 60168 | 6242 | 54 |
| SEA WOLF | 35957 | 1652 | 125 |
| SEABORN | 77773 | 33966 | 57 |
| SEABROOKE | 36800 | 3035 | 109 |
| SEADAWN | 77 | 2059 | 124 |
| SEAFISHER | 56964 | 3835 | 230 |
| SEAFORTH | 23331 | 16816 | 46 |
| SEAFREEZE ALASKA | 39798 | 2733 | 295 |
| SEAFREEZE AMERICA | 78120 | 34249 | 208 |
| SEAHUNTER II | 20044 | 22509 | 42 |
| SEAMOO | 24258 | 5467 | 41 |
| SEANNA | 18662 | 2897 | 47 |
| SEATTLE ENTERPRISE | 56789 | 3245 | 270 |
| SEBRIKA | 27699 | 1367 | 47 |
| SEDNA | 36041 | 5881 | 47 |
| SEEKER | 59476 | 2849 | 98 |
| SEENA | 63090 | 4854 | 42 |
| SENTENIL | 78511 | 34736 | 43 |
| SEQUOIA | 19874 | 2491 | 56 |
| SERENITY | 77765 | 33947 | 49 |
| SEYMOUR | 17530 | 283 | 82 |
| SHACKLETON | 36423 | 20461 | 51 |
| SHANNON D | 61467 | 10417 | 45 |
| SHANNON HOPE | 54953 | 18667 | 45 |
| SHAREENA | 33046 | 4229 | 52 |
| SHARI ANN | 60299 | 4180 | 54 |
| SHARON DAWN | 39351 | 5729 | 40 |
| SHAWNA RAE | 61119 | 4144 | 58 |
| SHEMYA | 29478 | 26034 | 58 |
| SHERRIE MARIE | 50842 | 3541 | 61 |
| SHINAKU | 26246 | 849 | 40 |
| SHONNA JACOLE | 36134 | 12468 | 50 |
| SHUYAK | 70135 | 6154 | 58 |
| SIBERIAN SEA | 62424 | 4578 | 136 |
| SIERRA MAR | 61802 | 4315 | 58 |
| SILVER LADY | 13108 | 554 | 56 |

| Vessel Name | ADFG # | NMFS permit # | Length |
|-----------------|--------|---------------|--------|
| SILVER STORM | 62001 | 4489 | 58 |
| SILVERSWORD | 60179 | 4445 | 58 |
| SILVERTIP | 17838 | 1334 | 52 |
| SILVERTIP | 56127 | 10963 | 46 |
| SINAI | 58227 | 5242 | 41 |
| SIREN | 19245 | 5062 | 58 |
| SISU | 59664 | 3711 | 58 |
| SONDER | 77644 | 33708 | 58 |
| SOULMATE | 62031 | 13285 | 48 |
| SOUTHEAST | 53163 | 1798 | 66 |
| SOUTHEASTERN | 46362 | 4383 | 52 |
| SOUTHERN SEAS | 61864 | 4333 | 66 |
| SOVEREIGN GRACE | 77623 | 33680 | 58 |
| SOVEREIGNTY | 55199 | 2770 | 165 |
| SPARTAN | 39602 | 19655 | 58 |
| SPECTRE | 21040 | 18583 | 58 |
| SPECTRUM | 38313 | 403 | 44 |
| SPICY LADY | 63252 | 4804 | 58 |
| SPLITFIRE | 61273 | 14467 | 44 |
| ST DOMINICK | 13437 | 146 | 58 |
| ST JILBE | 46371 | 2798 | 45 |
| ST JOHN II | 17406 | 485 | 65 |
| ST LORETTA | 33100 | 3903 | 48 |
| ST NICHOLAS | 45399 | 4882 | 58 |
| ST TERESA | 41419 | 29436 | 58 |
| STANLEY K | 75745 | 31423 | 58 |
| STAR FISH | 12 | 1167 | 124 |
| STARBOUND | 57621 | 3414 | 300 |
| STARLITE | 34931 | 1998 | 123 |
| STARWARD | 39197 | 417 | 123 |
| STAVANGER LADY | 58133 | 3583 | 77 |
| STELLA | 71208 | 7079 | 58 |
| STORM PETREL | 39860 | 1641 | 123 |
| STORMBRINGER | 31490 | 2376 | 56 |
| STRANGER | 60037 | 4867 | 44 |
| SUGAR | 28554 | 11297 | 41 |
| SULINA | 38415 | 2100 | 48 |
| SUMMER BAY | 41715 | 5474 | 113 |
| SUMMER BREEZE | 40761 | 12588 | 42 |
| SUMNER STRAIT | 23258 | 3297 | 58 |
| SUNDANCER | 62597 | 4659 | 64 |
| SUNRISE | 37123 | 2346 | 52 |

| Vessel Name | ADFG # | NMFS permit # | Length |
|---------------|--------|---------------|--------|
| SUNSET BAY | 35527 | 251 | 122 |
| SUNWARD | 14305 | 2075 | 65 |
| SUSAN | 12549 | 12017 | 54 |
| SUSAN KAY | 54846 | 4925 | 42 |
| SWAN | 18359 | 3771 | 49 |
| SWEETWATER | 59730 | 5506 | 40 |
| SWORD | 3467 | 634 | 41 |
| SYLVIA | 672 | 1309 | 44 |
| SYLVIA STAR | 61689 | 4211 | 58 |
| SYMPHONY | 18755 | 11023 | 49 |
| TAASINGE | 38001 | 912 | 75 |
| TALIA | 62580 | 4678 | 58 |
| TALON | 31586 | 1567 | 46 |
| TAMARACK | 31809 | 1741 | 50 |
| TAMMY LIN | 66275 | 5510 | 50 |
| TANA C | 32374 | 4340 | 56 |
| TANUSHA | 29606 | 26036 | 58 |
| TARYN ROSE | 79130 | 35497 | 57 |
| TAURUS | 49747 | 17058 | 58 |
| TEASHA | 11739 | 1649 | 48 |
| TEMPEST | 60434 | 4819 | 45 |
| TEMPTATION | 61395 | 4187 | 58 |
| TERN | 17076 | 1846 | 58 |
| TONI MARIE | 41360 | 1152 | 58 |
| TONSINA | 11996 | 4225 | 72 |
| TOPAZ | 40250 | 405 | 86 |
| TORNADO | 78814 | 35237 | 48 |
| TOWEGO | 49322 | 3451 | 58 |
| TRADITION | 61331 | 4316 | 58 |
| TRAIL BLAZER | 33704 | 3343 | 134 |
| TRANSIT | 55820 | 2713 | 44 |
| TRAVELER | 58821 | 3404 | 109 |
| TRIANNA | 79026 | 35321 | 60 |
| TRIBUTE | 42074 | 2576 | 58 |
| TRINITY | 6485 | 2829 | 58 |
| TRINKET | 40118 | 2499 | 52 |
| TRUMPETER | 29407 | 24436 | 57 |
| TSIU | 40961 | 1697 | 58 |
| TURNING POINT | 58601 | 4424 | 50 |
| TWO BEARS | 62995 | 4795 | 43 |
| U S LIBERATOR | 8522 | 372 | 162 |
| UNIMAK | 57211 | 3369 | 185 |

| Vessel Name | ADFG # | NMFS permit # | Length |
|-----------------|--------|---------------|--------|
| URSA MAJOR | 56993 | 3865 | 58 |
| US INTREPID | 54392 | 2800 | 185 |
| VAERDAL | 1119 | 2123 | 124 |
| VAGABOND QUEEN | 17948 | 1818 | 58 |
| VALHALLA | 67095 | 6104 | 44 |
| VALIANT | 996 | 5717 | 111 |
| VALLE LEE | 31361 | 1579 | 46 |
| VALOR | 64308 | 5043 | 48 |
| VANGUARD | 39946 | 519 | 94 |
| VANSEE | 19307 | 61 | 87 |
| VENUS | 10739 | 4155 | 48 |
| VICTORY | 77084 | 33004 | 112 |
| VIEKODA BAY | 57971 | 4593 | 100 |
| VIGILANT | 77747 | 33932 | 58 |
| VIGOROUS | 8357 | 937 | 67 |
| VIKING | 8 | 1222 | 144 |
| VIKING | 7177 | 11780 | 42 |
| VIKING EXPLORER | 36045 | 1116 | 124 |
| VIKING MAID | 41022 | 3861 | 58 |
| VIKING STAR | 32373 | 1938 | 58 |
| VINDICATOR | 28393 | 266 | 45 |
| VIS | 61593 | 4281 | 58 |
| VIXEN | 70030 | 6210 | 98 |
| VOLGA | 22708 | 2149 | 40 |
| VOYAGER | 16820 | 5540 | 46 |
| VOYAGER | 53032 | 20484 | 75 |
| VOYAGER | 58782 | 5873 | 42 |
| WAHOO | 75458 | 31040 | 56 |
| WALTER N | 34919 | 825 | 99 |
| WAVEDANCER | 38606 | 3823 | 52 |
| WENDY ANNE | 59483 | 4137 | 45 |
| WEST BANK | 30860 | 2975 | 47 |
| WESTERLY | 51935 | 16856 | 90 |
| WESTERN DAWN | 22294 | 134 | 113 |
| WESTERN FREEDOM | 74771 | 30196 | 58 |
| WESTERN MARINER | 963 | 1445 | 115 |
| WESTERN QUEEN | 10635 | 3718 | 58 |
| WESTERN VENTURE | 35632 | 1107 | 59 |
| WESTWARD I | 53247 | 1650 | 135 |
| WHISPER | 53259 | 3102 | 45 |
| WHITETAIL | 58043 | 18864 | 43 |
| WILLIAM | 1016 | 11277 | 54 |

| Vessel Name | ADFG # | NMFS permit # | Length |
|---------------|--------|---------------|--------|
| WILMA MAE | 34917 | 6278 | 44 |
| WIND FALL | 58248 | 21125 | 44 |
| WIND WALKER | 45454 | 1655 | 50 |
| WINTER BAY | 78286 | 34450 | 58 |
| WONDER WORKER | 36487 | 2119 | 48 |
| WONIYA | 53432 | 1979 | 72 |
| WOOSTER | 62131 | 14425 | 55 |
| X CALIBUR | 41541 | 3280 | 44 |
| YANKEE | 18223 | 2250 | 42 |
| YORJIM | 39149 | 5811 | 42 |
| ZEUS | 59028 | 13127 | 44 |
| ZONE FIVE | 61718 | 5391 | 105 |

****If you do not see a NMFS permit number or ADFG number on this list, look in the vessel logbook, contact NMFS staff, or talk to the vessel operator. The ADFG can always be found displayed on the side of the vessel.****

APPENDIX M: NMFS REPORTING AREAS FOR THE BERING SEA AND ALEUTIAN ISLANDS

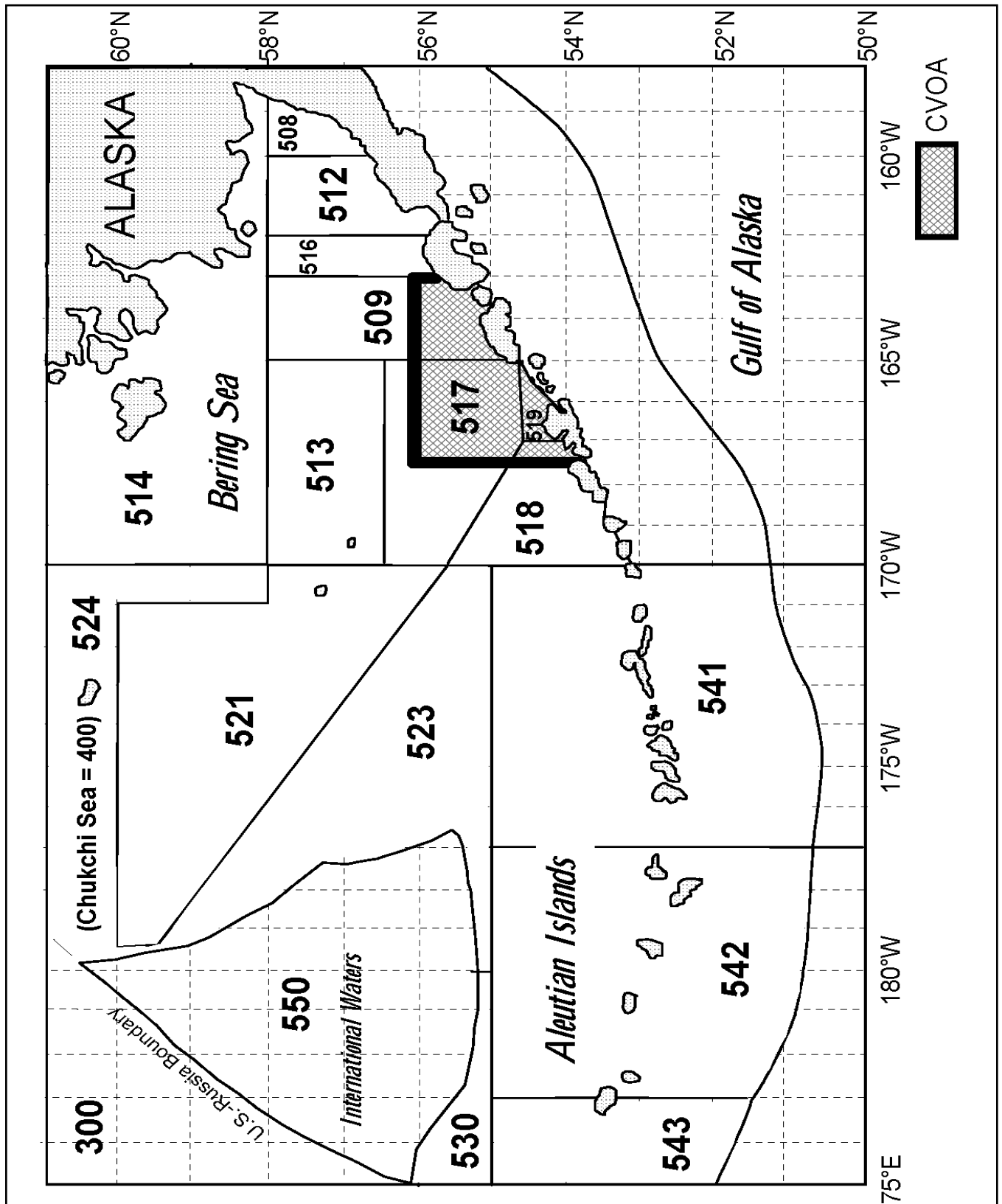

APPENDIX N: NMFS REPORTING AREAS FOR THE GULF OF ALASKA

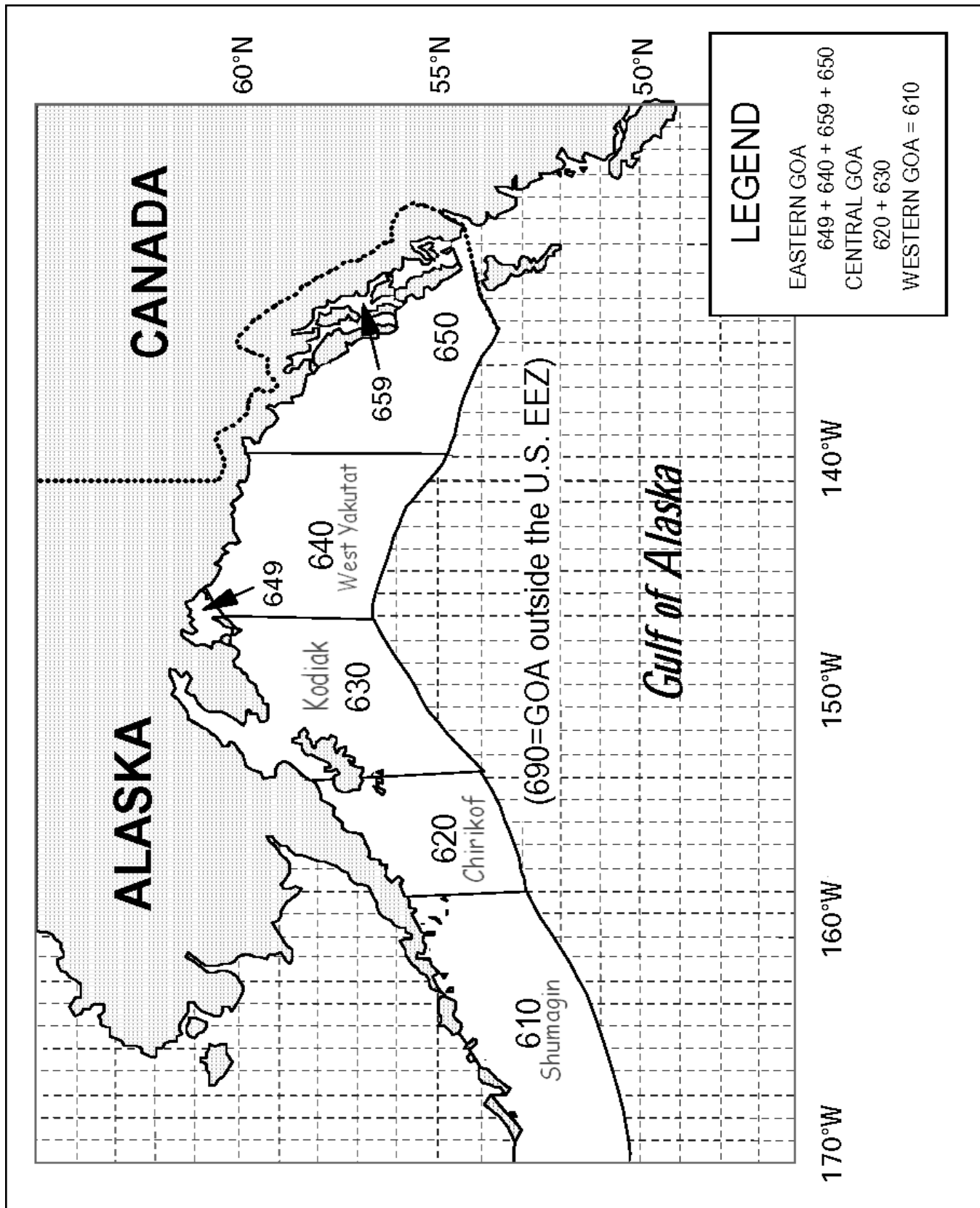

APPENDIX O. DECIMAL MINUTES TO SECONDS CONVERSION CHART

| Conversion Chart for Decimal Minutes* to Seconds | | | | | |
|--|------------------|-----------------|------------------|-----------------|------------------|
| * Decimal minutes and hundredths of minutes are the same thing | | | | | |
| ** If your vessel is recording decimal minutes to the thousandth place or greater, follow normal rounding rules to convert to the hundredth place. | | | | | |
| Decimal Minutes | Value in Seconds | Decimal Minutes | Value in Seconds | Decimal Minutes | Value in Seconds |
| 0.01 | 01 | 0.34 | 20 | 0.67 | 40 |
| 0.02 | 01 | 0.35 | 21 | 0.68 | 41 |
| 0.03 | 02 | 0.36 | 22 | 0.69 | 41 |
| 0.04 | 02 | 0.37 | 22 | 0.70 | 42 |
| 0.05 | 03 | 0.38 | 23 | 0.71 | 43 |
| 0.06 | 04 | 0.39 | 23 | 0.72 | 43 |
| 0.07 | 04 | 0.40 | 24 | 0.73 | 44 |
| 0.08 | 05 | 0.41 | 25 | 0.74 | 44 |
| 0.09 | 05 | 0.42 | 25 | 0.75 | 45 |
| 0.10 | 06 | 0.43 | 26 | 0.76 | 46 |
| 0.11 | 07 | 0.44 | 26 | 0.77 | 46 |
| 0.12 | 07 | 0.45 | 27 | 0.78 | 47 |
| 0.13 | 08 | 0.46 | 28 | 0.79 | 47 |
| 0.14 | 08 | 0.47 | 28 | 0.80 | 48 |
| 0.15 | 09 | 0.48 | 29 | 0.81 | 49 |
| 0.16 | 10 | 0.49 | 29 | 0.82 | 49 |
| 0.17 | 10 | 0.50 | 30 | 0.83 | 50 |
| 0.18 | 11 | 0.51 | 31 | 0.84 | 50 |
| 0.19 | 11 | 0.52 | 31 | 0.85 | 51 |
| 0.20 | 12 | 0.53 | 32 | 0.86 | 52 |
| 0.21 | 13 | 0.54 | 32 | 0.87 | 52 |
| 0.22 | 13 | 0.55 | 33 | 0.88 | 53 |
| 0.23 | 14 | 0.56 | 34 | 0.89 | 53 |
| 0.24 | 14 | 0.57 | 34 | 0.90 | 54 |
| 0.25 | 15 | 0.58 | 35 | 0.91 | 55 |
| 0.26 | 16 | 0.59 | 35 | 0.92 | 55 |
| 0.27 | 16 | 0.60 | 36 | 0.93 | 56 |
| 0.28 | 17 | 0.61 | 37 | 0.94 | 56 |
| 0.29 | 17 | 0.62 | 37 | 0.95 | 57 |
| 0.30 | 18 | 0.63 | 38 | 0.96 | 58 |
| 0.31 | 19 | 0.64 | 38 | 0.97 | 58 |
| 0.32 | 19 | 0.65 | 39 | 0.98 | 59 |
| 0.33 | 20 | 0.66 | 40 | 0.99 | 59 |

This page intentionally left blank

APPENDIX P. SHARK LENGTH TO WEIGHT TABLES

Length-Weight Table for Salmon Sharks (*Lamna ditropis*)

This table lists total natural length*

NOT TO BE USED WITH ESTIMATED LENGTHS

| Length (cm) | Weight (kg) | Length (cm) | Weight (kg) | Length (cm) | Weight (kg) |
|----------------|----------------|----------------|----------------|----------------|----------------|
| 161 | 48.96 | 194 | 88.02 | 227 | 143.23 |
| 162 | 49.93 | 195 | 89.44 | 228 | 145.19 |
| 163 | 50.91 | 196 | 90.88 | 229 | 147.16 |
| 164 | 51.91 | 197 | 92.33 | 230 | 149.14 |
| 165 | 52.92 | 198 | 93.80 | 231 | 151.15 |
| 166 | 53.94 | 199 | 95.28 | 232 | 153.17 |
| 167 | 54.98 | 200 | 96.78 | 233 | 155.21 |
| 168 | 56.03 | 201 | 98.29 | 234 | 157.27 |
| 169 | 57.09 | 202 | 99.82 | 235 | 159.34 |
| 170 | 58.16 | 203 | 101.36 | 236 | 161.44 |
| 171 | 59.25 | 204 | 102.92 | 237 | 163.55 |
| 172 | 60.35 | 205 | 104.50 | 238 | 165.68 |
| 173 | 61.46 | 206 | 106.09 | 239 | 167.82 |
| 174 | 62.58 | 207 | 107.70 | 240 | 169.99 |
| 175 | 63.72 | 208 | 109.32 | 241 | 172.17 |
| 176 | 64.88 | 209 | 110.96 | 242 | 174.37 |
| 177 | 66.04 | 210 | 112.61 | 243 | 176.59 |
| 178 | 67.22 | 211 | 114.28 | 244 | 178.83 |
| 179 | 68.42 | 212 | 115.97 | 245 | 181.08 |
| 180 | 69.63 | 213 | 117.67 | 246 | 183.36 |
| 181 | 70.85 | 214 | 119.39 | 247 | 185.65 |
| 182 | 72.08 | 215 | 121.12 | 248 | 187.96 |
| 183 | 73.33 | 216 | 122.87 | 249 | 190.30 |
| 184 | 74.60 | 217 | 124.64 | 250 | 192.64 |
| 185 | 75.87 | 218 | 126.42 | 251 | 195.01 |
| 186 | 77.17 | 219 | 128.22 | 252 | 197.40 |
| 187 | 78.47 | 220 | 130.04 | 253 | 199.81 |
| 188 | 79.79 | 221 | 131.88 | 254 | 202.23 |
| 189 | 81.13 | 222 | 133.73 | 255 | 204.68 |
| 190 | 82.48 | 223 | 135.59 | 256 | 207.14 |
| 191 | 83.84 | 224 | 137.48 | 257 | 209.62 |
| 192 | 85.22 | 225 | 139.38 | 258 | 212.12 |
| 193 | 86.61 | 226 | 141.30 | 259 | 214.64 |

***Natural length:** Total length from tip of snout to posterior margin of the longest caudal-fin lobe (upper lobe) with the fin in its natural position.

Length-Weight Table for Sleeper Sharks (*Somniosus pacificus*)

This table lists total natural length

NOT TO BE USED WITH ESTIMATED LENGTHS

| Length (cm) | Weight (kg) | | Length (cm) | Weight (kg) |
|-------------|-------------|---|-------------|-------------|
| 98-102 | 8.93 | | 253-257 | 178.03 |
| 103-107 | 10.44 | | 258-262 | 189.43 |
| 108-112 | 12.11 | | 263-267 | 201.33 |
| 113-117 | 13.96 | | 268-272 | 213.72 |
| 118-122 | 15.99 | Use the weight associated with the appropriate length range | 273-277 | 226.64 |
| 123-127 | 18.22 | | 278-282 | 240.08 |
| 128-132 | 20.66 | | 283-287 | 254.05 |
| 133-137 | 23.31 | | 288-292 | 268.58 |
| 138-142 | 26.18 | | 293-297 | 283.67 |
| 143-147 | 29.29 | | 298-302 | 299.32 |
| 148-152 | 32.64 | | 303-307 | 315.57 |
| 153-157 | 36.25 | | 308-312 | 332.41 |
| 158-162 | 40.12 | | 313-317 | 349.85 |
| 163-167 | 44.27 | | 318-322 | 367.92 |
| 168-172 | 48.70 | | 323-327 | 386.61 |
| 173-177 | 53.43 | | 328-332 | 405.95 |
| 178-182 | 58.46 | | 333-337 | 425.94 |
| 183-187 | 63.82 | | 338-342 | 446.60 |
| 188-192 | 69.50 | | 343-347 | 467.94 |
| 193-197 | 75.51 | | 348-352 | 489.97 |
| 198-202 | 81.88 | | 353-357 | 512.70 |
| 203-207 | 88.61 | | 358-362 | 536.15 |
| 208-212 | 95.70 | | 363-367 | 560.32 |
| 213-217 | 103.18 | | 368-372 | 585.23 |
| 218-222 | 111.05 | | 373-377 | 610.89 |
| 223-227 | 119.32 | | 378-382 | 637.31 |
| 228-232 | 128.01 | | 383-387 | 664.51 |
| 233-237 | 137.12 | | 388-392 | 692.50 |
| 238-242 | 146.66 | | 393-397 | 721.28 |
| 243-247 | 156.66 | | 398-402 | 750.88 |
| 248-252 | 167.11 | | 403-407 | 781.30 |

APPENDIX Q. SKATE LENGTH TO WEIGHT TABLE

Length-Weight Table for Big Skates (*R. binoculata*) and Longnose Skates (*R. rhina*)

NOT TO BE USED WITH ESTIMATED LENGTHS

| Length (cm) | Weight (kg) | | Length (cm) | Weight (kg) | |
|-------------|----------------------|-----------------|-------------|----------------------|-----------------|
| | <i>R. binoculata</i> | <i>R. rhina</i> | | <i>R. binoculata</i> | <i>R. rhina</i> |
| 135 | 17.12 | 15.84 | 173 | 36.76 | 34.32 |
| 136 | 17.52 | 16.21 | 174 | 37.42 | 34.94 |
| 137 | 17.92 | 16.58 | 175 | 38.08 | 35.57 |
| 138 | 18.32 | 16.96 | 176 | 38.76 | 36.21 |
| 139 | 18.74 | 17.35 | 177 | 39.44 | 36.85 |
| 140 | 19.15 | 17.74 | 178 | 40.13 | 37.50 |
| 141 | 19.58 | 18.14 | 179 | 40.83 | 38.16 |
| 142 | 20.01 | 18.54 | 180 | 41.53 | 38.83 |
| 143 | 20.45 | 18.95 | 181 | 42.25 | 39.51 |
| 144 | 20.89 | 19.37 | 182 | 42.97 | 40.19 |
| 145 | 21.34 | 19.79 | 183 | 43.70 | 40.89 |
| 146 | 21.80 | 20.22 | 184 | 44.44 | 41.59 |
| 147 | 22.26 | 20.65 | 185 | 45.19 | 42.30 |
| 148 | 22.73 | 21.09 | 186 | 45.95 | 43.01 |
| 149 | 23.21 | 21.54 | 187 | 46.71 | 43.74 |
| 150 | 23.69 | 22.00 | 188 | 47.48 | 44.47 |
| 151 | 24.18 | 22.46 | 189 | 48.27 | 45.21 |
| 152 | 24.67 | 22.92 | 190 | 49.06 | 45.96 |
| 153 | 25.18 | 23.40 | 191 | 49.86 | 46.72 |
| 154 | 25.69 | 23.88 | 192 | 50.67 | 47.49 |
| 155 | 26.21 | 24.36 | 193 | 51.48 | 48.26 |
| 156 | 26.73 | 24.86 | 194 | 52.31 | 49.05 |
| 157 | 27.26 | 25.36 | 195 | 53.14 | 49.84 |
| 158 | 27.80 | 25.86 | 196 | 53.99 | 50.64 |
| 159 | 28.34 | 26.38 | 197 | 54.84 | 51.45 |
| 160 | 28.90 | 26.90 | 198 | 55.70 | 52.27 |
| 161 | 29.46 | 27.43 | 199 | 56.57 | 53.10 |
| 162 | 30.02 | 27.96 | 200 | 57.45 | 53.93 |
| 163 | 30.60 | 28.50 | 201 | 58.34 | 54.78 |
| 164 | 31.18 | 29.05 | 202 | 59.24 | 55.63 |
| 165 | 31.77 | 29.61 | 203 | 60.15 | 56.50 |
| 166 | 32.37 | 30.17 | 204 | 61.07 | 57.37 |
| 167 | 32.97 | 30.74 | 205 | 61.99 | 58.25 |
| 168 | 33.58 | 31.32 | 206 | 62.93 | 59.14 |
| 169 | 34.20 | 31.90 | 207 | 63.87 | 60.04 |
| 170 | 34.83 | 32.49 | 208 | 64.83 | 60.95 |
| 171 | 35.46 | 33.09 | 209 | 65.79 | 61.87 |
| 172 | 36.11 | 33.70 | 210 | 66.77 | 62.80 |

This page reserved for later use

APPENDIX R: HALIBUT CONDITION CRITERIA FOR TRAWL BYCATCH

The criteria are listed in order of importance.

Excellent: Fish is alive, showing no stress, and injuries, if any, are slight.

1. External injuries.
 - Superficial nicks or cuts on body.
 - Little (<10% of fin area) or no fraying of dorsal and anal fin.
 - Hemorrhaging (redness) of skin on white side limited to 5-10% of surface area.
2. Operculum pressure.
 - Fish is able to close operculum tightly for at least 5-10 seconds.
 - Muscle tone and physical activity.
 - Strong and lively, perhaps flopping around on deck if provoked.
 - Fish can tightly clench its jaw.
3. Bleeding.
 - No bleeding observed.
4. Gills and gill color.
 - Deep red in color.

Poor: Fish is alive, but showing signs of stress.

1. 1. Injuries are apparent.
 - Body abrasions have damaged the skin but skin is still present, not missing.
 - Cuts and lacerations in body extend through skin just into flesh and are not deep.
 - Between 10 and 50% of dorsal and anal fins are frayed.
 - Slight bleeding from fin edges.
 - Approximately 10-25% of skin on white side of fish shows hemorrhaging.
2. Operculum pressure.
 - Fish closes operculum weakly and not sustained.
3. •Muscle tone or physical activity.

- Weak, intermittent movement. May respond if stimulated or provoked.

- Body is limp, but not in rigor mortis.

4. Bleeding.

- Blood is continually flowing from gills, but not profusely.

5. Gills and gill color.

- Deep to bright red in color.

Dead: No sign of life or, if alive, likely to die from severe injuries or suffocation.

1. Injuries are apparent.

- Body cavity ripped open.

- Internal organs exposed and damaged.

- Cuts and lacerations in body extend deeply into the flesh.

- Sediment in mouth.

- Hemorrhaging in skin on 25% or more of white side.

2. Operculum pressure.

- Fish does not close operculum.

3. Muscle tone and physical activity.

- No sign of muscle tone (limp) or fish is in rigor (stiff).

- Physical activity absent or limited to fin ripples or twitches.

- Little, if any, response to stimuli.

- Jaw is hanging open.

4. Bleeding.

- Blood is flowing freely and continuously in large quantity from a torn or severed gill arch, or a body injury.

5. Gills and gill color.

- Gills appear washed out, e.g., dull red, pink, or white in color.

APPENDIX S: KEY TO PACIFIC HALIBUT VIABILITY FOR TRAWL VESSELS

Codes: Excellent = E, Poor = P, Dead = D, Unknown = U

- 1a. Fish is alive Go to 2a
- 1b. Fish is dead when sorted from the catch code **DEAD**
Fish is in rigor and lifeless, even if no apparent injuries. Gills appear washed out, i.e., dull red, pink, or white in color. Mouth may contain sediment.
- 2a. Body of fish appears uninjured, or has only minor injuries Go to 3a
- 2b. Injuries to fish are significant and obvious code **DEAD**
Body cavity is ripped open, exposing internal organs. Body tissue may be torn or ripped in a rough, ragged manner. Red hemorrhaging observed on 25% or more of the white side.
- 3a. Fish is able to close operculum when stimulated Go to 4a
Operculum is closed strongly or weakly, but pressure is evident. Operculum may not stay closed for long, though pressure may last up to 5 seconds or longer.
- 3b. Fish cannot close operculum, even when stimulated. code **DEAD**
- 4a. Fish displays activity and has muscle tone go to 5a
Fish displays a minimal amount of activity, especially when stimulated. May be able to clench jaw tightly.
- 4b. Fish exhibits no muscle tone code **DEAD**
- 5a. Fish is not bleeding, or only slightly bleeding, if at all. go to 6a
- 5b. Blood is flowing freely and continuously in large quantity (profusely) code **DEAD**
Bleeding is coming from a torn or severed gill arch, or a body injury.
- 6a. Body injuries are minimal, perhaps difficult to find. go to 7a
May consist of superficial nicks or cuts on body. Less than 10% of dorsal and anal fin area is frayed.
- 6b. Body injuries are readily apparent code **POOR**
Skin is damaged with abrasions. Cuts and lacerations in body extend through the skin and just barely into the flesh (not deeply). Dorsal and anal fin area is frayed between 10-50% Fin edges may be bleeding. Roughly 10-25% of the white side of fish shows red hemorrhaging.
- 7a. Operculum pressure is strong and sustained go to 8a
- 7b. Operculum pressure is weak and not sustained code **POOR**
- 8a. Fish is strong and lively, displaying good muscle tone. go to 9a
Fish is flopping around the deck, hard to control. Jaw may be tightly clenched, difficult to open.
- 8b. Fish appears weak code **POOR**
Movement is intermittent, perhaps occurring when provoked or stimulated. Body is limp.
- 9a. Fish is bleeding from gills code **POOR**
Blood is flowing continuously, slow and steadily, but not profusely. Gills are deep to bright red in color.
- 9b. No bleeding observed code **EXCELLENT**
Gills are deep red in color.

APPENDIX T: HALIBUT INJURY CRITERIA FOR LONGLINE BYCATCH

The criteria are listed in order of importance

Minor injuries: Injuries, if any, are slight and inconsequential to health of the fish.

1. Injuries around the mouth from the hook and hook removal are slight.
 - A hook entrance/exit hole around the jaw or in the cheek.
 - The lip (skin covering the external portion of the jaw) may be torn and hanging.
 - The hook and some length of residual ganglion may be hanging from the mouth if the ganglion was cut.
2. Very little bleeding, if any.
 - Bleeding is seen only in the area surrounding the jaw.
 - Bleeding may have stopped, or may be continuing very slowly a few drops at a time.
3. No penetration of the body or head by sand fleas.
 - Membranes surrounding eyes and anus are intact, without any holes from sand fleas.
 - A few sand fleas may be seen on body and can be wiped off with your hand. Typically, no penetration has occurred when only a few (e.g., <10) sand fleas are found on the body.

Moderate injuries: Injuries are present, but are not severe.

1. Injuries may have been inflicted to the jaw, cheek, eye, or body.
 - Lower jaw may be broken into 2 pieces at the snout, but each is still attached at the base of the jaw.
 - Jaw is torn on one side or the other, possibly extending through the cheek.
 - Hook may have punctured the eye or eye socket.
 - Wounds on head and abdomen limited to surface scratches on skin.
 - No wounds of any kind to abdominal organs.

Abdominal cavity wall not punctured.

- Wounds in body consist of puncture holes in skin, with possibly a flesh tear.
2. Bleeding is occurring but not from gills.
 - Blood may be seen around mouth and jaw.
 - Blood is not flowing profusely, but is oozing continuously.
 3. No penetration of the body or head by sand fleas.
 - Membranes surrounding eyes and anus are intact, without any holes from sand fleas.
 - A few sand fleas may be seen on body and can be wiped off with your hand. Typically, no penetration has occurred when only a few (e.g., <10) sand fleas are found on the body.

Severe injuries: Severe life-threatening injuries can be seen.

1. Injuries to the head and/or jaw have occurred. Any of the following will be present, individually or in combination:
 - Skin on head (forward of preopercle) is ripped and torn deeply, exposing tissue and internal organs.
 - Side of the head, possibly including the jaw, has been torn loose and missing from the fish.
 - Lower jaw has been torn away and is missing.
 - No wounds of any kind to abdominal organs. Abdominal cavity wall not punctured.
2. No penetration of the body or head by sand fleas.
 - Membranes surrounding eyes and anus are intact, without any holes from sand fleas.
 - A few sand fleas may be seen on body and can be wiped off with your hand. Typically, no penetration has occurred when only a few (e.g., <10) sand fleas are found on the body.

(Condition criteria continued on next page.)

Dead/Fleas/Bleeding: Fish is lifeless, sand flea predation, severe bleeding.

1. Fish is already dead when brought to the surface on the gear.
 - Fish is in rigor and lifeless, even if no apparent injuries.
 - Gills appear completely devoid of blood (light pink or white in color).
2. Marine mammals have taken bites out of the fish.
 - Usually taken out of the back of the fish or from the abdominal cavity.
3. Sand fleas have penetrated the body via the eyes, fins, or anus.
 - Membrane surrounding eye may be partially or completely missing.
 - Dorsal and/or anal fin membranes may be eaten away, leaving fin rays exposed. Skin on the body is separated from tissue where sand fleas have eaten.
4. Bleeding is severe, especially from the gills.
 - Blood is flowing freely and continuously in large quantity.
 - Bleeding is occurring from a torn or severed gill arch.
5. Internal organs are damaged, possibly by a gaff.
 - Abdominal cavity wall is punctured or torn.
 - Viscera are visible and exposed, and may be protruding.

APPENDIX U: KEY TO LONGLINE INJURY CODES FOR PACIFIC HALIBUT

Codes: 1 = Minor, 2 = Moderate, 3 = Severe, 4 = Dead/Sand Fleas/Bleeding, 9 = Unknown

- 1a. Fish is aliveGo to 2a
- 1b. Fish is dead when brought to the surface on the gear code **DEAD**
Fish is in rigor and lifeless, even if no apparent injuries. Gills appear completely devoid of blood (light pink or white in color).
- 2a. Body shows no signs of marine mammal depredationGo to 3a
Fish's body is intact. Flesh may be torn, but no missing tissue.
- 2b. Body is missing pieces of flesh code **DEAD**
Pieces of tissue are missing from depredation by marine mammals. Missing pieces are typical of bites from sea lions or other large marine mammals.
- 3a. No penetration of the body or head by sand fleasGo to 4a
Membranes surrounding eyes and anus are intact, without any holes from sand fleas. A few sand fleas may be seen on body and can be wiped off with your hand. Typically, no penetration occurs when only a few (e.g. <10) sand fleas are found on the body.
- 3b. Sand fleas have penetrated the body via the eyes, fins, or anus code **DEAD**
Membranes surrounding eye may be partially or completely missing. Dorsal and/or anal fin membranes may be eaten away, leaving fin rays exposed. Skin on the body is separated from tissue where sand fleas have eaten.
- 4a. No wounds of any kind to abdominal organs. Abdominal wall not punctured go to 5a
- 4b. Abdominal organs are damaged, possibly by a gaff code **DEAD**
Abdominal cavity wall is punctured or torn. Viscera are visible and exposed, and may be protruding.
- 5a. Fish is not bleeding from gills (but may be bleeding from elsewhere) go to 6a
- 5b. Fish is bleeding from gills code **DEAD**
Bleeding is occurring from a torn or severed gill arch.
- 6a. Fish is not bleeding at all, or bleeding is minor to moderate (not from gills) go to 7a
Blood may be seen around mouth and/or jaw. Blood may be oozing continuously, or bleeding may be continuing very slowly a few drops at a time, or bleeding may have stopped.
- 6b. Bleeding is severe code **DEAD**
Blood from any source is flowing freely and continuously in large quantity.
- 7a. Injuries to head and/or jaw are minor to moderate, but no structures are missing go to 8a
- 7b. Major injuries to head and jaw, resulting in missing pieces code **SEVERE**
Side of the head, possibly including the jaw, has been torn loose and missing from the fish, and/or lower jaw has been torn away and is missing.
- 8a. Wounds to the head (forward of preopercle and above cheek and jaw) are only surface scratches on the skin go to 9a
- 8b. Skin on head (forward of preopercle) is ripped and torn deeply code **SEVERE**
Internal organs are likely exposed.
- 9a. Eye or eye socket is not punctured go to 10a
- 9b. Eye or eye socket is punctured code **MODERATE**

(Key continues on next page)

10a. No wounds to the body are evident go to 11a

10b. Wounds in body consist of puncture holes in skin, with possibly a flesh tear code **MODERATE**

11a. Lower jaw is significantly damaged code **MODERATE**

Lower jaw may be broken into 2 pieces at the snout, but each is still attached at the base of the jaw. Jaw may be torn on one side or the other, possibly extending through the cheek.

11b. Damage to lower jaw, if any, is slight code **MINOR**

Injuries include the hook entrance/exit hole around the jaw or in the cheek, or a tear in the cheek. A piece of the lip may be torn and hanging from the jaw. If the gangion was cut, the hook and some length of residual gangion may be hanging from the mouth.

APPENDIX V. HALIBUT CONDITION CRITERIA FOR POT BYCATCH

The criteria are listed in order of importance

Excellent: Fish is alive, showing no stress, and injuries, if any, are slight.

1. External injuries.
 - Superficial nicks or cuts on body.
 - Little (<10% of fin area) or no fraying of dorsal and anal fins.
 - Hemorrhaging (redness) of skin on white side limited to 5-10% of surface area.
2. Operculum pressure.
 - Fish is able to close operculum tightly for at least 5-10 seconds.
3. Muscle tone and physical activity.
 - Strong and lively, perhaps flopping around on deck if stimulated.
 - Fish can tightly clench its jaw.
4. Bleeding.
 - No bleeding from gills, body, or fins observed.
5. Gills and gill color.
 - Deep red in color.
6. No penetration of the body or head by sand fleas. No predation by crabs.
 - Membranes surrounding eyes and anus are intact, without any holes from sand fleas.
 - A few sand fleas may be seen on body, but can be wiped off with your hand. Typically, no penetration has occurred when only a few (e.g., <10) sand fleas are found on the body.

Poor: Fish is alive, but displaying physical injuries and signs of stress.

1. External injuries are apparent.
 - Body abrasions have damaged the skin but skin is still present, not missing.

- Cuts and lacerations in body extend through skin just into flesh and are not deep.
 - Between 10 and 50% of dorsal and anal fins are frayed.
 - Slight bleeding from fin edges.
 - Approximately 10-25% of skin on white side of fish shows hemorrhaging.
2. Operculum pressure.
 - Fish closes operculum weakly and not sustained.
 3. Muscle tone or physical activity is weak.
 - Intermittent body movement. May respond if stimulated.
 - Body appears limp, but not in rigor mortis.
 4. Bleeding.
 - Blood is not flowing profusely, but is oozing continuously from fin edges or body wounds.
 5. Gills and gill color.
 - Gills are deep to bright red.
 6. No penetration of the body or head by sand fleas. No crab predation.
 - Membranes surrounding eyes and anus are intact, without any holes from sand fleas.
 - A few sand fleas may be seen on body, but can be wiped off with your hand. Typically, no penetration has occurred when only a few (e.g., <10) sand fleas are found on the body.
 - No damage to the fish from crabs, if any, in the pot.

Dead/Fleas: No sign of life or, if alive, likely to die from injuries or predation.

1. External and internal injuries.
 - Body cavity may be ripped open.
 - Internal organs may be exposed and damaged.

(Condition criteria continued on next page.)

- Body tissue may be torn or ripped in a rough, ragged manner.
 - Hemorrhaging in skin on 25% or more of white side.
2. Operculum pressure.
 - Fish does not close operculum.
 3. Muscle tone and physical activity.
 - No sign of muscle tone (limp) or fish is in rigor (stiff).
 - Physical activity absent or limited to fin ripples or twitches.
 - Little, if any, response to stimuli.
 - Jaw may be open and slack.
 4. Bleeding.
 - Blood is flowing profusely from fin edges or body.
 5. Gills and gill color.
 - Gills appear washed out, e.g., dull red, pink, or white in color.
 6. Sand fleas have penetrated the body via the eyes, fins, or anus. Crab predation may also occur.
 - Membrane surrounding eye may be partially or completely eaten by sand fleas.
 - Dorsal and/or anal fin membranes may be eaten away, leaving fin rays exposed. Skin on the body is separated from tissue where sand fleas have eaten.
 - Crabs in the pot may also have attacked and eaten the “dead” fish.

APPENDIX W: KEY TO POT CONDITION CODES FOR PACIFIC HALIBUT

Codes: Excellent = E, Poor = P, Dead = D, Unknown = U

- 1a. Fish is alive Go to 2a
- 1b. Fish is dead when sorted from the catch code **DEAD**
Fish is in rigor and lifeless, even if no apparent injuries. Gills appear washed out, i.e., dull red, pink, or white in color.
- 2a. No penetration of the body or head by sand fleas Go to 3a
Membranes surrounding eyes and anus are intact, without any holes from sand fleas. A few sand fleas may be seen on body and can be wiped off with your hand. Typically, no penetration has occurred when only a few (e.g. <10) sand fleas are found on the body.
- 2b. Sand fleas have penetrated the body via the eyes, fins, or anus code **DEAD**
Membrane surrounding eye may be partially or completely missing. Dorsal and/or anal fin membranes may be eaten away, leaving fin rays exposed. Skin on the body is separated from tissue where sand fleas have eaten.
- 3a. No predation of the fish's body by crabs in the pot is noted Go to 4a
- 3b. Predation by crabs has occurred code **DEAD**
Crabs in the pot may have attacked and eaten the fish.
- 4a. Body of fish appears uninjured, or has only minor injuries go to 5a
- 4b. Injuries to fish are obvious and significant code **DEAD**
Body cavity is ripped open, exposing internal organs. Body tissue may be torn or ripped in a rough, ragged manner. Red hemorrhaging observed on 25% or more of the white side.
- 5a. Fish is able to close operculum when stimulated go to 6a
*Operculum is closed strongly or weakly, but pressure is evident. Operculum may not stay closed for long, though pressure may last up to 5 seconds or longer. 5b. Fish cannot close operculum, even when stimulated code **DEAD***
- 6a. Fish displays activity and has muscle tone go to 7a
Fish displays a minimal amount of activity, especially when stimulated. May be able to clench jaw, perhaps tightly.
- 6b. Fish exhibits no muscle tone code **DEAD**
Physical activity absent or limited to fin ripples or twitches. Little, if any response to stimuli. Jaw is hanging open and is slack.
- 7a. Fish is not bleeding, or only slightly bleeding, if it all go to 8a
- 7b. Blood is flowing freely and continuously in a large quantity (profusely) code **DEAD**
Bleeding is coming from fin edges or a body injury.
- 8a. Body injuries are minimal, perhaps difficult to find. go to 9a
*May consist of superficial nicks or cuts on body. Less than 10% of dorsal and anal fin area is frayed. Hemorrhaging of skin on white side limited to < 10% of surface area. 8b. Body injuries are readily apparent code **POOR***
Skin is damaged with abrasions. Cuts and lacerations in body extend through the skin and just barely into the flesh (not deeply). Dorsal and anal fin area is frayed between 10-50%. Fin edges may be bleeding slightly. Roughly 10-25% of the white side of fish shows red hemorrhaging.
- 9a. Operculum pressure is strong and sustained go to 10a
Fish should be able to close operculum for at least 5-10 seconds.
- 9b. Operculum pressure is weak and not sustained code **POOR**

(Key continues on next page)

10a. Fish is strong and lively, displaying good muscle tone. go to 11a
Fish is flopping around the deck, hard to control. Jaw may be tightly clenched, difficult to open.

10b. Fish appears weak. code **POOR**
Movement is intermittent and of short duration, perhaps occurring when provoked or stimulated. Body appears limp, not in rigor mortis.

11a. Fish is bleeding from fin edges or body. code **POOR**
Blood is oozing continuously from fin edges or body wounds. Gills are deep to bright red in color.

11b. No bleeding observed code **EXCELLENT**
Gills are deep red in color. Fins are not bleeding.

APPENDIX X: CONTACT ADDRESSES AND NUMBERS

North Pacific Observer Program

During work hours, staff members will accept collect calls. After hours, voice mail accepting collect calls is available at (206) 526-4240. Leave a message, even if only to tell us you are trying to reach us.

Address

NMFS Observer Program,
7600 Sand Point Way NE
Seattle, WA 98115-0070

Data Receiving Lines:

Fax: (206) 526-4066

Staff Lines:

Training & Debriefing: (206) 526-4192
ATLAS software or communication questions:
(206) 526-4240, Glenn.Campbell@noaa.gov
Gear Room Bldg. 33: (206) 940-5564
Initial check in hotline (206) 526-4366

Anchorage Field Station

Address

Federal Building Annex
222 W. 8th Ave., Suite
A41 Anchorage, AK99513

Phone: (907) 271-1313

Fax: (907) 271-1315

Dutch Harbor Field Station

Physical Address

2315 Airport Beach Road, Suite 105
Dutch Harbor, AK 99692

Mailing Address

P.O. Box 920225
Dutch Harbor, AK 99692

Phone: (907) 581-2060

Fax: (907) 581-2066

VHF Channel 16: Monday - Friday 0900-1700

Kodiak Field Station

Address

NMFS Observer Program 301 Research Court
Kodiak, AK 99615

Phone: (907) 481-1770 or (907) 481-1772

Fax: (907) 481-1771

Alaska Regional Office

Address

National Marine Fisheries Service
P.O. Box 21668
Juneau, AK 99802-1668

Phone: (907) 586-7228 or Fax: (907)586-7465

This office will accept collect calls from observers on matters directly related to observer work. They will not answer "quota remaining" or "fishery closure" questions.

North Pacific Observer Program**Enforcement**

If you are the victim of a crime and you would like to report directly to law enforcement, you may contact a Special Agent or the Observer Program Liaison directly. The Special Agents are specifically trained to assist you:

Special Agent
Jaclyn Smith (Anchorage) Office:
(907) 271-1869
Cell: (907) 382-8452
Jaclyn.Smith@noaa.gov

Observer Program Liaison
Dennis Jaszka (Seattle)
Office: (206) 526-4316

If you are in one of these Alaska ports, you may also contact the local NOAA Fisheries Enforcement office:

Kodiak (907) 486-3298
Dutch Harbor (907) 581-2061
Seward (907) 224-5348
Homer (907) 235-2337
Sitka (907) 747-6940
Ketchikan (907) 247-5804
Petersburg (907) 772-2285
Juneau (907) 586-7225

To report a fishery or marine mammal violation, you may also contact the NOAA Fisheries Enforcement Hot Line 1-800-853 1964.

Victim advocacy organizations provide confidential support for victims of crimes including assault, sexual assault, workplace harassment, and rape. For 24 hour Advocate resources, call 1 888-99-VOICE (1-888-998-6423). Additional contact numbers for Advocacy and Help Resources are found on page 20-8.

International Pacific Halibut Commission (IPHC)

Phone: (206) 634-1838

U.S. Coast Guard

| | |
|---|--|
| Anchorage..... | Russ Hazlett @ (907) 428-4154 or Ed Miner @ (907) 428-4162 |
| Kodiak..... | Marine Safety Detachment @ (907) 486-5918 |
| Unalaska(DutchHarbor)..... | Marine Safety Detachment @ (907) 581-3466 |
| USCG Sector Anchorage | P.O. Box 5800 JBER, Anchorage, AK 99505 24-Hour: (907) 428-4100 FAX: (907) 428-4114 |
| USCG District 17 (Juneau) | Fishing Vessel Safety Coordinator @ (907) 463-2810 |
| USCG website Commercial Fishing Industry Vessel Safety | <i>FishSafeWest.info</i> |

APPENDIX Y: WORKPLACE VIOLENCE PREVENTION & RESPONSE



WORKPLACE VIOLENCE PREVENTION & RESPONSE

Understanding SASH

SA **Sexual assault** is a range of criminal behaviors that includes, but is not limited to: completed or attempted non-consensual sexual acts; rape or abusive sexual contact with sexual organs or erogenous zones; any sexual act or behavior where the other person does not or cannot give consent.

Note: NOAA workforce who experience and report SA have a restricted reporting option which may enable access to support services without triggering an investigation. Please contact WVPR for more information.

SH **Sexual harassment** includes unwelcome sexual advances; requests for sexual favors; physical conduct of a sexual nature that impacts employment or work performance; creating an intimidating, hostile, or offensive work environment.

Report a SASH incident, obtain advocacy services, learn about Restricted and Unrestricted reporting options for sexual assault and sexual harassment, or request more information through any of the following resources:



Reporting Email:

noaa.victimservices@noaa.gov



Reporting Website:

NOAASASHHelpline.org



WVPRO Internal Site

sites.google.com/noaa.gov/wvpr/home

NOAA SASH Helpline



Phone:

866-288-6558
option 1



Text:

202-335-0265

Scan QR code for
WVPRO Website



APPENDIX Z: RADIO INSTRUCTIONS

The radios that you will encounter most often are **VHF-FM** (Very High Frequency Modulation), used for short-range vessel-to-vessel and vessel-to-shore communication, and **HF-SSB** (High Frequency-Single Side Band), used for communication when the stations are out of VHF range with each other. Both types offer certain special advantages, and each requires a specific operating procedure.

VHF Radios

In the United States, the VHF band is broken up into 71 channels, with a frequency range of from 156.000 to 163.000 MHz, including six WX (Weather) channels. By law, all operating VHF stations are required to have at least three of these channels: channel 6, channel 16, and at least one other working channel.

Channel 6

(156.300 MHz) is the Intership Safety Channel, used for intership safety purposes, search-and rescue (SAR) communications with ships and radios aircraft of the U.S. Coast Guard, and vessel movement reporting within ports and inland waterways. This channel must not be used for non-safety communications.

Channel 16

(156.800 MHz) is the International Distress, Safety, and Calling Channel (Intership and Ship-to-Coast). This channel must be monitored at all times the station is in operation (except when actually communicating on another channel). This channel is also monitored by the U.S. Coast Guard, Public Coastal Stations, and many Limited Coastal Stations. Calls to vessels are normally initiated on this channel. Then, except in an emergency, you must switch to a working channel. It is ***against FCC regulations to conduct business on this channel***. In addition, vessels calling must use their assigned call sign at the beginning and end of each transmission.

Channel 22A

(157.100 MHz) is the US Coast Guard Liaison Channel. This channel is used for communications with Coast Guard ships, aircraft, and coastal stations after first establishing contact on channel 16. Navigational warnings and, where not available on WX channels, Marine Weather forecasts are also broadcast on this frequency.

SSB Radios

To communicate over distances beyond twenty miles, you need to use satellite communication or a medium to-high frequency radiotelephone referred to as Single Side Band (SSB) radio. All ship SSE radiotelephones must be capable of operating ***frequency 2182 kHz, the international distress and calling frequency***, and at least 2 other frequencies. Frequency 2670 kHz is only used for communicating with the Coast Guard and should not be used for other purposes.

When using SSB radiotelephone, you must observe radio silence at Frequency 2182 kHz, the emergency channel, for 3 minutes immediately after the hour and the half-hour. The purpose of radio silence on the emergency hailing channel is to clear the airwaves for weak or distant distress signals. No radio silence is used on the VHF emergency channel.

Every ship and all Coast Guard stations continually listen to the emergency frequencies. These channels cannot be used for other communication and extraneous conversation is illegal and dangerous. The emergency channels are:

- VHF Channel 16 (international distress channel)
- VHF Channel 13 (for ships to use to avoid collisions, cannot be used to contact the USCG shore stations)
- SSB Frequency 2182 (international distress frequency)

If you are required to send an emergency message or relay information to the Coast Guard, use the following procedures:

- When trying to establish communications, repeat the USCG Station's name and your name at least twice.
- Use radio punctuation words ("over," "clear," "out," "roger," "say again," "standing by," and "break"). Radios transmit in only one direction at a time and these words signal your intentions to the receiving station. Speak directly into the microphone, speaking loudly, slowly, and distinctly.

- To be clear when using letters (for call signs or other codes), use the phonetic alphabet:

| | |
|------------------|--------------|
| A = Alpha | N = November |
| B = Bravo | O = Oscar |
| C = Charlie | P = Papa |
| D = Delta | Q = Quebec |
| E = Echo | R = Romeo |
| F = Foxtrot | S = Sierra |
| G = Gulf | T = Tango |
| H = Hotel | U = Uniform |
| I = India | V = Victor |
| J = Juliet | W = Whiskey |
| K = Kilo (keelo) | X = X-ray |
| L = Lima (leema) | Y = Yankee |
| M = Mike | Z = Zulu |

- Upon completing a transmission, sign off by identifying your vessel and using the words “clear” or “out.” If you expect to resume contact soon with the same station, use the phrase “standing by.”

A correctly sent message would be as follows:

You (on VHF Channel 16): Coast Guard Station Kodiak, Coast Guard Station Kodiak. This is the fishing vessel Starry Flounder, Whiskey Tango Zulu four, one, nine, zero. This is the fishing vessel Starry Flounder, Whiskey Tango Zulu four, one, nine, zero on channel sixteen, over.

USCG: Fishing vessel Starry Flounder this is Coast Guard Station Kodiak shift and answer on channel eleven, out.

You (now on VHF Channel 11): Coast Guard Station Kodiak. Coast Guard Station Kodiak. This is the Starry Flounder on channel eleven, over.

USCG: Fishing vessel Starry Flounder, this is Coast Guard Station Kodiak. Send your traffic, over.

You: Kodiak this is the Starry Flounder, I am the observer relaying a message for the captain. A crewman has a badly crushed arm and needs hospitalization. Can you evacuate the crewman? Over.

USCG: Vessel Starry Flounder, this is Kodiak. Affirmative. What is your current position? Over.

You: Kodiak this is the Starry Flounder. Position is five-five degrees five-zero minutes north, one-five seven degrees, two-four minutes west, over.

You would continue to provide information as requested by the Coast Guard until they end the communications by ending their final message with “out.”

APPENDIX AA: BEAM BALANCE FLATBED SCALE CARE AND MAINTENANCE

Flatbed scales are available from the Kodiak and Dutch Harbor field offices. They are particularly helpful on small vessels that have no convenient location to hang a 50 kg Salter scale. Although useful, these scales are delicate and expensive. They require proper care and maintenance to survive your deployment.

Before You Use the Scale

As with all scales issued to you the flatbed scale must be checked for accuracy before going into the field. Be sure to check the scale at 10 kg, 20 kg, and 35 kg. Record the results of this test in your logbook. This should serve to familiarize you with the operation of the scale.

Field Care and Use of Flatbed Scales

The Beam Balance Flatbed Scale is likely the most valuable piece of equipment issued to observers. It is important that it be treated as such to ensure its longevity. A few simple precautions and light maintenance can easily prevent irreparable damage to your scale. By following these steps the life span of these flatbed scales can be improved, and provide observers with high quality equipment. *Thanks for doing your part!*

1. Lock both the platform and the beam balance at all times when the scale is not in use. The motion of the boat keeps the scale “working” whenever it is not locked, which can wear out the scale. Lock the platform using the black knob on the right side of the scale. Turn the lever back to lock the platform and forward to unlock. To lock the beam in place use the lever that pivots up under the right side (near the balance indicator).
2. Always protect the scale from impact damage. Even seemingly moderate impacts to the balance or the unlocked platform can damage the floating hangers under the scale. Once these hangers are damaged the precision of the scale is forever and irreparably compromised. Do not drop baskets of fish onto the platform. Do not throw fish into baskets on the platform. Fill your baskets and then place them on the platform.
3. Keep the scale as clean and dry as possible. These scales are not designed for the marine environment. Corrosion of the internal hangers, zero adjustment and poise weights are the leading cause of scale

damage. Rinse the scale off when finished with it, *preferably with fresh water*, and store it in a dry location until its next use.

4. Lubricate the scale often. Lubricate the poise weight bars, the zero adjustment and the floating hangers under the scale with a light oil as often as possible. This will reduce corrosion and improve the performance of the scale.
5. Move the zero adjustment daily. The zero adjustment assembly (located on the top left side of the balance beam) is the first part of the scale to fail due to corrosion. The weight and screw are prone to seize together. Be sure to move it at least five full turns every day to prevent this. Lubricate it often with a product such as WD-40 or LPS, commonly found on boats.

For information on taring this scale “Taring Your Scales” on page 2-28.

If you have any questions about the use or care of your flatbed scale please consult a staff member.

Returning the Scale

Before checking-in the scale, *rinse it well with fresh water*. The scale will need to be retested upon your return. Test the scale at 10 kg, 20kg, and 35 kg and record the results in your logbook. Check the results against the NMFS acceptable accuracy range. If your scale does not fall within acceptable limits be sure to note this in your logbook and bring it up during your debriefing.

**APPENDIX AB: NMFS-PERMITTED CONTRACTORS FOR THE FISHERIES
MONITORING AND ANALYSIS DIVISION**

AIS, Inc.
3216 NE 45th Place
Suite 106
Seattle, WA 98105
Phone: 855-247-6746
Fax: (206) 403-1200
E-mail: npgop@aisobservers.com
www.aisobservers.com

Alaskan Observers, Inc. (AOI)
130 Nickerson, Suite 206
Seattle, WA 98109
Phone: (206) 283-7310
Fax: (206) 283-6519
E-mail: aoistaff@alaskanobservers.com
www.alaskanobservers.com

Saltwater, Inc. (SWI)
1912 NW Dock Place
Seattle, WA 98107
Phone: (206) 588-1401
Fax: (206) 829-8573
E-mail: stacey.hansen@saltwaterinc.com,
jennifer.lebeau@saltwaterinc.com
www.saltwaterinc.com

Use This Table to Determine Your Sampling Interval

Choose a random number within the interval

80 kg Sample Unit/Sample Size

| <i>Haul Est. (mt)</i> | <i>Number of Intended Samples</i> | | | | | | | | | |
|-----------------------|-----------------------------------|----------|----------|----------|----------|----------|----------|----------|----------|-----------|
| | <i>1</i> | <i>2</i> | <i>3</i> | <i>4</i> | <i>5</i> | <i>6</i> | <i>7</i> | <i>8</i> | <i>9</i> | <i>10</i> |
| 5 | 63 | 31 | 21 | 16 | 13 | 10 | 9 | 8 | 7 | 6 |
| 10 | 125 | 63 | 42 | 31 | 25 | 21 | 18 | 16 | 14 | 13 |
| 15 | 188 | 94 | 63 | 47 | 38 | 31 | 27 | 23 | 21 | 19 |
| 20 | 250 | 125 | 83 | 63 | 50 | 42 | 36 | 31 | 28 | 25 |
| 30 | 375 | 188 | 125 | 94 | 75 | 63 | 54 | 47 | 42 | 38 |
| 40 | 500 | 250 | 167 | 125 | 100 | 83 | 71 | 63 | 56 | 50 |
| 50 | 625 | 313 | 208 | 156 | 125 | 104 | 89 | 78 | 69 | 63 |
| 60 | 750 | 375 | 250 | 188 | 150 | 125 | 107 | 94 | 83 | 75 |
| 70 | 875 | 438 | 292 | 219 | 175 | 146 | 125 | 109 | 97 | 88 |
| 80 | 1000 | 500 | 333 | 250 | 200 | 167 | 143 | 125 | 111 | 100 |
| 90 | 1125 | 563 | 375 | 281 | 225 | 188 | 161 | 141 | 125 | 113 |
| 100 | 1250 | 625 | 417 | 313 | 250 | 208 | 179 | 156 | 139 | 125 |
| 110 | 1375 | 688 | 458 | 344 | 275 | 229 | 196 | 172 | 153 | 138 |
| 120 | 1500 | 750 | 500 | 375 | 300 | 250 | 214 | 188 | 167 | 150 |
| 125 | 1563 | 781 | 521 | 391 | 313 | 260 | 223 | 195 | 174 | 156 |
| 130 | 1625 | 813 | 542 | 406 | 325 | 271 | 232 | 203 | 181 | 163 |
| 140 | 1750 | 875 | 583 | 438 | 350 | 292 | 250 | 219 | 194 | 175 |
| 150 | 1875 | 938 | 625 | 469 | 375 | 313 | 268 | 234 | 208 | 188 |
| 160 | 2000 | 1000 | 667 | 500 | 400 | 333 | 286 | 250 | 222 | 200 |
| 170 | 2125 | 1063 | 708 | 531 | 425 | 354 | 304 | 266 | 236 | 213 |
| 180 | 2250 | 1125 | 750 | 563 | 450 | 375 | 321 | 281 | 250 | 225 |
| 190 | 2375 | 1188 | 792 | 594 | 475 | 396 | 339 | 297 | 264 | 238 |
| 200 | 2500 | 1250 | 833 | 625 | 500 | 417 | 357 | 313 | 278 | 250 |
| 210 | 2625 | 1313 | 875 | 656 | 525 | 438 | 375 | 328 | 292 | 263 |
| 220 | 2750 | 1375 | 917 | 688 | 550 | 458 | 393 | 344 | 306 | 275 |
| 230 | 2875 | 1438 | 958 | 719 | 575 | 479 | 411 | 359 | 319 | 288 |
| 240 | 3000 | 1500 | 1000 | 750 | 600 | 500 | 429 | 375 | 333 | 300 |
| 250 | 3125 | 1563 | 1042 | 781 | 625 | 521 | 446 | 391 | 347 | 313 |

Use this Table to Estimate the Approximate Time

80 kg sample unit/sample size

Estimate of Time to Process (minutes)

| Haul Est. (mt) | 120 | 110 | 100 | 90 | 80 | 70 | 60 | 50 | 45 | 30 | 20 | 15 | 10 | 5 |
|----------------|-------|-------|-------|-------|-------|-------|-------|-------|-------|-------|-------|-------|-------|-------|
| 5 | 1.920 | 1.760 | 1.600 | 1.440 | 1.280 | 1.120 | 0.960 | 0.800 | 0.720 | 0.480 | 0.320 | 0.240 | 0.160 | 0.080 |
| 10 | 0.960 | 0.880 | 0.800 | 0.720 | 0.640 | 0.560 | 0.480 | 0.400 | 0.360 | 0.240 | 0.160 | 0.120 | 0.080 | 0.040 |
| 15 | 0.640 | 0.587 | 0.533 | 0.480 | 0.427 | 0.373 | 0.320 | 0.267 | 0.240 | 0.160 | 0.107 | 0.080 | 0.053 | 0.027 |
| 20 | 0.480 | 0.440 | 0.400 | 0.360 | 0.320 | 0.280 | 0.240 | 0.200 | 0.180 | 0.120 | 0.080 | 0.060 | 0.040 | 0.020 |
| 30 | 0.320 | 0.293 | 0.267 | 0.240 | 0.213 | 0.187 | 0.160 | 0.133 | 0.120 | 0.080 | 0.053 | 0.040 | 0.027 | 0.013 |
| 40 | 0.240 | 0.220 | 0.200 | 0.180 | 0.160 | 0.140 | 0.120 | 0.100 | 0.090 | 0.060 | 0.040 | 0.030 | 0.020 | 0.010 |
| 50 | 0.192 | 0.176 | 0.160 | 0.144 | 0.128 | 0.112 | 0.096 | 0.080 | 0.072 | 0.048 | 0.032 | 0.024 | 0.016 | 0.008 |
| 60 | 0.160 | 0.147 | 0.133 | 0.120 | 0.107 | 0.093 | 0.080 | 0.067 | 0.060 | 0.040 | 0.027 | 0.020 | 0.013 | 0.007 |
| 70 | 0.137 | 0.126 | 0.114 | 0.103 | 0.091 | 0.080 | 0.069 | 0.057 | 0.051 | 0.034 | 0.023 | 0.017 | 0.011 | 0.006 |
| 80 | 0.120 | 0.110 | 0.100 | 0.090 | 0.080 | 0.070 | 0.060 | 0.050 | 0.045 | 0.030 | 0.020 | 0.015 | 0.010 | 0.005 |
| 90 | 0.107 | 0.098 | 0.089 | 0.080 | 0.071 | 0.062 | 0.053 | 0.044 | 0.040 | 0.027 | 0.018 | 0.013 | 0.009 | 0.004 |
| 100 | 0.096 | 0.088 | 0.080 | 0.072 | 0.064 | 0.056 | 0.048 | 0.040 | 0.036 | 0.024 | 0.016 | 0.012 | 0.008 | 0.004 |
| 110 | 0.087 | 0.080 | 0.073 | 0.065 | 0.058 | 0.051 | 0.044 | 0.036 | 0.033 | 0.022 | 0.015 | 0.011 | 0.007 | 0.004 |
| 120 | 0.080 | 0.073 | 0.067 | 0.060 | 0.053 | 0.047 | 0.040 | 0.033 | 0.030 | 0.020 | 0.013 | 0.010 | 0.007 | 0.003 |
| 125 | 0.077 | 0.070 | 0.064 | 0.058 | 0.051 | 0.045 | 0.038 | 0.032 | 0.029 | 0.019 | 0.013 | 0.010 | 0.006 | 0.003 |
| 130 | 0.074 | 0.068 | 0.062 | 0.055 | 0.049 | 0.043 | 0.037 | 0.031 | 0.028 | 0.018 | 0.012 | 0.009 | 0.006 | 0.003 |
| 140 | 0.069 | 0.063 | 0.057 | 0.051 | 0.046 | 0.040 | 0.034 | 0.029 | 0.026 | 0.017 | 0.011 | 0.009 | 0.006 | 0.003 |
| 150 | 0.064 | 0.059 | 0.053 | 0.048 | 0.043 | 0.037 | 0.032 | 0.027 | 0.024 | 0.016 | 0.011 | 0.008 | 0.005 | 0.003 |
| 160 | 0.060 | 0.055 | 0.050 | 0.045 | 0.040 | 0.035 | 0.030 | 0.025 | 0.023 | 0.015 | 0.010 | 0.008 | 0.005 | 0.003 |
| 170 | 0.056 | 0.052 | 0.047 | 0.042 | 0.038 | 0.033 | 0.028 | 0.024 | 0.021 | 0.014 | 0.009 | 0.007 | 0.005 | 0.002 |
| 180 | 0.053 | 0.049 | 0.044 | 0.040 | 0.036 | 0.031 | 0.027 | 0.022 | 0.020 | 0.013 | 0.009 | 0.007 | 0.004 | 0.002 |
| 190 | 0.051 | 0.046 | 0.042 | 0.038 | 0.034 | 0.029 | 0.025 | 0.021 | 0.019 | 0.013 | 0.008 | 0.006 | 0.004 | 0.002 |
| 200 | 0.048 | 0.044 | 0.040 | 0.036 | 0.032 | 0.028 | 0.024 | 0.020 | 0.018 | 0.012 | 0.008 | 0.006 | 0.004 | 0.002 |
| 210 | 0.046 | 0.042 | 0.038 | 0.034 | 0.030 | 0.027 | 0.023 | 0.019 | 0.017 | 0.011 | 0.008 | 0.006 | 0.004 | 0.002 |
| 220 | 0.044 | 0.040 | 0.036 | 0.033 | 0.029 | 0.025 | 0.022 | 0.018 | 0.016 | 0.011 | 0.007 | 0.005 | 0.004 | 0.002 |
| 230 | 0.042 | 0.038 | 0.035 | 0.031 | 0.028 | 0.024 | 0.021 | 0.017 | 0.016 | 0.010 | 0.007 | 0.005 | 0.003 | 0.002 |
| 240 | 0.040 | 0.037 | 0.033 | 0.030 | 0.027 | 0.023 | 0.020 | 0.017 | 0.015 | 0.010 | 0.007 | 0.005 | 0.003 | 0.002 |
| 250 | 0.038 | 0.035 | 0.032 | 0.029 | 0.026 | 0.022 | 0.019 | 0.016 | 0.014 | 0.010 | 0.006 | 0.005 | 0.003 | 0.002 |

Multiply these times in decimal minutes by your randomly selected unit number to estimate when your sample unit should be available

Use This Table to Determine Your Sampling Interval

Choose a random number within the interval

100 kg Sample Unit/Sample Size

Number of Intended Samples

| Haul Est. (mt) | 1 | 2 | 3 | 4 | 5 | 6 | 7 | 8 | 9 | 10 |
|-----------------------|----------|----------|----------|----------|----------|----------|----------|----------|----------|-----------|
| 5 | 50 | 25 | 17 | 13 | 10 | 8 | 7 | 6 | 6 | 5 |
| 10 | 100 | 50 | 33 | 25 | 20 | 17 | 14 | 13 | 11 | 10 |
| 15 | 150 | 75 | 50 | 38 | 30 | 25 | 21 | 19 | 17 | 15 |
| 20 | 200 | 100 | 67 | 50 | 40 | 33 | 29 | 25 | 22 | 20 |
| 30 | 300 | 150 | 100 | 75 | 60 | 50 | 43 | 38 | 33 | 30 |
| 40 | 400 | 200 | 133 | 100 | 80 | 67 | 57 | 50 | 44 | 40 |
| 50 | 500 | 250 | 167 | 125 | 100 | 83 | 71 | 63 | 56 | 50 |
| 60 | 600 | 300 | 200 | 150 | 120 | 100 | 86 | 75 | 67 | 60 |
| 70 | 700 | 350 | 233 | 175 | 140 | 117 | 100 | 88 | 78 | 70 |
| 80 | 800 | 400 | 267 | 200 | 160 | 133 | 114 | 100 | 89 | 80 |
| 90 | 900 | 450 | 300 | 225 | 180 | 150 | 129 | 113 | 100 | 90 |
| 100 | 1000 | 500 | 333 | 250 | 200 | 167 | 143 | 125 | 111 | 100 |
| 110 | 1100 | 550 | 367 | 275 | 220 | 183 | 157 | 138 | 122 | 110 |
| 120 | 1200 | 600 | 400 | 300 | 240 | 200 | 171 | 150 | 133 | 120 |
| 125 | 1250 | 625 | 417 | 313 | 250 | 208 | 179 | 156 | 139 | 125 |
| 130 | 1300 | 650 | 433 | 325 | 260 | 217 | 186 | 163 | 144 | 130 |
| 140 | 1400 | 700 | 467 | 350 | 280 | 233 | 200 | 175 | 156 | 140 |
| 150 | 1500 | 750 | 500 | 375 | 300 | 250 | 214 | 188 | 167 | 150 |
| 160 | 1600 | 800 | 533 | 400 | 320 | 267 | 229 | 200 | 178 | 160 |
| 170 | 1700 | 850 | 567 | 425 | 340 | 283 | 243 | 213 | 189 | 170 |
| 180 | 1800 | 900 | 600 | 450 | 360 | 300 | 257 | 225 | 200 | 180 |
| 190 | 1900 | 950 | 633 | 475 | 380 | 317 | 271 | 238 | 211 | 190 |
| 200 | 2000 | 1000 | 667 | 500 | 400 | 333 | 286 | 250 | 222 | 200 |
| 210 | 2100 | 1050 | 700 | 525 | 420 | 350 | 300 | 263 | 233 | 210 |
| 220 | 2200 | 1100 | 733 | 550 | 440 | 367 | 314 | 275 | 244 | 220 |
| 230 | 2300 | 1150 | 767 | 575 | 460 | 383 | 329 | 288 | 256 | 230 |
| 240 | 2400 | 1200 | 800 | 600 | 480 | 400 | 343 | 300 | 267 | 240 |
| 250 | 2500 | 1250 | 833 | 625 | 500 | 417 | 357 | 313 | 278 | 250 |

Use this Table to Estimate the Approximate Time

100 kg sample unit/sample size

Estimate of Time to Process (minutes)

| Haul Est. (mt) | 120 | 110 | 100 | 90 | 80 | 70 | 60 | 50 | 45 | 30 | 20 | 15 | 10 | 5 |
|---------------------------|------------|------------|------------|-----------|-----------|-----------|-----------|-----------|-----------|-----------|-----------|-----------|-----------|----------|
| 5 | 2.400 | 2.200 | 2.000 | 1.800 | 1.600 | 1.400 | 1.200 | 1.000 | 0.900 | 0.600 | 0.400 | 0.300 | 0.200 | 0.100 |
| 10 | 1.200 | 1.100 | 1.000 | 0.900 | 0.800 | 0.700 | 0.600 | 0.500 | 0.450 | 0.300 | 0.200 | 0.150 | 0.100 | 0.050 |
| 15 | 0.800 | 0.733 | 0.667 | 0.600 | 0.533 | 0.467 | 0.400 | 0.333 | 0.300 | 0.200 | 0.133 | 0.100 | 0.067 | 0.033 |
| 20 | 0.600 | 0.550 | 0.500 | 0.450 | 0.400 | 0.350 | 0.300 | 0.250 | 0.225 | 0.150 | 0.100 | 0.075 | 0.050 | 0.025 |
| 30 | 0.400 | 0.367 | 0.333 | 0.300 | 0.267 | 0.233 | 0.200 | 0.167 | 0.150 | 0.100 | 0.067 | 0.050 | 0.033 | 0.017 |
| 40 | 0.300 | 0.275 | 0.250 | 0.225 | 0.200 | 0.175 | 0.150 | 0.125 | 0.113 | 0.075 | 0.050 | 0.038 | 0.025 | 0.013 |
| 50 | 0.240 | 0.220 | 0.200 | 0.180 | 0.160 | 0.140 | 0.120 | 0.100 | 0.090 | 0.060 | 0.040 | 0.030 | 0.020 | 0.010 |
| 60 | 0.200 | 0.183 | 0.167 | 0.150 | 0.133 | 0.117 | 0.100 | 0.083 | 0.075 | 0.050 | 0.033 | 0.025 | 0.017 | 0.008 |
| 70 | 0.171 | 0.157 | 0.143 | 0.129 | 0.114 | 0.100 | 0.086 | 0.071 | 0.064 | 0.043 | 0.029 | 0.021 | 0.014 | 0.007 |
| 80 | 0.150 | 0.138 | 0.125 | 0.113 | 0.100 | 0.088 | 0.075 | 0.063 | 0.056 | 0.038 | 0.025 | 0.019 | 0.013 | 0.006 |
| 90 | 0.133 | 0.122 | 0.111 | 0.100 | 0.089 | 0.078 | 0.067 | 0.056 | 0.050 | 0.033 | 0.022 | 0.017 | 0.011 | 0.006 |
| 100 | 0.120 | 0.110 | 0.100 | 0.090 | 0.080 | 0.070 | 0.060 | 0.050 | 0.045 | 0.030 | 0.020 | 0.015 | 0.010 | 0.005 |
| 110 | 0.109 | 0.100 | 0.091 | 0.082 | 0.073 | 0.064 | 0.055 | 0.045 | 0.041 | 0.027 | 0.018 | 0.014 | 0.009 | 0.005 |
| 120 | 0.100 | 0.092 | 0.083 | 0.075 | 0.067 | 0.058 | 0.050 | 0.042 | 0.038 | 0.025 | 0.017 | 0.013 | 0.008 | 0.004 |
| 125 | 0.096 | 0.088 | 0.080 | 0.072 | 0.064 | 0.056 | 0.048 | 0.040 | 0.036 | 0.024 | 0.016 | 0.012 | 0.008 | 0.004 |
| 130 | 0.092 | 0.085 | 0.077 | 0.069 | 0.062 | 0.054 | 0.046 | 0.038 | 0.035 | 0.023 | 0.015 | 0.012 | 0.008 | 0.004 |
| 140 | 0.086 | 0.079 | 0.071 | 0.064 | 0.057 | 0.050 | 0.043 | 0.036 | 0.032 | 0.021 | 0.014 | 0.011 | 0.007 | 0.004 |
| 150 | 0.080 | 0.073 | 0.067 | 0.060 | 0.053 | 0.047 | 0.040 | 0.033 | 0.030 | 0.020 | 0.013 | 0.010 | 0.007 | 0.003 |
| 160 | 0.075 | 0.069 | 0.063 | 0.056 | 0.050 | 0.044 | 0.038 | 0.031 | 0.028 | 0.019 | 0.013 | 0.009 | 0.006 | 0.003 |
| 170 | 0.071 | 0.065 | 0.059 | 0.053 | 0.047 | 0.041 | 0.035 | 0.029 | 0.026 | 0.018 | 0.012 | 0.009 | 0.006 | 0.003 |
| 180 | 0.067 | 0.061 | 0.056 | 0.050 | 0.044 | 0.039 | 0.033 | 0.028 | 0.025 | 0.017 | 0.011 | 0.008 | 0.006 | 0.003 |
| 190 | 0.063 | 0.058 | 0.053 | 0.047 | 0.042 | 0.037 | 0.032 | 0.026 | 0.024 | 0.016 | 0.011 | 0.008 | 0.005 | 0.003 |
| 200 | 0.060 | 0.055 | 0.050 | 0.045 | 0.040 | 0.035 | 0.030 | 0.025 | 0.023 | 0.015 | 0.010 | 0.008 | 0.005 | 0.003 |
| 210 | 0.057 | 0.052 | 0.048 | 0.043 | 0.038 | 0.033 | 0.029 | 0.024 | 0.021 | 0.014 | 0.010 | 0.007 | 0.005 | 0.002 |
| 220 | 0.055 | 0.050 | 0.045 | 0.041 | 0.036 | 0.032 | 0.027 | 0.023 | 0.020 | 0.014 | 0.009 | 0.007 | 0.005 | 0.002 |
| 230 | 0.052 | 0.048 | 0.043 | 0.039 | 0.035 | 0.030 | 0.026 | 0.022 | 0.020 | 0.013 | 0.009 | 0.007 | 0.004 | 0.002 |
| 240 | 0.050 | 0.046 | 0.042 | 0.038 | 0.033 | 0.029 | 0.025 | 0.021 | 0.019 | 0.013 | 0.008 | 0.006 | 0.004 | 0.002 |
| 250 | 0.048 | 0.044 | 0.040 | 0.036 | 0.032 | 0.028 | 0.024 | 0.020 | 0.018 | 0.012 | 0.008 | 0.006 | 0.004 | 0.002 |

Multiply these times in decimal minutes by your randomly selected unit number to estimate when your sample unit should be available

Use This Table to Determine Your Sampling Interval

Choose a random number with-in the interval

120 kg Sample Unit/Sample Size

Number of Intended Samples

| <i>Haul Est. (mt)</i> | <i>1</i> | <i>2</i> | <i>3</i> | <i>4</i> | <i>5</i> | <i>6</i> | <i>7</i> | <i>8</i> | <i>9</i> | <i>10</i> |
|-----------------------|----------|----------|----------|----------|----------|----------|----------|----------|----------|-----------|
| 5 | 42 | 21 | 14 | 10 | 8 | 7 | 6 | 5 | 5 | 4 |
| 10 | 83 | 42 | 28 | 21 | 17 | 14 | 12 | 10 | 9 | 8 |
| 15 | 125 | 63 | 42 | 31 | 25 | 21 | 18 | 16 | 14 | 13 |
| 20 | 167 | 83 | 56 | 42 | 33 | 28 | 24 | 21 | 19 | 17 |
| 30 | 250 | 125 | 83 | 63 | 50 | 42 | 36 | 31 | 28 | 25 |
| 40 | 333 | 167 | 111 | 83 | 67 | 56 | 48 | 42 | 37 | 33 |
| 50 | 417 | 208 | 139 | 104 | 83 | 69 | 60 | 52 | 46 | 42 |
| 60 | 500 | 250 | 167 | 125 | 100 | 83 | 71 | 63 | 56 | 50 |
| 70 | 583 | 292 | 194 | 146 | 117 | 97 | 83 | 73 | 65 | 58 |
| 80 | 667 | 333 | 222 | 167 | 133 | 111 | 95 | 83 | 74 | 67 |
| 90 | 750 | 375 | 250 | 188 | 150 | 125 | 107 | 94 | 83 | 75 |
| 100 | 833 | 417 | 278 | 208 | 167 | 139 | 119 | 104 | 93 | 83 |
| 110 | 917 | 458 | 306 | 229 | 183 | 153 | 131 | 115 | 102 | 92 |
| 120 | 1000 | 500 | 333 | 250 | 200 | 167 | 143 | 125 | 111 | 100 |
| 125 | 1042 | 521 | 347 | 260 | 208 | 174 | 149 | 130 | 116 | 104 |
| 130 | 1083 | 542 | 361 | 271 | 217 | 181 | 155 | 135 | 120 | 108 |
| 140 | 1167 | 583 | 389 | 292 | 233 | 194 | 167 | 146 | 130 | 117 |
| 150 | 1250 | 625 | 417 | 313 | 250 | 208 | 179 | 156 | 139 | 125 |
| 160 | 1333 | 667 | 444 | 333 | 267 | 222 | 190 | 167 | 148 | 133 |
| 170 | 1417 | 708 | 472 | 354 | 283 | 236 | 202 | 177 | 157 | 142 |
| 180 | 1500 | 750 | 500 | 375 | 300 | 250 | 214 | 188 | 167 | 150 |
| 190 | 1583 | 792 | 528 | 396 | 317 | 264 | 226 | 198 | 176 | 158 |
| 200 | 1667 | 833 | 556 | 417 | 333 | 278 | 238 | 208 | 185 | 167 |
| 210 | 1750 | 875 | 583 | 438 | 350 | 292 | 250 | 219 | 194 | 175 |
| 220 | 1833 | 917 | 611 | 458 | 367 | 306 | 262 | 229 | 204 | 183 |
| 230 | 1917 | 958 | 639 | 479 | 383 | 319 | 274 | 240 | 213 | 192 |
| 240 | 2000 | 1000 | 667 | 500 | 400 | 333 | 286 | 250 | 222 | 200 |
| 250 | 2083 | 1042 | 694 | 521 | 417 | 347 | 298 | 260 | 231 | 208 |

Use this Table to Estimate the Approximate Time

120 kg sample unit/sample size

Estimate of Time to Process (minutes)

| Haul Est. (mt) | 120 | 110 | 100 | 90 | 80 | 70 | 60 | 50 | 45 | 30 | 20 | 15 | 10 | 5 |
|----------------|-------|-------|-------|-------|-------|-------|-------|-------|-------|-------|-------|-------|-------|-------|
| 5 | 2.880 | 2.640 | 2.400 | 2.160 | 1.920 | 1.680 | 1.440 | 1.200 | 1.080 | 0.720 | 0.480 | 0.360 | 0.240 | 0.120 |
| 10 | 1.440 | 1.320 | 1.200 | 1.080 | 0.960 | 0.840 | 0.720 | 0.600 | 0.540 | 0.360 | 0.240 | 0.180 | 0.120 | 0.060 |
| 15 | 0.960 | 0.880 | 0.800 | 0.720 | 0.640 | 0.560 | 0.480 | 0.400 | 0.360 | 0.240 | 0.160 | 0.120 | 0.080 | 0.040 |
| 20 | 0.720 | 0.660 | 0.600 | 0.540 | 0.480 | 0.420 | 0.360 | 0.300 | 0.270 | 0.180 | 0.120 | 0.090 | 0.060 | 0.030 |
| 30 | 0.480 | 0.440 | 0.400 | 0.360 | 0.320 | 0.280 | 0.240 | 0.200 | 0.180 | 0.120 | 0.080 | 0.060 | 0.040 | 0.020 |
| 40 | 0.360 | 0.330 | 0.300 | 0.270 | 0.240 | 0.210 | 0.180 | 0.150 | 0.135 | 0.090 | 0.060 | 0.045 | 0.030 | 0.015 |
| 50 | 0.288 | 0.264 | 0.240 | 0.216 | 0.192 | 0.168 | 0.144 | 0.120 | 0.108 | 0.072 | 0.048 | 0.036 | 0.024 | 0.012 |
| 60 | 0.240 | 0.220 | 0.200 | 0.180 | 0.160 | 0.140 | 0.120 | 0.100 | 0.090 | 0.060 | 0.040 | 0.030 | 0.020 | 0.010 |
| 70 | 0.206 | 0.189 | 0.171 | 0.154 | 0.137 | 0.120 | 0.103 | 0.086 | 0.077 | 0.051 | 0.034 | 0.026 | 0.017 | 0.009 |
| 80 | 0.180 | 0.165 | 0.150 | 0.135 | 0.120 | 0.105 | 0.090 | 0.075 | 0.068 | 0.045 | 0.030 | 0.023 | 0.015 | 0.008 |
| 90 | 0.160 | 0.147 | 0.133 | 0.120 | 0.107 | 0.093 | 0.080 | 0.067 | 0.060 | 0.040 | 0.027 | 0.020 | 0.013 | 0.007 |
| 100 | 0.144 | 0.132 | 0.120 | 0.108 | 0.096 | 0.084 | 0.072 | 0.060 | 0.054 | 0.036 | 0.024 | 0.018 | 0.012 | 0.006 |
| 110 | 0.131 | 0.120 | 0.109 | 0.098 | 0.087 | 0.076 | 0.065 | 0.055 | 0.049 | 0.033 | 0.022 | 0.016 | 0.011 | 0.005 |
| 120 | 0.120 | 0.110 | 0.100 | 0.090 | 0.080 | 0.070 | 0.060 | 0.050 | 0.045 | 0.030 | 0.020 | 0.015 | 0.010 | 0.005 |
| 125 | 0.115 | 0.106 | 0.096 | 0.086 | 0.077 | 0.067 | 0.058 | 0.048 | 0.043 | 0.029 | 0.019 | 0.014 | 0.010 | 0.005 |
| 130 | 0.111 | 0.102 | 0.092 | 0.083 | 0.074 | 0.065 | 0.055 | 0.046 | 0.042 | 0.028 | 0.018 | 0.014 | 0.009 | 0.005 |
| 140 | 0.103 | 0.094 | 0.086 | 0.077 | 0.069 | 0.060 | 0.051 | 0.043 | 0.039 | 0.026 | 0.017 | 0.013 | 0.009 | 0.004 |
| 150 | 0.096 | 0.088 | 0.080 | 0.072 | 0.064 | 0.056 | 0.048 | 0.040 | 0.036 | 0.024 | 0.016 | 0.012 | 0.008 | 0.004 |
| 160 | 0.090 | 0.083 | 0.075 | 0.068 | 0.060 | 0.053 | 0.045 | 0.038 | 0.034 | 0.023 | 0.015 | 0.011 | 0.008 | 0.004 |
| 170 | 0.085 | 0.078 | 0.071 | 0.064 | 0.056 | 0.049 | 0.042 | 0.035 | 0.032 | 0.021 | 0.014 | 0.011 | 0.007 | 0.004 |
| 180 | 0.080 | 0.073 | 0.067 | 0.060 | 0.053 | 0.047 | 0.040 | 0.033 | 0.030 | 0.020 | 0.013 | 0.010 | 0.007 | 0.003 |
| 190 | 0.076 | 0.069 | 0.063 | 0.057 | 0.051 | 0.044 | 0.038 | 0.032 | 0.028 | 0.019 | 0.013 | 0.009 | 0.006 | 0.003 |
| 200 | 0.072 | 0.066 | 0.060 | 0.054 | 0.048 | 0.042 | 0.036 | 0.030 | 0.027 | 0.018 | 0.012 | 0.009 | 0.006 | 0.003 |
| 210 | 0.069 | 0.063 | 0.057 | 0.051 | 0.046 | 0.040 | 0.034 | 0.029 | 0.026 | 0.017 | 0.011 | 0.009 | 0.006 | 0.003 |
| 220 | 0.065 | 0.060 | 0.055 | 0.049 | 0.044 | 0.038 | 0.033 | 0.027 | 0.025 | 0.016 | 0.011 | 0.008 | 0.005 | 0.003 |
| 230 | 0.063 | 0.057 | 0.052 | 0.047 | 0.042 | 0.037 | 0.031 | 0.026 | 0.023 | 0.016 | 0.010 | 0.008 | 0.005 | 0.003 |
| 240 | 0.060 | 0.055 | 0.050 | 0.045 | 0.040 | 0.035 | 0.030 | 0.025 | 0.023 | 0.015 | 0.010 | 0.008 | 0.005 | 0.003 |
| 250 | 0.058 | 0.053 | 0.048 | 0.043 | 0.038 | 0.034 | 0.029 | 0.024 | 0.022 | 0.014 | 0.010 | 0.007 | 0.005 | 0.002 |

Multiply these times in decimal minutes by your randomly selected unit number to estimate when your sample unit should be available

Use This Table to Determine Your Sampling Interval

Choose a random number within the interval

150 kg Sample Unit/Sample Size

Number of Intended Samples

| <i>Haul Est. (mt)</i> | 1 | 2 | 3 | 4 | 5 | 6 | 7 | 8 | 9 | 10 |
|-----------------------|------|-----|-----|-----|-----|-----|-----|-----|-----|-----|
| 5 | 33 | 17 | 11 | 8 | 7 | 6 | 5 | 4 | 4 | 3 |
| 10 | 67 | 33 | 22 | 17 | 13 | 11 | 10 | 8 | 7 | 7 |
| 15 | 100 | 50 | 33 | 25 | 20 | 17 | 14 | 13 | 11 | 10 |
| 20 | 133 | 67 | 44 | 33 | 27 | 22 | 19 | 17 | 15 | 13 |
| 30 | 200 | 100 | 67 | 50 | 40 | 33 | 29 | 25 | 22 | 20 |
| 40 | 267 | 133 | 89 | 67 | 53 | 44 | 38 | 33 | 30 | 27 |
| 50 | 333 | 167 | 111 | 83 | 67 | 56 | 48 | 42 | 37 | 33 |
| 60 | 400 | 200 | 133 | 100 | 80 | 67 | 57 | 50 | 44 | 40 |
| 70 | 467 | 233 | 156 | 117 | 93 | 78 | 67 | 58 | 52 | 47 |
| 80 | 533 | 267 | 178 | 133 | 107 | 89 | 76 | 67 | 59 | 53 |
| 90 | 600 | 300 | 200 | 150 | 120 | 100 | 86 | 75 | 67 | 60 |
| 100 | 667 | 333 | 222 | 167 | 133 | 111 | 95 | 83 | 74 | 67 |
| 110 | 733 | 367 | 244 | 183 | 147 | 122 | 105 | 92 | 81 | 73 |
| 120 | 800 | 400 | 267 | 200 | 160 | 133 | 114 | 100 | 89 | 80 |
| 125 | 833 | 417 | 278 | 208 | 167 | 139 | 119 | 104 | 93 | 83 |
| 130 | 867 | 433 | 289 | 217 | 173 | 144 | 124 | 108 | 96 | 87 |
| 140 | 933 | 467 | 311 | 233 | 187 | 156 | 133 | 117 | 104 | 93 |
| 150 | 1000 | 500 | 333 | 250 | 200 | 167 | 143 | 125 | 111 | 100 |
| 160 | 1067 | 533 | 356 | 267 | 213 | 178 | 152 | 133 | 119 | 107 |
| 170 | 1133 | 567 | 378 | 283 | 227 | 189 | 162 | 142 | 126 | 113 |
| 180 | 1200 | 600 | 400 | 300 | 240 | 200 | 171 | 150 | 133 | 120 |
| 190 | 1267 | 633 | 422 | 317 | 253 | 211 | 181 | 158 | 141 | 127 |
| 200 | 1333 | 667 | 444 | 333 | 267 | 222 | 190 | 167 | 148 | 133 |
| 210 | 1400 | 700 | 467 | 350 | 280 | 233 | 200 | 175 | 156 | 140 |
| 220 | 1467 | 733 | 489 | 367 | 293 | 244 | 210 | 183 | 163 | 147 |
| 230 | 1533 | 767 | 511 | 383 | 307 | 256 | 219 | 192 | 170 | 153 |
| 240 | 1600 | 800 | 533 | 400 | 320 | 267 | 229 | 200 | 178 | 160 |
| 250 | 1667 | 833 | 556 | 417 | 333 | 278 | 238 | 208 | 185 | 167 |

Use this Table to Estimate the Approximate Time

150 kg sample unit/sample size

Estimate of Time to Process (minutes)

| Haul Est. (mt) | 120 | 110 | 100 | 90 | 80 | 70 | 60 | 50 | 45 | 30 | 20 | 15 | 10 | 5 |
|-------------------|-------|-------|-------|-------|-------|-------|-------|-------|-------|-------|-------|-------|-------|-------|
| 5 | 3.600 | 3.300 | 3.000 | 2.700 | 2.400 | 2.100 | 1.800 | 1.500 | 1.350 | 0.900 | 0.600 | 0.450 | 0.300 | 0.150 |
| 10 | 1.800 | 1.650 | 1.500 | 1.350 | 1.200 | 1.050 | 0.900 | 0.750 | 0.675 | 0.450 | 0.300 | 0.225 | 0.150 | 0.075 |
| 15 | 1.200 | 1.100 | 1.000 | 0.900 | 0.800 | 0.700 | 0.600 | 0.500 | 0.450 | 0.300 | 0.200 | 0.150 | 0.100 | 0.050 |
| 20 | 0.900 | 0.825 | 0.750 | 0.675 | 0.600 | 0.525 | 0.450 | 0.375 | 0.338 | 0.225 | 0.150 | 0.113 | 0.075 | 0.038 |
| 30 | 0.600 | 0.550 | 0.500 | 0.450 | 0.400 | 0.350 | 0.300 | 0.250 | 0.225 | 0.150 | 0.100 | 0.075 | 0.050 | 0.025 |
| 40 | 0.450 | 0.413 | 0.375 | 0.338 | 0.300 | 0.263 | 0.225 | 0.188 | 0.169 | 0.113 | 0.075 | 0.056 | 0.038 | 0.019 |
| 50 | 0.360 | 0.330 | 0.300 | 0.270 | 0.240 | 0.210 | 0.180 | 0.150 | 0.135 | 0.090 | 0.060 | 0.045 | 0.030 | 0.015 |
| 60 | 0.300 | 0.275 | 0.250 | 0.225 | 0.200 | 0.175 | 0.150 | 0.125 | 0.113 | 0.075 | 0.050 | 0.038 | 0.025 | 0.013 |
| 70 | 0.257 | 0.236 | 0.214 | 0.193 | 0.171 | 0.150 | 0.129 | 0.107 | 0.096 | 0.064 | 0.043 | 0.032 | 0.021 | 0.011 |
| 80 | 0.225 | 0.206 | 0.188 | 0.169 | 0.150 | 0.131 | 0.113 | 0.094 | 0.084 | 0.056 | 0.038 | 0.028 | 0.019 | 0.009 |
| 90 | 0.200 | 0.183 | 0.167 | 0.150 | 0.133 | 0.117 | 0.100 | 0.083 | 0.075 | 0.050 | 0.033 | 0.025 | 0.017 | 0.008 |
| 100 | 0.180 | 0.165 | 0.150 | 0.135 | 0.120 | 0.105 | 0.090 | 0.075 | 0.068 | 0.045 | 0.030 | 0.023 | 0.015 | 0.008 |
| 110 | 0.164 | 0.150 | 0.136 | 0.123 | 0.109 | 0.095 | 0.082 | 0.068 | 0.061 | 0.041 | 0.027 | 0.020 | 0.014 | 0.007 |
| 120 | 0.150 | 0.138 | 0.125 | 0.113 | 0.100 | 0.088 | 0.075 | 0.063 | 0.056 | 0.038 | 0.025 | 0.019 | 0.013 | 0.006 |
| 125 | 0.144 | 0.132 | 0.120 | 0.108 | 0.096 | 0.084 | 0.072 | 0.060 | 0.054 | 0.036 | 0.024 | 0.018 | 0.012 | 0.006 |
| 130 | 0.138 | 0.127 | 0.115 | 0.104 | 0.092 | 0.081 | 0.069 | 0.058 | 0.052 | 0.035 | 0.023 | 0.017 | 0.012 | 0.006 |
| 140 | 0.129 | 0.118 | 0.107 | 0.096 | 0.086 | 0.075 | 0.064 | 0.054 | 0.048 | 0.032 | 0.021 | 0.016 | 0.011 | 0.005 |
| 150 | 0.120 | 0.110 | 0.100 | 0.090 | 0.080 | 0.070 | 0.060 | 0.050 | 0.045 | 0.030 | 0.020 | 0.015 | 0.010 | 0.005 |
| 160 | 0.113 | 0.103 | 0.094 | 0.084 | 0.075 | 0.066 | 0.056 | 0.047 | 0.042 | 0.028 | 0.019 | 0.014 | 0.009 | 0.005 |
| 170 | 0.106 | 0.097 | 0.088 | 0.079 | 0.071 | 0.062 | 0.053 | 0.044 | 0.040 | 0.026 | 0.018 | 0.013 | 0.009 | 0.004 |
| 180 | 0.100 | 0.092 | 0.083 | 0.075 | 0.067 | 0.058 | 0.050 | 0.042 | 0.038 | 0.025 | 0.017 | 0.013 | 0.008 | 0.004 |
| 190 | 0.095 | 0.087 | 0.079 | 0.071 | 0.063 | 0.055 | 0.047 | 0.039 | 0.036 | 0.024 | 0.016 | 0.012 | 0.008 | 0.004 |
| 200 | 0.090 | 0.083 | 0.075 | 0.068 | 0.060 | 0.053 | 0.045 | 0.038 | 0.034 | 0.023 | 0.015 | 0.011 | 0.008 | 0.004 |
| 210 | 0.086 | 0.079 | 0.071 | 0.064 | 0.057 | 0.050 | 0.043 | 0.036 | 0.032 | 0.021 | 0.014 | 0.011 | 0.007 | 0.004 |
| 220 | 0.082 | 0.075 | 0.068 | 0.061 | 0.055 | 0.048 | 0.041 | 0.034 | 0.031 | 0.020 | 0.014 | 0.010 | 0.007 | 0.003 |
| 230 | 0.078 | 0.072 | 0.065 | 0.059 | 0.052 | 0.046 | 0.039 | 0.033 | 0.029 | 0.020 | 0.013 | 0.010 | 0.007 | 0.003 |
| 240 | 0.075 | 0.069 | 0.063 | 0.056 | 0.050 | 0.044 | 0.038 | 0.031 | 0.028 | 0.019 | 0.013 | 0.009 | 0.006 | 0.003 |
| 250 | 0.072 | 0.066 | 0.060 | 0.054 | 0.048 | 0.042 | 0.036 | 0.030 | 0.027 | 0.018 | 0.012 | 0.009 | 0.006 | 0.003 |

Multiply these times in decimal minutes by your randomly selected unit number to estimate when your sample unit should be available

APPENDIX AD: FREON INFORMATION

Dangers of Freon

- May Be Found on Factory Vessels and Catcher Vessels (for RSW systems)
- Clear and odorless-Cannot smell or see Freon
- Freon is suffocating because it displaces air
- Freon is heavier than air so it will “fall” into the vessel and sit in the bottom of compartments
- High concentrations may attack the nervous system
- When certain types of Freon come into contact with hot surfaces/high heat it may generate a poisonous gas (phosgene-similar to mustard gas). Only happens in rare circumstances with certain types of FREON
- Vessels are not required to buy a Freon detector if they use it as a refrigerant so an observer will have to rely on physical symptoms of Freon Exposure to detect a leak.

Signs and Symptoms of Exposure to Freon

- 10,000 ppm is where humans begin to show short term signs of effect. Long term exposure of lower levels (but over 1000 ppm) may cause neurological, liver, and kidney problems.
- Low Level Exposure: Headache, Nausea, vomiting, dizziness, flushed skin, respiratory difficulty, diarrhea, excitement, drowsiness. (Exposure levels of 1,000 ppm for 2.5 hrs have shown no effect)
- High Level Exposure- Unconsciousness, Death

Emergency response

- If inhaled get to fresh air immediately. Keep calm.
- If person is unconscious, immediately begin artificial respiration, give oxygen if possible

Additional Information

- Freon is a chlorofluorocarbon (destroys ozone).
- Though Freon is considered a better refrigerant by some in the industry, the majority of vessels use ammonia because it is detectable by smell and costs

less.

- Vessels stay away from Freon because it is too hazardous for their crew. If there is a Freon leak there is no way to detect it except with Freon detectors, (orange flame to blue, or ones with a sensor), which are expensive. An ammonia leak is more easily detected by crew because if there is a leak you can smell ammonia right away at very low levels of exposure.
- Even if a detector is onboard, it may not be accessible to the observer (detectors not required).

***Information collected from web sources. Contact a health professional if you have concerns with exposure to Freon.**

APPENDIX AE: ANHYDROUS AMMONIA INFORMATION

Physical Properties

Odor Threshold: 46.8 ppm - This is the lowest concentration in air that most humans can detect by smell. The value cannot be relied on to prevent overexposure, because human sensitivity to odors varies over wide limits, some chemicals cannot be smelled at toxic concentrations, odors can be masked by other odors, and some compounds rapidly deaden the sense of smell.

Threshold Limit Value: 25 ppm - Defined as the concentration of the substance in air that can be breathed for five consecutive 8-hour workdays by most people without adverse effect. As some people become ill after exposure to concentrations lower than the TLV, this value cannot be used to define exactly what is a 'safe' or 'dangerous' concentration.

Short Term Inhalation Limits: 50 ppm for 5 minutes- the maximum permissible average exposures for the time periods specified.

Symptoms of Exposure to Ammonia:

Vapor (gas) irritant characteristics:

- Vapors cause severe eye or throat irritation
- Vapors may cause eye or lung injury
- Vapors cannot be tolerated even at low concentrations

Vapor hazards:

- Poisonous if inhaled
- Irritating to eyes, nose, and throat
- Avoid contact with Ammonia vapors

Health hazards:

- NFPA level 3 - Materials, which on short exposure could cause serious temporary or residual injury even though prompt medical treatment was given.

Note: Since you normally start smelling Anhydrous Ammonia just below the maximum concentration for a 5-minute time period, the smart thing to do is to immediately leave the space!

USCG Reporting Requirement for a Hazardous Condition

33 CFR 160.215 Notice of Hazardous Condition:

Whenever there is a hazardous condition either aboard a vessel or caused by a vessel or its operation, the owner, agent, master, operator, or person in charge shall immediately notify the nearest Coast Guard Marine Safety office or Group office.

GLOSSARY**A**

ABC - “Acceptable Biological Catch” - The annual harvest level that a stock can sustain to maintain the maximum sustainable yield (MSY).

AFA - “American Fisheries Act” - This Act established a new allocation scheme for Bering Sea pollock. This Limited Access Privilege Program allowed the formation of fishing cooperatives in which participants of the Bering Sea pollock fishery divide the quota among its members. This Act also requires vessels fishing in the U.S. to be at least 75% owned by U.S. interests.

Aft - Towards the stern or back end of a vessel.

After-scale - Fish that made it past the sorters and into the factory. This bycatch may have been originally weighed as the target species and is deducted from the target species weight.

AIP- “Aleutian Islands Pollock”- The AI pollock TAC in the Aleutian Islands is fully allocated to the Aleut Corporation for the purpose of economic development in Adak, Alaska, and is managed separately. Vessels must designate AIP in their logbooks when fishing this allocation.

Alaska Local Time (ALT) - Alaska Local Time means the time in the Alaska Time Zone.

Allocation - Distribution of the opportunity to fish among user groups or individuals; sometimes based on historical harvest amounts.

Amendment 80 (A-80) - Non-AFA Catcher Processors in the Bering Sea. This amendment to the FMP of the BSAI establishes a Limited Access Privilege Program for non-pollock catcher processors in the BSAI to form cooperatives that are awarded exclusive rights to the quota of Pacific cod, yellowfin sole, rock sole, flathead sole, Atka mackerel and Pacific Ocean perch, and the associated prohibited species catch.

Amendment 91 (A-91) - Established a cap of the number of Chinook salmon that can be taken as bycatch in the Bering Sea pollock fishery. A-91 affects observer coverage on pollock CVs and observer duties at shoreside plants, pollock CVs, and pollock CPs.

Amidships - Midway between the bow and stern of a ship, or on the centerline.

Anchor/Buoy lines - Sections of line that join the groundline and anchors on the bottom of the ocean to the buoys or “bags” on the surface.

ATLAS - Software that is an electronic data entry program allowing groundfish observers to enter and send data direct from a vessel or plant to NMFS at the Alaska Fisheries Science Center in Seattle.

Autobaiters - A piece of machinery that automatically cuts bait into strips and places the strips on the hooks as the groundline is being set.

B

Bag - The codend or a buoy.

Bagging Off- Term used when a longliner stops retrieving gear, reconnects the buoy line back to the groundline and drops the line back to the bottom. Often done when marine mammals are present to avoid mammal depredation.

Bait bags/Jars - Containers filled with ground bait that are hung inside pots to attract fish.

Beam - Width of a ship.

Benthic - Living in direct relation with the bottom of the sea.

Bias- Tending to yield one outcome more frequently than others. Factors affecting the randomness of a sample, including possible mechanical sorting of catch by an incline belt or purposeful presorting by a crew member, will introduce bias.

Bight - A loop or turn in a line.

Bin - A large compartment built into a ship for holding fish. Also called live tank, refrigerated seawater tank (RSW tank), or lobby.

Bleeder/Sorter - Crewman assigned to sort bycatch out of the catch, and to cut the “throat” of the cod.

Block/Hydro/Hauler - Hydraulically driven wheel into which the groundline is placed during gear retrieval. As the wheel spins the groundline is drawn onboard.

Boat Share - The percentage of the gross TAC which goes to the vessel owner.

Bobbin - A round, rubber or steel roller used in the footrope of a bottom net to protect the net from damage.

Bosun - Person in charge of a ship’s rigging, anchors, cables, and deck crew, also known as Deck Boss.

GLOSSARY

Bottom - May refer to (1) ocean floor, (2) fishing depth, or (3) a ship hull depending on the context.

Bow - The front section of a boat or ship.

Bowline - A type of knot used to form an eye in the end of a rope.

Brailer - A type of netting that is attached to a crane and used to transport fish and other materials from one vessel to the dock or to another vessel.

Breach - A behavioral characteristic of some marine mammals such as humpback whales, where they rise vertically out of the water, and then with most of their body above the surface, they fall to their back or side.

Bridge - The control center of a ship, wheel house.

Bridle - On a trawler; a cable attached to the headrope, footrope or side panel of a net, by which the net is towed. On a pot vessel; a length of line attaching two sides of a pot to the buoyline.

Briefing - Training session observers must successfully complete to fulfill certification endorsement requirements. During briefings, observers are informed of any policy changes and review the priorities and duties on different vessel types.

BSAI- "Bering Sea and Aleutian Islands" Management Area.

Bulkhead - A wall separating compartments of a ship.

Bulwarks - The upper section of the side plating of a ship, which extends above and around the upper deck.

Buoy - A float used as a marker or warning.

Buoy line - The length of line connecting the buoy assemblage to the anchor.

Bycatch- Anything caught in fishing operations that is not the target species, such as other fish species, prohibited species, marine mammals, seabirds, invertebrates, and inert objects.

C

Calibrate - To check, adjust, or standardize, a measuring instrument, usually by comparing it with an accepted model or certified weights.

Cannonball - Lead weights attached to the groundline between gear segments helping to sink the gear and keep it on the sea floor.

Carrying capacity - The number of organisms the resources of an area can support.

Catch - The amount of fish and other organisms caught (retained or not).

Catch Per Unit Effort (CPUE) - The number of fish caught per amount of effort (generally, effort is a combination of gear type, gear size, and length of time the gear is used). CPUE can be used as a measurement of relative abundance of a caught species.

Catcher boat - Vessel that is used for catching fish and that does not process (freeze) fish on board.

Catcher/Processor - Vessel that is used for, or equipped to be used for, catching fish and processing (freezing) fish products.

CDQ - "Community Development Quota" - A portion of the TAC of the groundfish, halibut, and crab fisheries of the BSAI is allocated to residents of coastal Western Alaska, providing them with the opportunity to participate in the groundfish and crab fisheries of the BSAI. There are increased equipment and observer coverage requirements in CDQ fisheries.

Central Gulf of Alaska Rockfish Program - The Central GOA Rockfish Program (Rockfish Program) permits harvesters to form voluntary cooperatives and receive exclusive harvesting and processing privileges to selected groundfish species in the Central GOA. There are increased equipment and observer coverage requirements in Rockfish Program fisheries.

CFR - "Code of Federal Regulations" - Administrative rules and regulations by the executive departments and agencies of the Federal government. 50 CFR 600 and 679 implement the Magnuson-Stevens Act and Fisheries Management Plans for the GOA and the BSAI areas.

Chafing gear - Protective carpeting (or strands of nylon forming a carpet pile) on the outer, underside of the trawl net to keep it from catching and ripping on obstacles on the seafloor.

Checker bin - Compartments on either side of the trawl alley separated by removable boards (bin boards) for storage of gear and catch. The observer uses these bins for sampling purposes as well.

Chief - The engineer; responsible for care of engines and deck machinery.

Choker, choke strap - A loop of wire or rope used to cinch off the net or codend.

Chopper - Machine used to grind frozen herring or squid for bait or the person assigned this duty.

Cleat - A heavy piece of wood or metal having two horns around which ropes may be made fast or belayed, usually secured to a fixed object such as the dock or deck.

CMCP – “Catch Monitoring Control Plan” - This plan defines the method in which each individual plant will sort and weigh all species during any AFA or Central GOA Rockfish Program deliveries.

COBLZ – “Chionoecetes opilio Bycatch Limitation Zone” - Bycatch Limitation Area in the Northern Bering Sea for trawl fisheries. Upon attainment of the allowance of *C. opilio* crab specified for a particular fishery category, the COBLZ will be closed to directed fishing for each category for the remainder of the year or for the remainder of the season.

Coded wire tag - Small tag (3mm) etched with binary code that are inserted into the snout of fishes for later identification.

Codend - The end “bag” of a trawl net where the majority of the fish are collected and held.

Coiler - Person or machine that is designated to coil line as it is retrieved by the block.

Combi - A piece of machinery through which the groundline, gangions, and hooks move during gear retrieval. The combi mechanically places hooks into the magazine racks allowing the gangions and groundline to be hung in an orderly fashion. This term may also refer to a crew member that works both in the factory and on the deck of a factory vessel.

Combined sample – When two samples from the same haul cannot be separated and both are reported as one sample.

Combing - A low partition rising from the bottom of doors and passageways on a vessel.

Companionway - Entrance/stairway from deck to fo'c'sle and engine room.

Compliance - Being in accordance with the fishing regulations.

Composition - In the groundfish Observer Program, this refers to the makeup of harvested species in a catch, and the sample you collect.

Cookie (disc) - A flat, round piece of rubber with a hole in the center strung on a wire rope or chain to protect it from abrasion and to stir up a mud cloud. Used on non-pelagic trawl gear.

Crucifier - A pair of rollers or steel pegs which stand vertically with only enough room for the groundline to pass between. During gear retrieval the groundline passes between the rollers and the hooks are pulled out of the fish.

D

DCPL - “Daily Cumulative Production Log” – Vessel logbook kept by catcher processors to record daily fishing and processing activity.

Debriefing – Meeting with FMA Division staff at the end of an observer’s deployment to review the observer’s sampling procedures, calculations, and collected data. The observer will make corrections to the data, complete a computerized survey for each assignment, get recommendations for future cruises, and receive a written performance evaluation.

Delivery weight – The total weight of catch that is delivered from a catcher vessel to a shoreside plant or floating processor.

Demersal - Dwelling at or near the bottom of the sea.

DFL – “Daily Fishing Log” – Vessel logbook used by catcher vessels to record daily fishing activity.

Directed fishing - Targeting or fishing for a species quota.

Discard estimate – An independent estimate made by the observer of the weight of the vessel discards by haul. This estimate requires no calculations and should only take a few moments to obtain.

Discards – Catch that is not retained and is returned to the sea.

Disembark - To get off a vessel and go ashore.

Diver/Trailer buoys - A small buoy attached to the main buoy with a length of line. The diver buoy “trails” behind the main buoy and allows a larger target for grappling.

Dogs - Metal hooks that are hydraulically controlled to secure a pot to a launcher.

Donut Hole - The isolated area in the Bering Sea surrounded by waters under the jurisdiction of Alaska and Russia. This area is considered international waters and is generally closed to commercial fishing.

Door - On a trawler; a large steel or alloy structure attached in front of the net to each main wire to spread the net horizontally by means of hydrodynamic and friction forces. On a pot vessel; a panel that can be unhooked and opened to remove catch.

GLOSSARY

Draft - Vertical distance from keel to waterline of a ship.

Drop-off – On a longliner; those organisms that fall or are knocked off of a hook prior to their being landed.

Drum - A metal spool or cylinder around which cable, etc. is wound.

E

Ebb tide - Outgoing tide.

EEZ - “Exclusive Economic Zone” - The term for the 200 mile jurisdiction zone, in which a nation has exclusive fishing rights.

EM - “Electronic Monitoring” - Also known as video monitoring system. On A-91 Bering Sea pollock catcher processors and motherships EM is used to track the sorting of salmon. Also used to monitor live tanks on A-80 vessels.

Embark/Embarkation - To board a vessel.

EPIRB - “Emergency Position Indicator Radio Beacon” - Emergency device that sends an identifiable signal by satellite to a USCG Rescue Coordination Center.

Expansion straps (container lines) - A series of lines running around the circumference of a codend to provide strength and help maintain the shape of the bag.

F

Fathom - A measure of length or depth equal to six feet.

Fingers/Triggers - Small plastic strips located in the tunnel of a pot which allow fish to enter a pot but not exit.

Fish ticket - A record of purchase and documentation of commercial fisheries harvest from Alaska. As a general rule, fish tickets must be completed and submitted to the local office of the ADF&G for all initial sales and/or processing of fish within the state of Alaska. Observers can use fish tickets to calculate and/or document the delivery weight from a vessel.

Fishfinder - An electronic device for locating schools of fish under a vessel.

Fishing day - A 24-hour period, from 1201 hours A.l.t. through 1200 hours A.l.t., in which fishing gear is retrieved and groundfish are retained. An observer must be on board for all gear retrievals during the 24 hour period in order to count as a day of observer coverage. Days during which a vessel only delivers unsorted codends to a processor are not fishing days.

Fishing mortality - Removal (deaths) of fish from a population due to fishing activity.

Fixed gear – Non-mobile gear types. In the groundfish fishery, this includes longline, pot, and jig gear.

Flag pole - Pole with a float; often topped with a flag, radar reflector, or strobe light.

Flatfish - Fish which are laterally compressed and orient themselves in the water with their lateral surfaces or sides towards the surface and bottom and both eyes on the upper side.

Flatlink - A piece of cut or cast hardware, generally oblong in shape, with leg diameter smaller in certain areas to allow attachment of a G-hook. Used where wires must be connected and disconnected frequently.

Flood tide - Incoming tide.

Flow Scale - A scale built into a conveyor belt; the scale maintains a running tally of weight moving across the belt, in addition to comparing it to a constant weight in order to compensate for vessel movement.

Fo’c’sle (from: forecastle) - The forward part of a ship where sailor’s quarters are located.

Footrope - On a non-pelagic net; a series of bobbins, tires, or discs strung on chain or wire rope attached to the bottom front of a bottom net to protect the net from damage. On a midwater net; the rope or wire running along the front, bottom edge of the net.

Fork length - The length from the tip of the snout or jaw (whichever is most anterior) to the end of the middle rays of the caudal fin. It is the most common measurement used by the Observer Program and by NMFS researchers.

Formalin – A chemical preservative used to preserve stomach and other samples collected by the Observer program. Formalin is 37% Formaldehyde in aqueous solution.

Forward - Towards the bow of a vessel.

G

Galley - Ship’s kitchen and/or mess hall.

Gallows - Structure from which trawl blocks (pulleys) are hung; separate units port and starboard.

Gangion - The length of line that connects the hook to the groundline on longline gear. It is often only two to three feet long.

Gantry - A frame structure, usually at the aft of a vessel, which supports pulleys (blocks) used in setting and retrieving trawl nets.

G-hook - A piece of cut or cast iron hardware in the shape of a “G”, used with a flatlink where wires must be connected and disconnected frequently.

Gilson - On a trawler; a single hookline (as distinguished from a multiple block) and winch used to assist in setting, hauling, and moving gear on deck.

GOA- Gulf of Alaska Management Area.

GPS - Global Positioning System - A system of satellites, computers, and receivers that is able to determine the latitude and longitude of a receiver on Earth by calculating the time difference for signals from different satellites to reach the receiver.

Groundline/Mainline - The length of line to which all of the hooks are attached on longline gear. This line is the “backbone” of the gear.

GRS - “Groundfish Retention Standard”- Regulation requiring 80% in aggregate of all groundfish with a directed fishery to be retained when caught by non- AFA catcher/processor vessels. The retention requirement increases to 85% in 2011 and thereafter.

Gunnel/Gunwale - The upper edge of the side of a boat.

Gurdy - Special winch for hauling of longlines or trolling lines.

H

Halibut injury assessment - Assessment of injuries to halibut caught by longliners in the groundfish fisheries. These data are analyzed by the IPHC staff and used to estimate future mortality rates.

Halibut excluder - A divider located in the tunnel of a pot that restricts the size of the opening. Also, a device placed in the intermediate portion of a trawl net to exclude larger halibut.

Halibut viability - Assessment of the condition of incidentally caught halibut as they are released on a trawler or pot vessel in the groundfish fisheries. These data are analyzed by the IPHC staff and used to estimate future mortality rates.

Hanging unit - On a longliner; the unit at the end of your sampling frame that is different in size than all other units because the total number of gear segments is not

evenly divisible by the number of segments comprising a sample unit.

Harvest - The total amount of fish caught and retained from an area over a period of time.

Hatch - An opening in a deck or bulkhead of a ship.

Haul - A catch of fish from one tow of a net or longline.

Haulback - The start of retrieval to the codend being brought fully onboard the vessel.

High grading - When a vessel puts up product but later discards it overboard in favor of a more valuable product.

Hook - Usually a three pronged grappling hook used to snag the trailer buoy line.

Hook counts - The average number of hooks per segment of gear.

Horn off - To knock organisms off of a hook using the horn on the roller or the butt of a gaff.

Hydrostatic release - Mechanism designed to automatically release emergency survival equipment upon the sinking of a vessel. Hydrostatic releases are installed on life rafts and EPIRBs.

I

IFQ - “Individual Fishing Quota” -A percentage share of the TAC is assigned to vessels or persons, usually based on historical fishing effort. These shares can be sold or leased. In the fisheries off Alaska; sablefish, halibut, and Bering Sea king and Tanner crab fisheries are managed with IFQs.

Immersion Suit - A special type of waterproof suit that provides flotation and thermal insulation required for cold water emergencies such as a sinking vessel. They have built-on feet (boots), and a hood, and either built-on gloves or watertight wrist seals. An immersion suit is issued to each NMFS observer upon deployment (survival suit).

Incidental catch or species - Catch taken while fishing for the primary purpose of catching a different species.

Insulated coveralls- Water resistant coveralls worn in the cold months while sampling on deck.

Intermediate - A gradually tapered section, generally of small mesh, between the back body of a trawl and the codend.

IR/IU Species - “Improved Retention/Improved Utilization Species” - Pollock, Pacific Cod and GOA

GLOSSARY

shallow-water flatfish for which there are specific retention regulations.

J

Jig boat – Small vessels using up to 5 jig machines that dangle a maximum of 15 hooks per line at a constant depth. Target species include Pacific cod and Atka mackerel.

Joint Venture - A cooperative fishing/processing effort between vessels of different nationalities.

K

Knot - A measure of time multiplied by distance, equaling speed. One knot equals one nautical mile (6,080 feet) in one hour.

L

Landings - The total amount of fish unloaded at a buying station by commercial fishermen or brought to shore by recreational fishermen. Landings are reported at the points at which fish are brought to shore or delivered to an at-sea processing facility.

LAPP – “Limited Access Privilege Program” - A group of harvesters with exclusive harvest privileges to a fisheries resource (share-based or rationalized fisheries).

Launcher - Hydraulic lift, usually located on the port side of a vessel. Used to “launch” pots over the side of the vessel and to adjust the angle of the pot when it is being emptied.

Lay - The direction in which the strands of a rope are twisted (right or left) or the degree of tightness with which they are twisted (soft, medium, hard, etc.).

Lazaret - A storage place between the decks of a ship.

“Lead” Level 2 Observer - An observer that has met the requirements to become level 2 endorsed, and has met additional experience requirements on specific vessels and gear types.

Lee/Leeward - The side protected from the wind, opposite the “windward” side.

Length frequency data - Also referred to as sex/length data, length-frequency and/or length sample data.

Level 2 observer – An observer who has successfully completed a cruise, at least 60 days of data collection and received a “met expectations” score for their most recent cruise.

Live tanks - Tanks or bins on factory trawler vessels where the catch is dumped prior to sorting or processing. Some catcher vessels also have live tanks where the catch is dumped first, then fish are run over a conveyor belt into RSW (Refrigerated Sea Water) tanks before delivery to a processor.

Lobby - Another name for a fish bin on a catcher/processor.

Longline pots - Pots connected with line.

M

Magazine -(Mag) - On a longliner; a term used to describe a segment of gear within a set containing approximately one hundred to as many as a thousand hooks. The length of this segment of gear is dictated by the length of the magazine rack on which the hooks and groundline are hung.

Magazine rack - (Mag rack or rails) -A piece of equipment for automatically feeding hooks through an autobaiter. The hooks are hung on a bar and the gangions and the groundline then hang from the hooks.

Main Wires - The two large cables used to connect the trawl net to the vessel while fishing.

MARPOL- “International Convention for the Prevention of Pollution from Ships”- International agreements designed to control at-sea disposal of wastes.

Master - The captain of a vessel or one in charge of the fishing activity.

Material Safety Data Sheet (MSDS) - Forms containing data regarding the properties of a particular substance intended to provide workers and emergency personnel with procedures for handling or working with that substance in a safe manner, and includes information such as physical data, toxicity, health effects, first aid, reactivity, storage, disposal, protective equipment, and spill handling procedures.

Maturity stage - Period in the reproductive life cycle, often determined by visual examination of the gonads.

Mid-cruise – Meeting with Observer Program staff to review the observer’s sampling procedures, calculations, and collected data to ensure that all is going well during his/her deployment. This interview usually takes place early in the observer’s cruise to allow the observer opportunity to incorporate suggestions and make improvements on his/her data collection efforts.

Mothership - At sea processing vessel (under way) whose fish come from catcher boat deliveries.

Motion Compensated Platform Scale (MCP) - An electronic flatbed scale with a constant weight load cell which allows for compensation of the vessel's movement.

MSY - "Maximum Sustainable Yield" - An estimate of the largest average annual catch or yield that can be taken over a significant period of time from each stock under prevailing ecological and environmental conditions. Since MSY is a long term average, it need not be specified annually.

N

Net reel - A hydraulic drum on the deck on which the net and most of the rigging are wound.

Non-fishing day - A day that had no hauls or sets retrieved. These days are documented on the Vessel Haul Form with the location of the vessel at or around noon that day.

O

Observer estimate - Unbiased, independent estimate of total catch weight made by the observer.

Observer Provider - (also known as contractor) - Any person or commercial enterprise that is granted a permit by NMFS to provide observer services to vessels, shoreside processors, or stationary floating processors for observer coverage.

Offload - (delivery) - When a catcher vessel transfers their catch to a shoreside plant or floating processor.

Offload salmon retention count - A count of all salmon in a pollock delivery completed at the plant by the vessel observer or plant observer, including any salmon at-sea discards, and reported on the Salmon Retention Form.

Otolith - In fish; calcium carbonate structures located ventrally, and to either side, of the brain tissue, just above the pre-operculum. These structures can be removed and used to determine the age of the fish.

Otter trawl - The type of net gear used on stern trawlers

Otterboard - Another name for a trawl door.

OY - "Optimum Yield" - The harvest level for a species that achieves overall benefits including economic, social, and ecological considerations.

Overcapitalization - A level of investment resulting in a non-economically productive fishing effort level (too much effort may drive down economic profits).

Overfishing - Harvesting at a rate that will exceed the management goal or an amount of fishing mortality that jeopardizes the capacity of a fishery to produce MSY on a continuing basis (MSFCMA definition). An overfishing level (OFL) is determined for every species or species group for which there is a TAC.

P

Panel - Mesh netting attached to a square metal frame. Two large panels and four smaller panels are attached to a heavy steel frame box to form the six sides of a pot

Paravane - An alternative to the third-wire net monitoring equipment that requires a cable to be deployed between the ship and the net monitoring equipment on the headrope. A paravane is a hydrophone receiver and boomed out alongside the vessel, set to fly from 5-15 fathoms deep. Also known as a "water kite."

Parent sample - The sample from which the subsample was taken. A subsample is taken from within or near the parent sample and a specific numbering convention is used to associate a subsample to the parent sample.

Pelagic - Midwater.

Peritoneum - The lining of the gut cavity.

Pew, Pew stick - A sharp-ended pole which is used to skewer fish and toss them to another location.

PFD - Personal Flotation Device - A buoyant or inflatable garment for supporting the wearer in deep water and thus serving to prevent drowning.

Pick/"Running the hook" - Hook connected to the end of the boom which is attached to the bridle and is used to lift a pot onto the launcher as the pot is being retrieved.

PLB - "Personal Locator Beacon" - Issued by the Observer Program to every observer, PLBs are GPS equipped units, that when activated, send GPS coordinates along with an identifiable 406 MHz alphanumeric signal to the SARSAT/COSPAS system.

Plotter - Electronic mapping device that displays the local area and the vessel's position on it. The plotter allows captains to record the area of a string and also the number of pots in a string on a digital map display.

Pod - A school of marine mammals such as seals, whales or dolphins.

Point of Collection - Area on a groundfish vessel where the observer collects unsorted catch.

GLOSSARY

Population - The total of individuals occupying an area or making up a whole. When sampling aboard a trawler, a population is defined as the catch from a single haul.

Port - A town or city having a harbor for ships taking on or discharging cargo. Also, the left side of the vessel when facing forward

Porthole - A window in the hull or the outside bulkhead of a ship.

Pot tie - A short piece of line used to tie pots together when they are stacked on deck.

Pre-anal fin length - The measurement from the tip of the snout to the insertion of the first anal fin ray, immediately posterior to the anus. This is the length measurement used by the Observer Program for grenadier.

Predominant species - Species which are the most abundant in the catch; as determined by using either a visual count or weight estimate. This may not be the target species.

Presorting - The segregation and/or removal of any item(s) or organism(s) from the catch prior to the point where an observer is collecting a sample.

Prohibited species or prohibited species groups - Species whose allowable retention is zero. Salmon, herring, halibut, king crab, and Tanner crab are always prohibited in North Pacific open access groundfish fisheries. For vessel operators; prohibited species include the above and any other species declared prohibited by a notice of closure.

PRR - "Product Recovery Rate" - Represents that proportion of an organism that is used for product. PRRs can be used for estimating the round weight of a catch from the tonnage of product produced.

PSC - "Prohibited Species Catch" - A harvest limit usually placed on halibut, salmon, crabs or other species which must be discarded in the groundfish fisheries.

Q

No entries.

R

Radio Call Sign - Alpha numeric code used as an international identifier of a vessel when using the ship's radios.

Rail - On a longliner; a term used to describe a segment of gear within a set containing approximately 300 hundred to as many as 1,100 hooks. The length of this segment

of gear is dictated by the length of the magazine rack on which the hooks and groundline are hung.

Random - Relating to a set, each of whose elements have an equal probability of occurring in a sample. These elements are chosen as sample units in a manner which eliminates subjectivity.

Random sample design - The method of sampling a population where all of the elements have an equal probability of occurring in the sample.

Raw data - The original data collected by the observer while sampling. This data is documented on the Deck Form.

Regenerated scale - A fish scale which has grown in to replace one that was lost. Regenerated scales are useless for aging a salmon, but can be used to identify it to species.

Research project data - Short term data collection projects that are submitted annually to the Observer Program. These projects meet our program mission goals and the data collected contributes to the understanding and managing of the marine resources.

Reserve - A portion of quota set aside at the beginning of the fishing year to allow for uncertainties in preseason estimates of Acceptable Biological Catch (ABC).

Retained species - Organisms that are retained in whole or part by the vessel for any reason, including consumption on the vessel, processing, delivery, bait, or personal use.

Riblines - Heavy lines or chains that run down the length of the trawl net to strengthen it.

RKCSA - "Red King Crab Savings Area" - An area restriction in the Bering Sea closed to non-pelagic trawling year round, except for a subarea that may be opened at the discretion of the Council and NMFS when a guideline harvest level for Bristol Bay red king crab has been established.

Rockfish Program- See "Central Gulf Of Alaska Rockfish Program".

Roller - A device made up of one or more metal pins that spin allowing the groundline to be pulled up and over the rail of a vessel during retrieval such that tension and friction on the line is reduced.

Roller station/pit - Term used to describe the area where fishermen stand while retrieving the line and gaffing fish coming in over the roller.

Rollerman - A crewman who stands in the roller station and monitors the retrieval of the gear. The rollerman lands any commercially valuable fish and excludes any non-commercially valuable fish from being landed.

Rostrum - A pointed, calcareous, median extension on the anterior end of crab carapaces.

Round weight - The weight of the whole fish (or animal) as it was when alive, synonymous with fresh weight and whole weight.

Roundfish - Fish that orient themselves in the water with the dorsal side towards the surface and ventral side towards the bottom and eyes on each side of the head.

RSW - Refrigerated sea water, usually referring to a tank for holding fish.

RSW Tanks - Holding tanks or bins that use refrigerated sea water to keep fish fresh until delivery.

Running line - The length of line connecting the anchor to the baited gear.

“Run pots” - A phrase used interchangeably with “retrieve pots.” It is the phrase used in the vessel logbook to indicate the number of pots that have been retrieved from a string.

S

Safety orientation – instructions given by a qualified crew member to all new vessel personnel (observers included) concerning the safety equipment and procedures aboard the vessel. This is required under 46 CFR Part 28.270 and 50 CFR Part 28.265.

Sample size - The portion of the population that is sampled (measured in weight or amount of gear).

Salmon retention - BSAI vessels and processing plants are required to save all salmon from Bering Sea directed pollock fishing on a haul by haul or delivery basis until these salmon are counted by a NMFS-certified observer. The observer reports the data on the Salmon Retention Form.

Sample station – Area on a vessel where the observer processes (counts, weighs, measures, etc.) samples. On trawl catcher processors and motherships, the sample station is required to be inspected and approved by the Observer Program. In the longline CDQ fisheries, the sample station on catcher processors is required to be inspected and approved by the Observer Program.

Sample weight - The actual weight in kilograms of a composition sample.

Sampling - The process of selecting part of a population for the purpose of determining the parameters, or characteristics, of the whole population and recording data regarding all individuals in the population. Composition sampling refers to taking samples of a haul in order to determine the fishing mortality of species occurring in the sample.

Scupper - A hole in the bulwarks which allows water to drain from the deck.

Seabird deterrence (seabird avoidance) – Measures to avoid seabird bycatch by groundfish fishing vessels. These are required by regulation for longline vessels and include offal discharge restrictions and the use of streamer lines.

Segment of gear - In this manual a segment of gear refers to the standard unit a longline vessel uses for measuring gear. This could refer to a mag, skate, tub, or coil of gear.

Set - The entire length of groundline from the first hook to the last hook, also referred to as a “string” of gear.

Setting chute - A metal trough that guides baited longline gear out of a hatch or off the stern of the vessel.

Sex/length data – Sample collected by observers in which the sex and fork length are documented and entered into the database.

Sheave - A wheel with a grooved rim and mounted in a pulley block to guide the rope or cable.

Short-wiring - Occurs when a codend is brought from fishing depth to near the surface, the trawl doors are held at or above the surface, and the net is towed behind the vessel until it is brought on board.

Shot - A pre-measured length of buoy line, usually 10 to 20 fathoms long. Normally there are two set lengths, a “Long” shot and a “Short” shot. When setting a string, the captain will tell the crew how many shots to tie to a pot for various bottom depths.

Skate - A segment of longline gear containing approximately 100 to as many as 300 hooks.

Skate bottom - A fabric square with lines on the corners to tie it into a bundle once a longline “skate” has been coiled onto it.

Skate/Mag markers - Markers in the groundline that separate the sections of gear. These may be fluorescent

GLOSSARY

tape woven onto the line, knots, line splices, carabiners, or magazine (mag) clips.

Skates/Tubs/Coils - Terms used to describe the smaller segments of gear within a set or a magazine.

Spatial - Referring to a unit of space used in random sampling. For example: a third of a bin, or a section of trawl alley are spatial units.

Species composition sample - To sort a defined weight of catch such that each organism sampled for is grouped by family or by species and to determine the number and weight of the organisms in each group.

Spring line - A mooring line attached amidships.

SRS - "Simple Random Sample" - A basic type of sampling design where random numbers are selected from the population and each member of the population is equally likely to be chosen at any stage in the sampling process.

SSB - "Single Side Band" radio used for long distance contact.

Stack - This term is used on pot vessels to refer to pots stacked on the back deck.

Starboard - The right side of a ship (when one is looking forward).

Stern - The aft or back end of a vessel.

Stern ramp (slip) - A sloping ramp in the stern of a trawler between the deck and the water line, through which the net is set and hauled.

Stern trawler - Any of various sized fishing vessels which trawl a conical shaped mesh net through the water, haul it up a ramp through the stern of the ship, empty, and process the catch to make a wholesale fish product. These vessels may fish for a month or more at sea without support.

Stock - A grouping of fish usually based on genetic relationship, geographic distribution and movement patterns; managed as a unit of fish.

Stock assessment - An evaluation of the size and/or health of a predefined population including all activities that fishery biologists do to describe the conditions or status of a stock; the result is a report on the health of a stock and recommendations that would maintain or restore the stock.

String - Pots deployed individually and are not attached to one another in any way. This term refers to pots set at

a similar time in a similar area and depth. What a captain calls a string varies considerably between vessels. Strings are analogous to sets.

Subsample - A sample that provides specific information about a species composition sample (parent sample). On a trawler; a subsample must be random. It is used when there are two predominant species not weighed or counted in the parent sample. On a longliner; a subsample is used to provide weight and other biological information for the target species, and weight information for other species when the observer was not able to collect enough in the parent sample.

Subset sample - A random sample taken within a species composition sample that provides a weight and/ or number of a species when they are too numerous to count or weigh, or for the identification of individuals of a species group which are difficult to distinguish from one another. Specific rules apply according to the vessel type and the species.

Surimi - Minced fish meat paste usually produced from pollock.

Systematic - Refers to methodical sampling throughout an entire population..

T

Table - Some vessels have a sorting table on the back deck that pivots on one axis. The contents of a pot are dumped onto the table, and the table is swung out of the way to re-launch the pot.

TAC - "Total Allowable Catch" - Annual recommended harvest levels based on biological, economic, and social factors that is still within the range of the ABC.

Take (MM) - The incidental catch or harassment of a marine mammal by a vessel. A take may or may not lead to a fatality.

Tally data - Species identifications and counts gathered during the tally period on a longliner.

Tally period - Segments of time on a longliner when the observer counts and identifies organisms as they come up on the hooks.

Tally station - Area on a longliner where the observer counts and identifies organisms as they come up on the line. In the CDQ fisheries, the tally station on catcher processors is required to be inspected and approved by the Observer Program.

Taper - To cut webbing according to a given formula for fitting into a trawl.

Tare - A deduction from gross weight to obtain net weight. Usually made to allow for the weight of a container.

Target species - For Observer Program purposes, the target species is what the vessel claims as their target. The Sustainable Fisheries Division of the NMFS Alaska Region uses delivery and production data to determine target fishery, which may differ from what the vessel claims as their target. Vessel personnel will generally call target species the species they wish to catch.

Temporal - Referring to a unit of time

Tender vessel - Vessels that receive catch from catcher boats and deliver it to a processing plant

Third wire - Cable extending from the vessel to the trawl sonar system attached to the head rope of the trawl net.

Tote - Large PVC containers used to separate and store catch on fishing vessels and at processing plants.

Trawl - A cone shaped net, towed through the water to catch fish.

Trawl Alley - The central passage on a trawl vessel where the codend is placed after haulback.

Trawl Doors - Often referred to as “doors,” these are two metal plates, each attached to a main wire, designed to keep the mouth of the net open while fishing.

Trip - Any time a vessel unties from the dock at a port, floating processor, or tramper, and upon completion of that trip the vessel returns and ties up to a dock in a port, at a processor or a tramper.

Tunnel - Short mesh-lined openings on two or three sides of a pot. These are the entrances to the trap.

Turning/Overhauling gear - Term used on longliners to describe the work to straighten hooks, replace gangions, or repair damaged groundlines.

U

Under way - Vessel in forward motion, running. According to Coast Guard regulation, a vessel is under way if it is not at anchor or at dock, so a vessel adrift is technically under way.

V

Vessel permit - A code used by the National Marine Fisheries Service to identify a vessel.

Verify - To determine or test the truth or accuracy of, as by independent comparison, investigation, or reference.

Vessel Strike (seabirds) - Incidental seabird mortality due to a bird or flock of birds colliding with a vessel. It appears that birds may become confused, primarily at night during inclement weather, and when bright lights are being used.

W

Warp (main wire) - The cables on a trawler which run from the main winches to the trawl doors on the net.

Watertight door - a door or hatch on a ship that, when closed, blocks the passage of water and withstands its pressure. These doors are vital to control and prevent flooding.

Weighed sample - The catch sampled by the Observer and weighed on a scale.

Weight data (longliner) - Species identifications, counts, and weights of organisms that were collected during the tally period or collected as a subsample. This task is accomplished during the non-tally period after completion of the tally.

Wheelhouse - The control center of the ship (bridge).

Winch - A hydraulic machine with one or more drums on which to coil rope, chain, or cable for hauling or hoisting.

Wing - The sides off a trawl net near the opening, usually with larger mesh than the rest of the net.

Wrister - A coated vinyl sleeve worn on the arm, extending from the elbow and covering the wrists. Keeps arms warm and dry. Fish blood and slime are more easily washed out from these than from shirt sleeves.

X,Y,Z

No entries.

This page intentionally left blank